

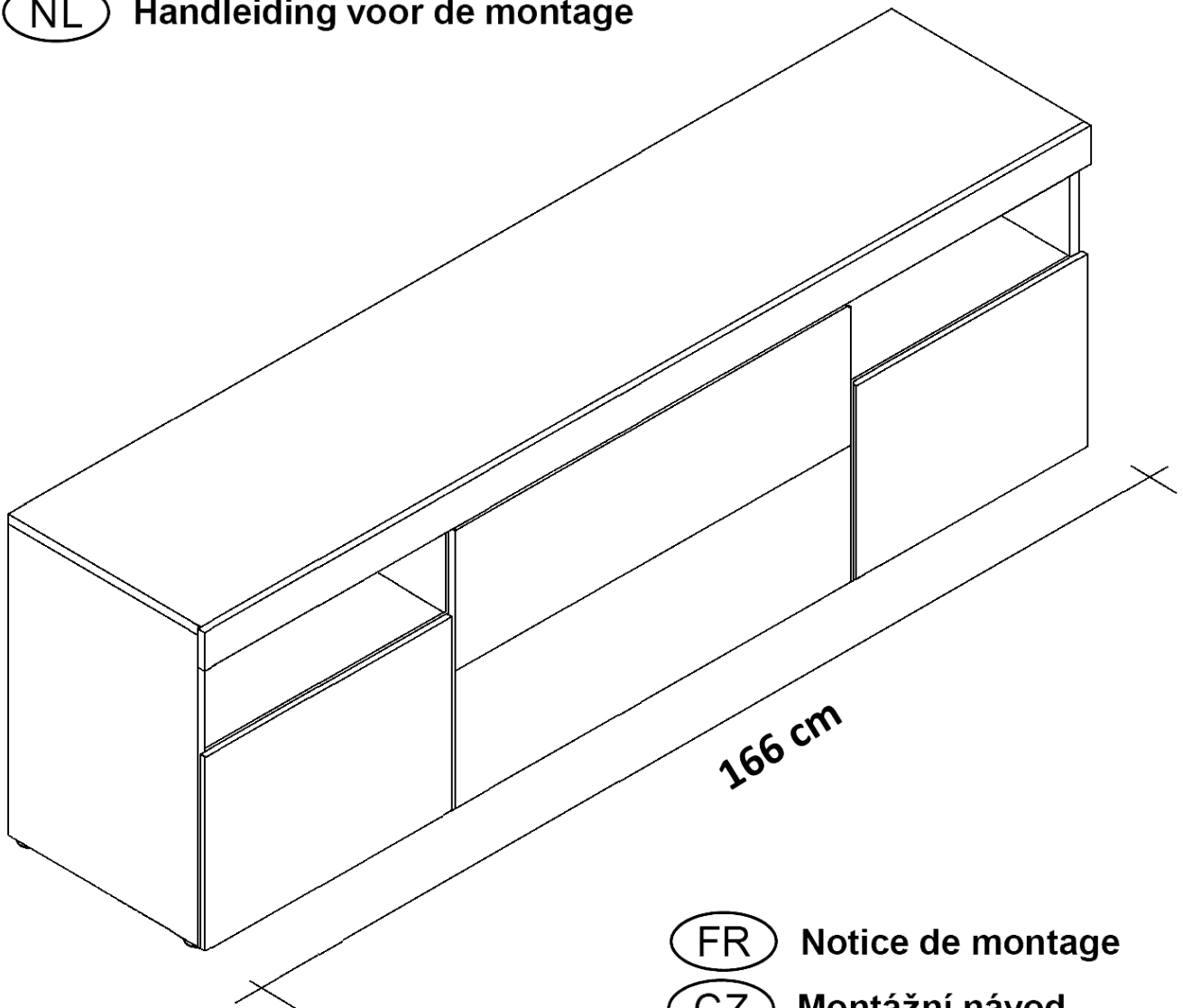

- D **Montageanleitung**
- GB **Assembly instructions**
- NL **Handleiding voor de montage**



- HU **Szerelési útmutató**
- PL **Instrukcja montażu**
- RO **Instrucțiuni de montaj**

- FR **Notice de montage**
- CZ **Montážní návod**
- TR **Montaj talimatı**
- IT **Istruzioni di montaggio**
- SK **Návod na montáž**
- RU **Инструкция по монтажу**





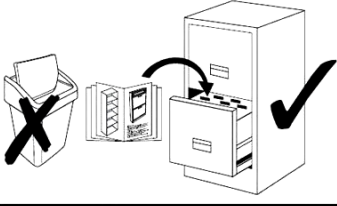
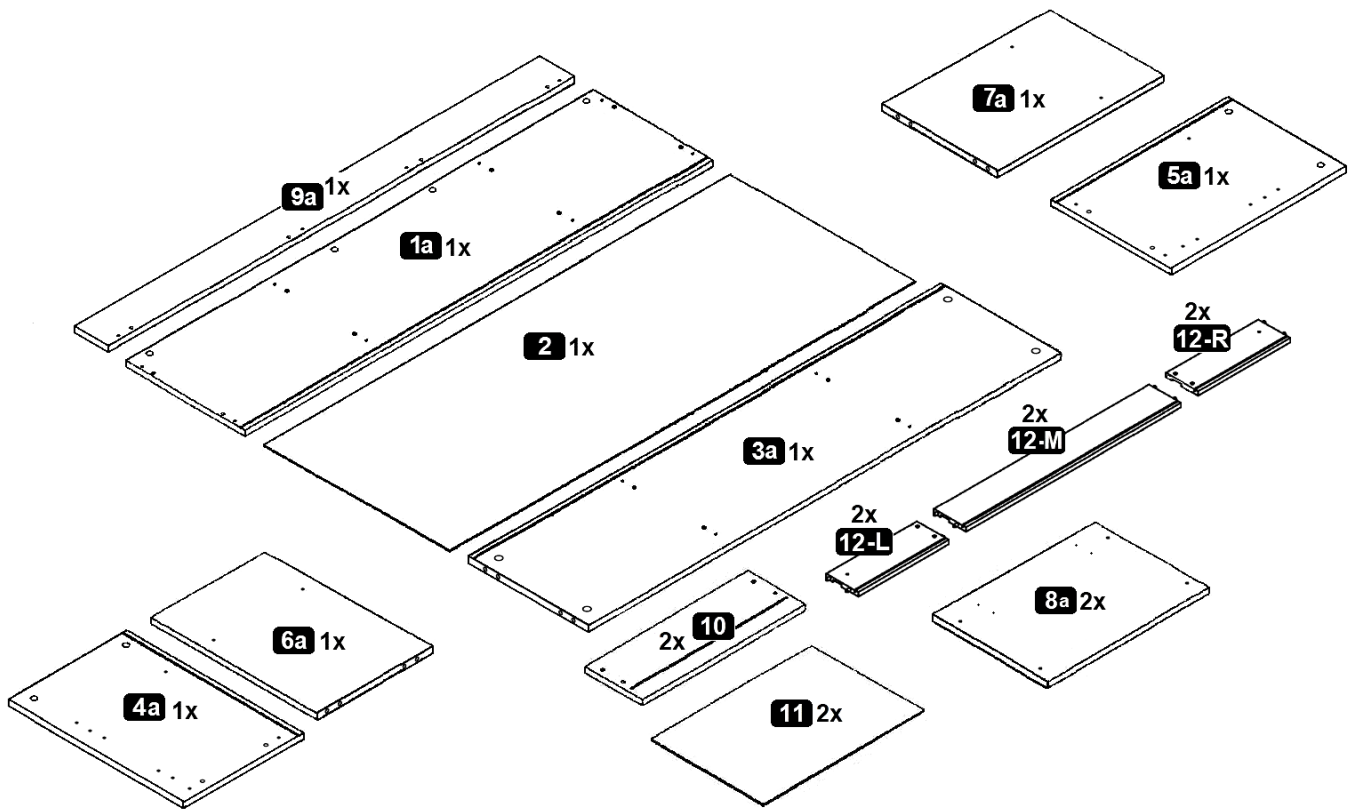
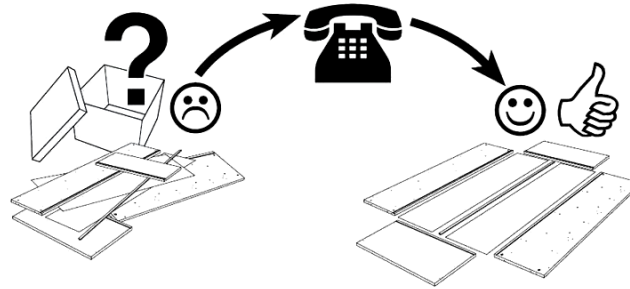









**Service • Assistenza • Dienstverlening • Serwis  
Servis • Szerviz • Сервисная служба**

Name • Nom • Nome • Naam • Nazwa • Jméno • Názov • Név • Denumire • Ísim • Название	
Nr. • No. • N° • Номер • Č • Sz	
Typ • Type • Tip • Típus • Тіро • Тип	
	

<b>1a</b>	1x	ca. 1665 x 330 mm
<b>2</b>	1x	ca. 1646 x 468 mm
<b>3a</b>	1x	ca. 1634 x 326 mm
<b>4a</b>	1x	ca. 471 x 330 mm
<b>5a</b>	1x	ca. 471 x 330 mm
<b>6a</b>	1x	ca. 456 x 311 mm
<b>7a</b>	1x	ca. 456 x 311 mm

<b>8a</b>	2x	ca. 437 x 311 mm
<b>9a</b>	1x	ca. 1665 x 60 mm
<b>10</b>	2x	ca. 737 x 209 mm
<b>11</b>	2x	ca. 707 x 307 mm
<b>12-L</b>	2x	ca. 310 x 88 mm
<b>12-M</b>	2x	ca. 695 x 88 mm
<b>12-R</b>	2x	ca. 310 x 88 mm
<b>13</b>	2x	ca. 459 x 326 mm

<b>A</b>  8,0 x 30 mm <b>20x</b>	<b>B</b>  <b>20x</b>	<b>C</b>  <b>20x</b>	<b>D</b>  3,9x9,5mm <b>6x</b>	<b>E</b>  h=2 <b>4x</b>	<b>F</b>  Ø35 Kr.0 <b>4x</b>	<b>G</b>  <b>1x</b>
<b>H</b>  4,0 x 20 mm <b>6x</b>	<b>I</b>  <b>6x</b>	<b>J</b>  2,7 x 20 mm <b>4x</b>	<b>K</b>  6,3 x 13 mm <b>8x</b>	<b>L</b>  17 x 310 mm <b>4x</b>	<b>M</b>  M4,0 x 9 mm <b>4x</b>	<b>N</b>  <b>8x</b>



# 1

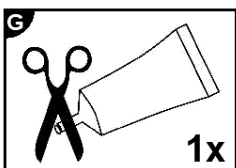
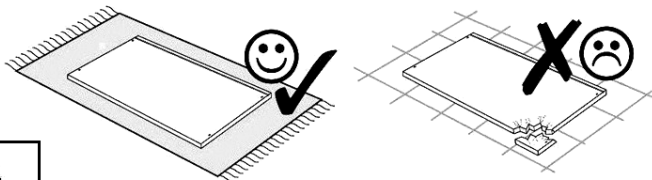

- D Leim
- GB Glue
- FR Colle
- IT Colla
- NL Lijm
- PL Klej
- CZ Lepidlo
- SK Glej
- HU Enyv
- RO Adeziv
- TR Tutkal
- RU Клей

## 4x

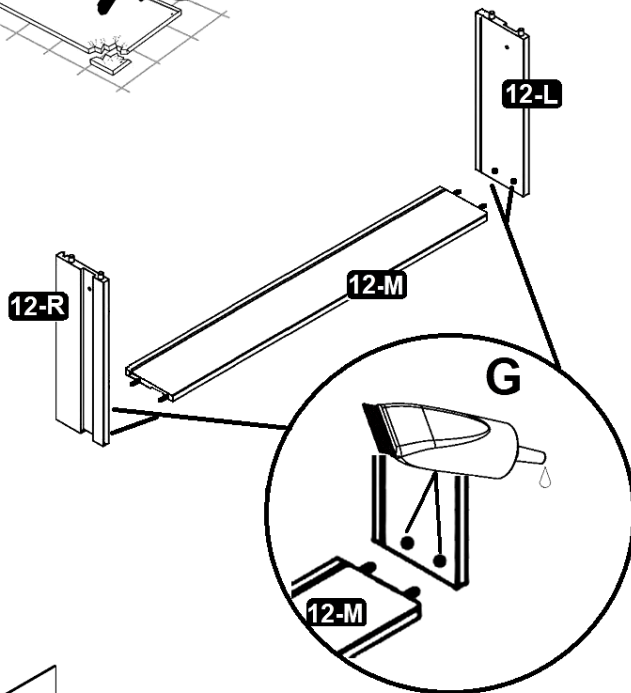

## 4x

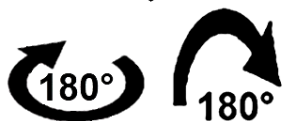
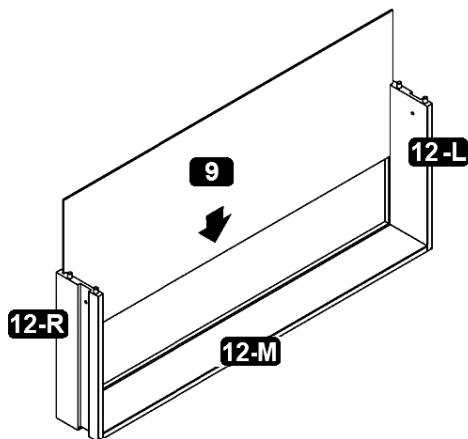

## 4x

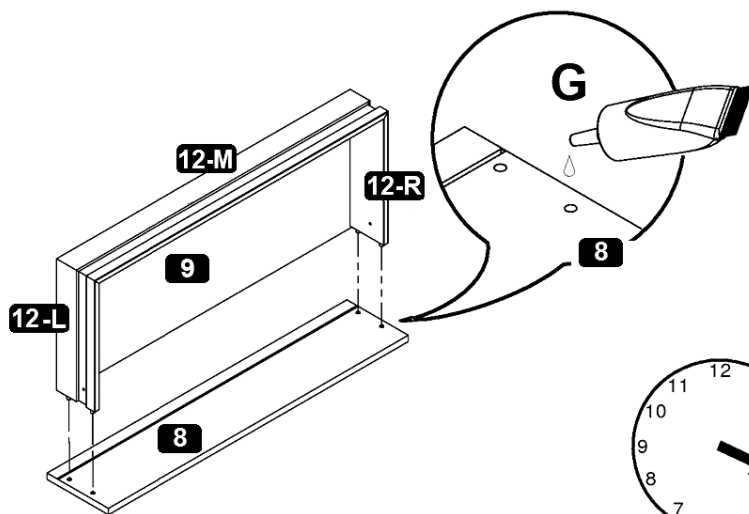

20min

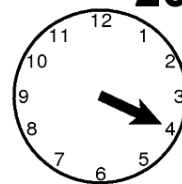

**2**

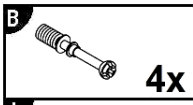
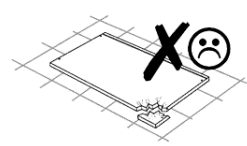
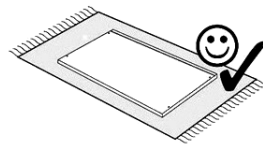
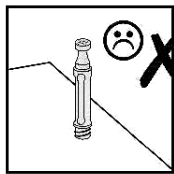
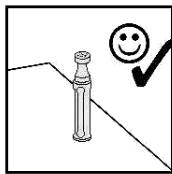

4x

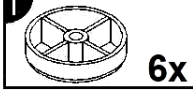

6x

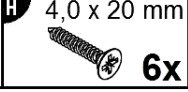

4,0 x 20 mm

6x

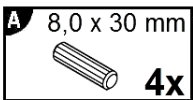

8,0 x 30 mm

4x

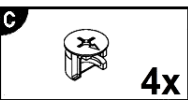

4x

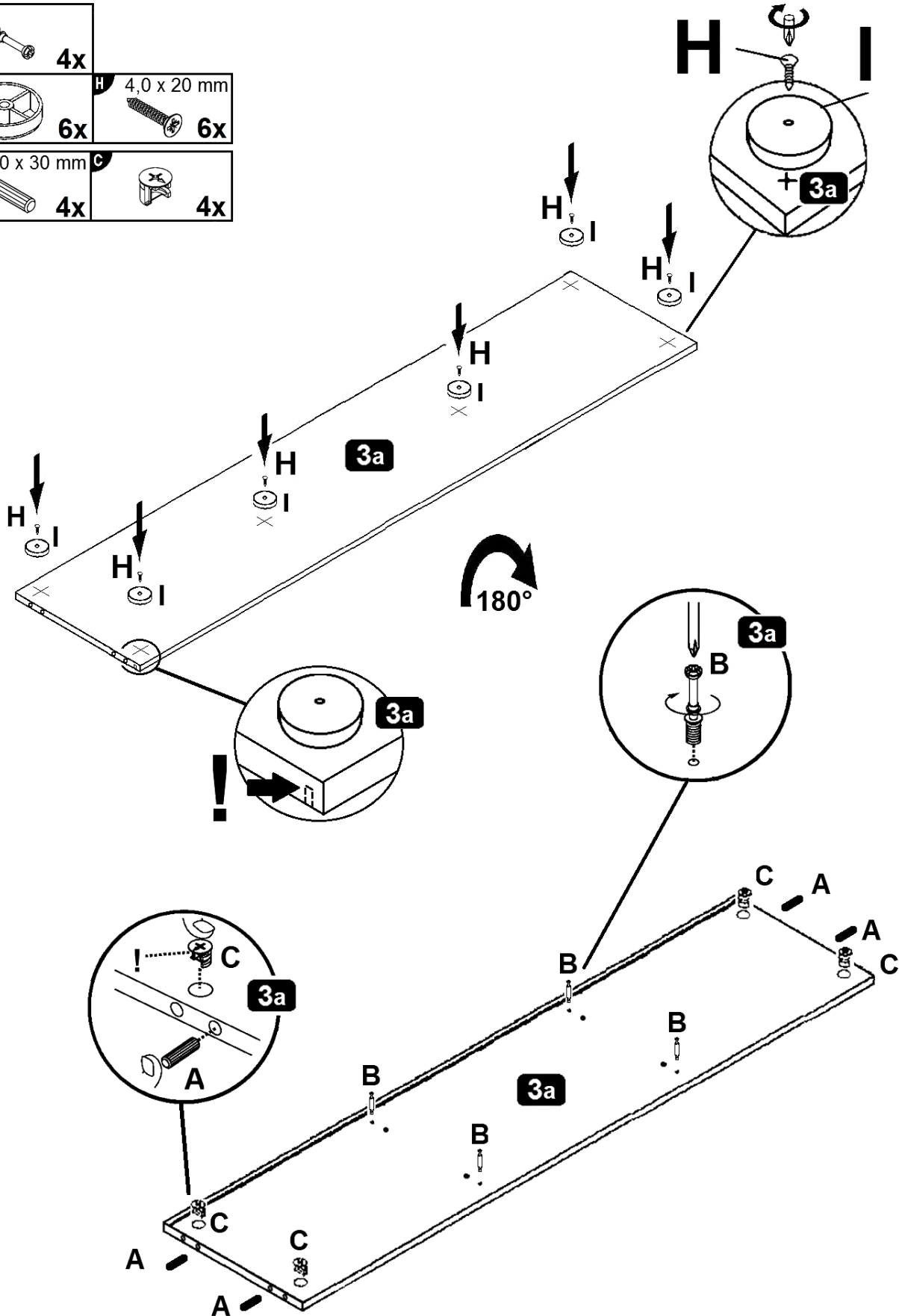

# 3

- A 8,0 x 30 mm B 4x
- B 12x
- C 4x

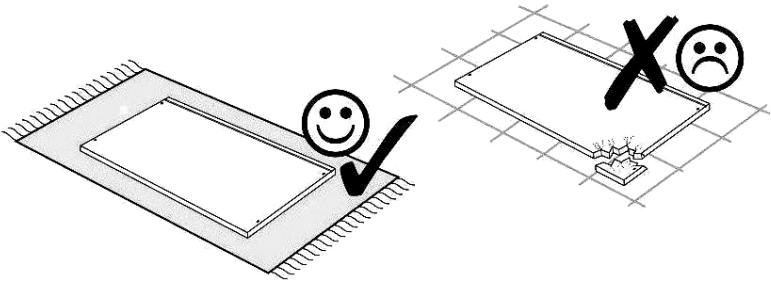
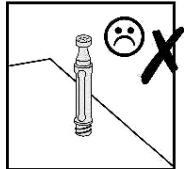
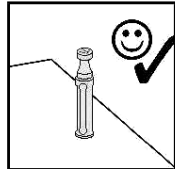

## 1.!

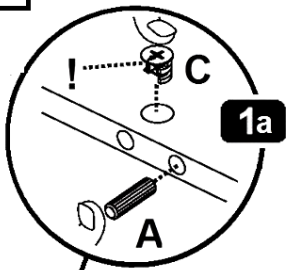

## 2.!

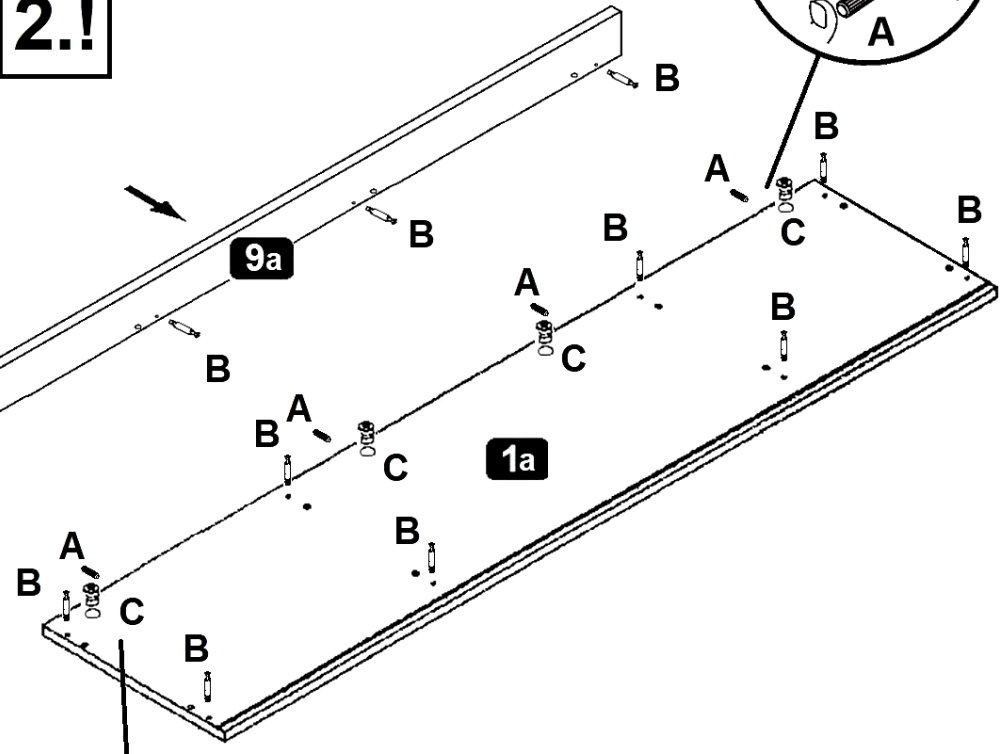
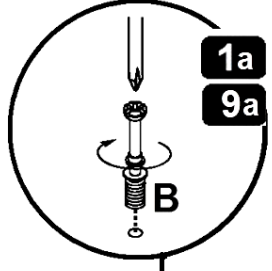

## 3.!

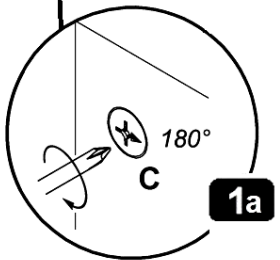

**4**

**A** 8,0 x 30 mm **4x**



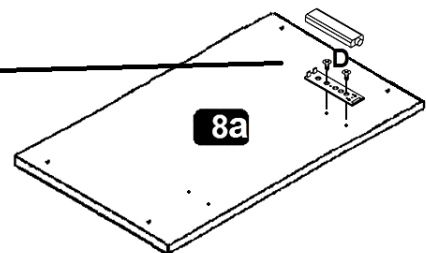
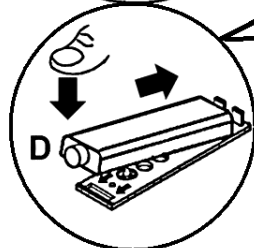
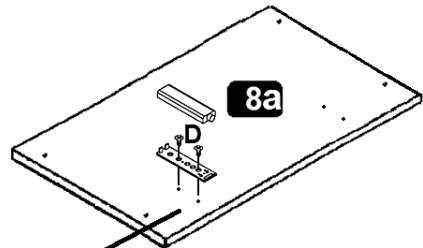
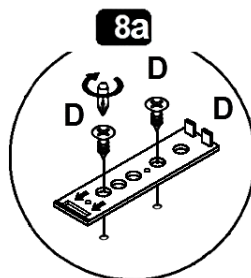
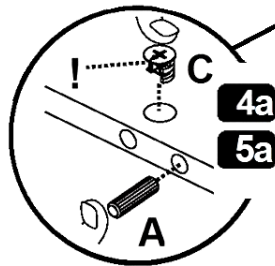
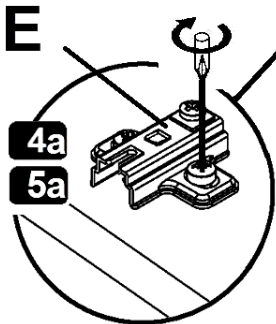
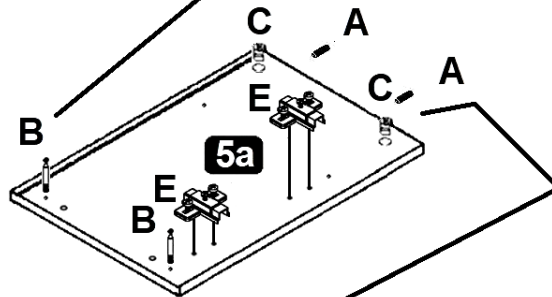
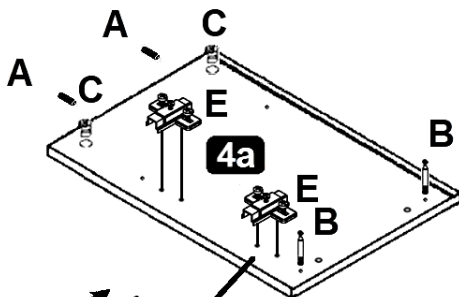
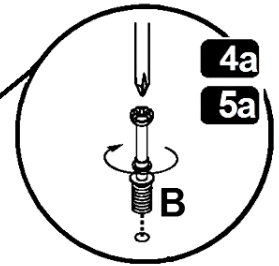
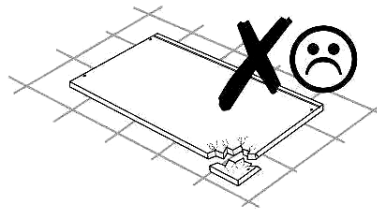
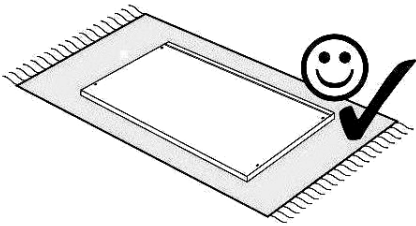
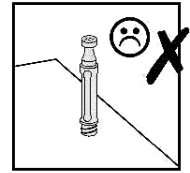
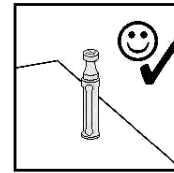

**B** **4x**

**C** **4x**

**D** 3,9x9,5mm **2x**  
h=2 **4x**

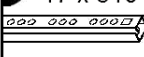

# 5

<b>A</b> 8,0 x 30 mm  8x	<b>C</b>  8x	<b>D</b>  4x	<b>K</b> 6,3 x 13 mm  8x	<b>L</b> 17 x 310 mm  4x
--	---	---	--	---

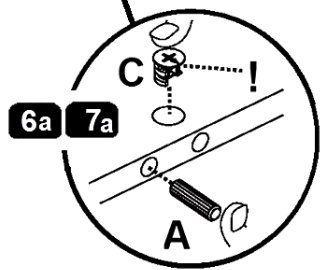
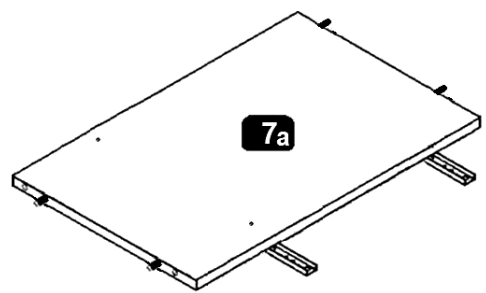
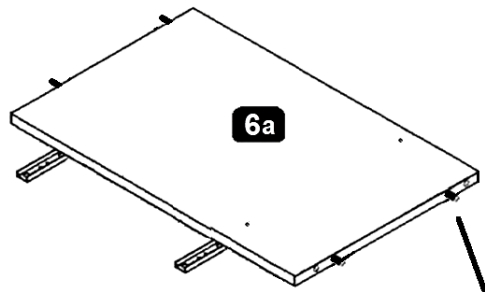
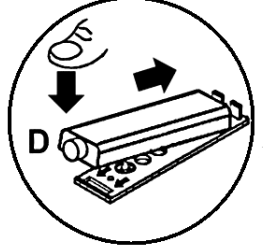
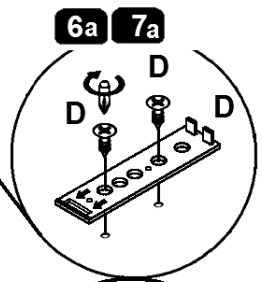
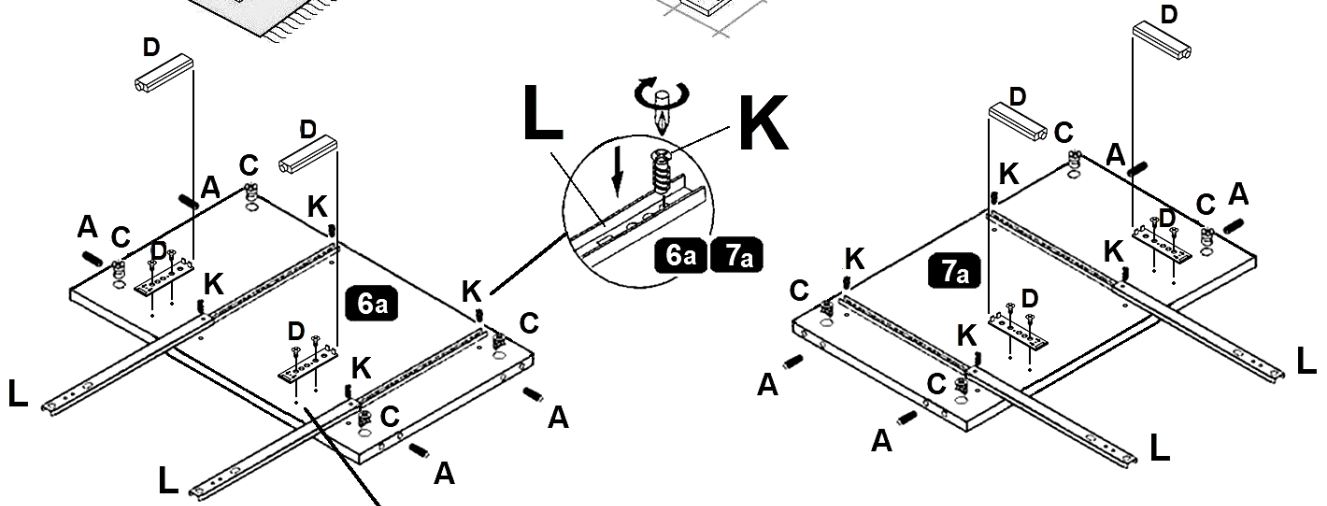
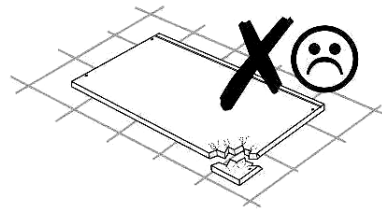
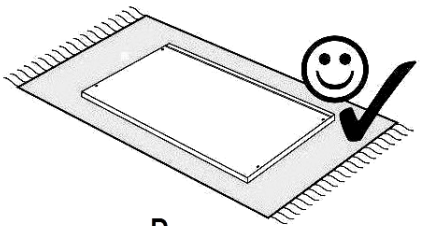



**6**

Ø35 Kr.0  
3.5x13mm **4x**

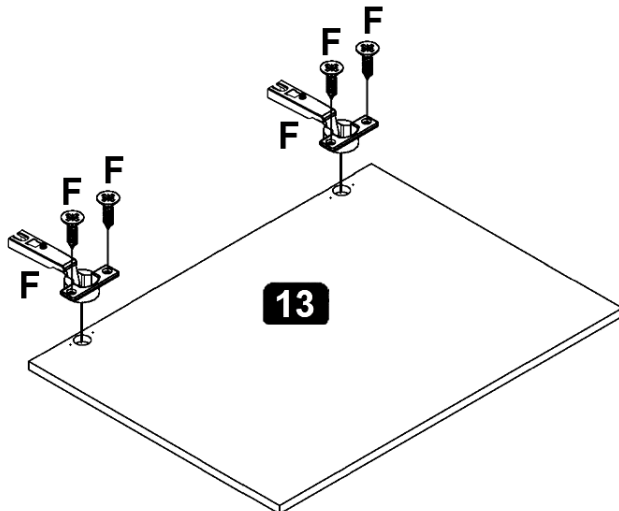
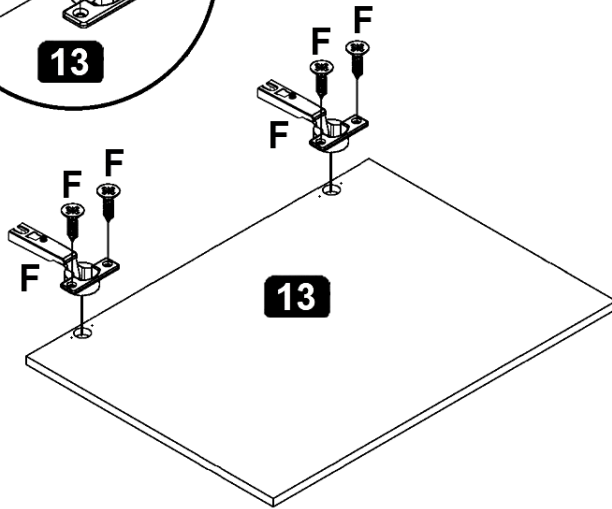
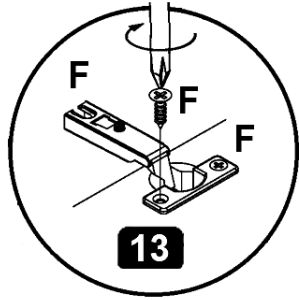
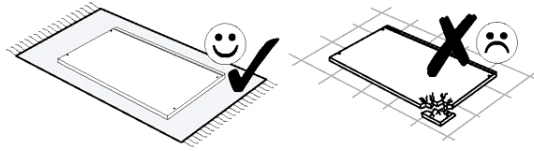



# 7

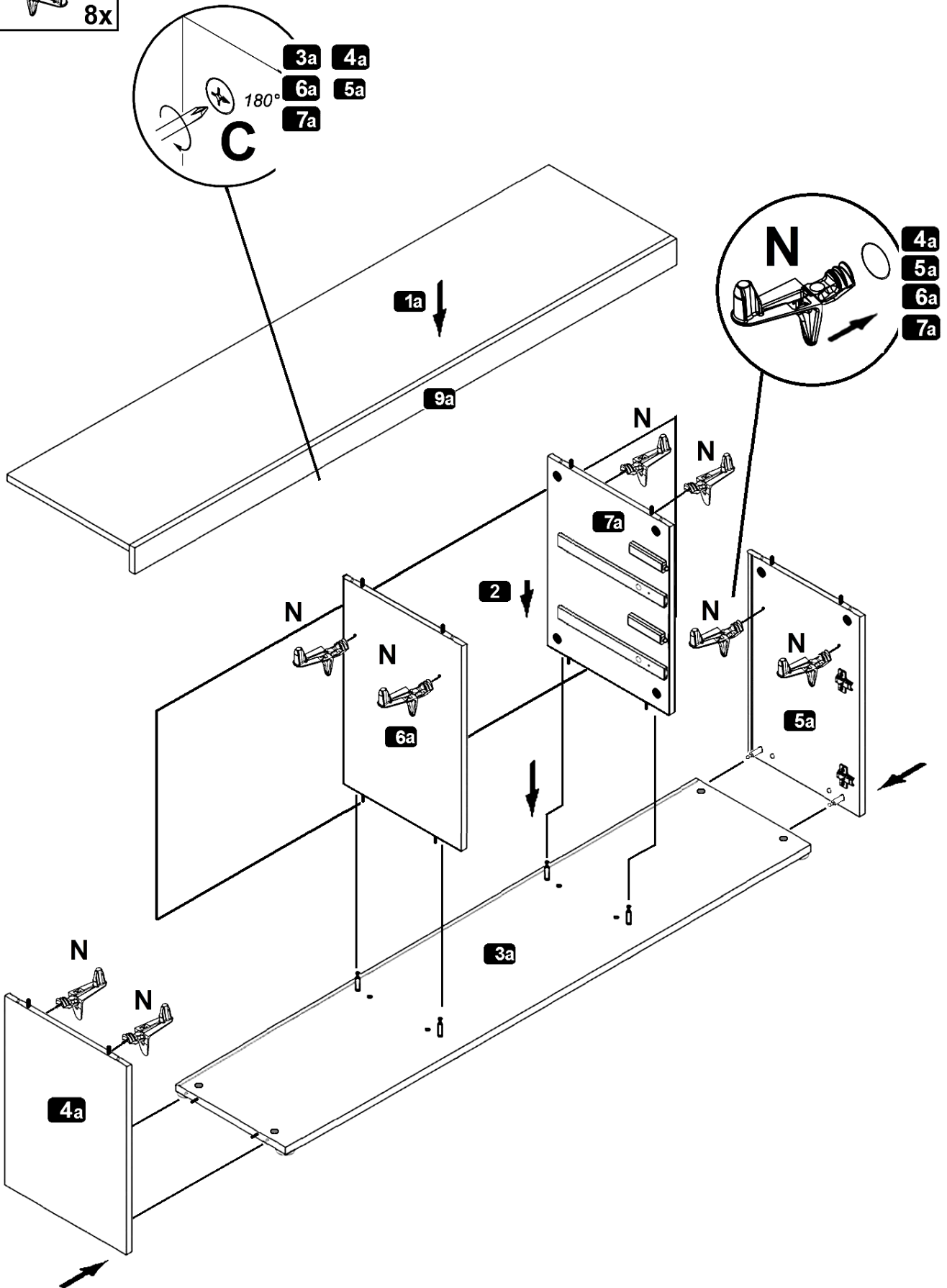
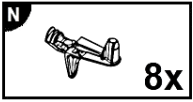

# 8

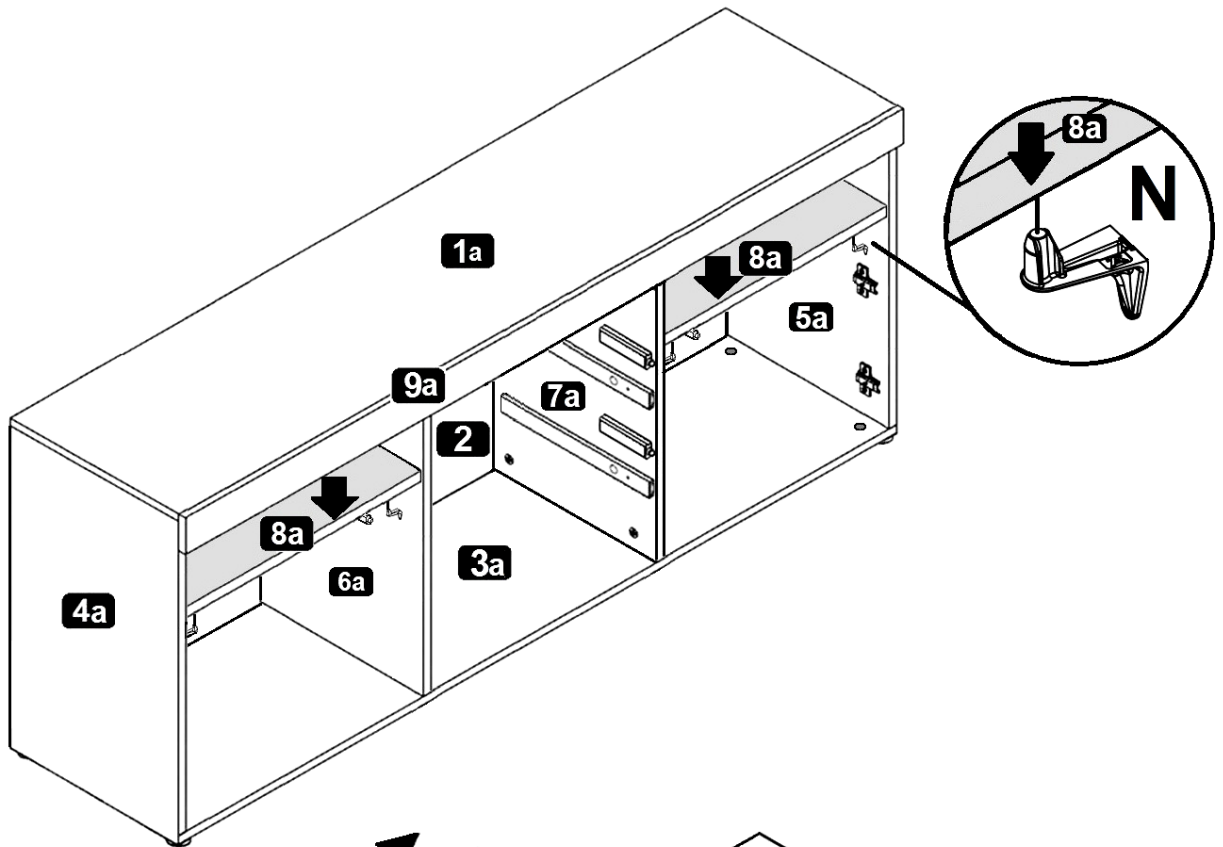

180°

# 9

J 2,7 x 20 mm  
4x

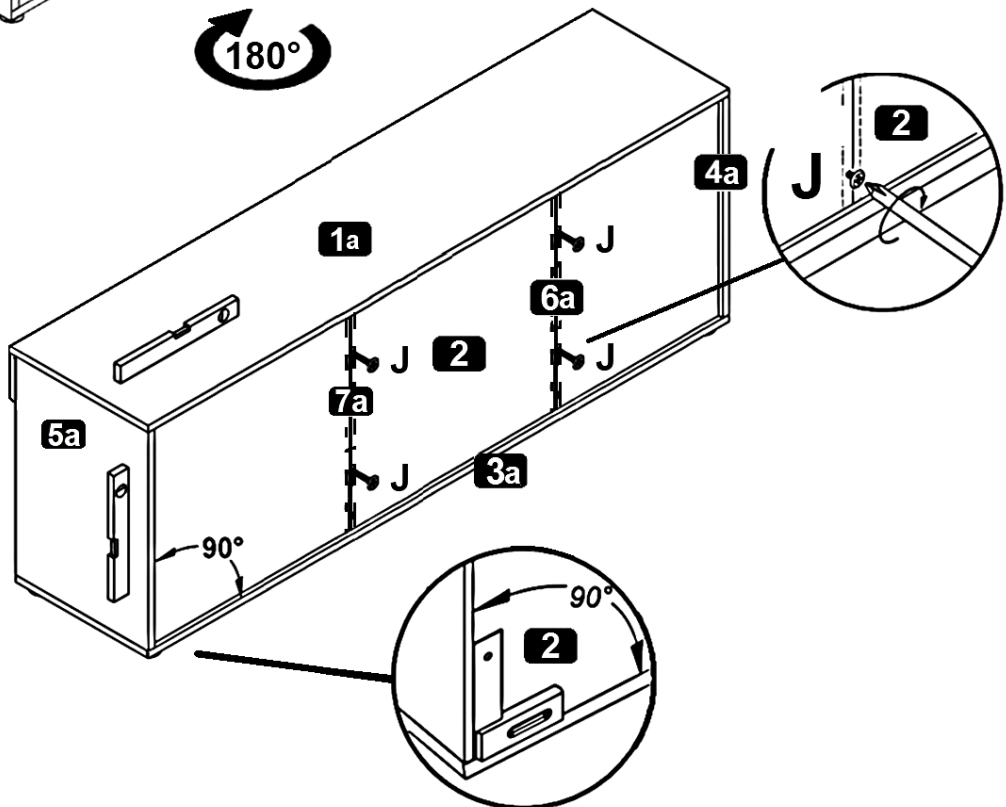

**10**

M M4,0 x 9 mm  
4x

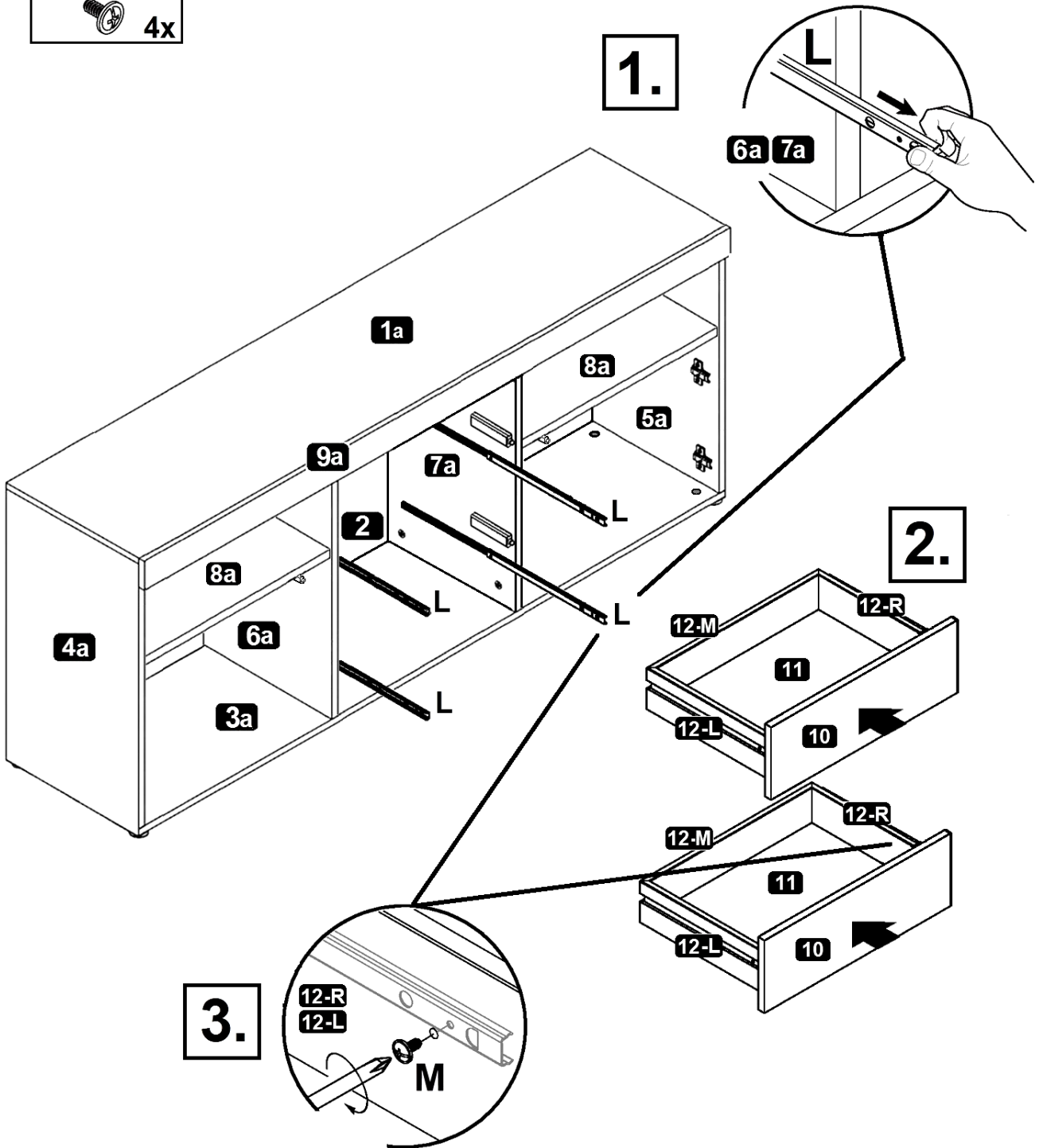

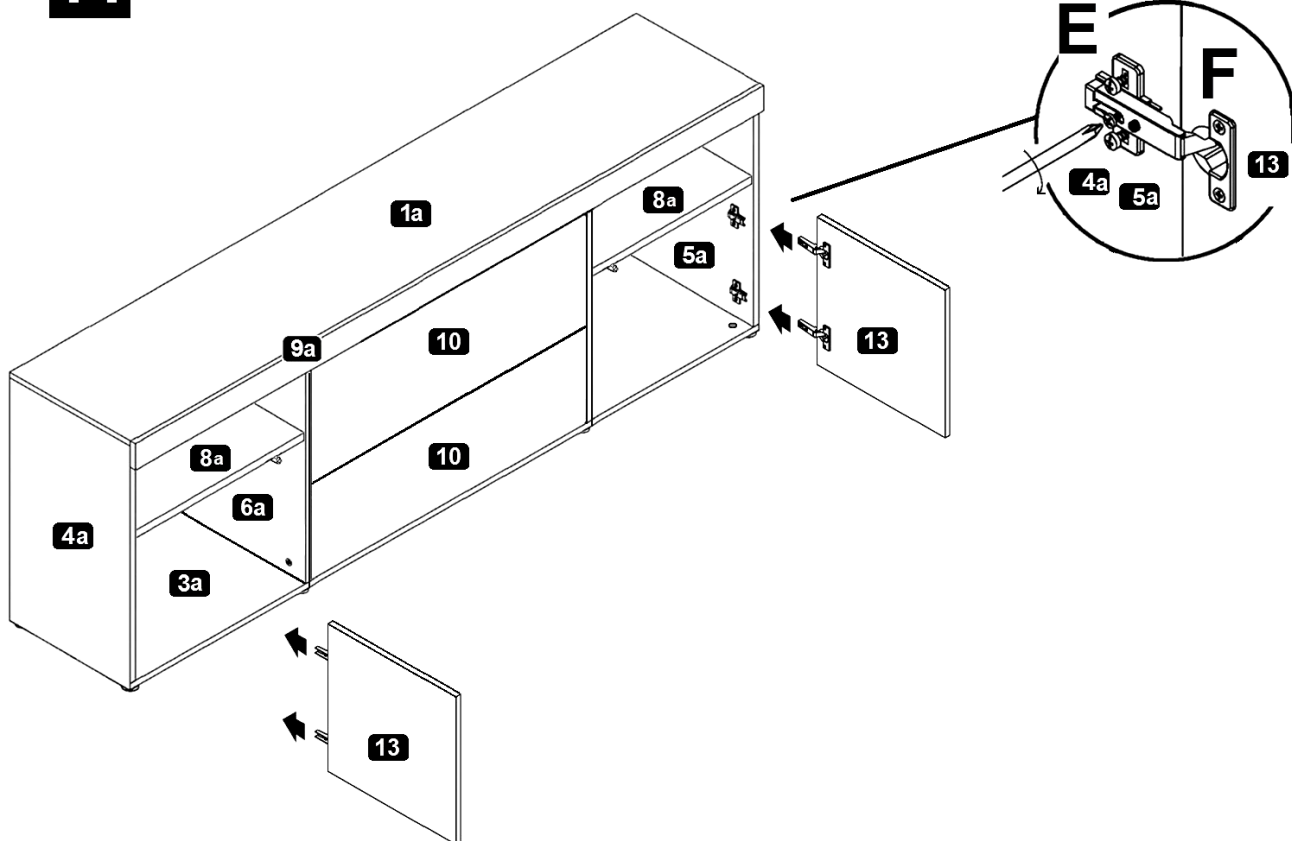

- (D) Push-To-Open einstellen
- (GB) Adjusting the Push-To-Open
- (FR) Régler les Push-To-Open
- (IT) Sistemare Push-To-Open
- (NL) Push-To-Open instellen
- (PL) Nastawić Push-To-Open
- (CZ) Vyrovnajte Push-To-Open
- (RO) Nastavenie Push-To-Open
- (HU) Állítsa be az Push-To-Open
- (SK) Reglare Push-To-Open
- (TR) Push-To-Open ayarlanması
- (RU) Регулировка Push-To-Open

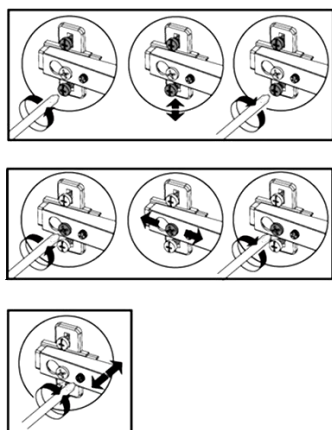
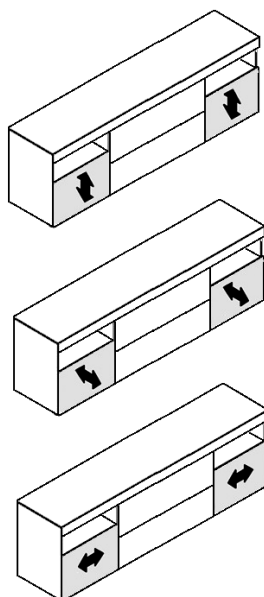
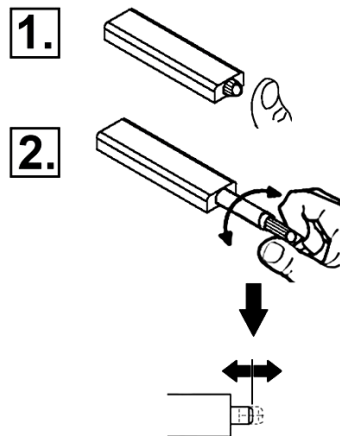

- (D) Türen einstellen (Scharniere justieren)
- (GB) Adjusting the doors (adjusting the hinges)
- (FR) Régler les portes (ajuster les charnières)
- (IT) Sistemare le porte (regolare le cerniere)
- (NL) Deuren instellen (scharnieren afstellen)

- (PL) Nastawić drzwi (wyregulować zawiasy)
- (CZ) Vyrovnajte dvířka (seřid'te závěsy)
- (RO) Nastavenie dverí (nastavenie závesov)
- (HU) Állítsa be az ajtókat (állítsa be a zsanérokat)
- (TR) Reglare uşi (ajustare balamale)
- (SK) Kapíárov avarlanması (menteşelerin seviye ayarı)
- (RU) Регулировка дверей (регулировка шарнира)