

Art. Nr. 403900
1/7

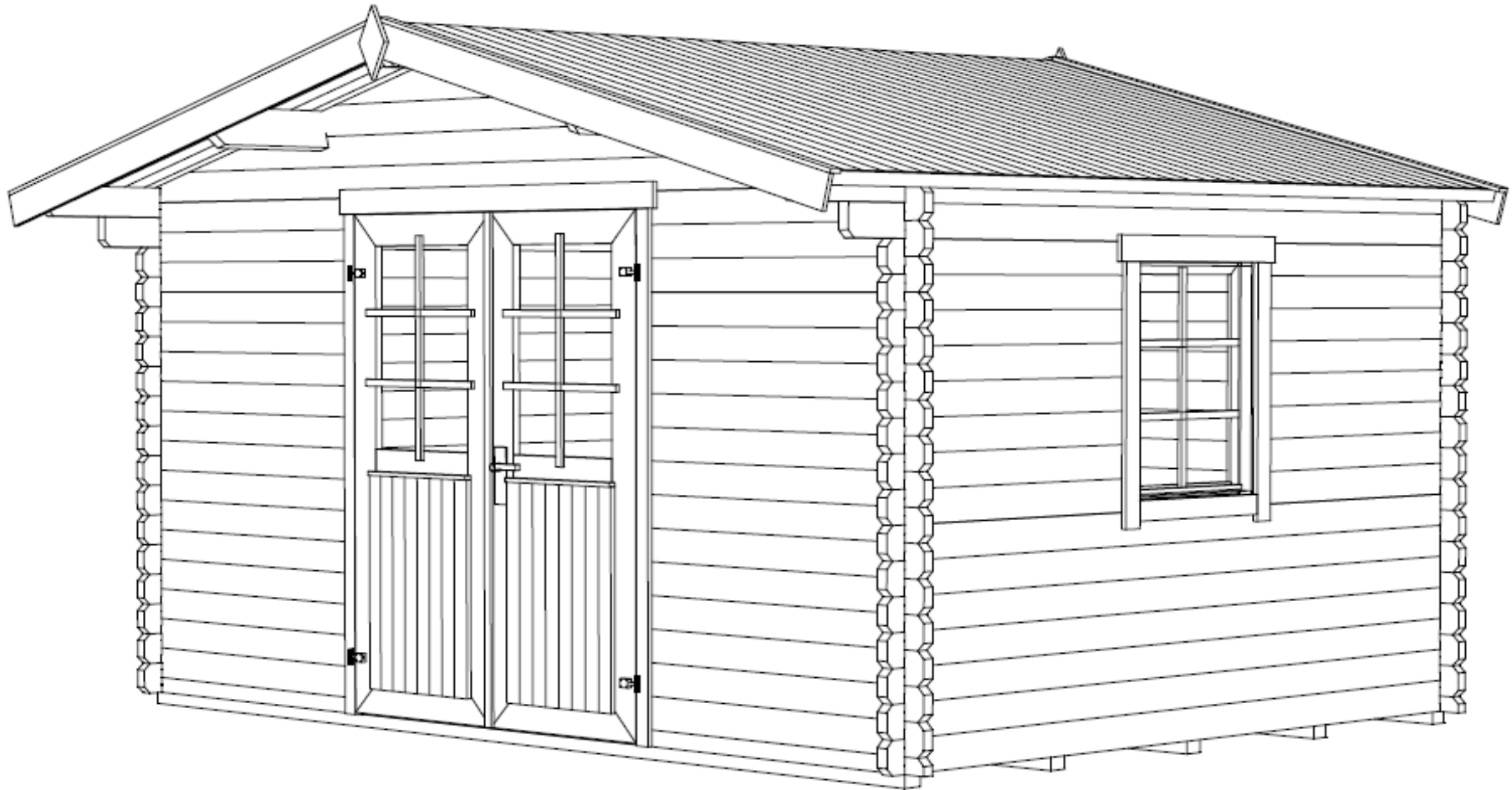

3.08.2016

Art.Nr. 403900

GROUNDPLAN - GRUNDPLAN - PLAN DE MASSE

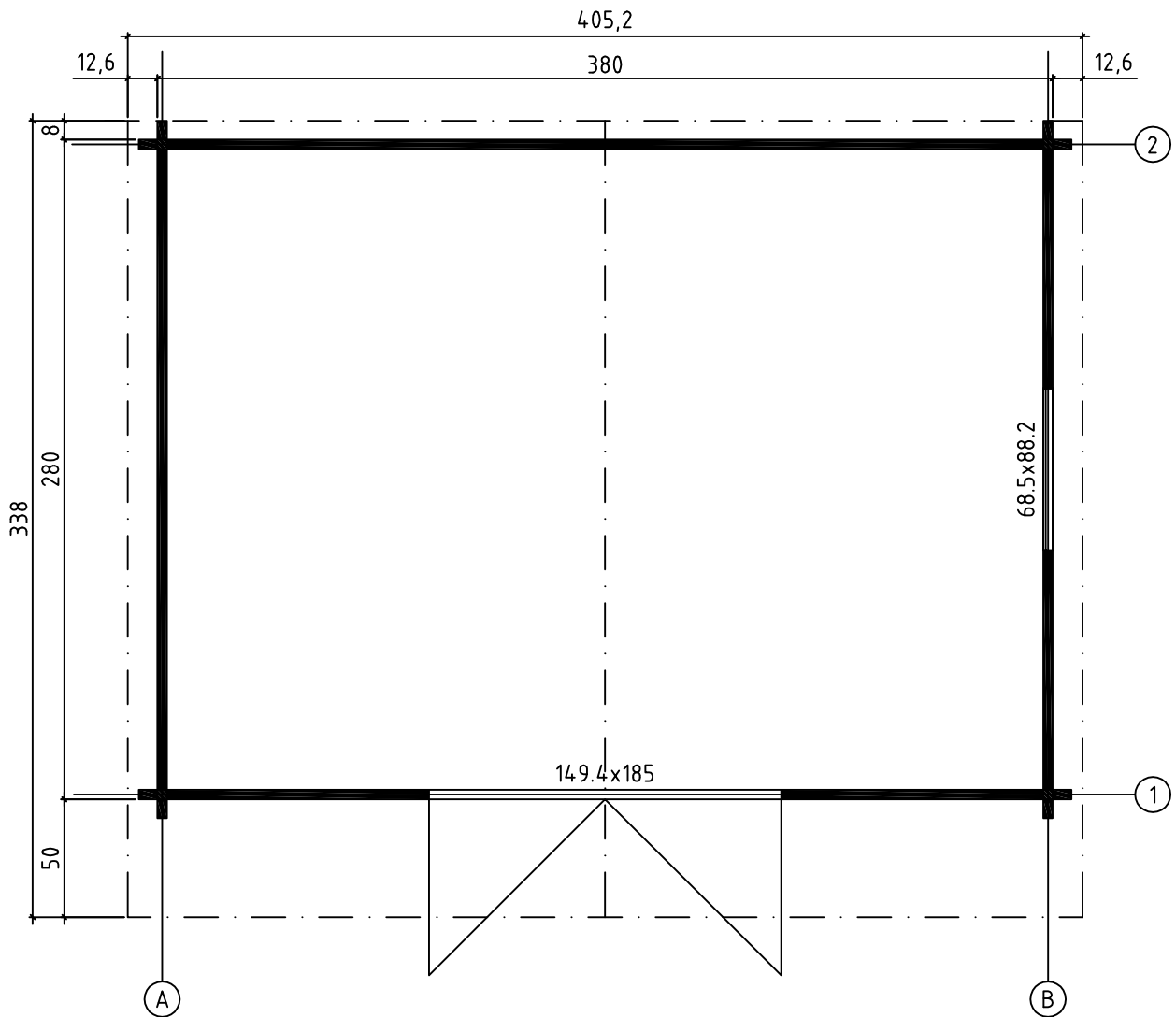

Art.Nr. 403900

FOUNDATION - FUNDAMENT - FONDATION



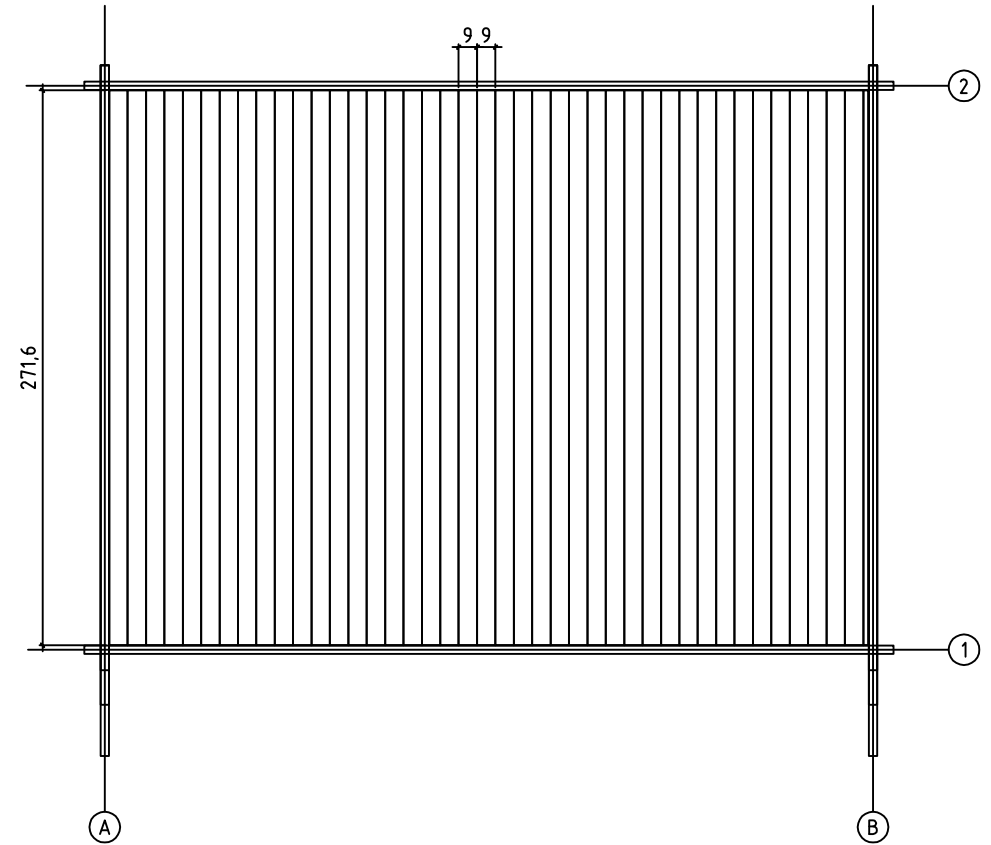
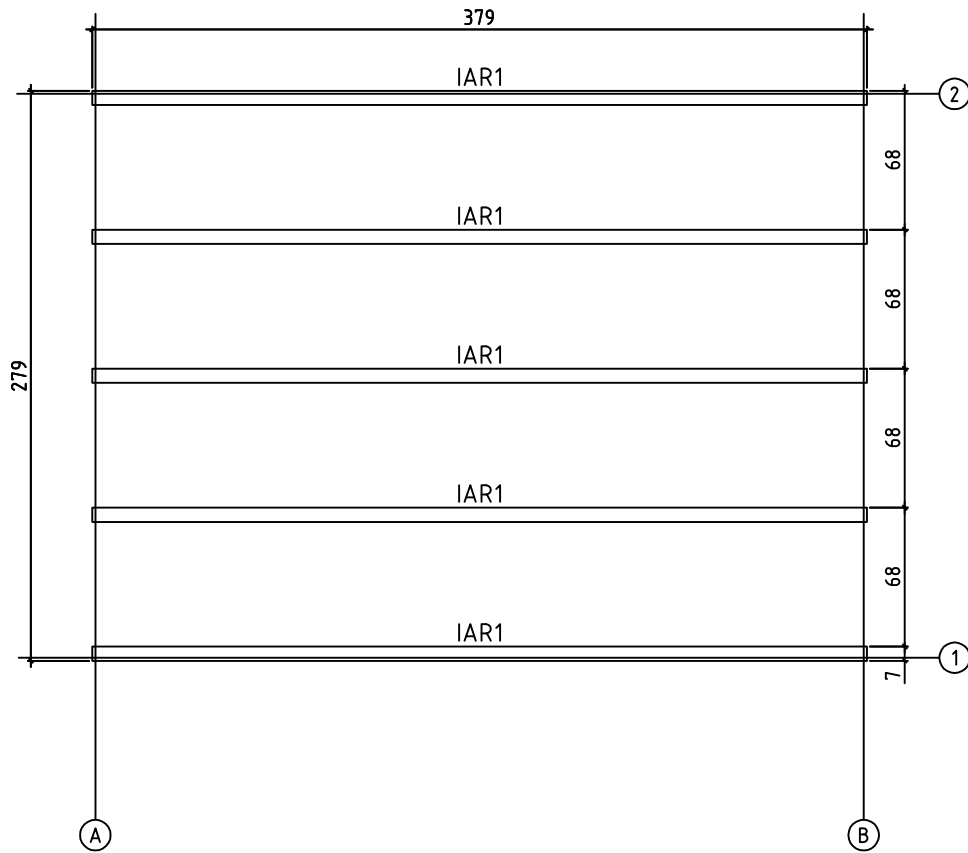



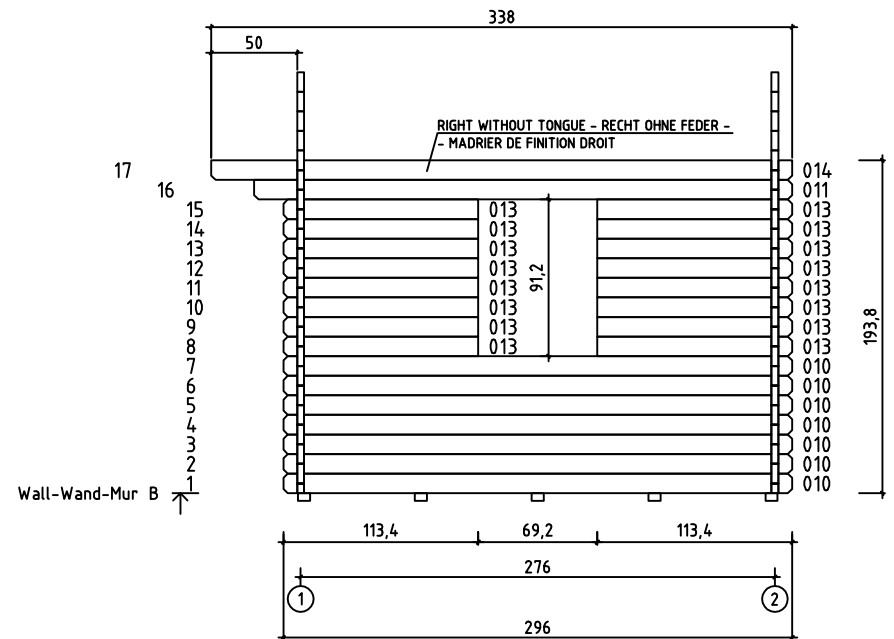
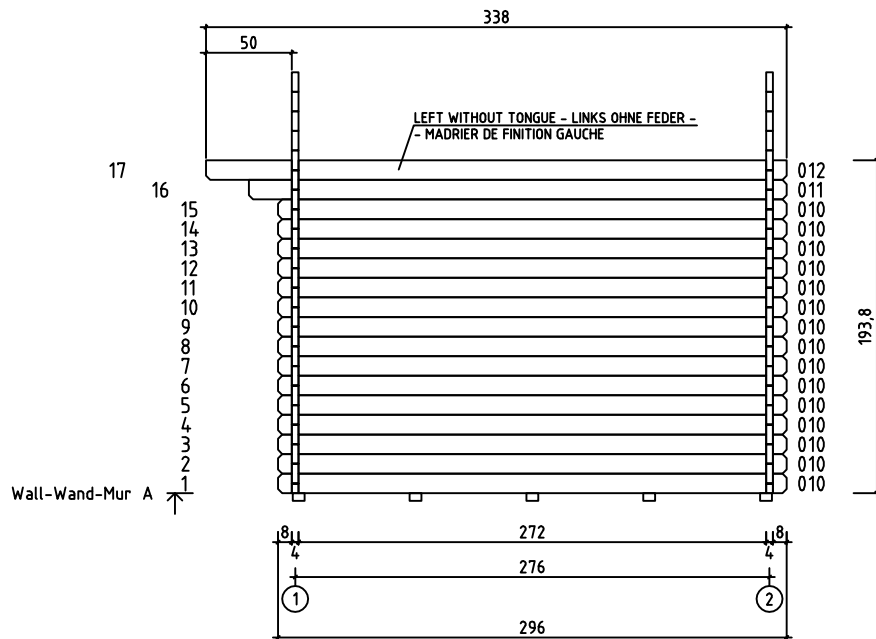
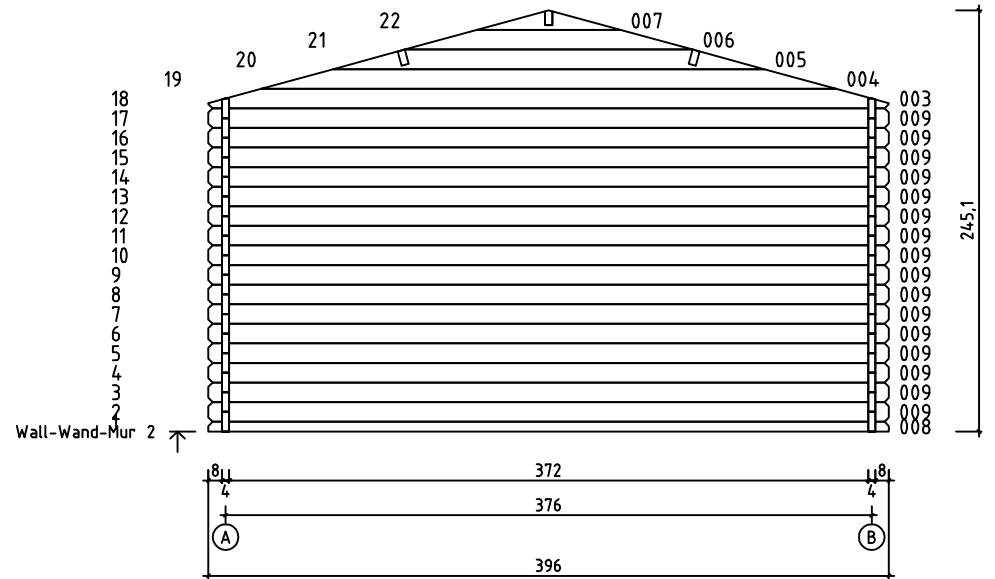
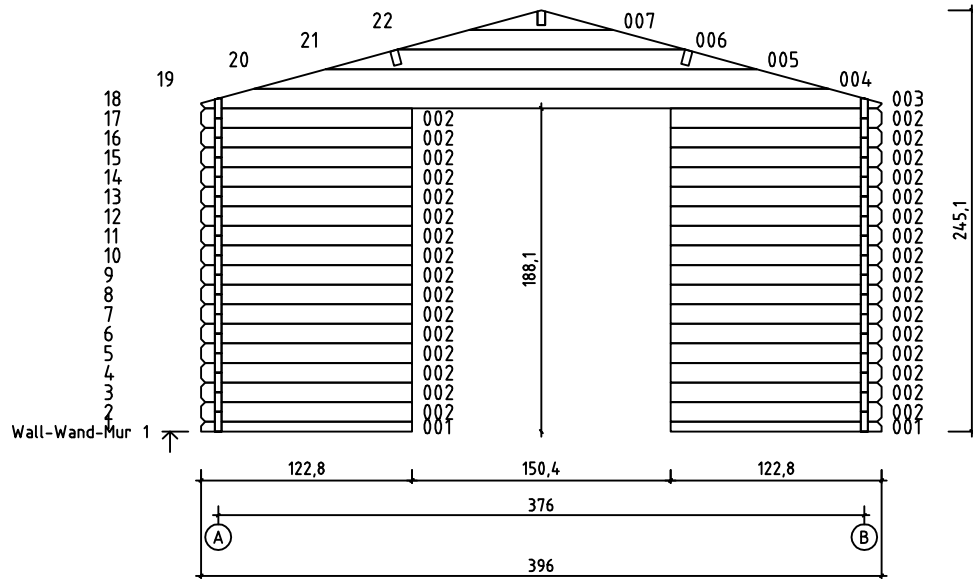



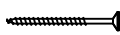
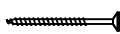
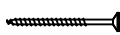
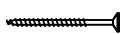



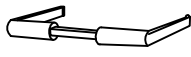

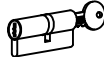
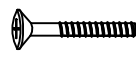
FLOOR BOARDS - FUSSBODENBRETTER - PLAN POSE PLANCHER



Art.Nr. 403900

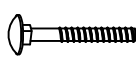

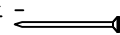
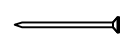
Pos	03.08.2016	Piecelist - Stücklist - Liste des composants Art.Nr. 403900	5/7	Q.	P. (mm)	L. (mm)
001				2	40x57	1228
002				32	40x114	1228
008				1	40x57	3960
009				16	40x114	3960
010				22	40x114	2960
011				2	40x114	3130
012				1	40x120	3380
013				16	40x114	1134
014				1	40x120	3380
W1-1 W2-1				2		
IAR1	FOUNDATION - FUNDAMENT - FONDATION 			5	70x45	3790
PR1	ROOF BEAM - DACHBALKEN - PANNE DE TOIT 			1	44x140	3380
A-PR1	ROOF BEAM - DACHBALKEN - PANNE DE TOIT 			2	44x140	3380
	FLOOR BOARDS - FUSSBODENBRETTER - LAME DE PLANCHER			42	90x18	2716
	ROOF BOARDS - DACHBRETTER - VOLIGES			76	90x15	2100
	FLOOR FILLET - FUSSBODENLEISTE - CORNIERE DE FINITION DU PLANCHER				18x18	12.86
	ROOFING FELT FILLET - DACHPAPPENLEISTE - BAGUETTE DE FIXATION DU FEUTRE BITUMEUX			4	15x45	2150
TB-1	EAVES BOARD - TRAUFBRETT - BANDEAU DE TOIT			2	15x45	3380
KFS-1	STORM PROTECTION - STURMLEISTE - LATTE ANTI-TEMPETE			4	22x45	2050
	GABLE MOULDING - GIEBELLEISTE - - PLANCHE DE RIVE			4	15x120	2150
FS1	WINDOW HANDLE FITTINGS - FENSTERGRIFF - POIGNÉE D'OUVERTURE DE FENETRE			1		
NF2	ZN NAIL FOR FLOOR FILLET - ZN NÄGEL FÜR FUSSBODENLEISTE - - POINTE POUR CORNIERE DE FINITION DU PLANCHER			26	1.4x40	
HS8	SCREW FOR GABLE SEGMENT - SCHRAUBEN FÜR DECKBLATT - - VIS POUR FIXATION LOSANGE DE FINITION			4	3.5x35	
HS1	SCREW FOR GEORGIAN BARS - SCHRAUBE FÜR SPROSSEN - VIS DE BARRES GEORGIANNE			18	2.5x20	

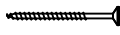
Pos	03.08.2016	Piecelist - Stücklist - Liste des composants Art.Nr. 403900	6/7	Q.	P. (mm)	L. (mm)
HS59		SCREW FOR DOORSTEP - SCHRAUBEN FÜR SWELLE - VIS DE FIXATION DU SEUIL DE PORTE		3	3x30	
HS4		SCREW FOR FILLET - SCHRAUBE ZUR BEFESTIGUNG TÜRLEISTE - - VIS D'ASSEMBLAGE DU CADRE DE PORTE		5	3x30	
HS11		SCREW FOR DOOR HINGES - SCHRAUBE FÜR TÜRRIEGEL - - VIS POUR CHARNIERE DE PORTE		16	4x30	
HS12		SCREW FOR DOOR HINGES - SCHRAUBE FÜR TÜRRIEGEL - - VIS POUR CHARNIERE DE PORTE		12	4x40	
HS13		SCREW FOR DOOR JAMB - SCHRAUBE FÜR TÜRRAHMEN - VIS DE FIXATION POUR MONTANT DE PORTE		2	4x60	
HS18		SCREW FOR ROOF BEAMS - SCHRAUBEN FÜR DACHBALKEN - - VIS POUR PANNE DE TOIT		10	5x120	
HS16		SCREW FOR 1. WALL BEAM - SCHRAUBE FÜR 1. BOHLENREIHE - - VIS DE FIXATION DES FONDATIONS		7	5x90	
HS16		SCREW FOR DOOR JAMB - SCHRAUBE FÜR TÜRRAHMEN - VIS DE FIXATION POUR MONTANT DE PORTE		2	5x90	
SH40		HAMMER BLOCK - SCHLAGHOLZ - CALLE DE FRAPPE 40mm		1		
TL4		DOOR HANDLE FITTINGS - TÜRGRIFF - GARNITURE DE POIGNÉE DE PORTE		1		
TL5		DOOR HANDLE FITTINGS - TÜRGRIFF - SET DE GARNITURES DE SERRURE DE PORTE		1		
		CYLINDER - ZYLINDERSCHLOSS - CYLINDRE DE SERRURE		1	30x30	
FSP		BOLT FOR WINDOW HANDLE FITTINGS - BOLZEN FÜR FENSTERGRIFF BESCHLAG - BOULON POUR POIGNÉE D'OUVERTURE DE FENETRE		2		
HS9		SCREW FOR GABLE MOULDING - SCHRAUBEN FÜR GIEBELLEISTE - - VIS DE FIXATION POUR PLANCHE DE RIVE		24	3.5x50	
HS12		SCREW FOR EAVES BOARDS - SCHRAUBEN FÜR TRAUFBRETT - - VIS DE FIXATION POUR BANDEAU DE TOIT		16	4x40	
TL		LATCH BOLT FÜR DOUBLE DOOR - TORRIEGEL - LOQUET POUR DOUBLE PORTE		1	90 mm	
GS		GABLE SEGMENT - DECKBLATT - LOSANGE DE FINITION		2		
SFS		NUT FOR STORM PROTECTION - SCHRAUBENMUTTER FÜR STURMLEISTE - - ÉCROU POUR LAME ANTI-TEMPETE		8	D6	
BFS		BOLT FOR STORM PROTECTION - BOLZEN FÜR STURMLEISTE - - VIS POUR LAME ANTI-TEMPETE		8	6x70	
DFS		WASHER FOR STORM PROTECTION - DICHTSCHEIBE FÜR STURMLEISTE - - RONDELLE POUR LAME ANTI-TEMPETE		8	D6	
NF5		ZN NAIL FOR ROOFING FELT FILLET - ZN NÄGEL FÜR DACHPAPPENLEISTE - - POINTE POUR BAGUETTE FIXATION FEUTRE BITUMEUX		20	2x40	
NF4		ZN NAIL FOR ROOF - ZN NÄGEL FÜR DACHBRETT - POINTE POUR TOIT		242	2x50	
NF4		ZN NAIL FOR FLOOR - ZN NÄGEL FÜR FUSSBODENBRETT - CLOUS POUR PLANCHER		215	2x50	
		MALE BOLT HINGE FOR DOOR - TÜRRIEGEL - PARTIE MALE DE CHARNIERE DE PORTE		4	DIN15-57	
HS9		SCREW FOR FIXING DOOR TO THE WALL - SCHRAUBE ZUR BEFESTIGUNG TÜR - ZARGE MIT WAND - VIS DE FIXATION PARTIE BASSE DORMANTS DE PORTE AU 1ER RANG DE MADRIER		2	3.5x50	

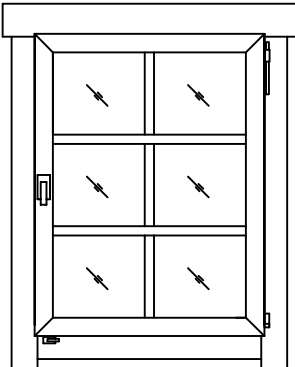
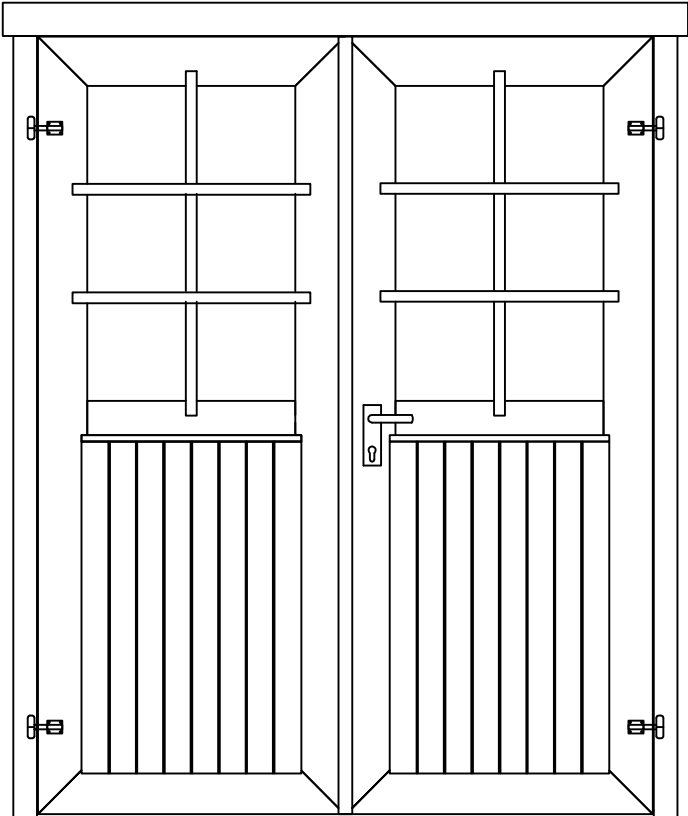
Pos	03.08.2016 Piecelist - Stücklist - Liste des composants Art.Nr. 403900	7/7	Q.	P. (mm)	L. (mm)
	<p data-bbox="229 197 758 226">WINDOW - FENSTER - FENETRE 685x882 SGC</p> <p data-bbox="1023 197 1190 226">AK.1.106.SSP.d</p> 	1			
	<p data-bbox="245 907 724 936">DOOR - TÜR - PORTE 1494x1850 SGA+28</p> <p data-bbox="954 907 1193 936">TUK.2.056.SVP.MX40</p> 	1			

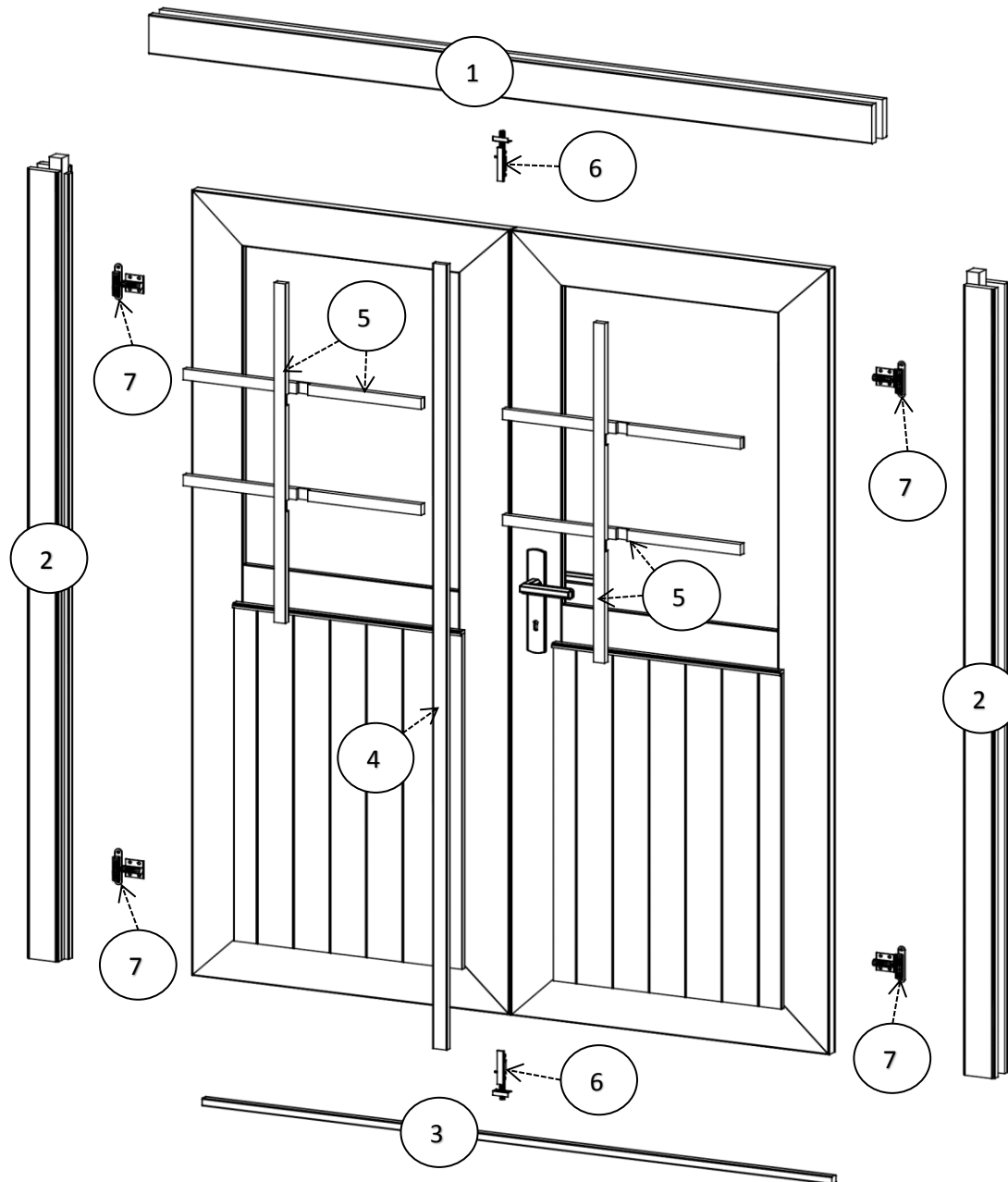

Allgemeine Montageanleitung - General assembly instructions - Instructions générales de montage

Pos	Piece list - Stückliste - Liste des pièces	Q.	P (mm)
1		1	77x100
2		2	77x80
3		1	18x29
4		1	13x32
5		6	15x25
6		2	
7		4	

Metall Tüschwelle gehört nicht zum Lieferumfang - Metal sill cover not included - Seuil de porte en métal non-inclus

