

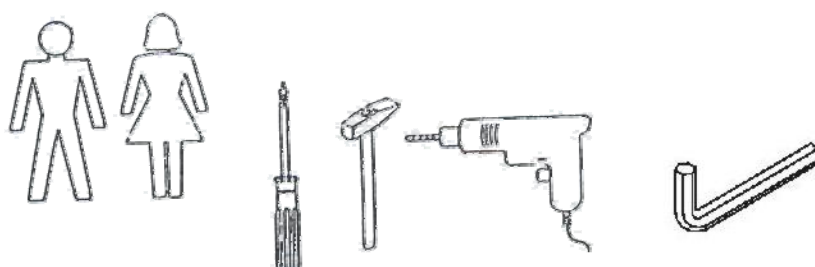

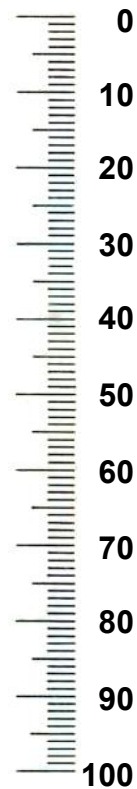

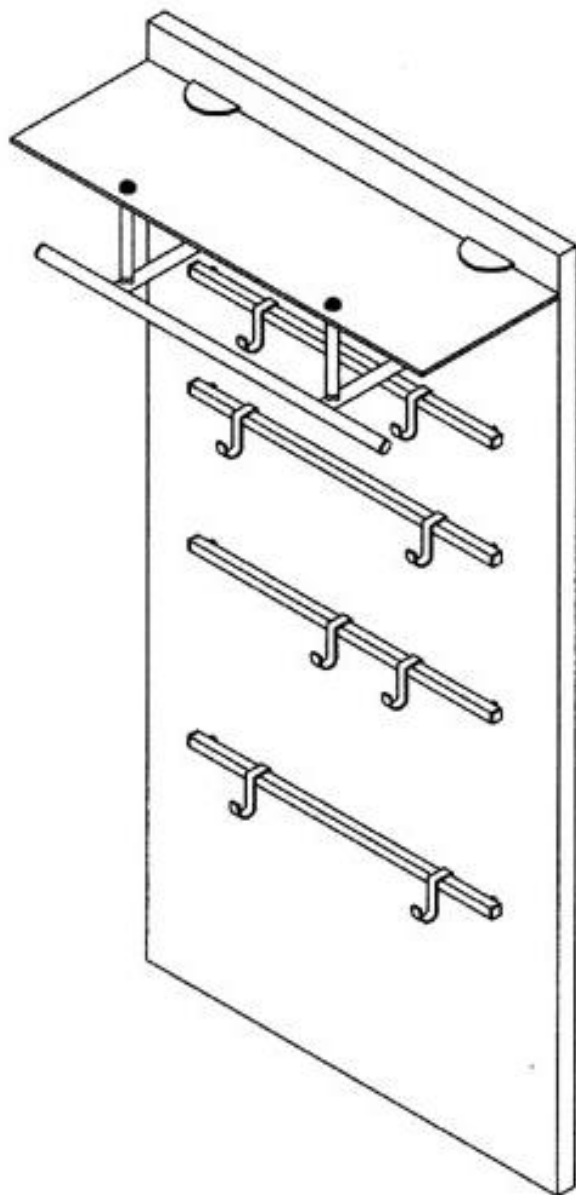

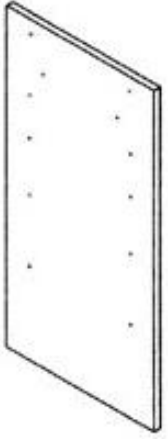















Typ: Nr. 1200



 1-1x	 2-1x	 3-4x	 4-1x	 5-2x	 6-2x	 A-8x	
	 B-2x 6x32mm	 C-4x 6x25mm	 D-4x 4x12mm	 E-8x 4x25mm	 F-2x 4x10mm	 G-4x 8x8mm	 H-2x
	 I-2x	 J-8x	 K-8x	 L-4x	 M-2x	 N-8x	 O-4x
					 P-4x	 Q-4x	

1

2

3

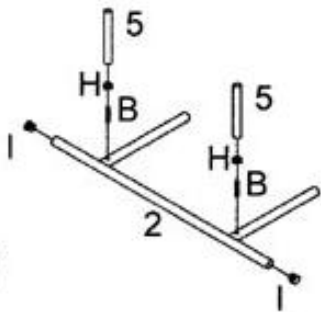

4

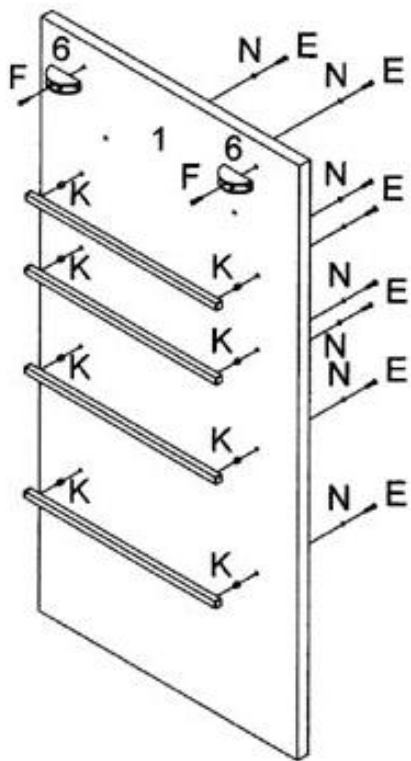
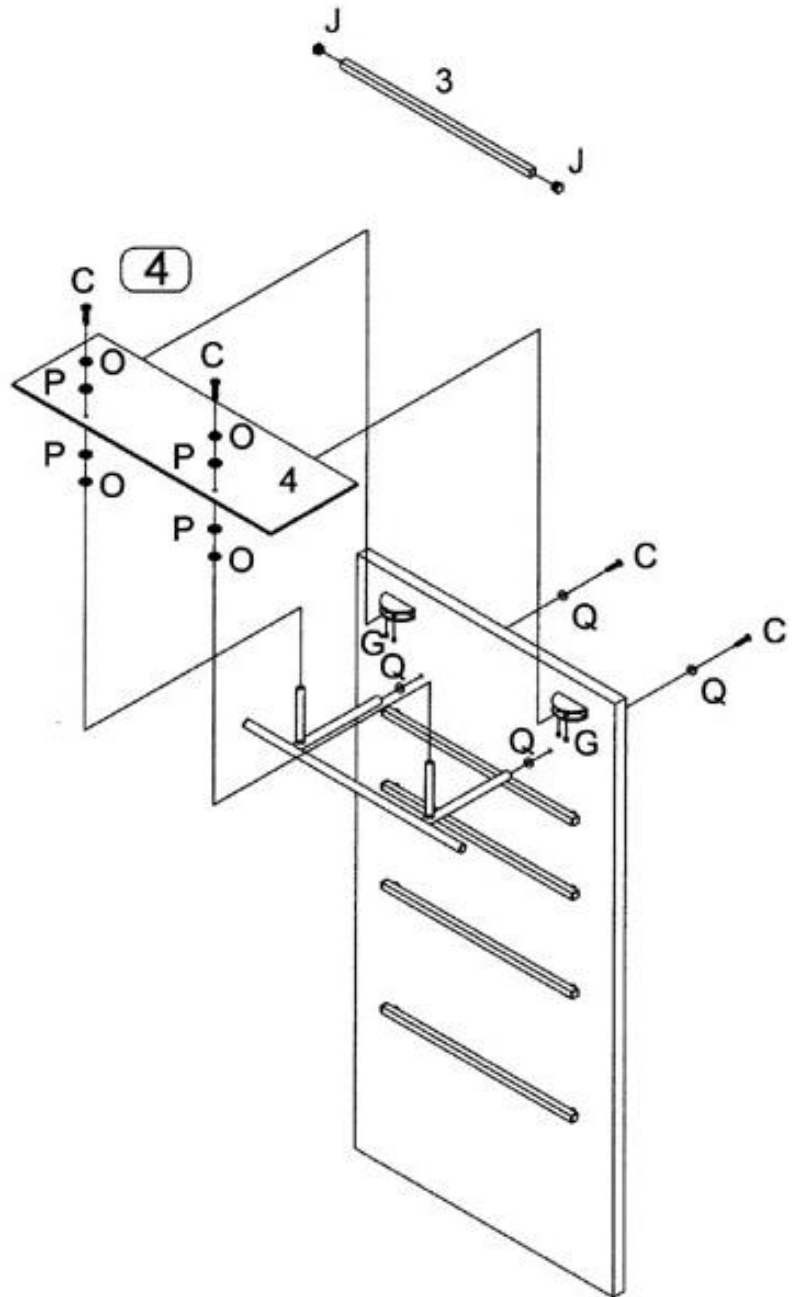

5

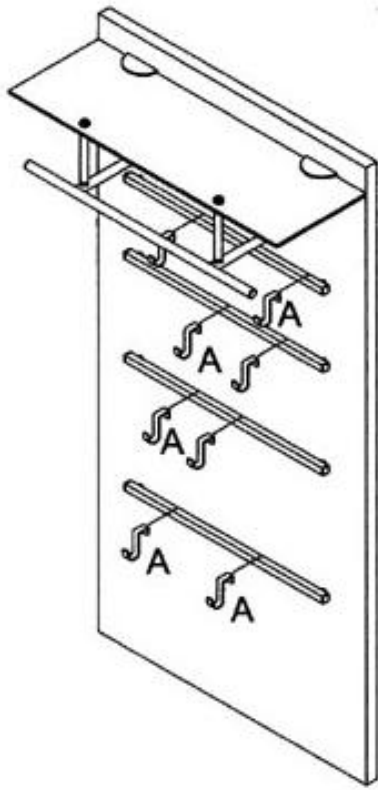

6

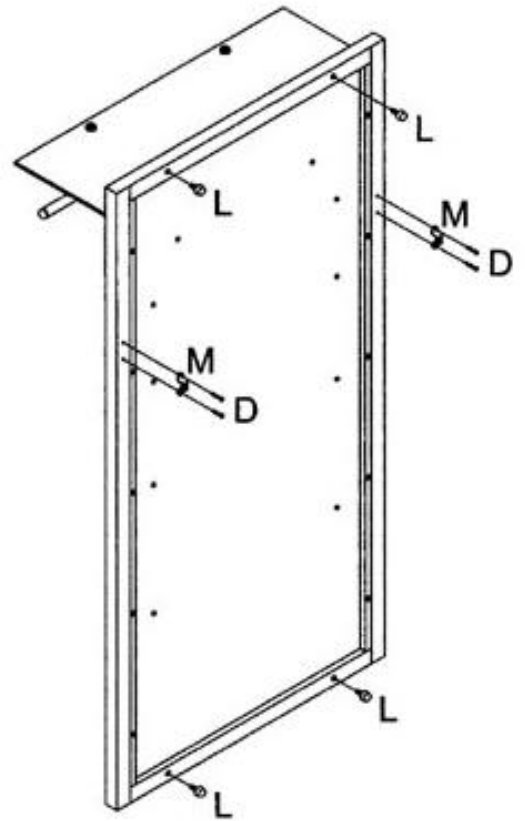

7

