

Assembly Instruction / Montageanleitung

WF324455+WF324456

Sideboard

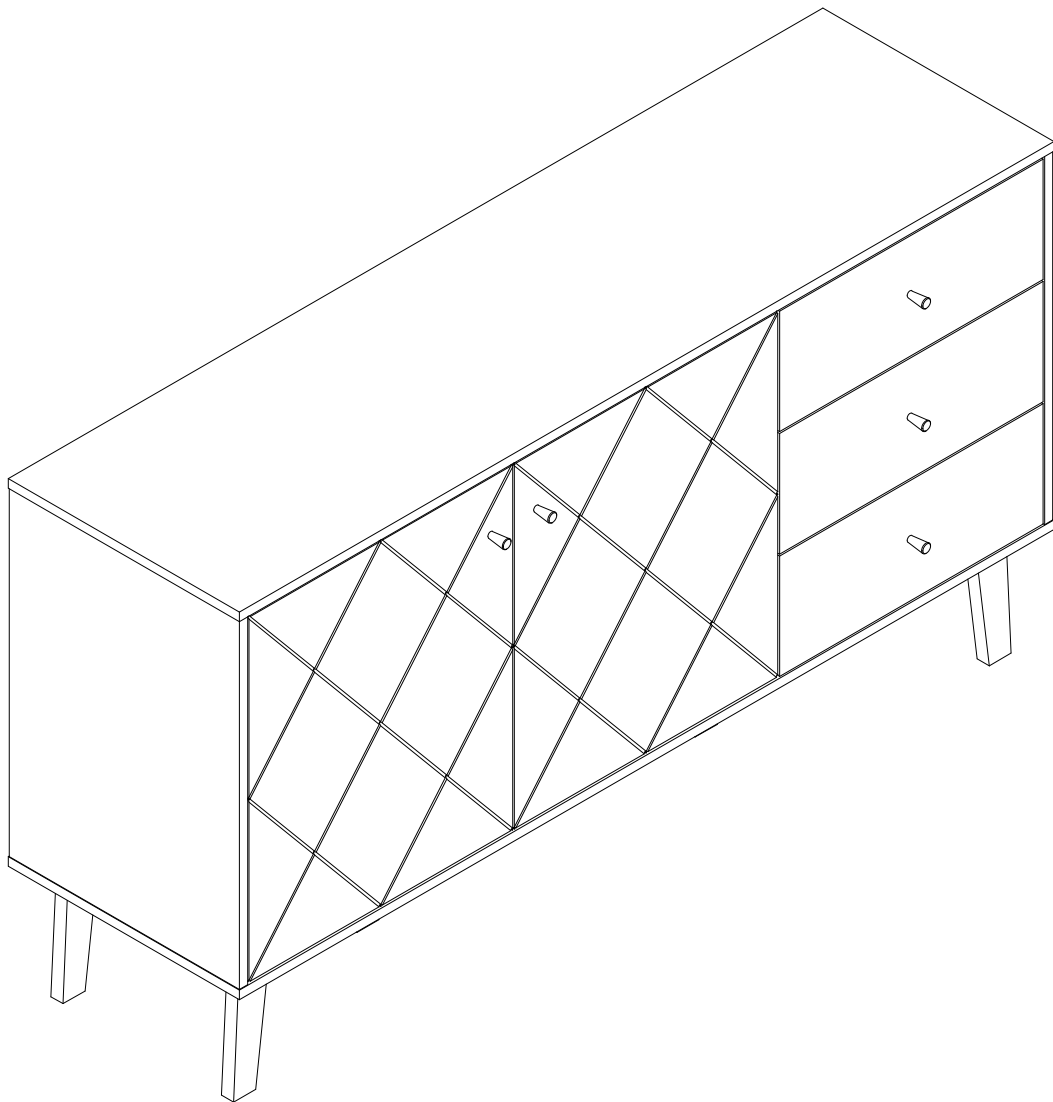

Our product will be delivered to you in 2 packages. The delivery times of these 2 packages may differ, please be patient and thank you for your understanding. Please read these instructions fully before starting assembly:

Tools required: Phillips screwdriver (medium & large)

1. Check you have all the components and tools listed on the following pages.
2. Remove all fittings from the plastic bags and separate them into their groups.
3. Keep children and animals away from the work area, small parts could choke if swallowed.
4. Make sure you have enough space to layout the parts before starting.
5. During assembly do not stand or put weight on the product, this could cause damage.
6. Assemble the item as close to its final position (in the same room) as possible.
7. Assemble on a soft level surface to avoid damaging the unit or your floor.
8. Parts of the assembly will be easier with 2 people.
9. To reduce the likelihood of damaging your product please ensure that your power drill is set on a low torque setting.
10. Assemble all parts and bolts loosely during assembly, only once the product is complete should you fully tighten the bolts.
11. Regularly check and ensure that all bolts and fittings are tightened properly.
12. Please do not place items that exceed the load capacity.

Care and maintenance:

Only clean using a damp cloth and mild detergent, do not use bleach or abrasive cleaners.

Unser Produkt wird Ihnen in 2 Paketen geliefert. Die Lieferzeiten dieser 2 Pakete können abweichen, bitte haben Sie etwas Geduld und vielen Dank für Ihr Verständnis. Bitte lesen Sie diese Anweisungen vollständig durch, bevor Sie mit der Montage beginnen: Erforderliches Werkzeug: Kreuzschlitzschraubendreher (mittel und groß)

1. Überprüfen Sie, ob alle auf den folgenden Seiten aufgeführten Komponenten und Werkzeuge vorhanden sind.

2. Entfernen Sie alle Zubehörteile aus den Plastiktüten und teilen Sie sie in ihre Gruppen auf.

3. Halten Sie Kinder und Tiere vom Arbeitsbereich fern, es besteht Erstickungsgefahr durch Kleinteile wenn verschluckt.

4. Stellen Sie sicher, dass Sie genügend Platz zum Anordnen der Teile haben, bevor Sie beginnen.

5. Stellen Sie sich während der Montage nicht auf das Produkt und belasten Sie es nicht, da dies zu Schäden führen kann.

6. Bauen Sie den Artikel so nah wie möglich an seiner endgültigen Position (im selben Raum) zusammen.

7. Stellen Sie das Gerät auf eine weiche, ebene Oberfläche, um eine Beschädigung des Geräts oder Ihres Bodens zu vermeiden.

8. Teile der Montage lassen sich einfacher mit 2 Personen durchführen.

9. Um die Wahrscheinlichkeit einer Beschädigung Ihres Produkts zu verringern, stellen Sie bitte sicher, dass Ihre Bohrmaschine auf ein niedriges Drehmoment eingestellt ist.

10. Setzen Sie alle Teile und Schrauben während der Montage locker zusammen. Erst wenn das Produkt fertig ist, sollten Sie die Schrauben vollständig festziehen.

11. Überprüfen Sie regelmäßig und stellen Sie sicher, dass alle Schrauben und Anschlüsse ordnungsgemäß festgezogen sind.

12. Bitte platzieren Sie keine Gegenstände, die die Tragfähigkeit überschreiten.

Pflege und Wartung:

Reinigen Sie es nur mit einem feuchten Tuch und einem milden Reinigungsmittel.

Verwenden Sie keine Bleichmittel oder Scheuermittel.

Assembly Instruction / Montageanleitung

ITEM:WF324455&WF324456

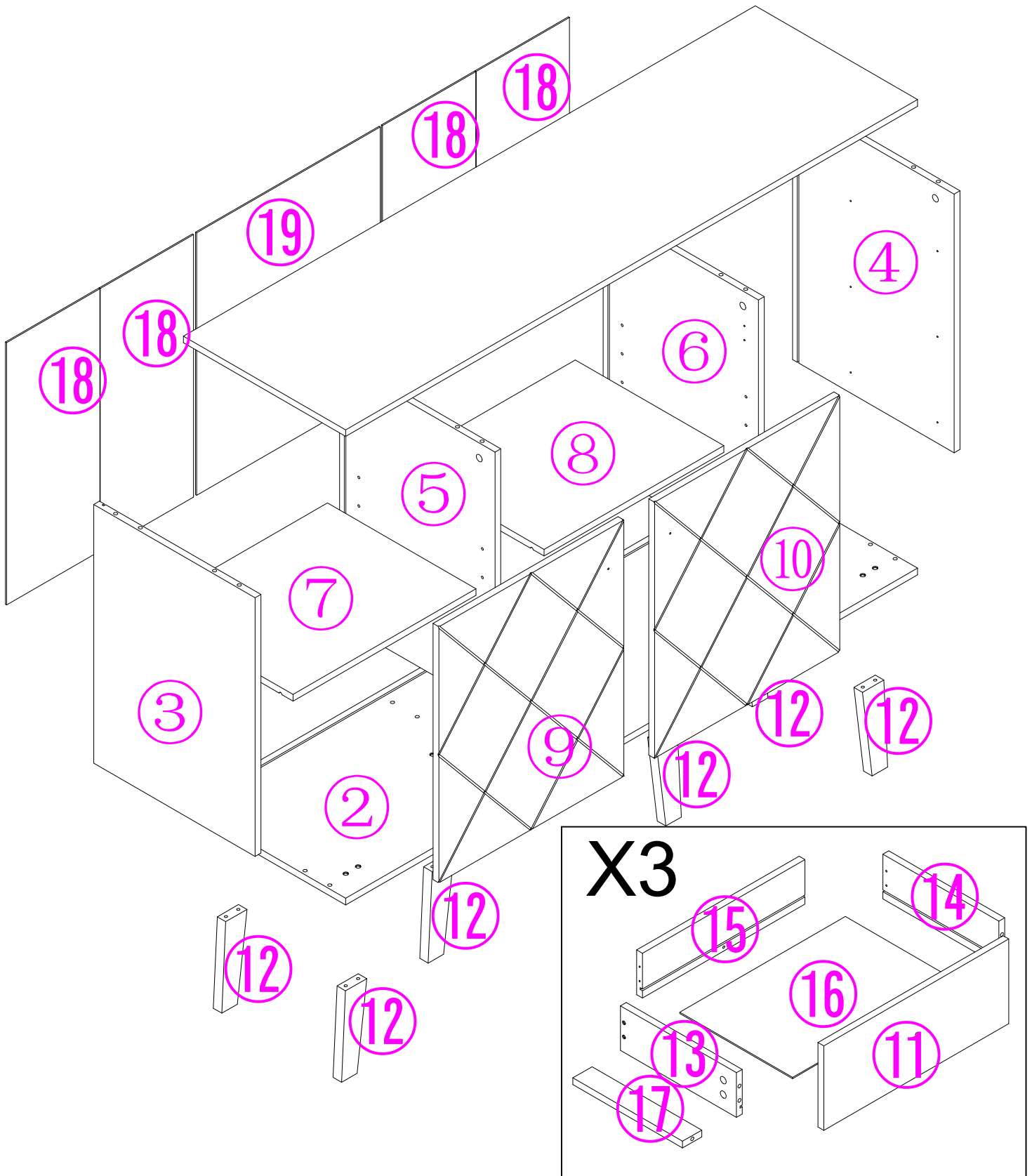

Part List / Stückliste

Please check you have all the panels listed below

/Bitte überprüfen Sie, ob alle unten aufgeführten Panels vorhanden sind

Note: The quantities below are the correct amount to complete the assembly. In some cases more fittings may be supplied than are required. / Hinweis: Die unten angegebenen Mengen sind die richtigen Mengen, um die Montage abzuschließen. In manchen Fällen können mehr Armaturen geliefert werden, als erforderlich sind.

WF324455

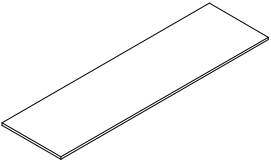
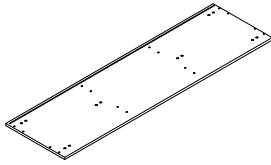
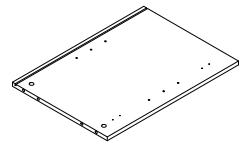
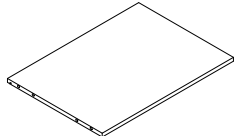
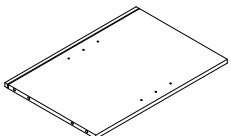
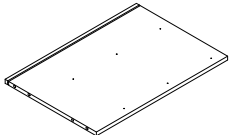
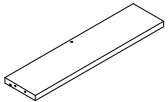
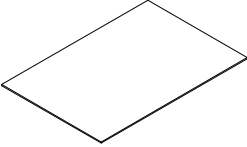
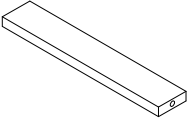
<p>① X 1</p>  <p>Top panel</p>	<p>② X 1</p>  <p>Bottom panel</p>	<p>③ X 1</p>  <p>Left side panel</p>
<p>④ X 1</p>  <p>Right side panel</p>	<p>⑤ X 1</p>  <p>Left Middle panel</p>	<p>⑥ X 1</p>  <p>Right Middle panel</p>
<p>⑮ X 3</p>  <p>Drawer back panel</p>	<p>⑯ X 3</p>  <p>Drawer bottom panel</p>	<p>⑰ X 1</p>  <p>Drawer load-bearing panel</p>

Part List / Stückliste

Please check you have all the panels listed below

/Bitte überprüfen Sie, ob alle unten aufgeführten Panels vorhanden sind

Note: The quantities below are the correct amount to complete the assembly. In some cases more fittings may be supplied than are required. / Hinweis: Die unten angegebenen Mengen sind die richtigen Mengen, um die Montage abzuschließen. In manchen Fällen können mehr Armaturen geliefert werden, als erforderlich sind.

WF324456

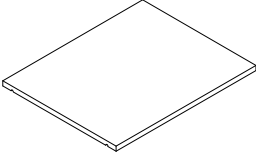
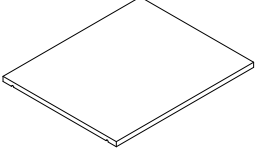
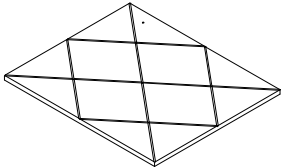
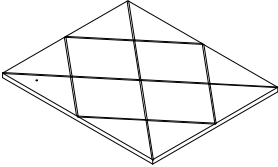
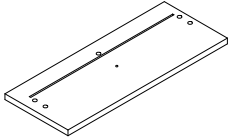
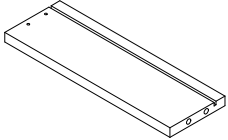
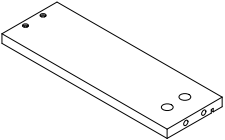
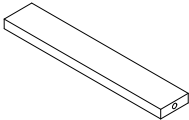
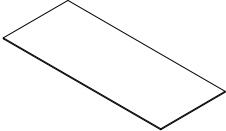
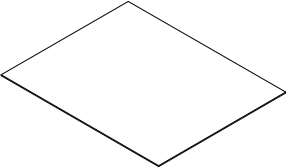
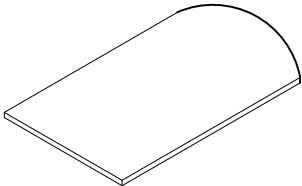
<p>⑦ X 1</p>  <p>Shelf panel</p>	<p>⑧ X 1</p>  <p>Shelf panel</p>	<p>⑨ X 1</p>  <p>Door panel</p>
<p>⑩ X 1</p>  <p>Door panel</p>	<p>⑪ X 3</p>  <p>Drawer surface</p>	<p>⑬ X 3</p>  <p>Drawer side panel</p>
<p>⑭ X 3</p>  <p>Drawer side panel</p>	<p>⑰ X 2</p>  <p>Drawer load-bearing panel</p>	<p>⑱ X 4</p>  <p>Back panel</p>
<p>⑲ X 1</p>  <p>Back panel</p>	 <p>Hardware kit</p>	

Hardware list / Hardwareliste











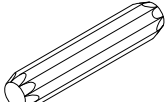
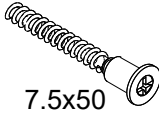
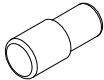
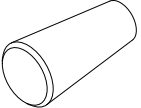
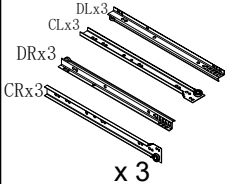

ITEM:WF324455&WF324456

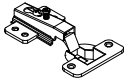
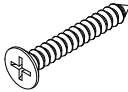
Please check you have all the panels listed below

/Bitte überprüfen Sie, ob alle unten aufgeführten Panels vorhanden sind

Note: The quantities below are the correct amount to complete the assembly. In some cases more fittings may be supplied than are required. / Hinweis: Die unten angegebenen Mengen sind die richtigen Mengen, um die Montage abzuschließen. In manchen Fällen können mehr Armaturen geliefert werden, als erforderlich sind.

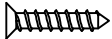
WF324455&WF324456

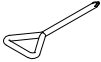
 <p>A1 x 23 eccentric rod</p>	 <p>A2 x 23 eccentric rod gear</p>	 <p>8x40mm B x 16 Dowels</p>	 <p>7.5x50 C x 20 Screws</p>	 <p>D x 8 Shelf support</p>	 <p>E x 5 Handles</p>
 <p>DLx3 CLx3 DRx3 CRx3 x 3 Drawer runner</p>	 <p>4x18 G x 5 Bolts</p>	 <p>H x 2 Hook</p>	 <p>I x 2 Hook</p>	 <p>3.5x35 J x 15 Screws</p>	 <p>3.5x35 K x 68 Screws</p>
 <p>L x 20 panel hook</p>	 <p>N1 x 2 Anti collapse</p>	 <p>N2 x 2 Anti collapse</p>	 <p>3.5x14mm N3 x 2 Screws</p>	 <p>3.5x35mm N4 x 2 Screws</p>	 <p>N5 x 2 Anchor</p>
 <p>M x 2 plastic strip</p>	 <p>P x 1 Tool</p>				

Assembly Instruction / Montageanleitung

ITEM:WF324455&WF324456

Step 1

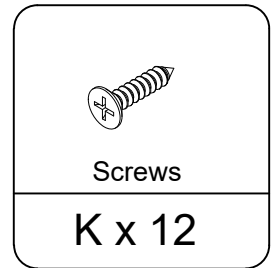
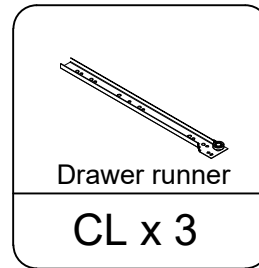
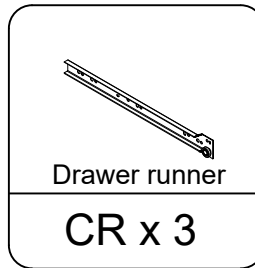
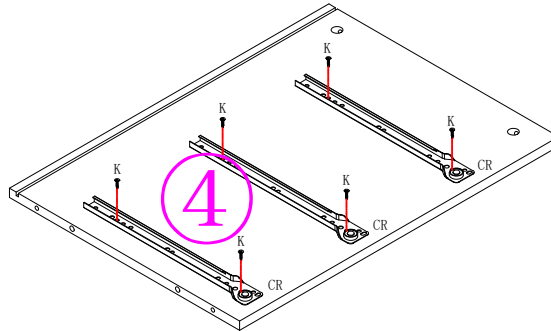
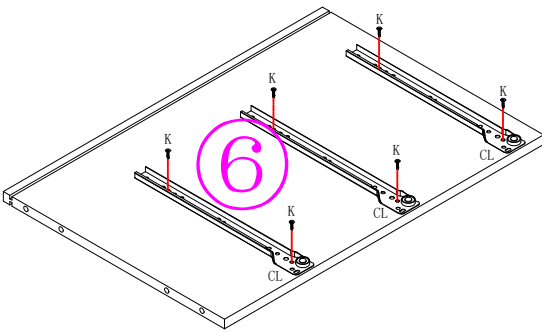
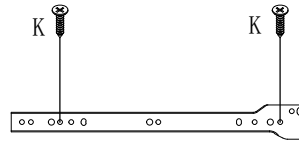

Step 2

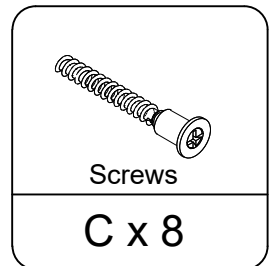
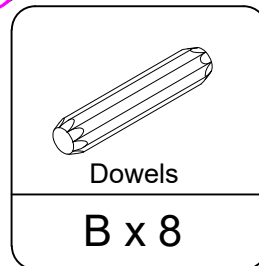
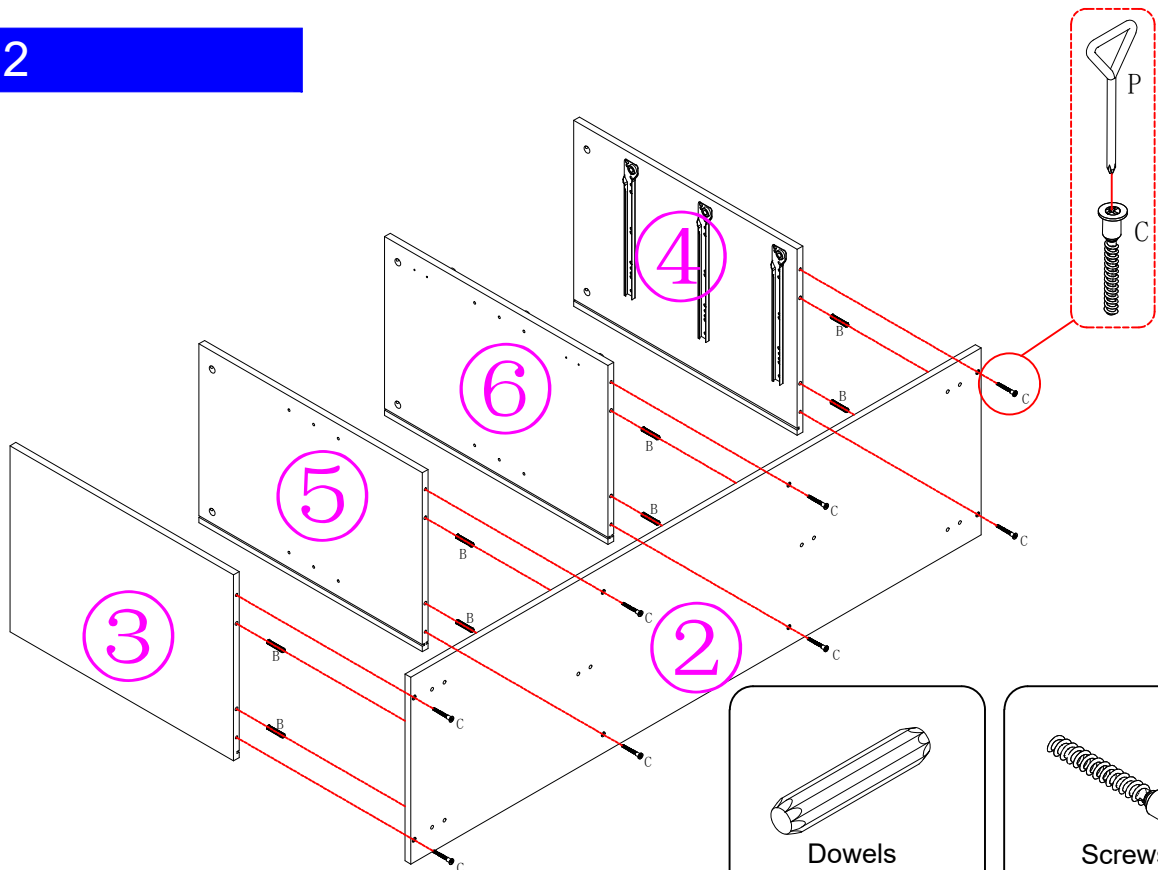

Assembly Instruction / Montageanleitung

ITEM:WF324455&WF324456

Step 3

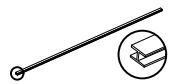
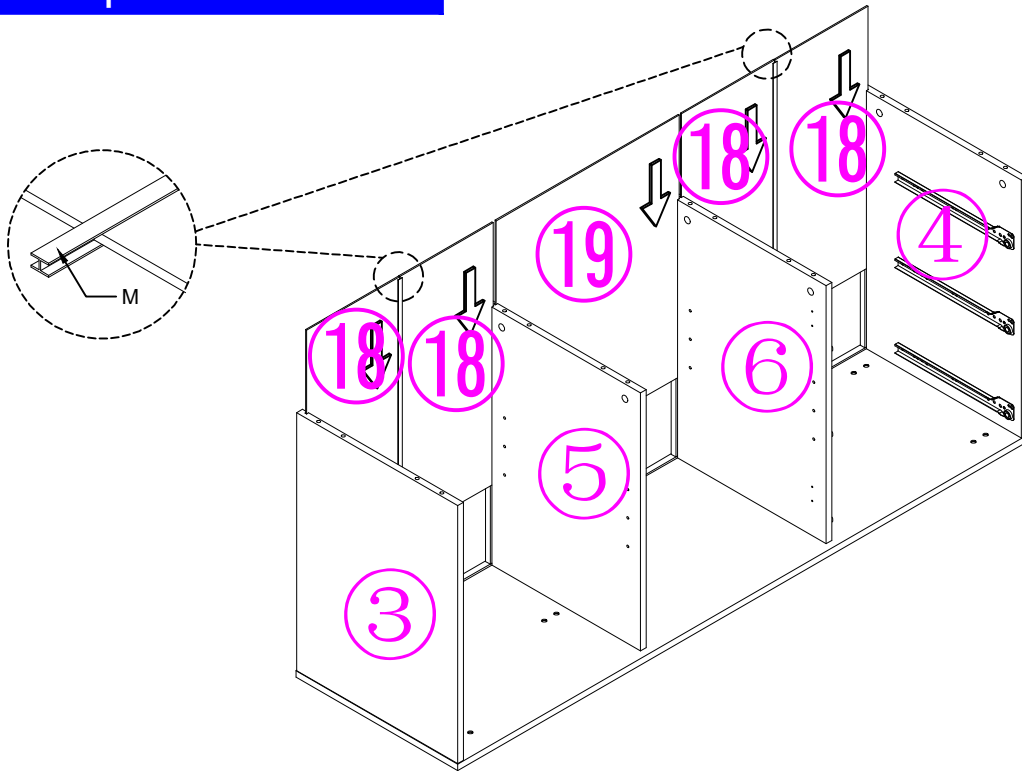

plastic strip

M x 2

Step 4

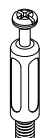
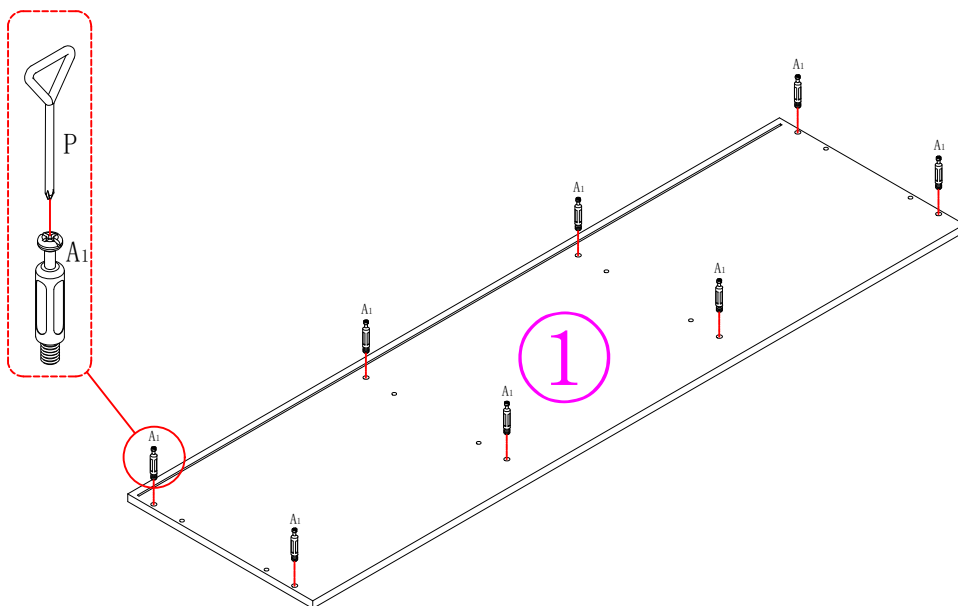

eccentric rod

A1 x 8

Assembly Instruction / Montageanleitung

ITEM:WF324455&WF324456

Step 5

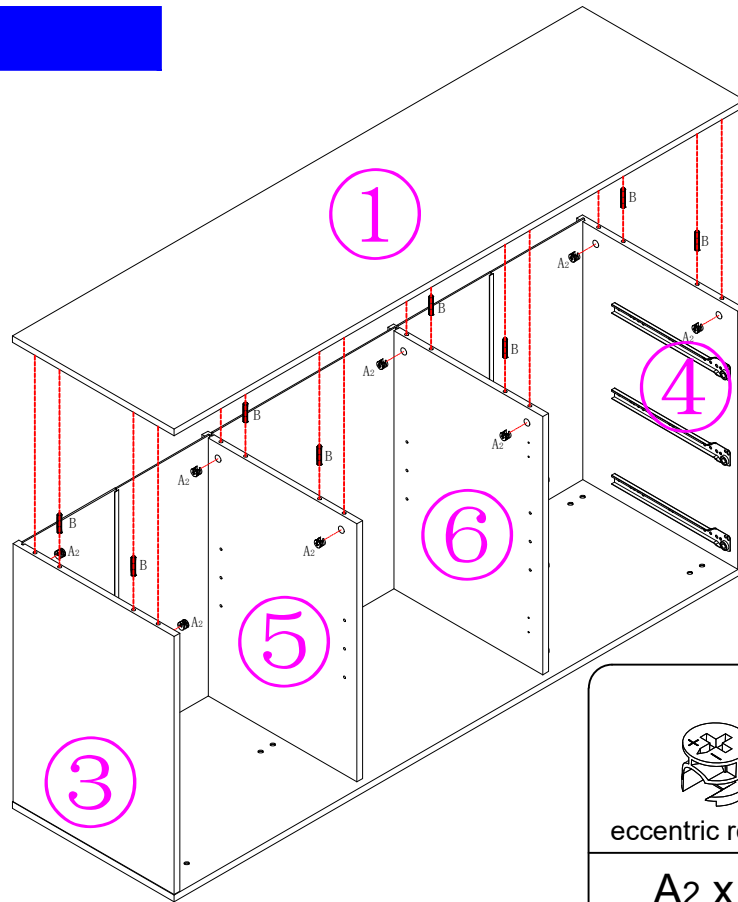

eccentric rod gear

A2 x 8

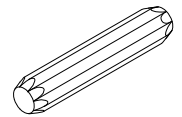

Dowels

B x 8

Step 6

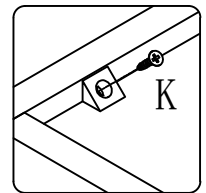
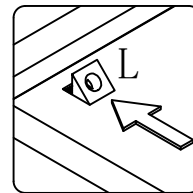
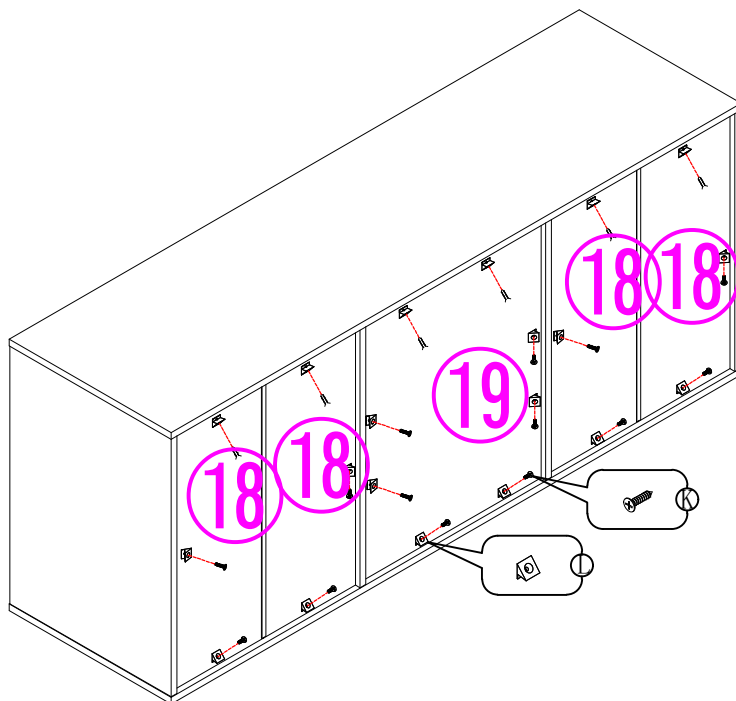

Screws

K x 20



panel hook

L x 20

Assembly Instruction / Montageanleitung

ITEM:WF324455&WF324456

Step 7

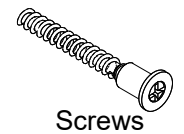
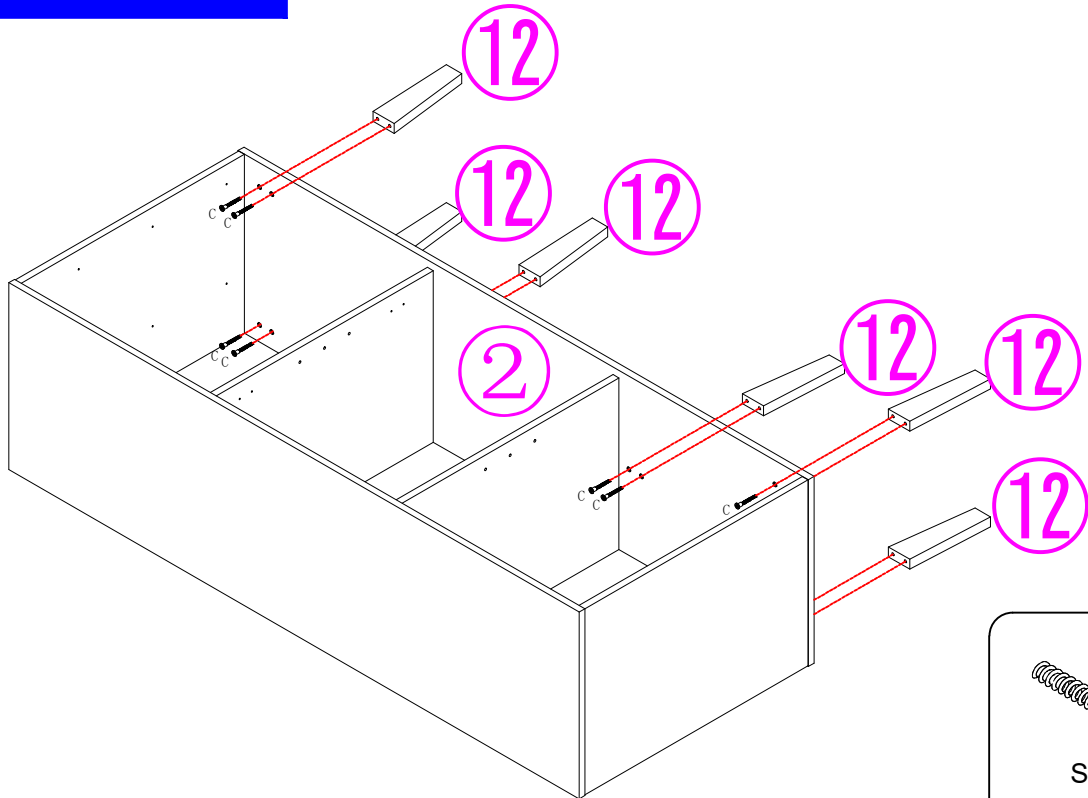

Screws

C x 12

Step 8

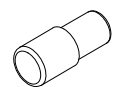
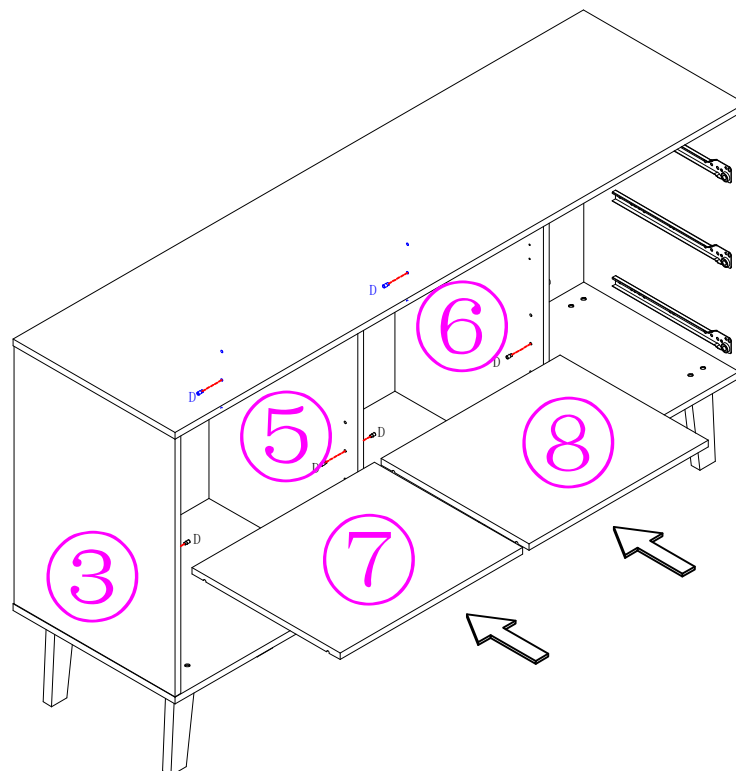

Shelf support

D x 8

Assembly Instruction / Montageanleitung

ITEM:WF324455&WF324456

Step 9

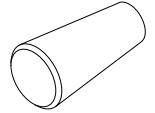
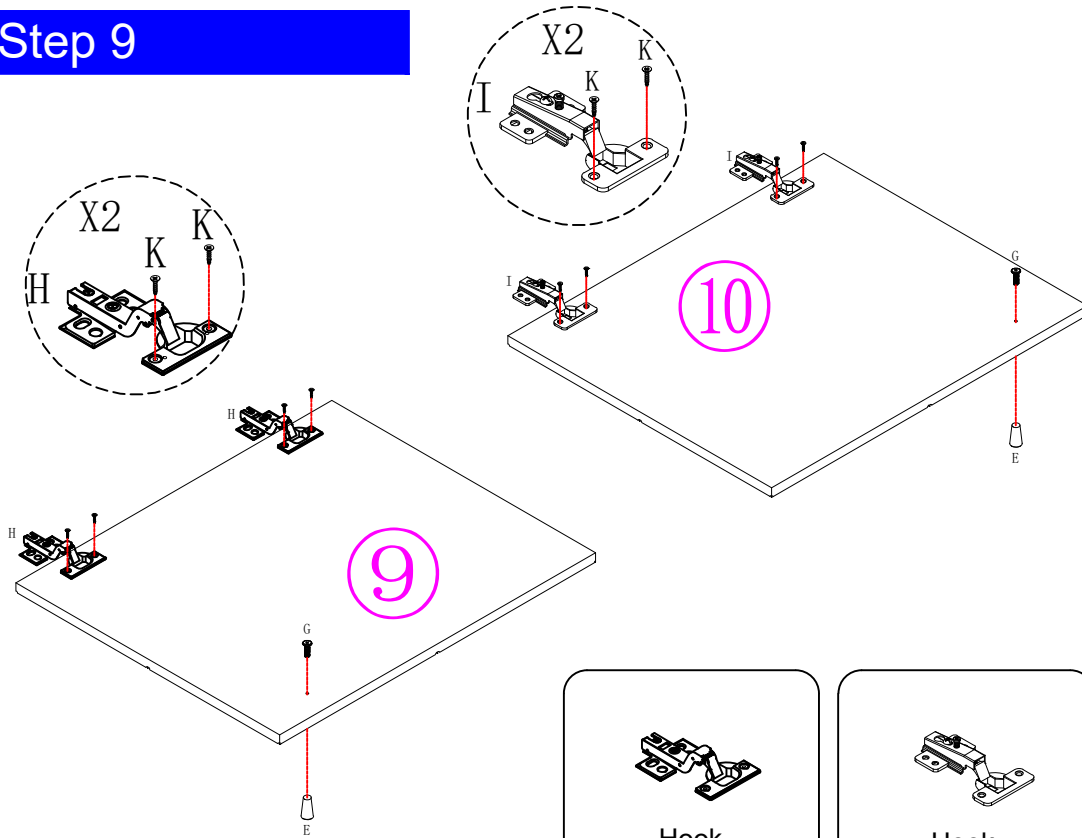

Handles

E x 2



Bolts

G x 2



Hook

H x 2

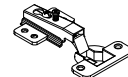

Hook

I x 2

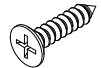

Screws

K x 8

Step 10

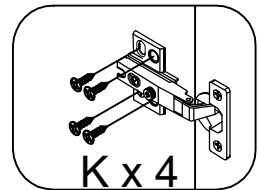
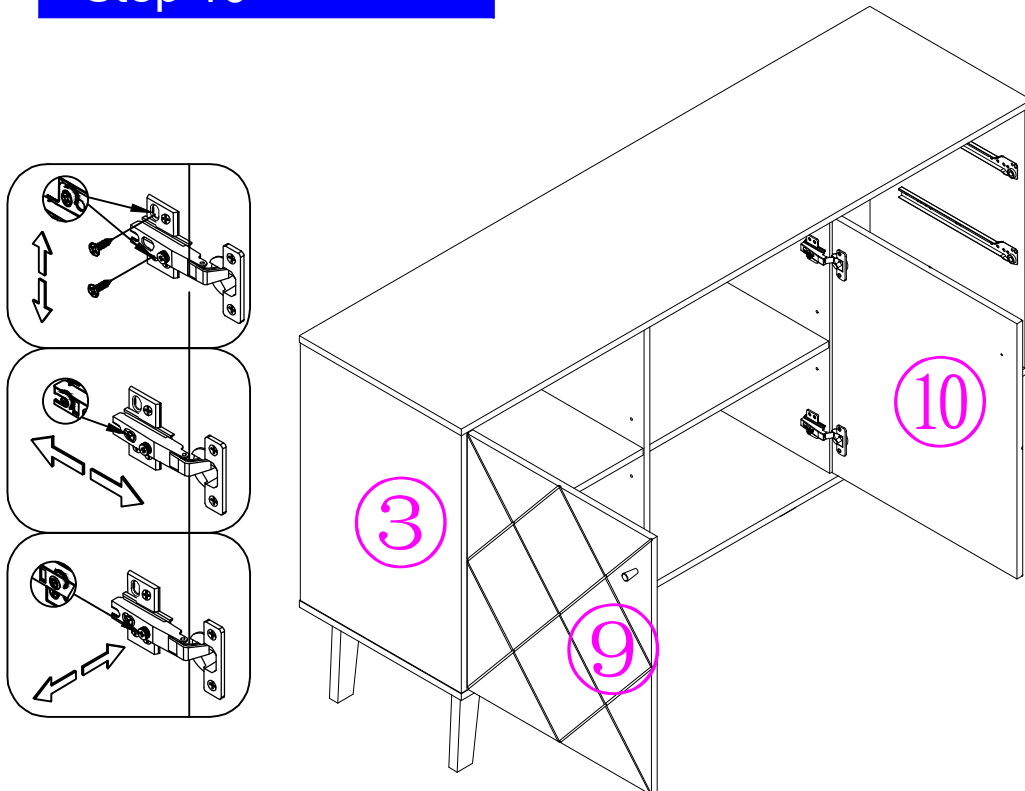

x4

K x 4



Screws

K x 16

Assembly Instruction / Montageanleitung

ITEM:WF324455&WF324456

Step 11

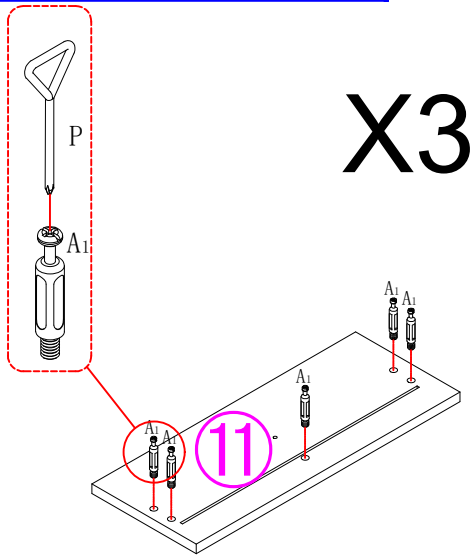

X3

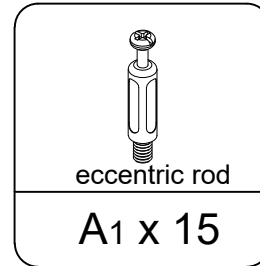
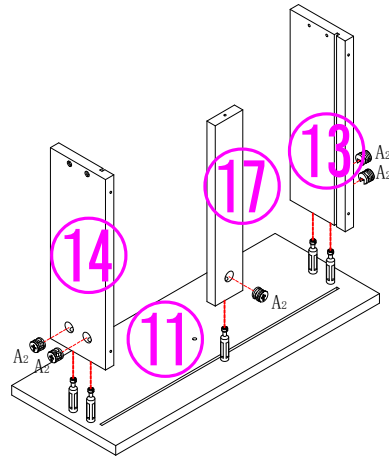

eccentric rod

A1 x 15

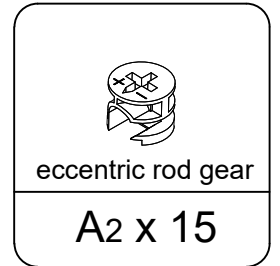

eccentric rod gear

A2 x 15

Step 12

X3

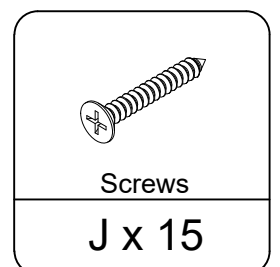
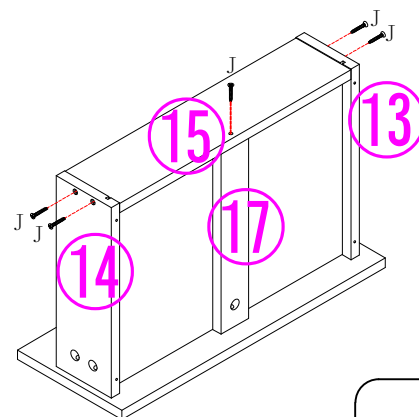
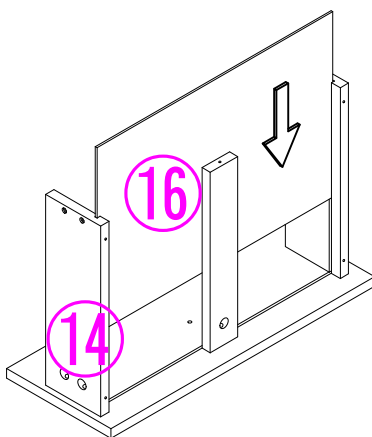

Screws

J x 15

Assembly Instruction / Montageanleitung

ITEM:WF324455&WF324456

Step 13

X3

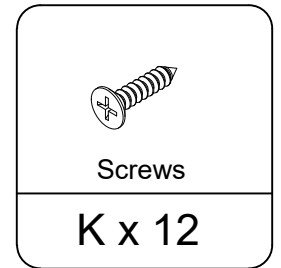
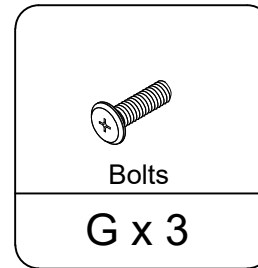
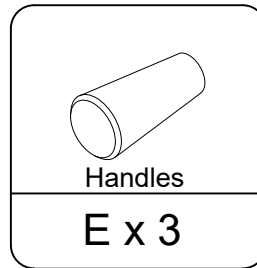
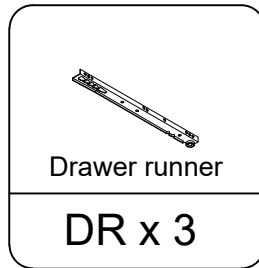
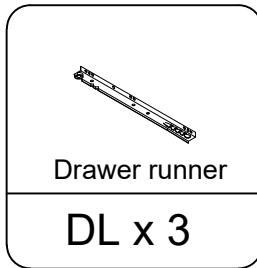
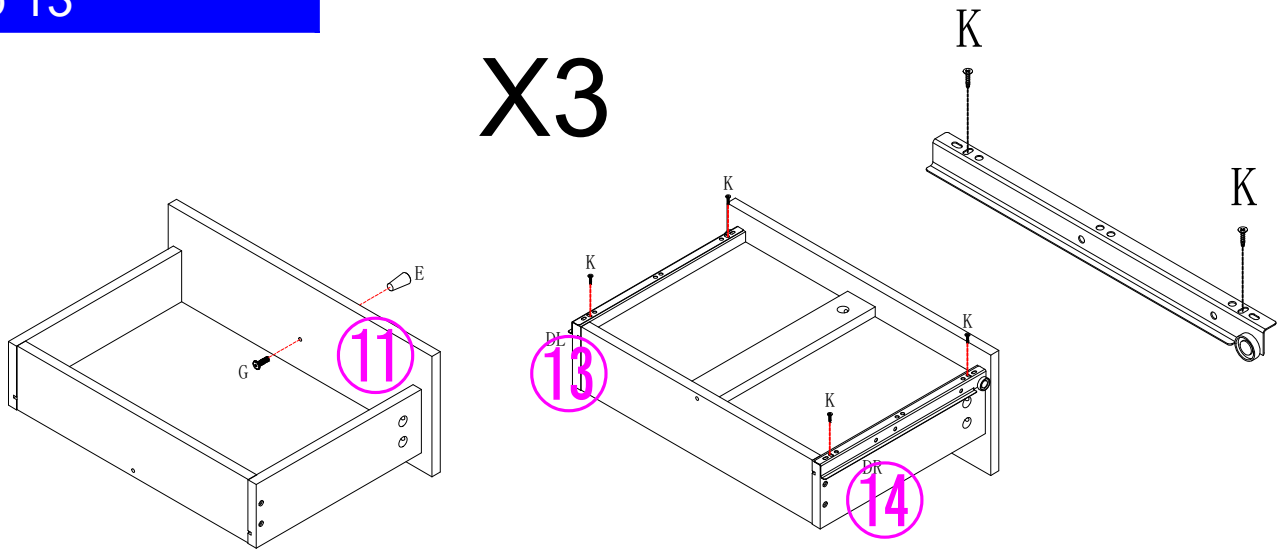

Step 14

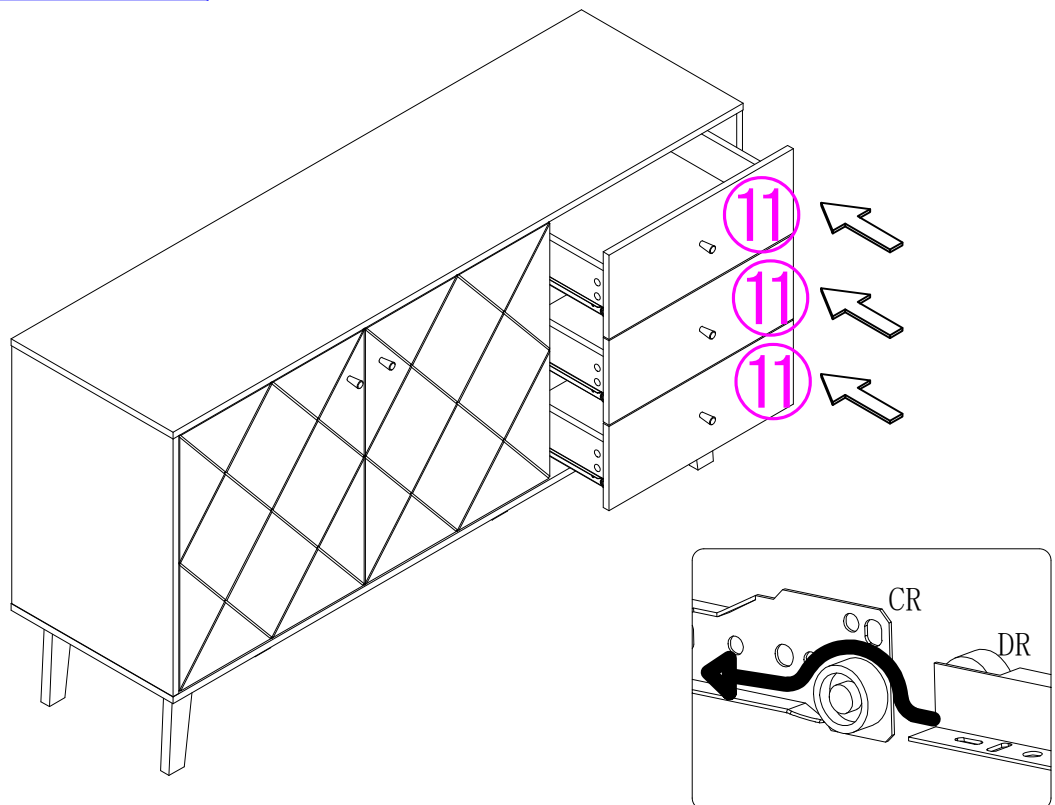

Assembly Instruction / Montageanleitung

ITEM:WF324455&WF324456

Step 15



Warning:
Before drilling, check
wall for hidden pipes
and cables.

The unit is floor
standing, but it is
recommended that the
unit is secured to the
wall.

1. Move the unit into
desired position.
2. Mark the wall with a
suitable scribe the
position of the fixing
holes.
3. Drill holes and insert 2 x
wall plug

