

3

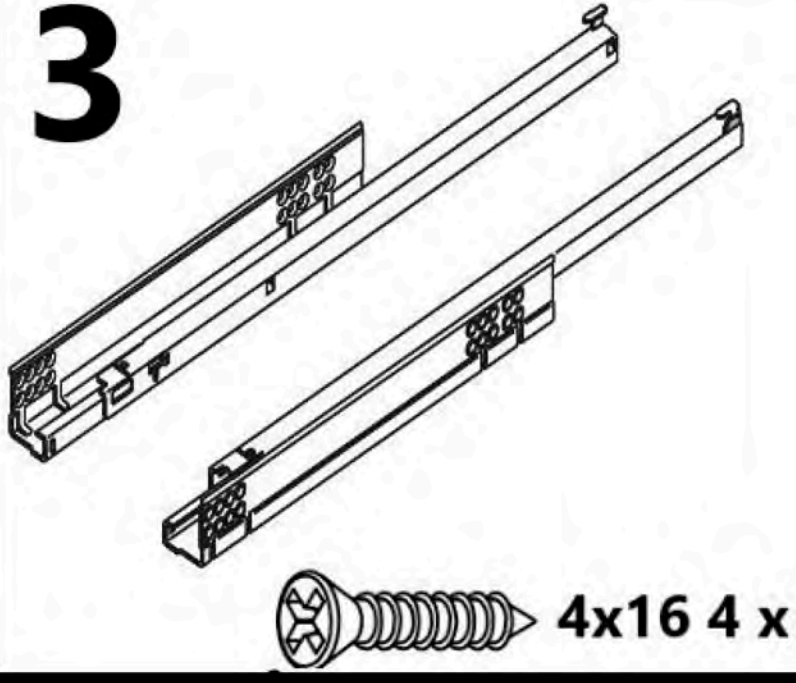

3302-92

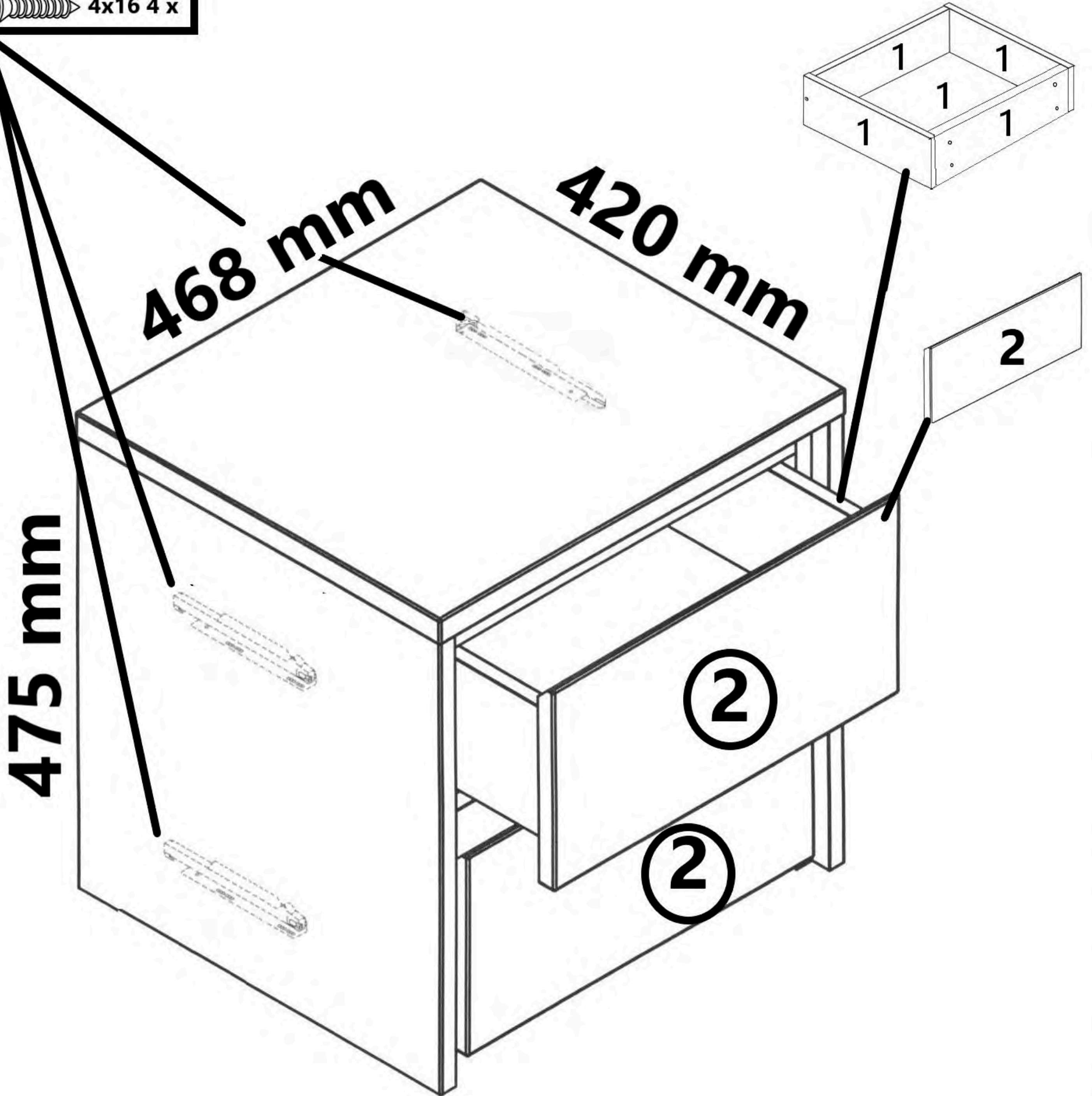

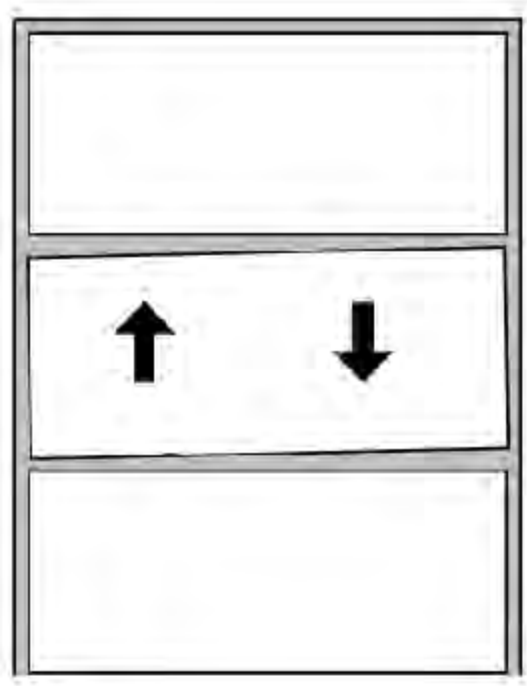

+ - 2 mm

1.

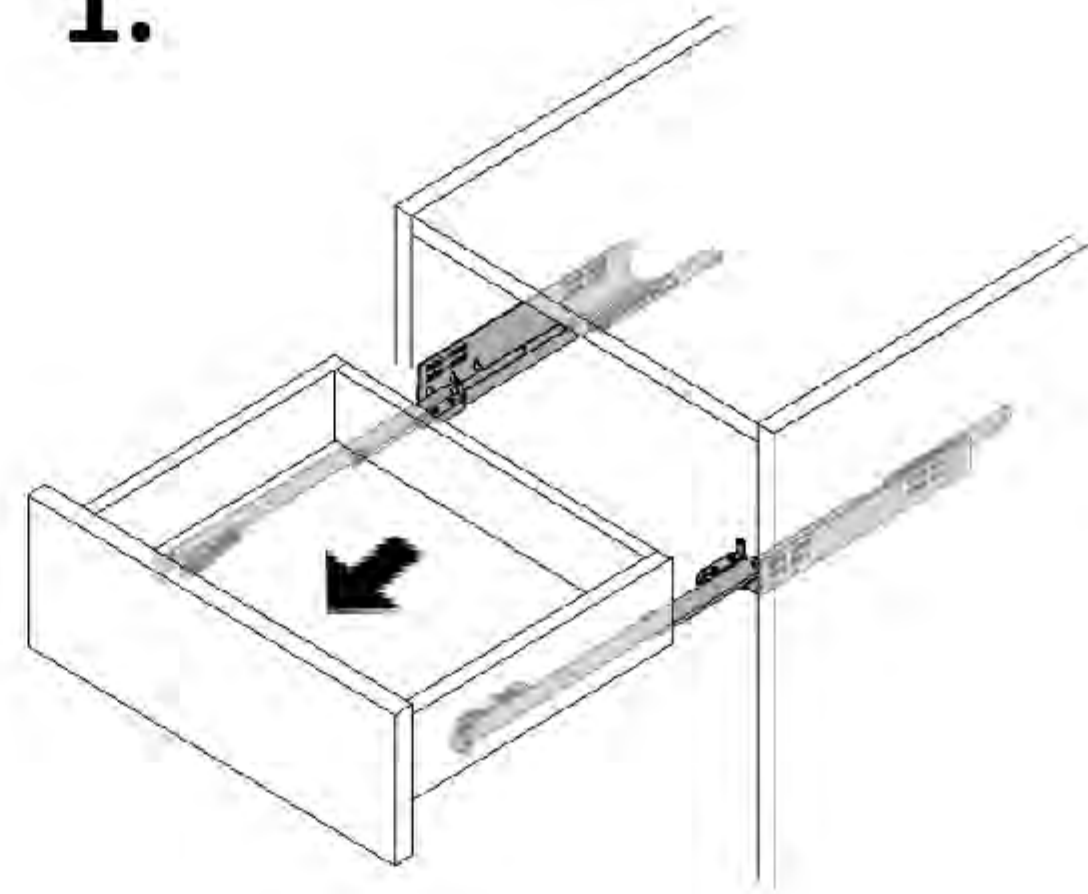

2.

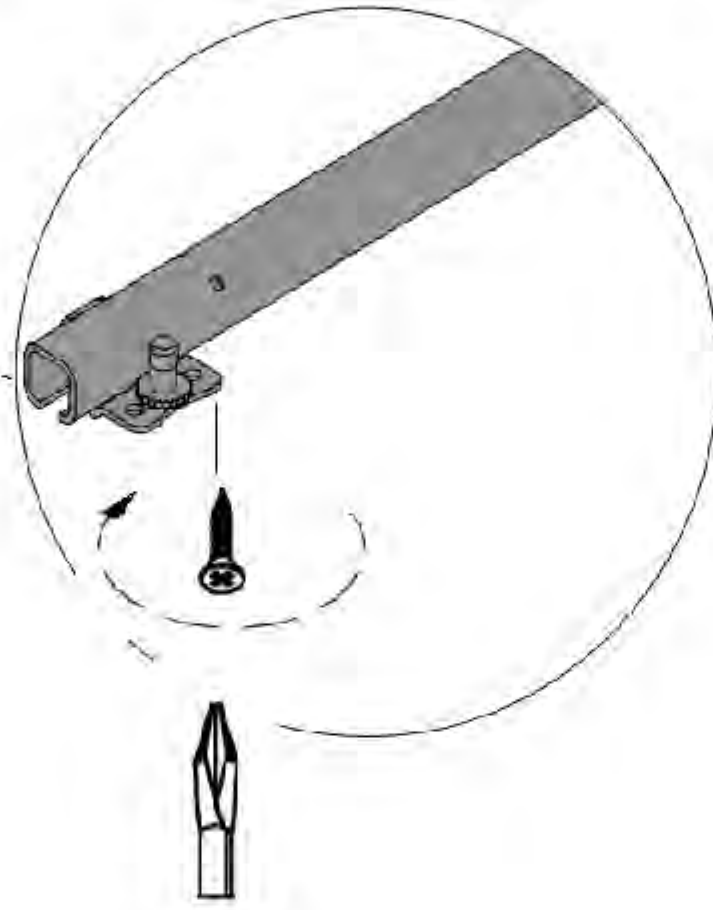
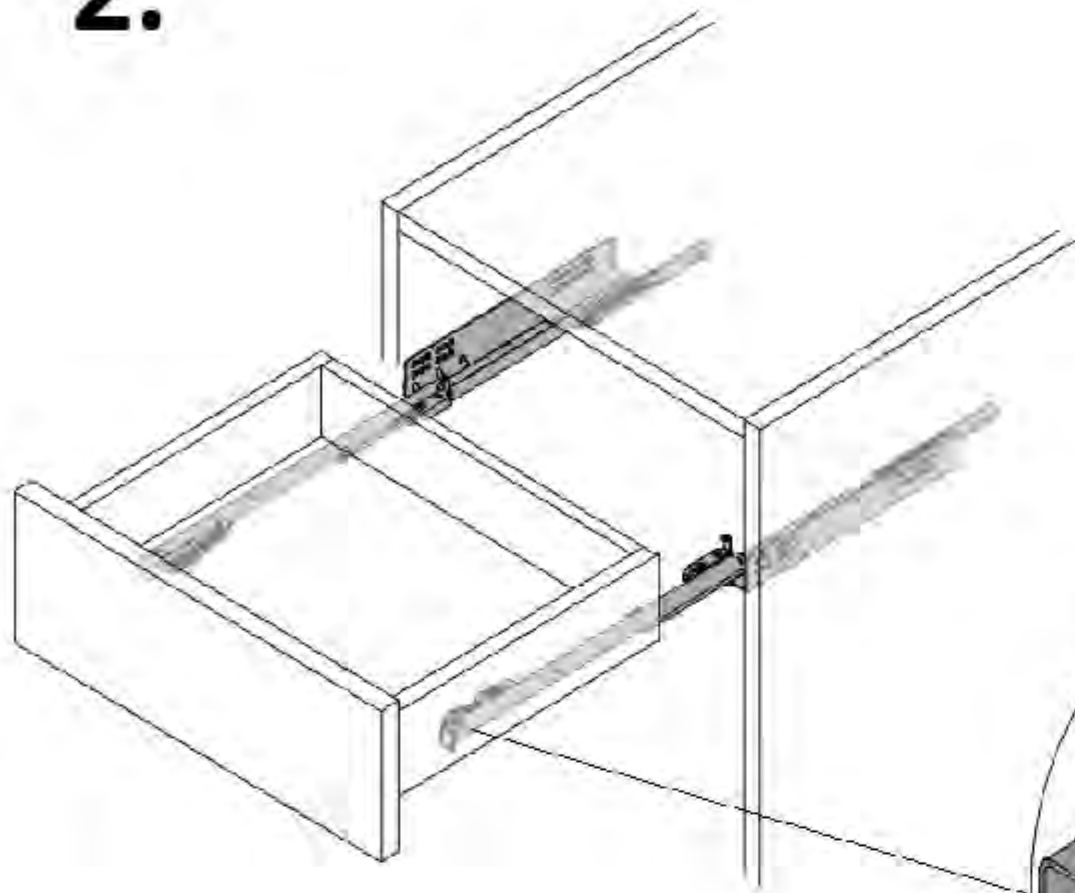

3.

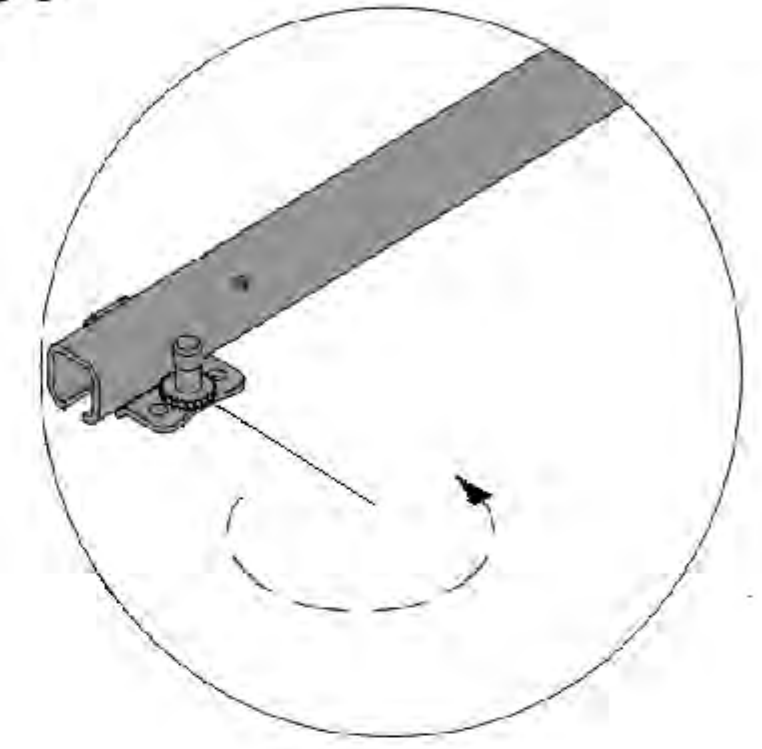

4.

