

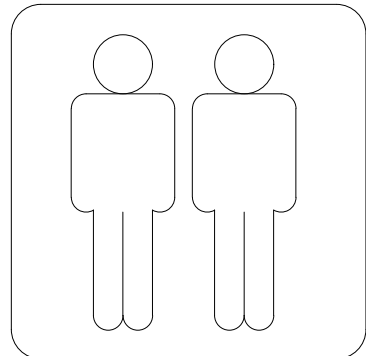

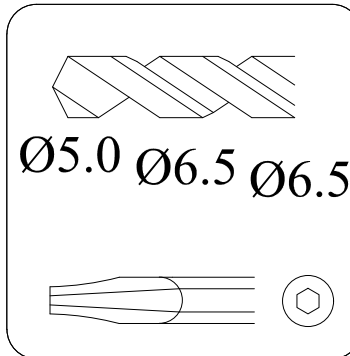

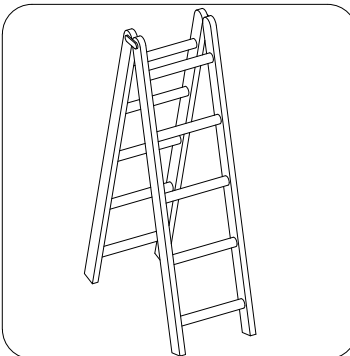

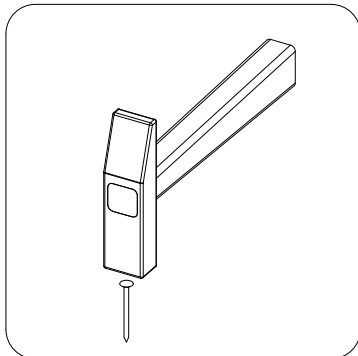

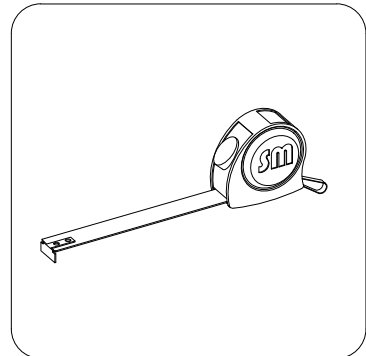
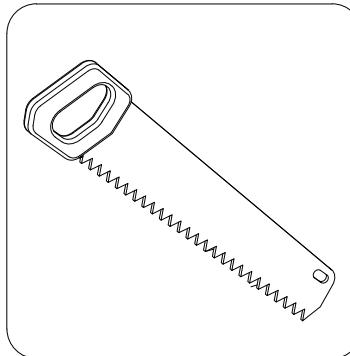
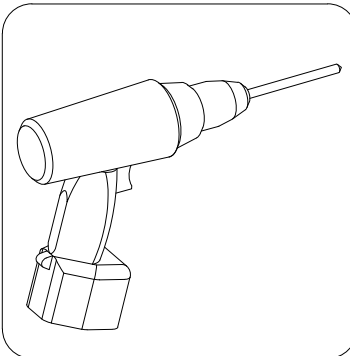
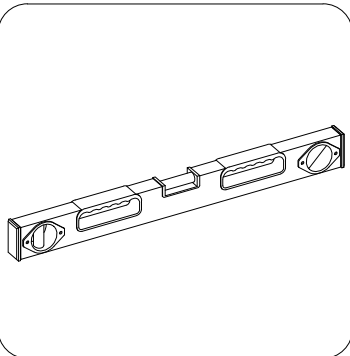
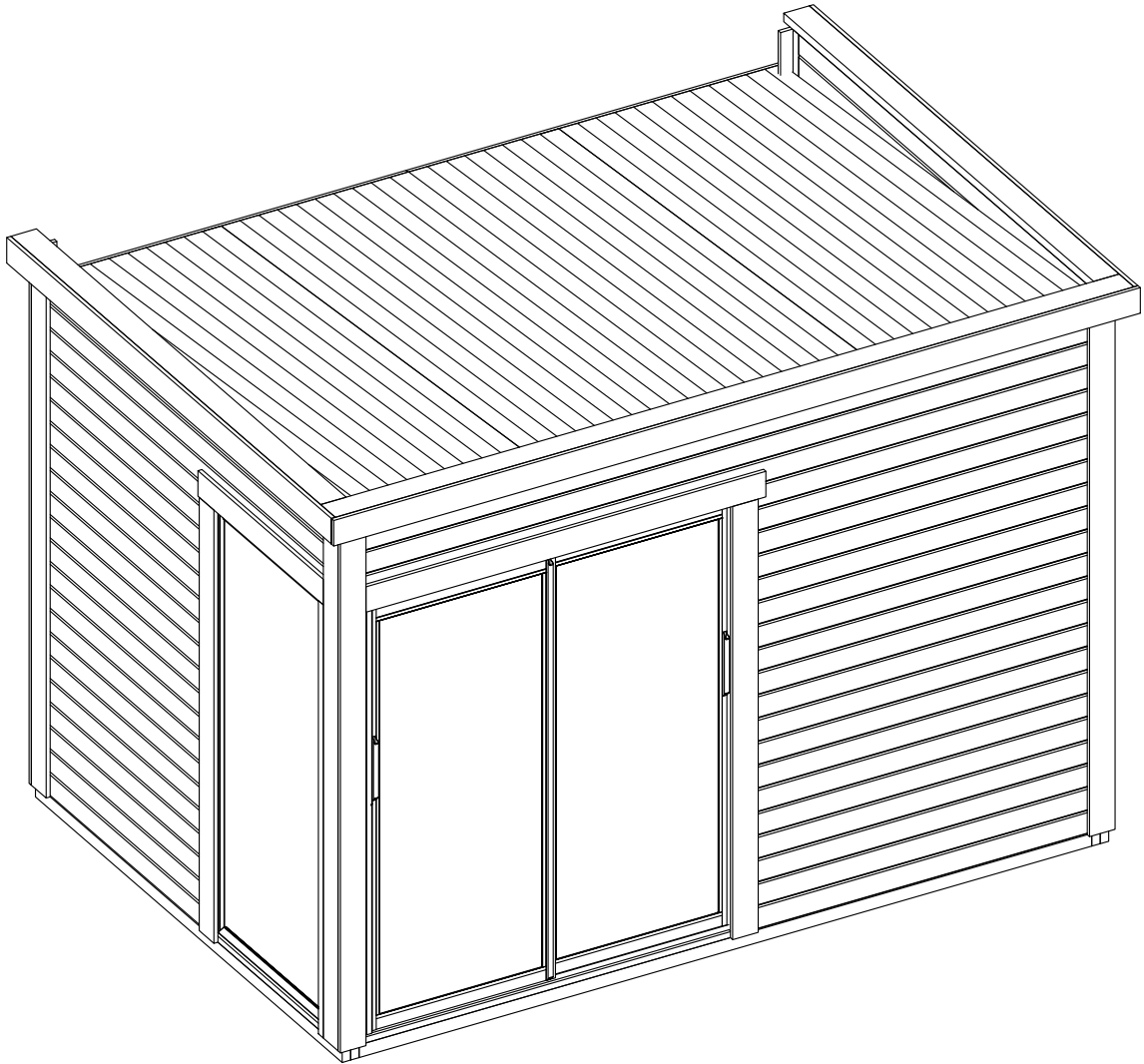
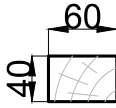
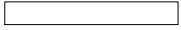

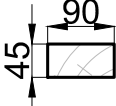



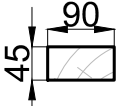

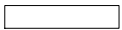
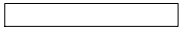
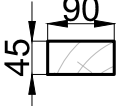

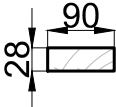
MONTAGEANLEITUNG

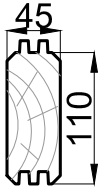
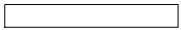
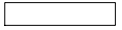
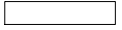
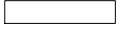

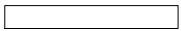
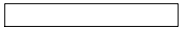
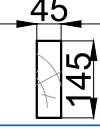

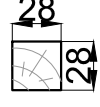





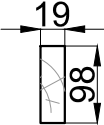

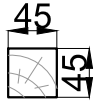

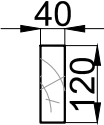
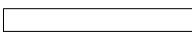
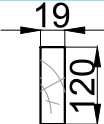

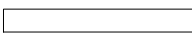
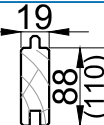

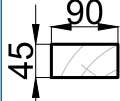
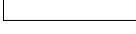
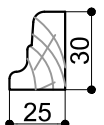
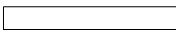

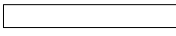
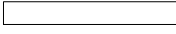
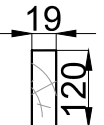
SPEZIFIKATION

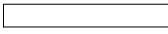



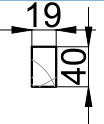



FUNDAMENTBALKEN						
		①	3440	8	FUNDAMENTBALKEN	
		②	2495	4	FUNDAMENTBALKEN	
		③	400	9	FUNDAMENTBALKEN	
RAHMENBRETT						
		④	2300	2	RAHMENBRETT	
		⑤	2180	2	RAHMENBRETT	
		⑥	2090	4	RAHMENBRETT	
		⑦	2470	2	RAHMENBRETT	
		⑧	945	1	RAHMENBRETT	
		⑨	900	1	RAHMENBRETT	
		⑩	3420	1	RAHMENBRETT	
		⑪	1781	1	RAHMENBRETT	
		⑫	1736	1	RAHMENBRETT	
		⑬	900	1	RAHMENBRETT	
		⑭	1736	1	RAHMENBRETT	
WANDBRETT						
		⑮	3600	23	BRETT FÜR VORDER-/RÜCKSEITE	20+3
		⑯	2400	25	BRETT FÜR SEITENWAND	22+3
		⑰	1729	19	BRETT FÜR SEITENWAND	19
		⑱	1365	19	BRETT FÜR SEITENWAND	19
		⑲	3600	2	BRETT FÜR VORDER-/RÜCKSEITE	1+1
		⑳	2400	2	BRETT FÜR VORDER-/RÜCKSEITE	1+1
DACHBRETT						
		㉑	3510	3	DACHSPARREN	
		㉒	2540	40+1 (32+1)	DACHBRETT	
		㉓	1755	2	WINDBRETT LEISTE	



PRECÍZÁ GARINÁŠANA

SPEZIFIKATION

DACHBRETTER						
		②④	1755	2	WINDBRETT	
		②⑤	220	2	DACHBRETT LEISTE	
		②⑥	3750	1	WINDBRETT	
		②⑦	2520	2	WINDBRETT	
		②⑧	3788	1	WINDBRETT	
		②⑨	2640	2	WINDBRETT	
BODENBRETTER						
		③⑩	2355	40+1 (32+1)	BODENBRETT	
		③⑪	1549	1	BODENLEISTE	
		③⑫	3420	1	BODENLEISTE	
		③⑬	2255	1	BODENLEISTE	
		③⑭	1190	1	BODENLEISTE	
		③⑮	1640	1	BODENLEISTE	
RAHMENBLENDEN						
		③⑯	2300	2	RAHMENBLENDE	
		③⑰	2520	8	RAHMENBLENDE	
		③⑱	2035	2	RAHMENBLENDE	
		③⑲	1020	1	RAHMENBLENDE	
		③⑳	1880	1	RAHMENBLENDE	
		③㉑	2035	1	RAHMENBLENDE	

SPEZIFIKATION

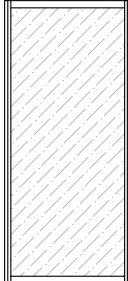
SCHIEBETÜR-SYSTEM						
		A1	1736	1	UNTERE SCHIENE	
		A2	1736	1	OBERE SCHIENE	
		B1	2000	1	SEITENPROFIL	
		B2	2000	1	SEITENPROFIL	

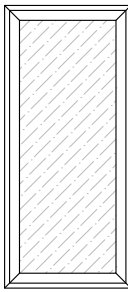
GLASSCHIEBETÜR					
	D1	.	1	GLASSCHIEBETÜR	
	D2	.	1	GLASSCHIEBETÜR	
	D5	900x2017	1	GLASSCHIEBETÜR	

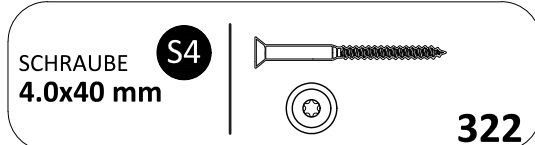
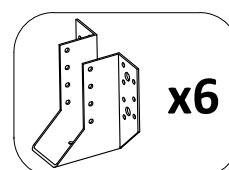
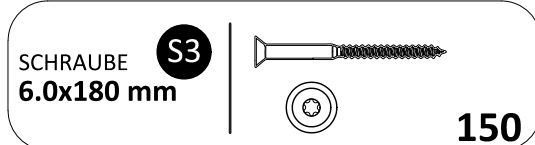
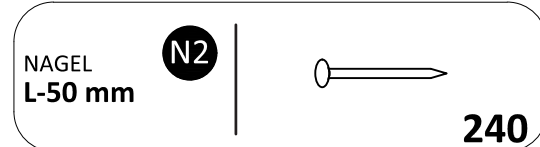
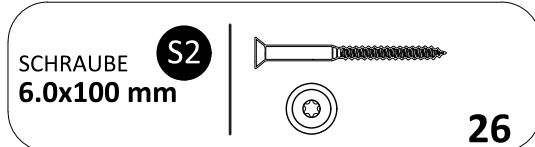
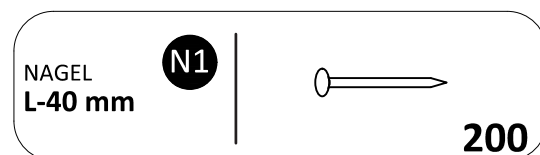
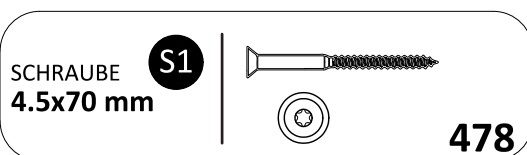

WÄNDE

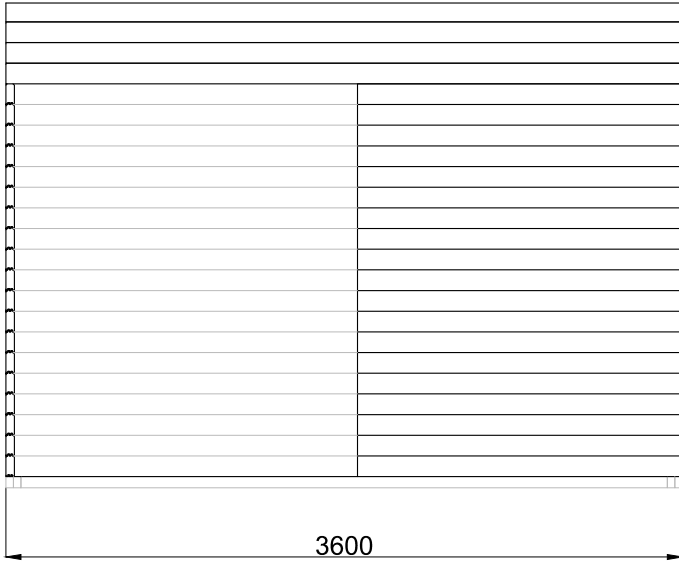

23
22
21
20
19
18
17
16
15
14
13
12
11
10
9
8
7
6
5
4
3
2
1

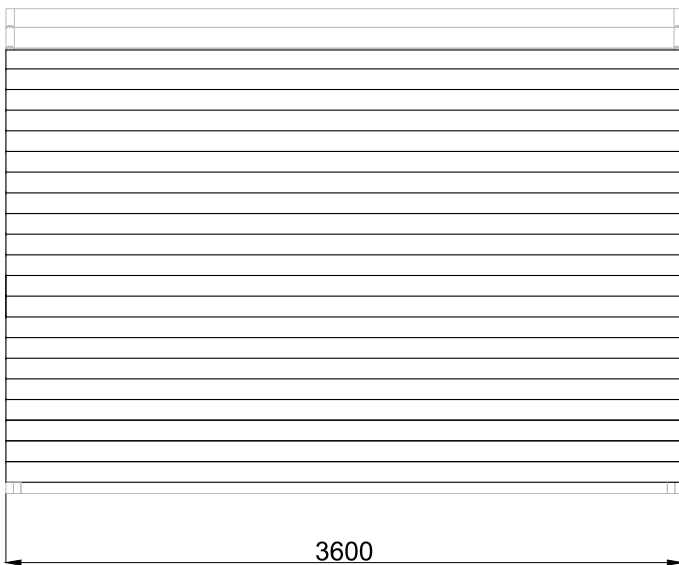
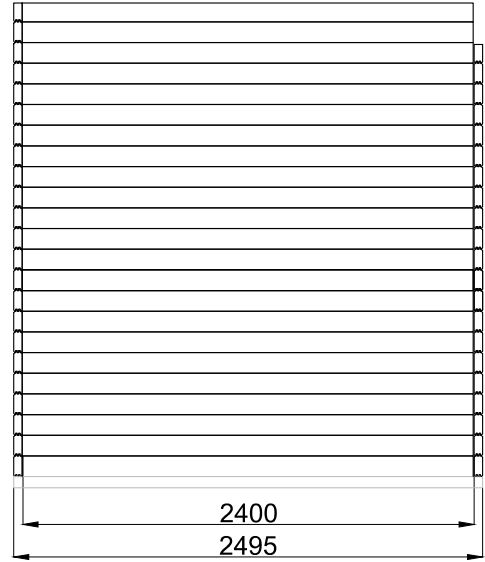



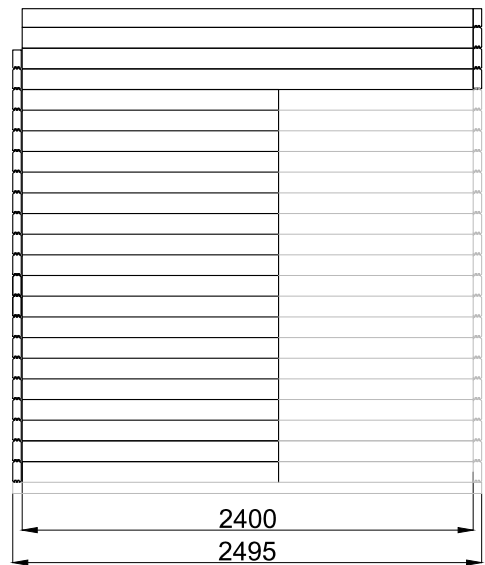

23
22
21
20
19
18
17
16
15
14
13
12
11
10
9
8
7
6
5
4
3
2
1

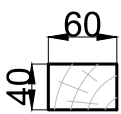

FUNDAMENTTRAHMEN - ANLEITUNG

FUNDAMENTTRAHMEN ZUBEHÖR

		①	3440	8	FUNDAMENTBALKEN
		②	2495	4	FUNDAMENTBALKEN
		③	400	9	FUNDAMENTBALKEN

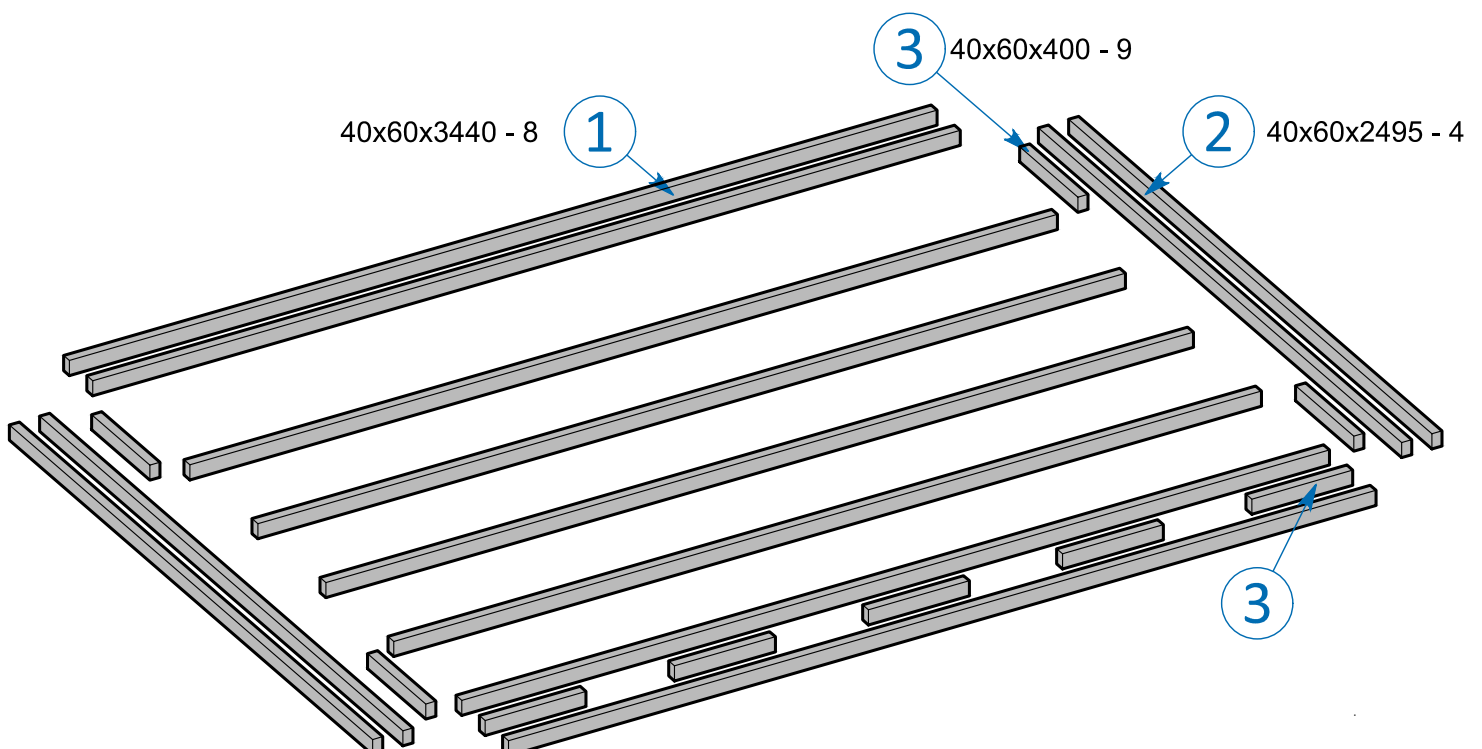
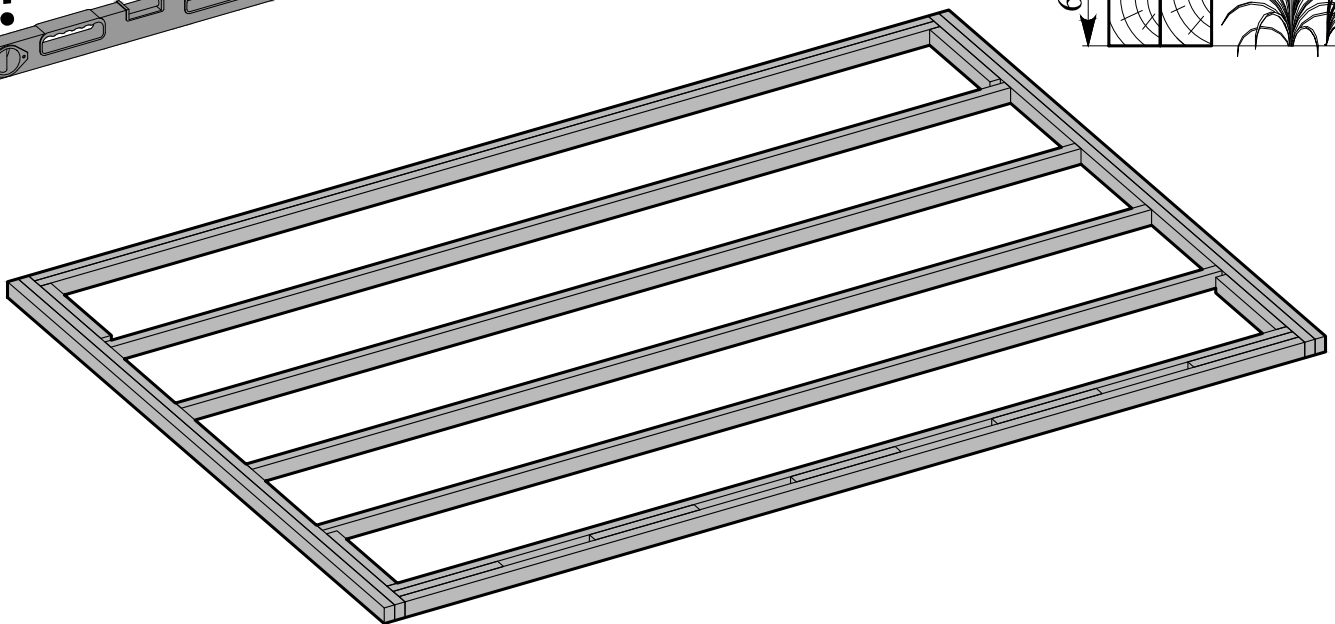
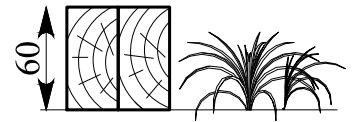
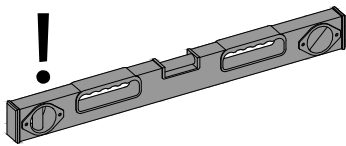

FUNDAMENTTRAHMEN MONTAGE

SCHRAUBE
4.5x70 mm S1

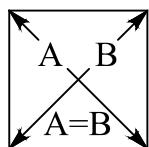
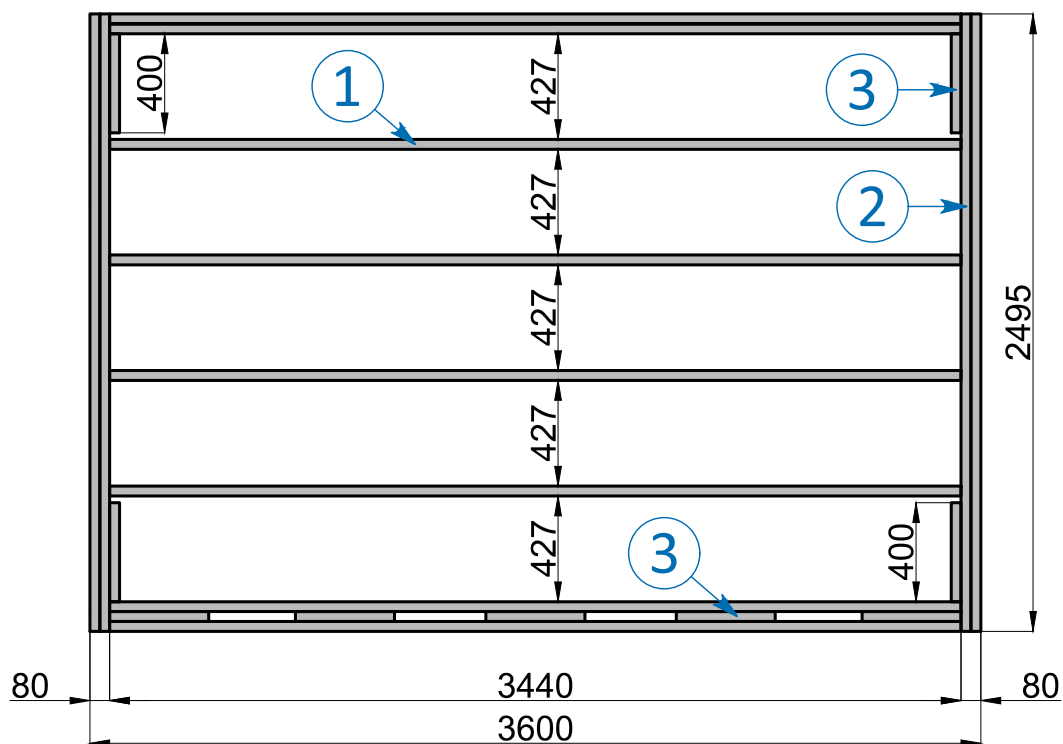

A=B=4380mm

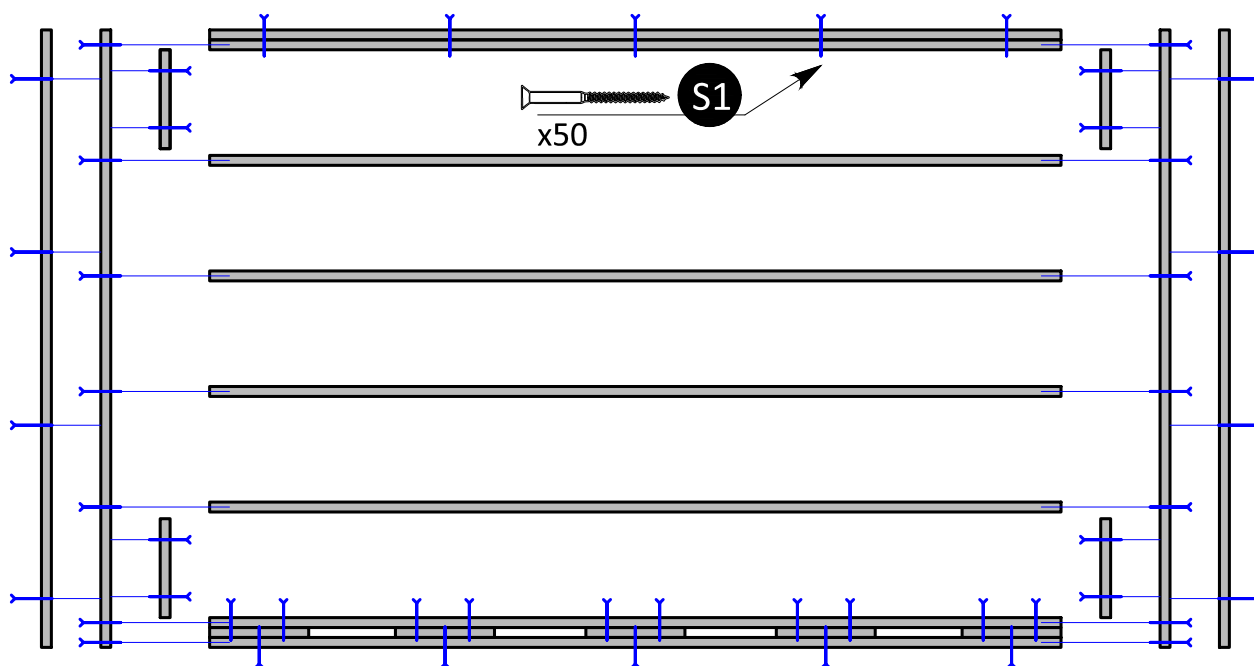



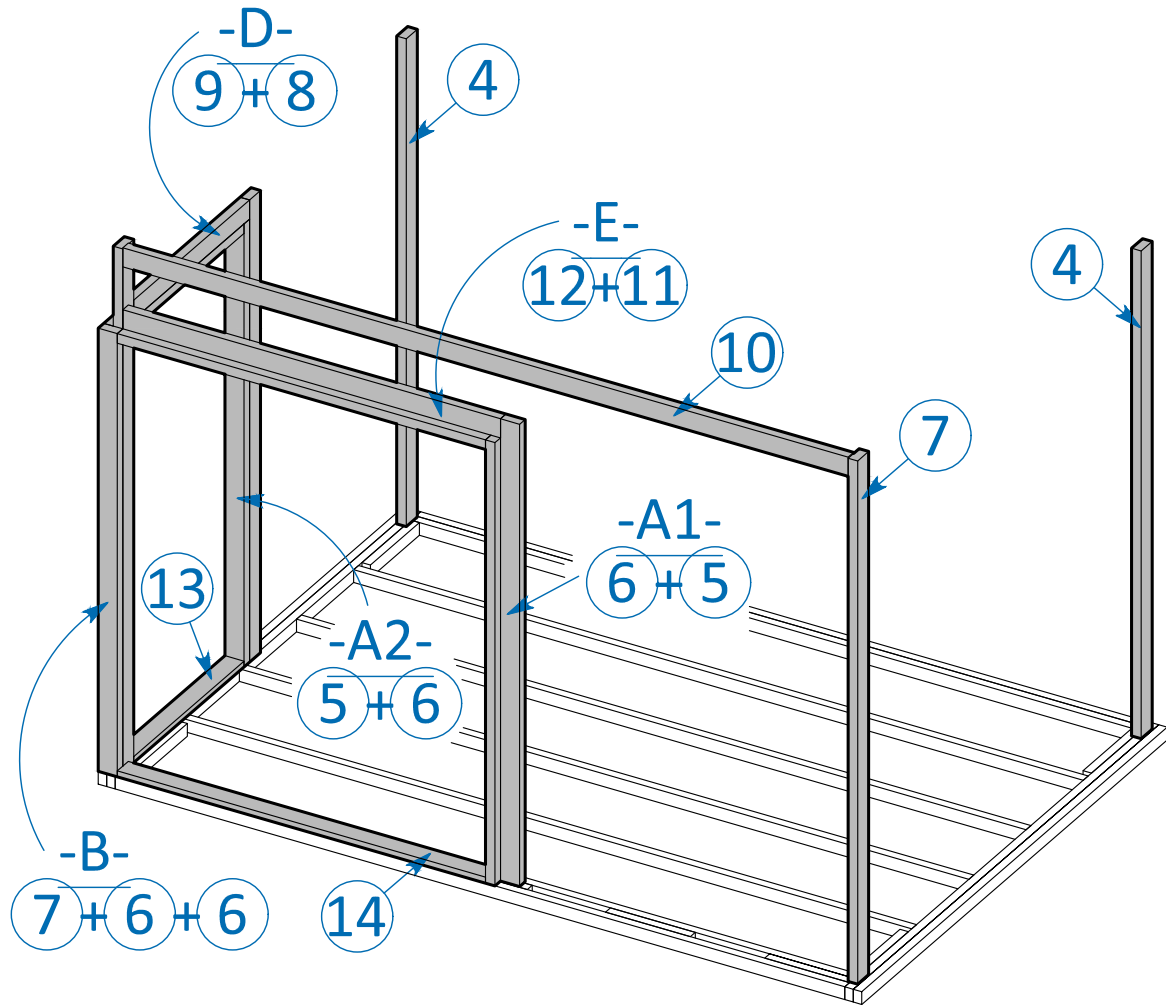

SCHRAUBE
4.5x70 mm S1

Vorbohren wird empfohlen.

RAHMEN - ANLEITUNG

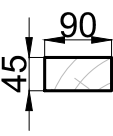

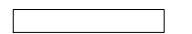
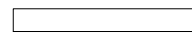
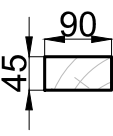
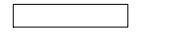
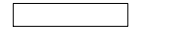
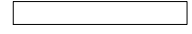
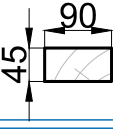
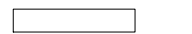
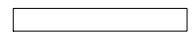
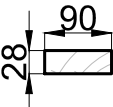
RAHMEN ZUBEHÖR

		④	2300	2	RAHMENBRETT	
		⑤	2180	2	RAHMENBRETT	
		⑥	2090	4	RAHMENBRETT	
		⑦	2470	2	RAHMENBRETT	
		⑧	945	1	RAHMENBRETT	
		⑨	900	1	RAHMENBRETT	
		⑩	3420	1	RAHMENBRETT	
		⑪	1781	1	RAHMENBRETT	
		⑫	1736	1	RAHMENBRETT	
		⑬	900	1	RAHMENBRETT	
		⑭	1736	1	RAHMENBRETT	

ABMESSUNGEN DER FENSTERÖFFNUNGEN

DRAUFSICHT

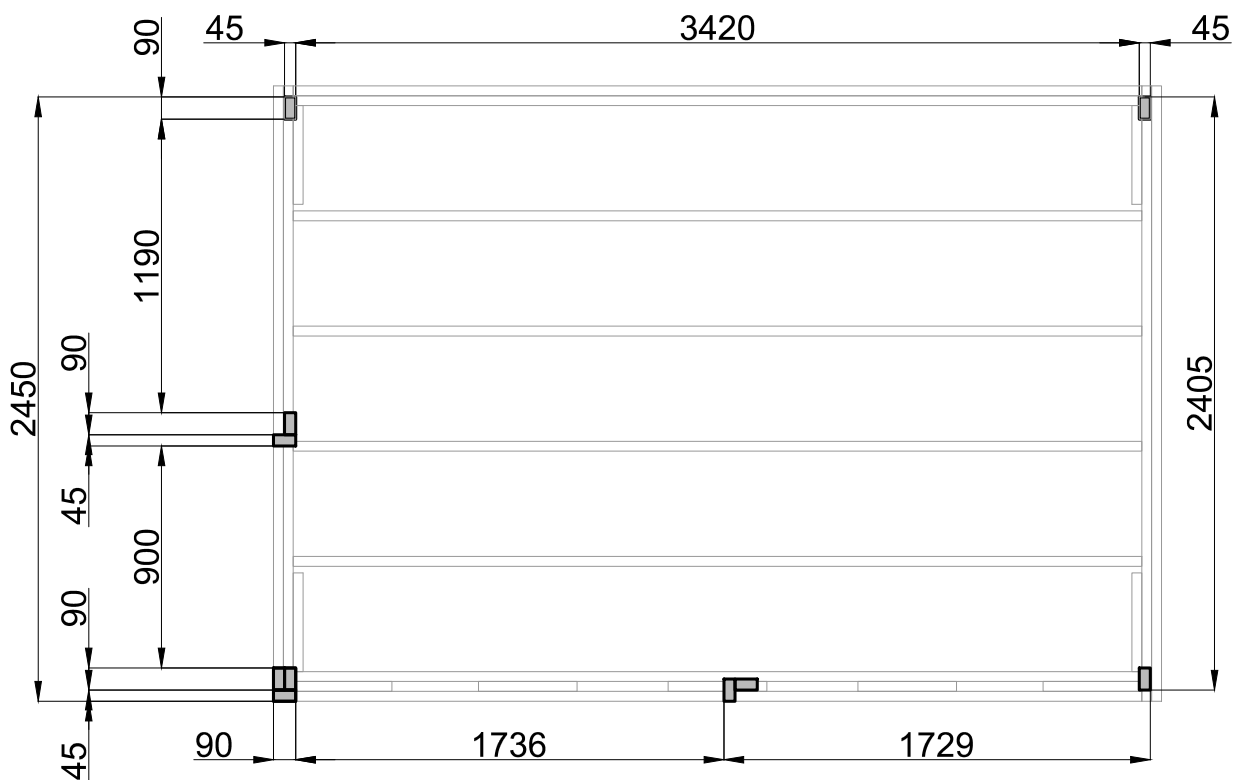

SEITE

FRONT

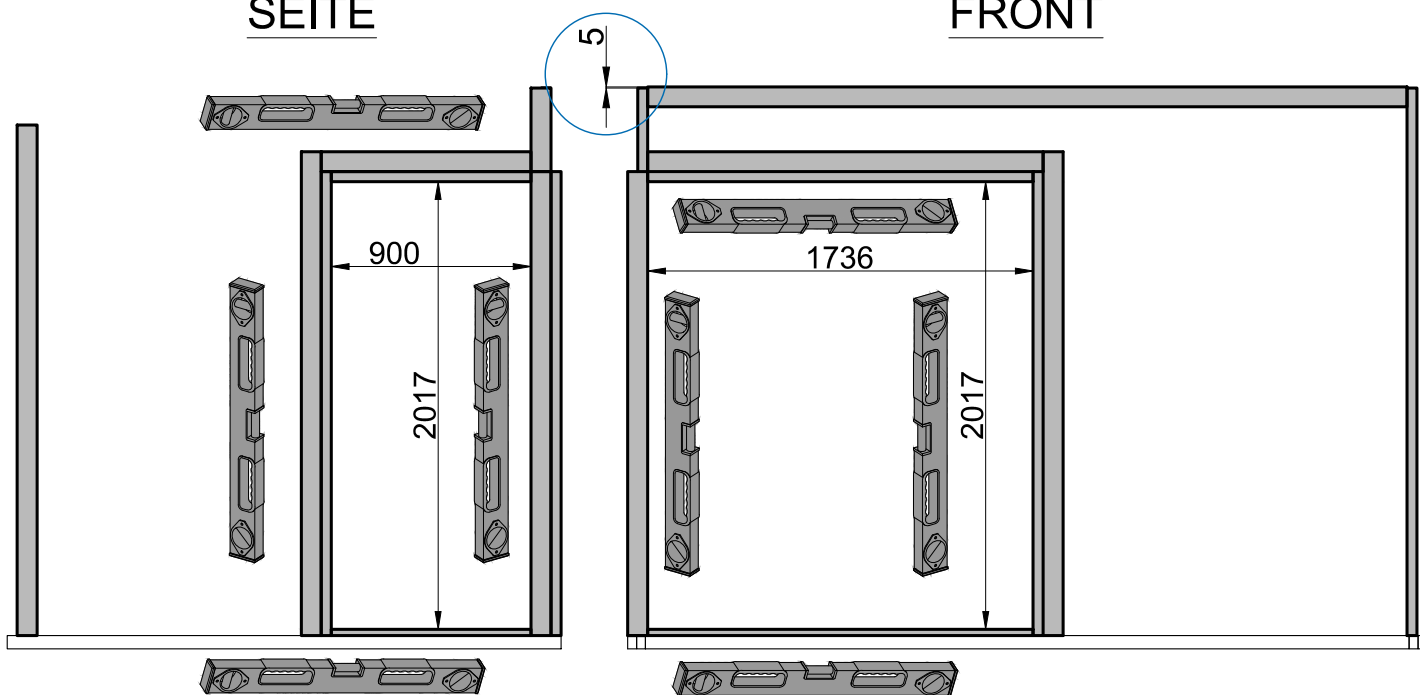

RAHMENBRETTER MONTAGE

-A1-

5+6

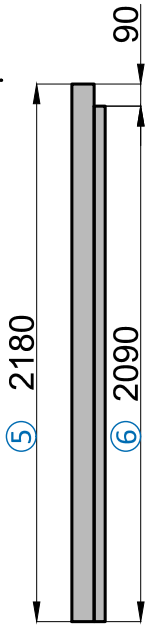
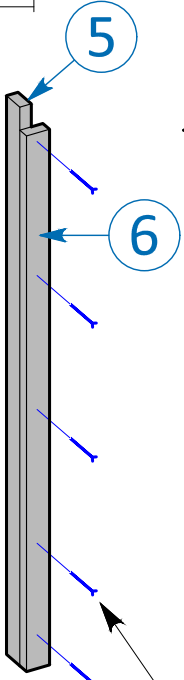
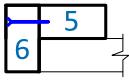

-A2-

5+6

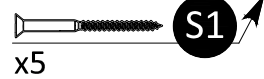
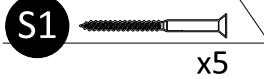
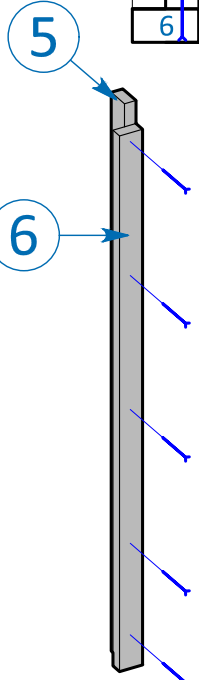
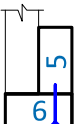

-B-

6+6+7

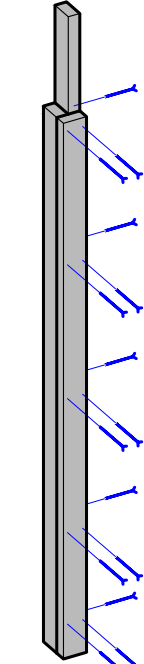
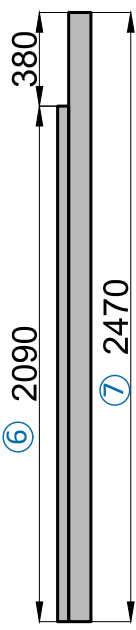
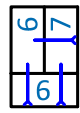

SCHRAUBE 4.5x70 mm S1

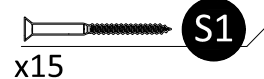

-E-

11+12

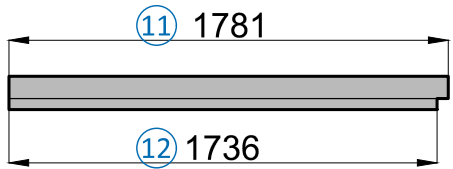
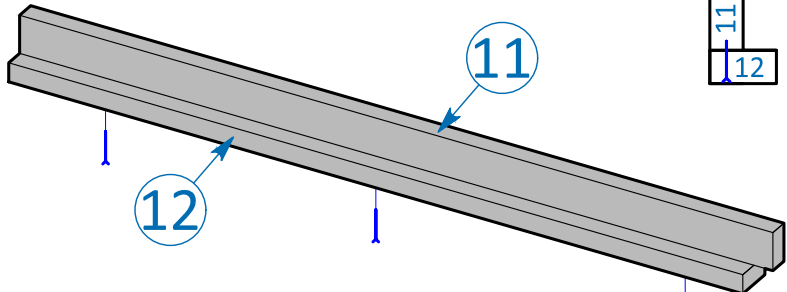
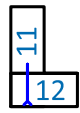

-D-

8+9

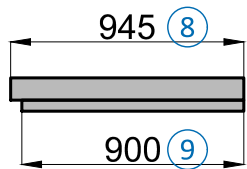
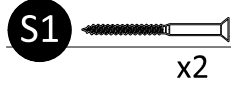
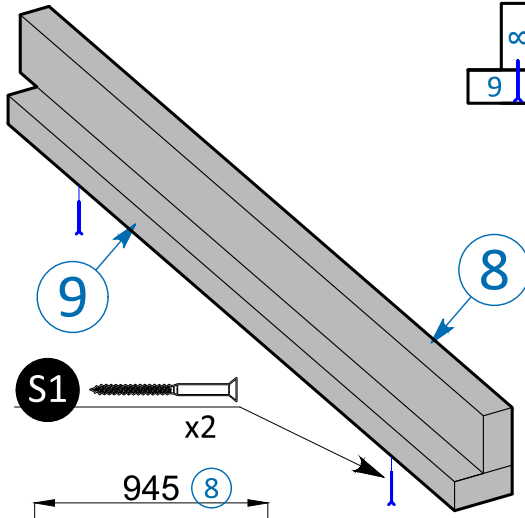
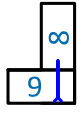

Vorbohren wird empfohlen.

RAHMEN MONTAGE

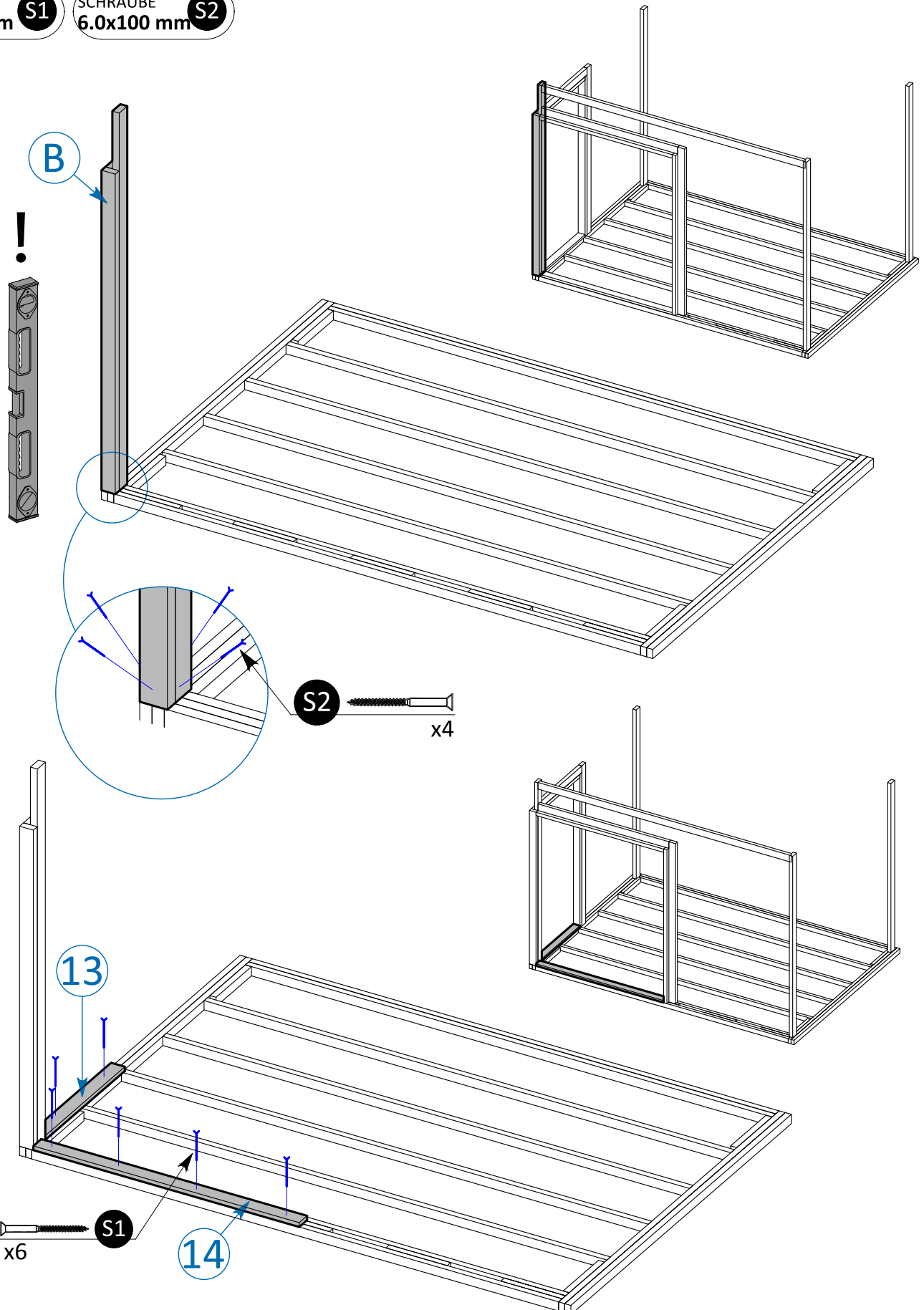
SCHRAUBE
4.5x70 mm S1SCHRAUBE
6.0x100 mm S2

Vorbohren wird empfohlen.

RAHMEN MONTAGE

SCHRAUBE 6.0x180 mm S3

SCHRAUBE 6.0x100 mm S2

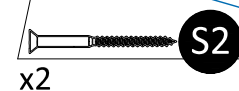
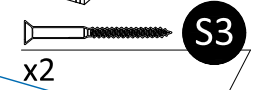
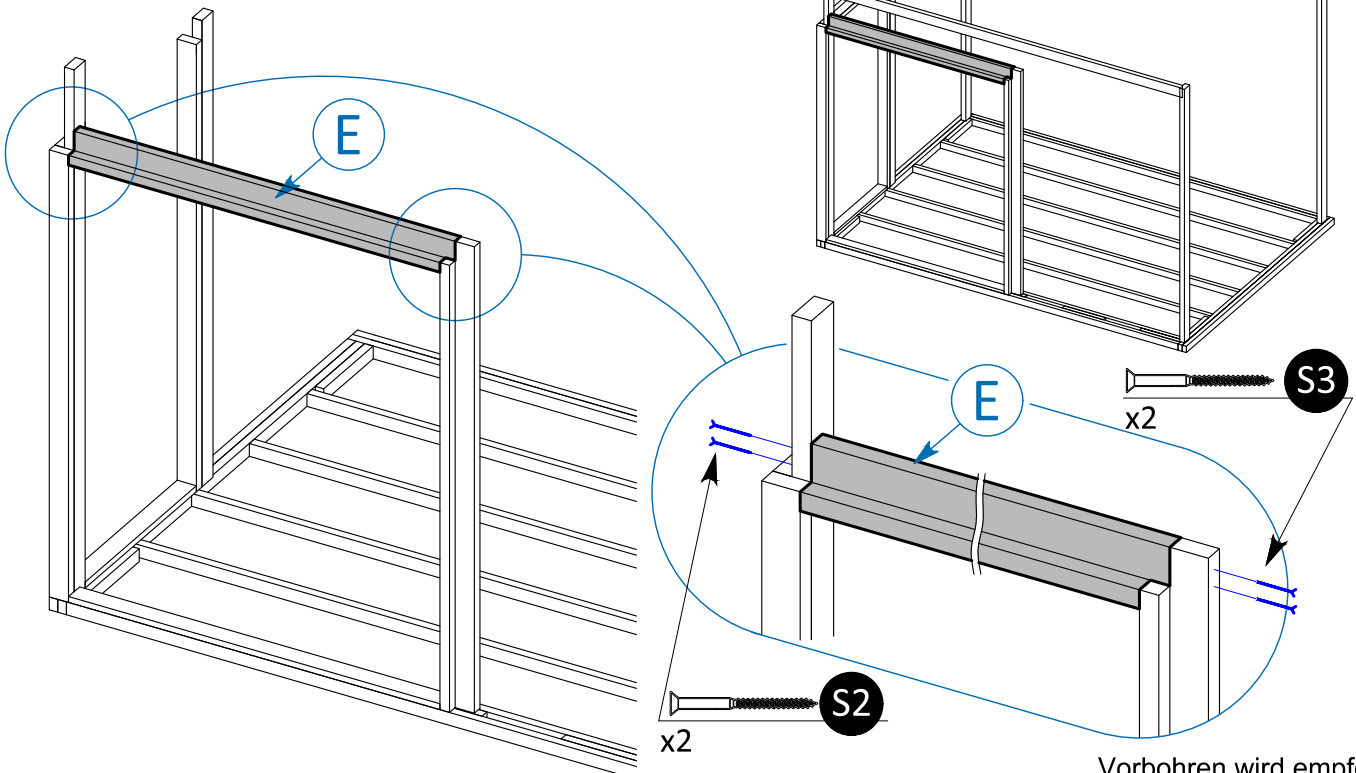
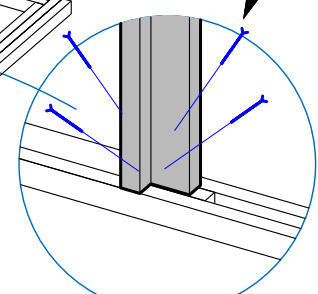
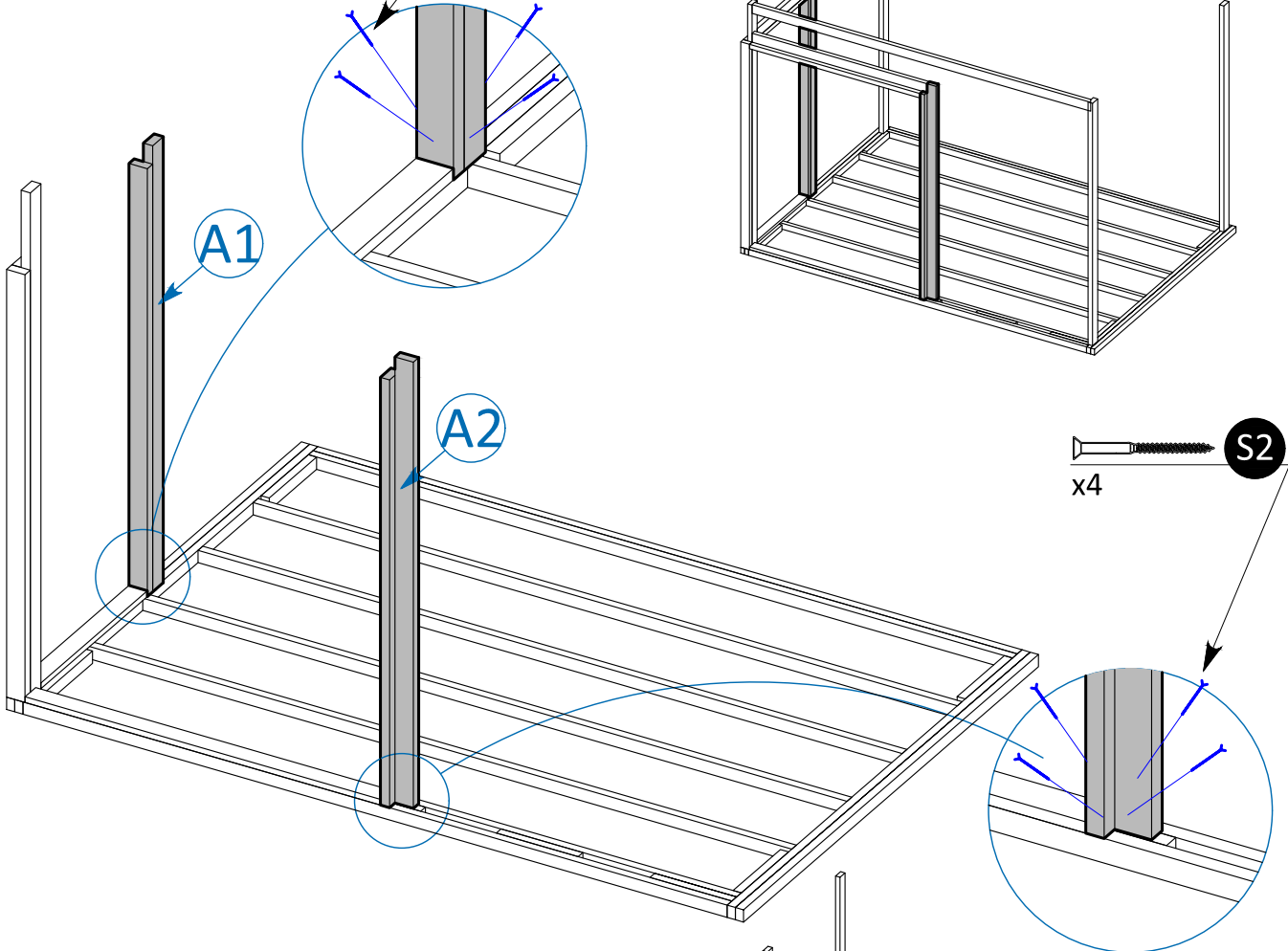
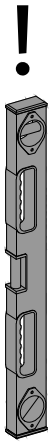
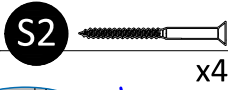

Vorbohren wird empfohlen.

RAHMEN MONTAGE

SCHRAUBE
6.0x180 mm **S3**

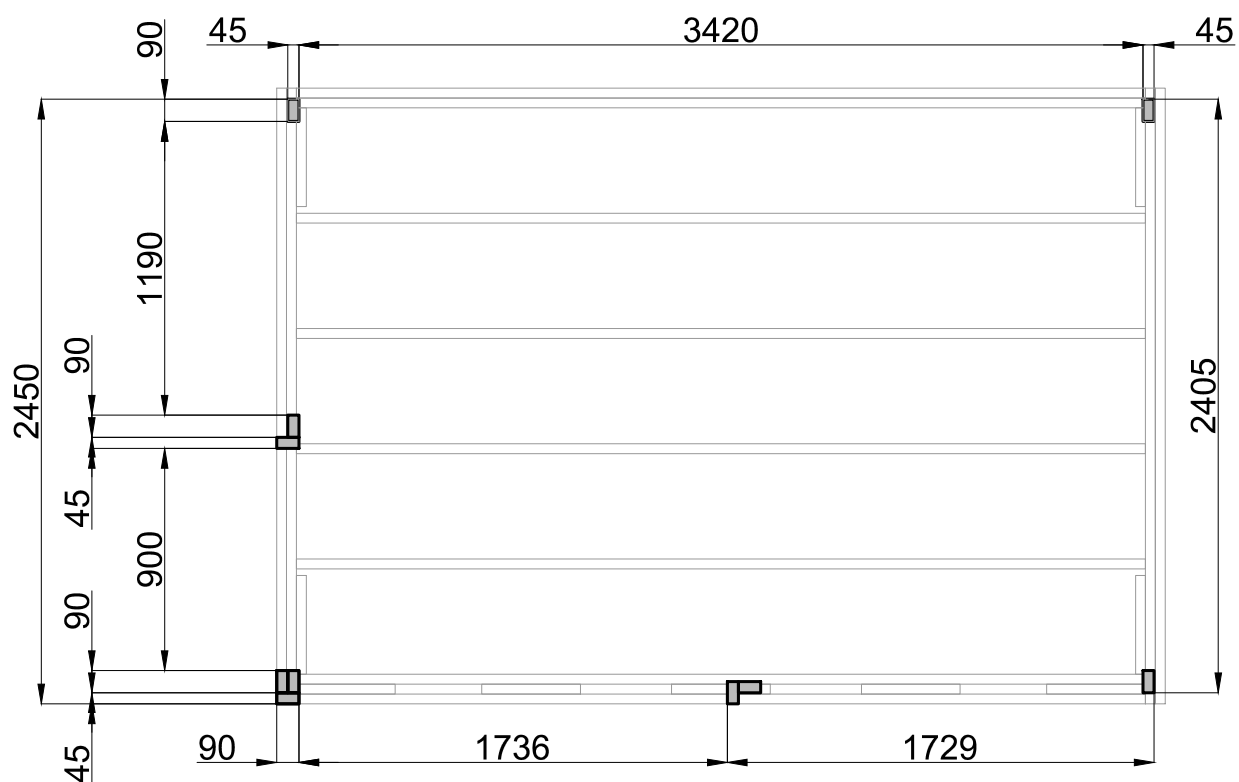
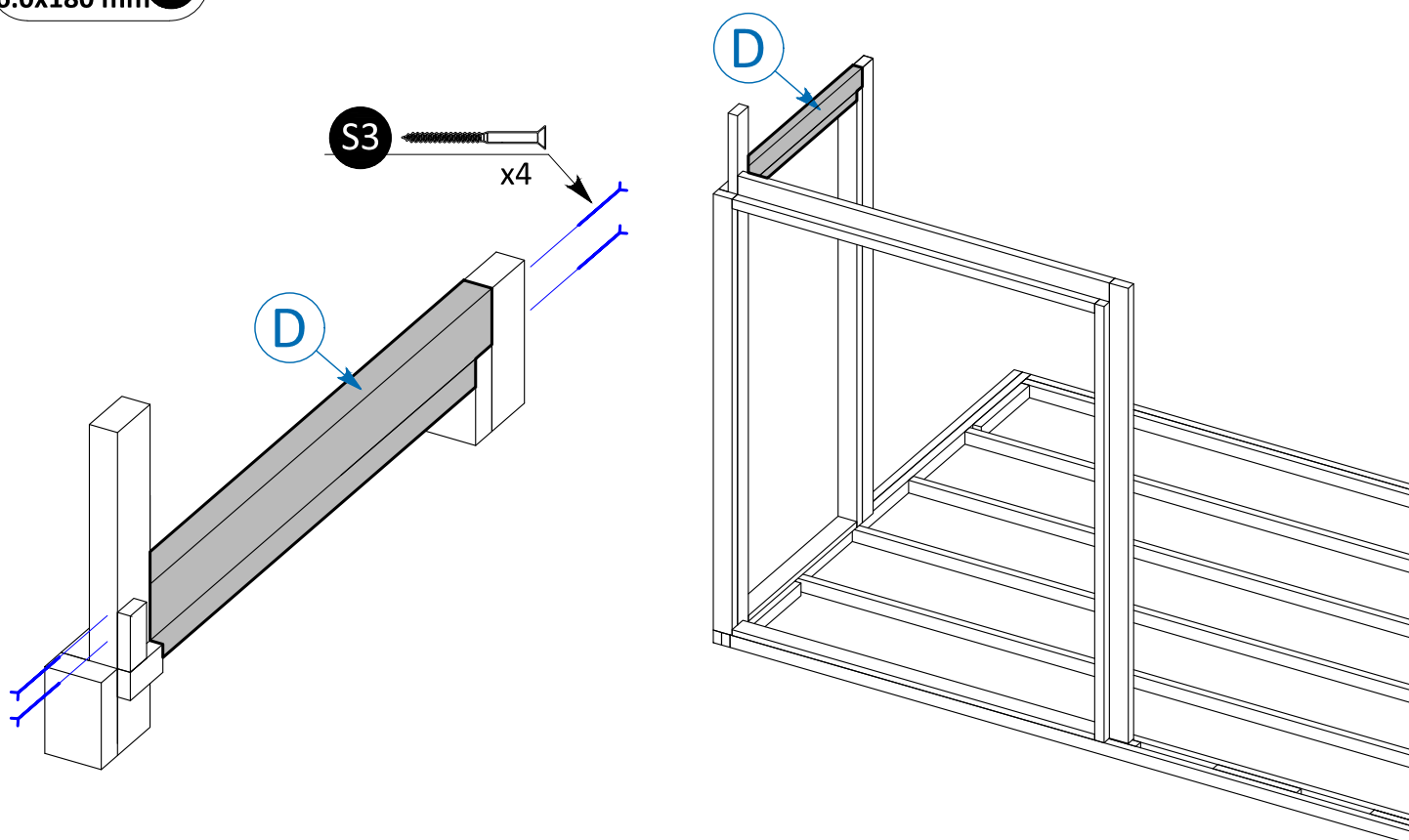

Vorbohren wird empfohlen.

RAHMEN MONTAGE

SCHRAUBE
6.0x100 mm S2

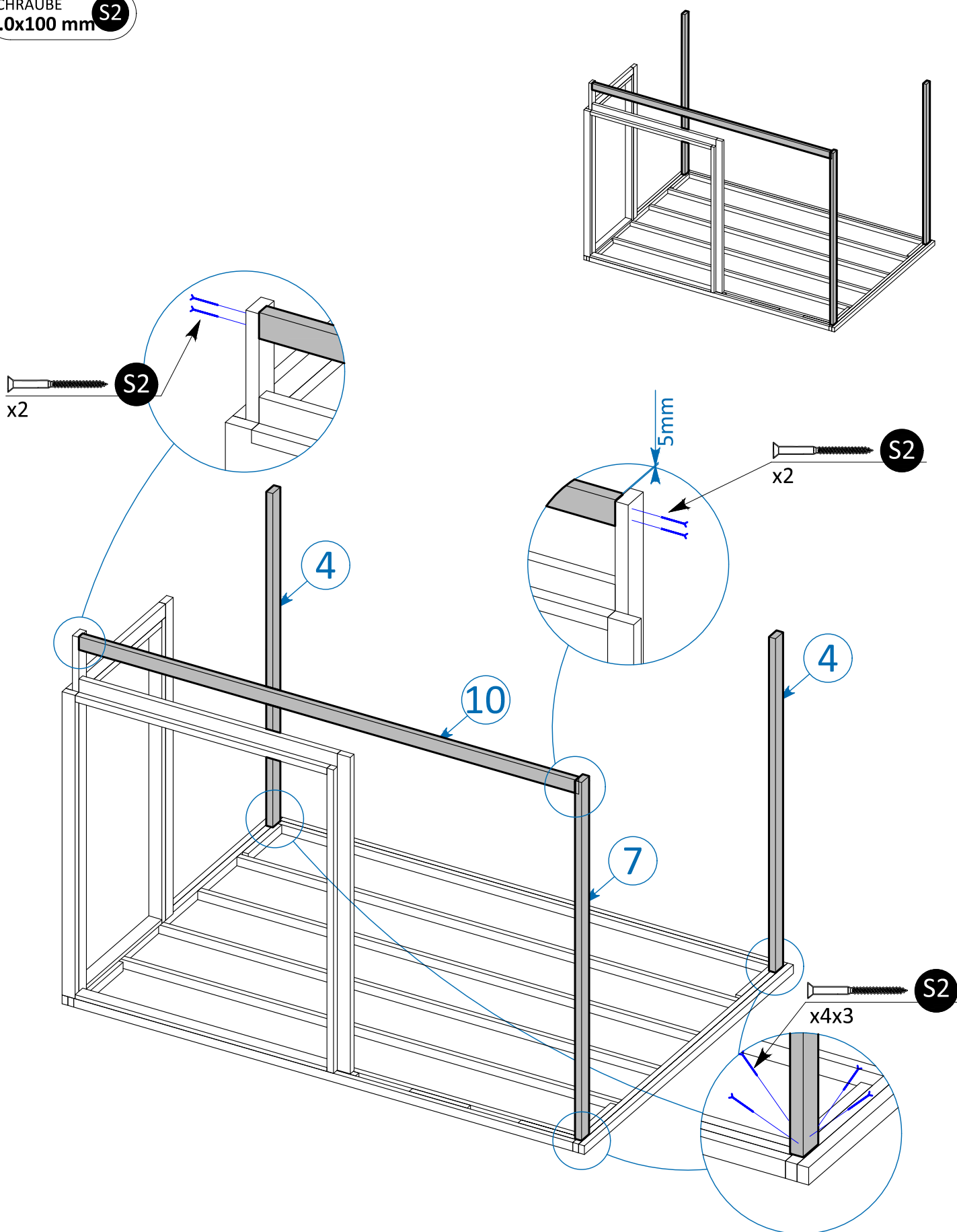

Vorbohren wird empfohlen.

RAHMEN MONTAGE

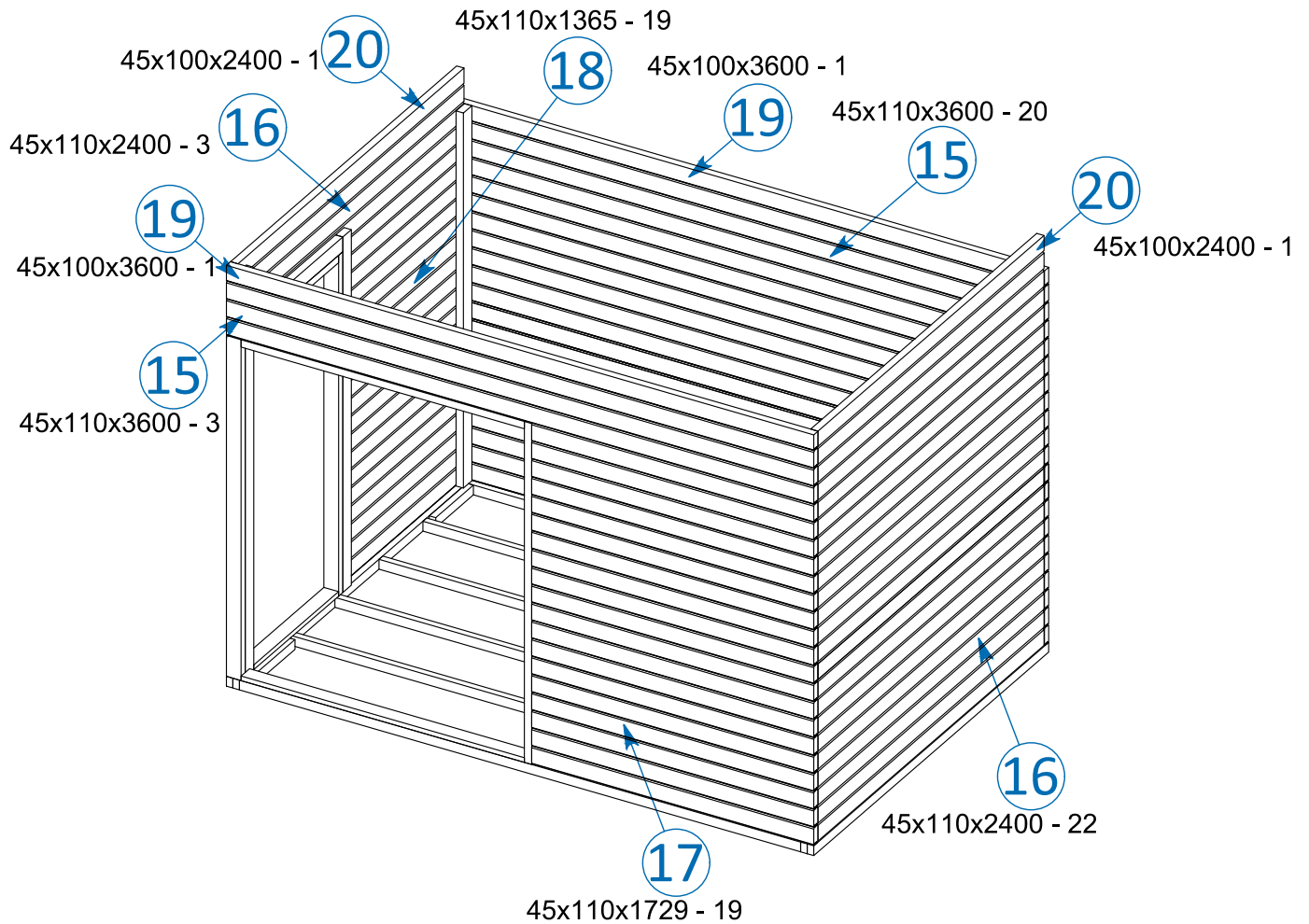

WAND ZUBEHÖR

		15	3600	23	BRETT FÜR VORDER-/RÜCKSEITE	20 +3
		16	2400	25	BRETT FÜR SEITENWAND	22+3
		17	1729	19	BRETT FÜR SEITENWAND	19
		18	1365	19	BRETT FÜR SEITENWAND	19
		19	3600	2	BRETT FÜR VORDER-/RÜCKSEITE	1+1
		20	2400	2	BRETT FÜR VORDER-/RÜCKSEITE	1+1

WAND MONTAGE

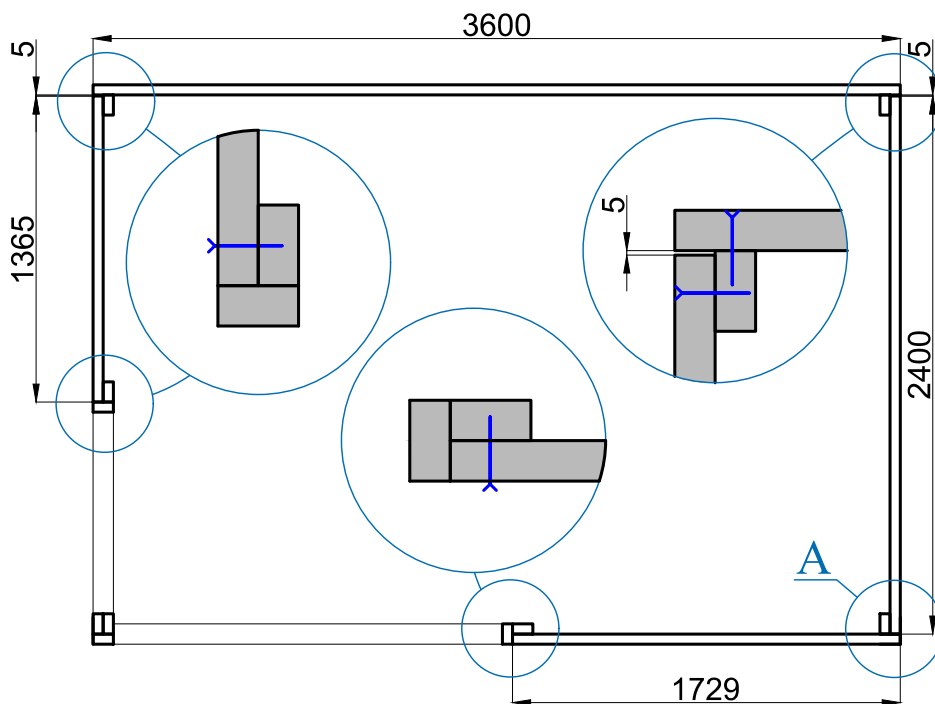
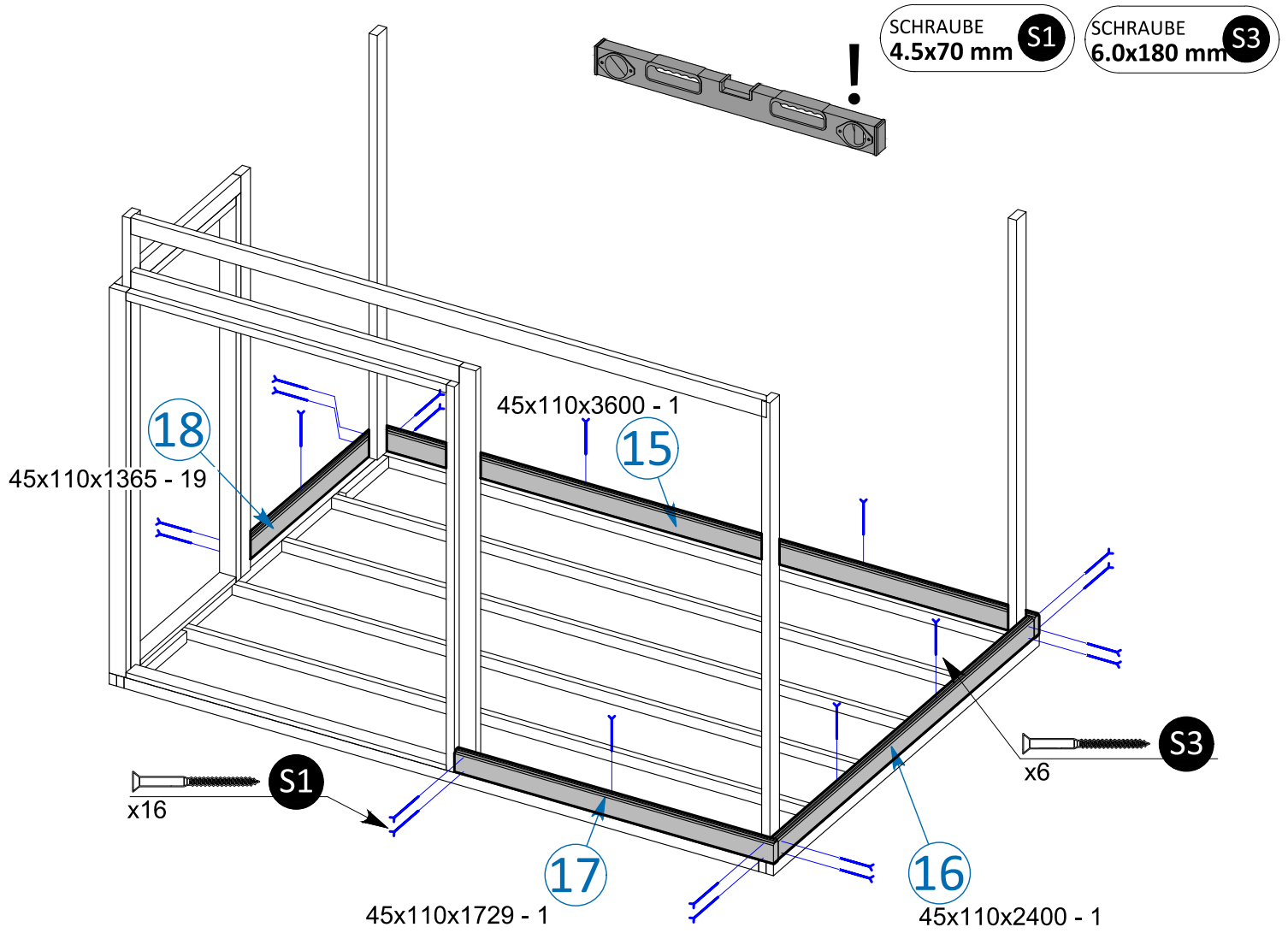

WAND MONTAGE

SCHRAUBE
4.5x70 mm S1

SCHRAUBE
6.0x180 mm S3

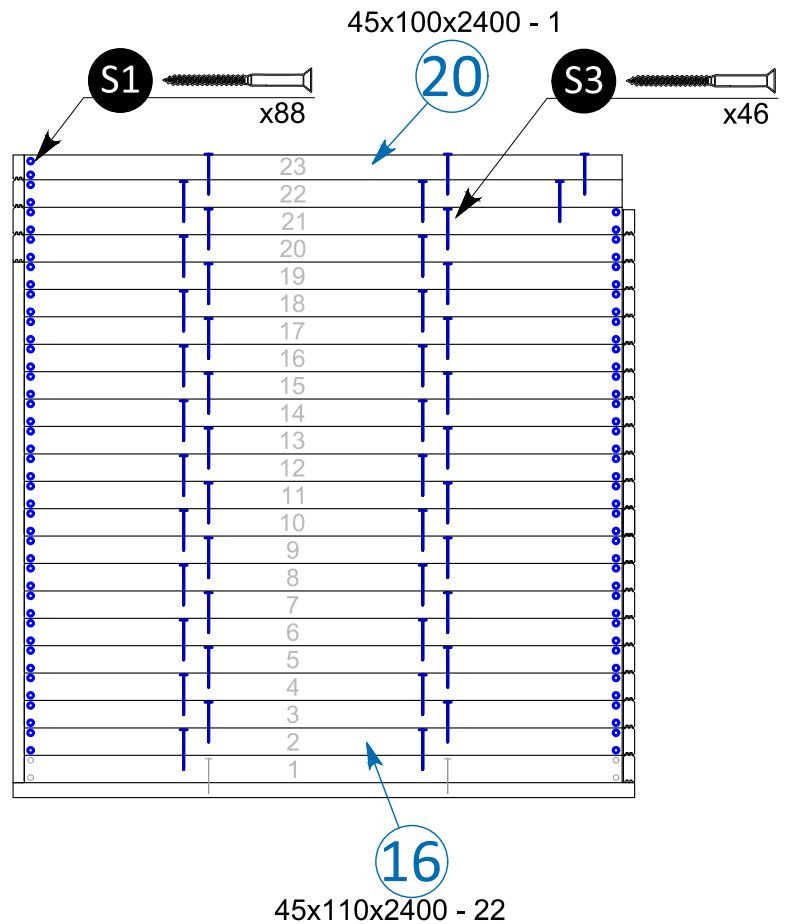
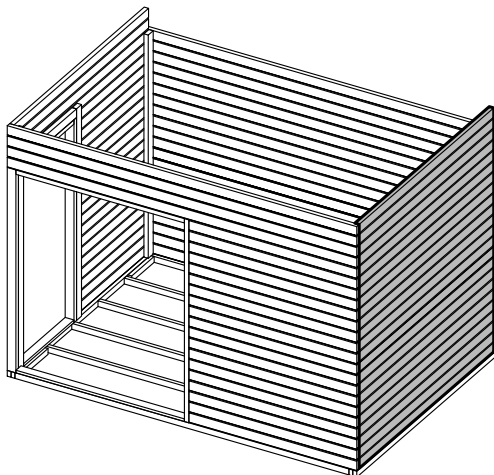
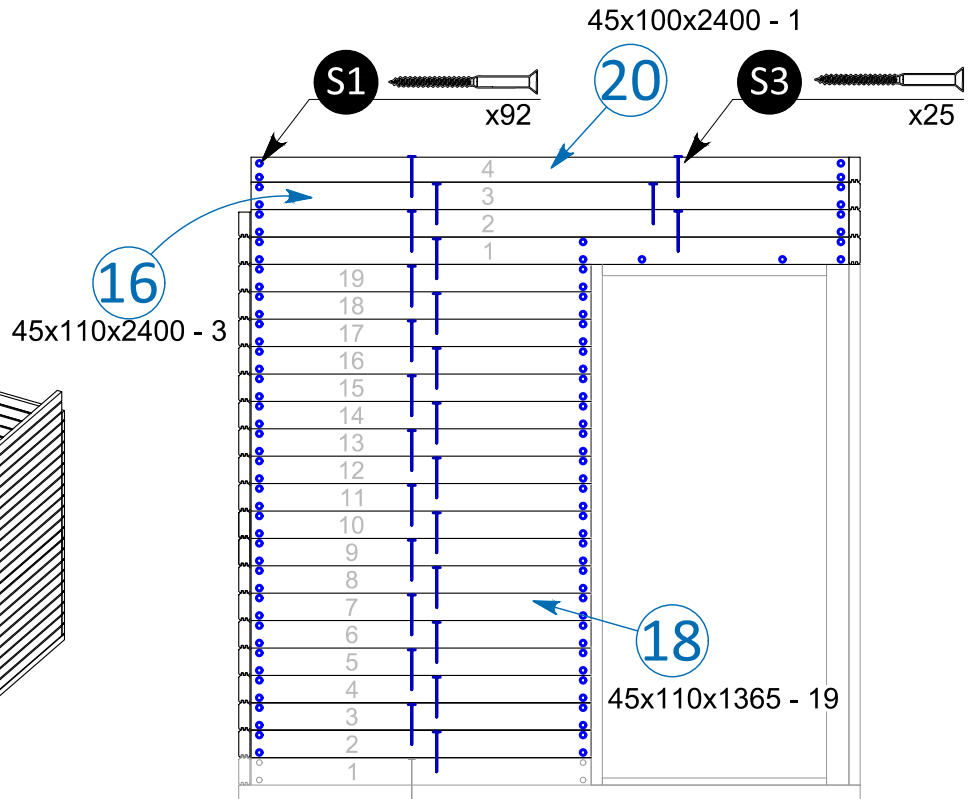
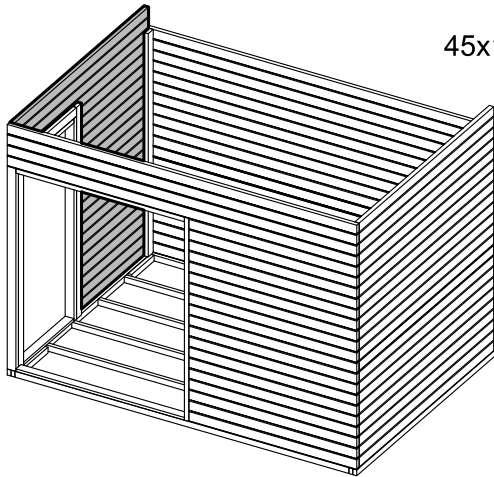
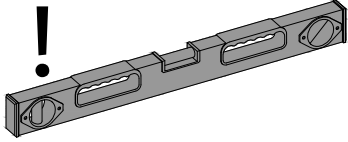

Vorbohren wird empfohlen.

WAND MONTAGE

SCHRAUBE 4.5x70 mm S1

SCHRAUBE 6.0x180 mm S3

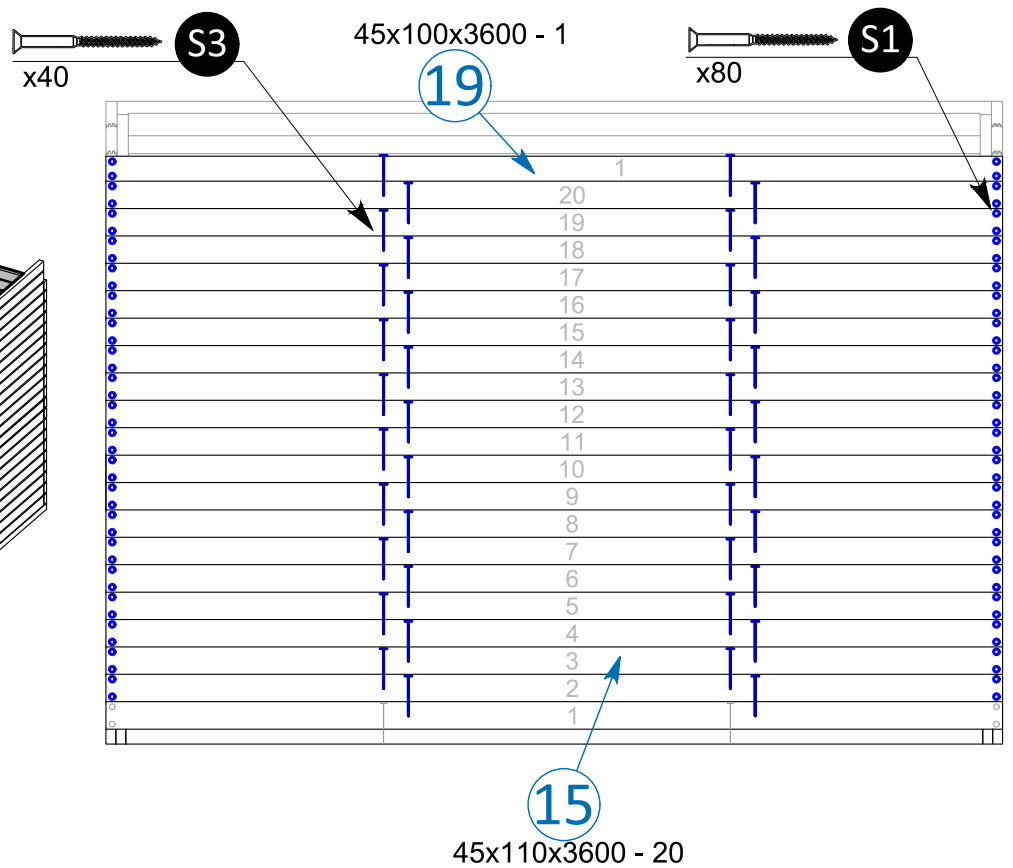
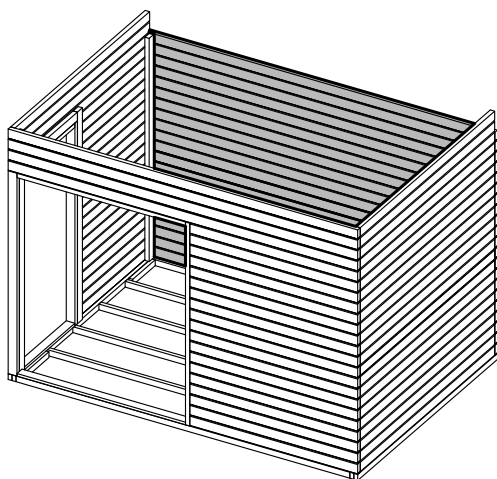
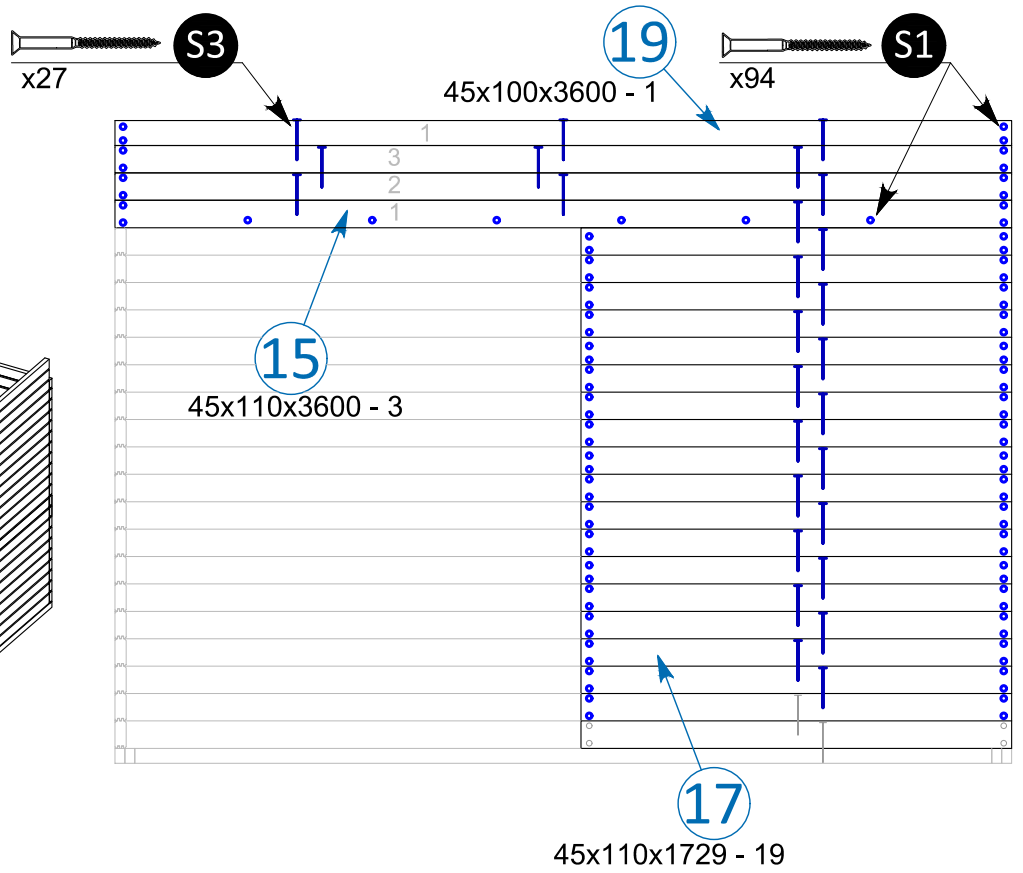
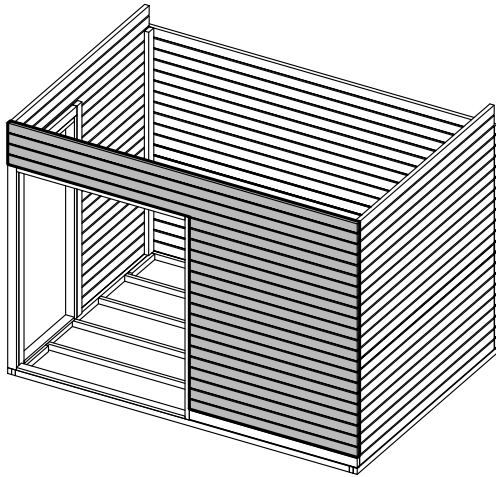
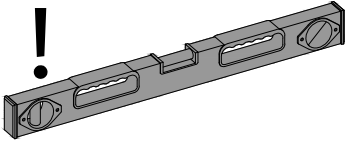

Vorbohren wird empfohlen.

DACHSPARREN - MONTAGE

SCHRAUBE
4.0x40 mm S4

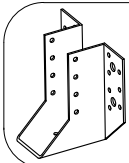

x6

45x145x3510 - 3

21

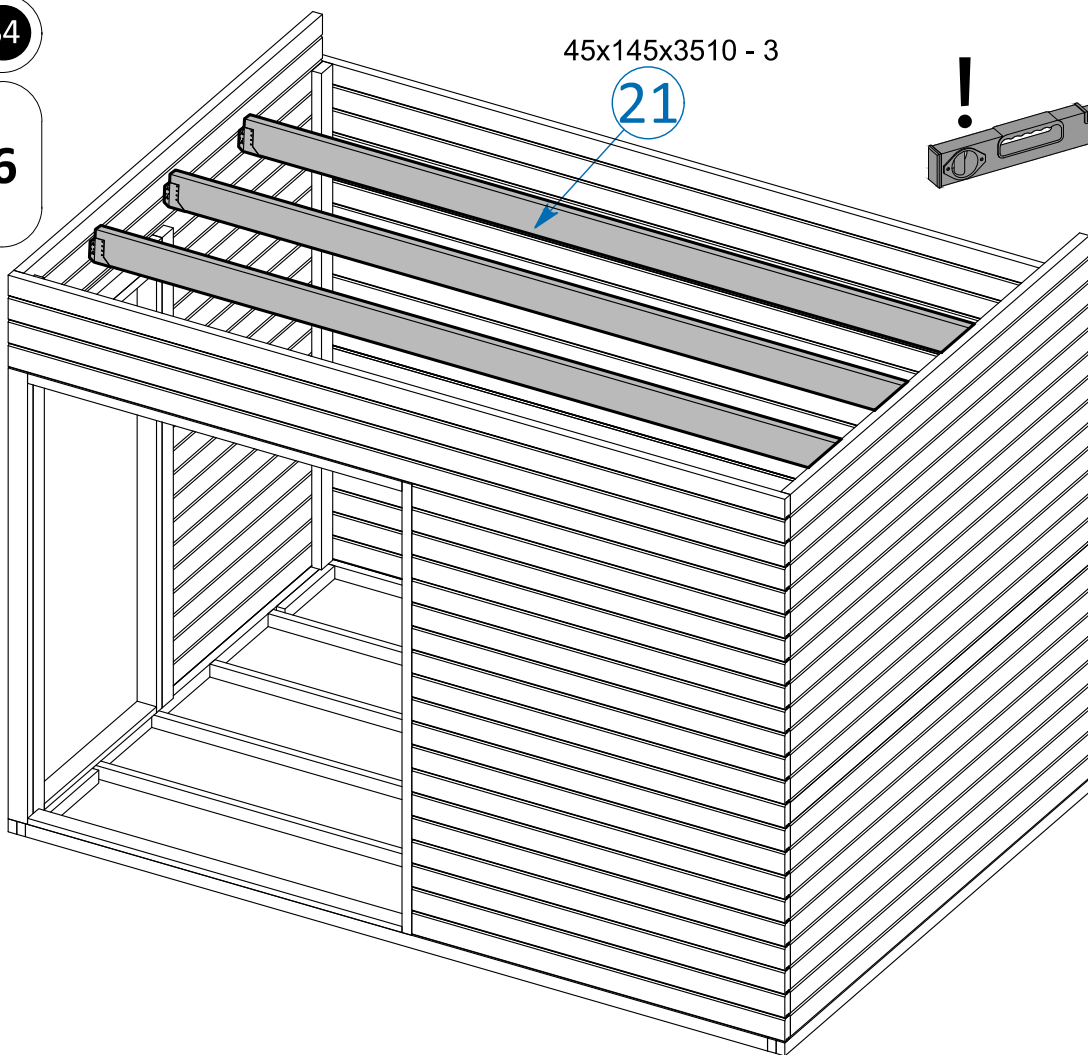
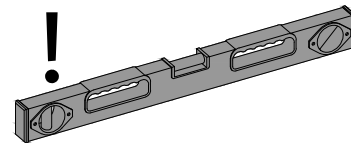

		21	3510	3	DACHSPARREN
--	--	----	------	---	-------------

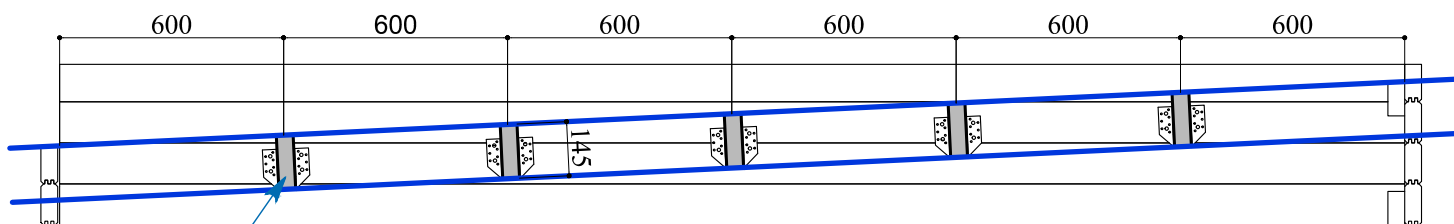

21

S4
x4+4

21

S4
x6+6

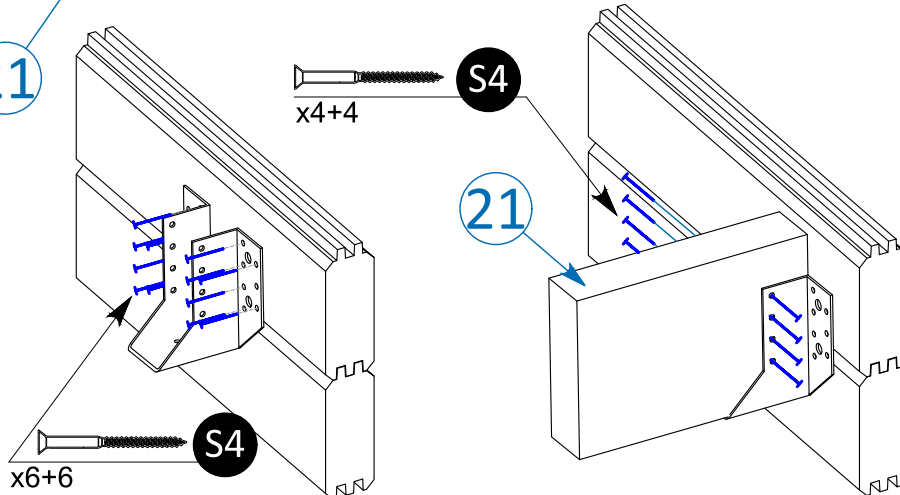

Vorbohren wird empfohlen.

DACH - MONTAGE

NAGEL
Lx40 mm

N1

SCHRAUBE
4.5x70 mm

S1

SCHRAUBE
4.0x40 mm

S4

~3-4 mm

22

19x96x2540 - 40

x5x40

N1

22

23 24

28x28x1755 - 2
19x98x1755 - 2

S1
2+2

S4
x8+8

23

24





23

24

25

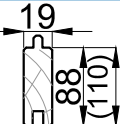
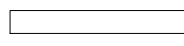
45x45x220 - 2

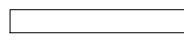
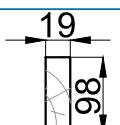
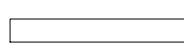
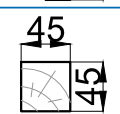
DACH ZUBEHÖR

		22	2540	40+1 (32+1)	DACHBRETT	
		23	1755	2	WINDBRETT LEISTE	
		24	1755	2	WINDBRETT	
		25	220	2	DACHBRETT LEISTE	

Vorbohren wird empfohlen.

WINDBRETT - MONTAGE

SCHRAUBE S1
4.5x70 mm

40x120x3750 - 1

40x120x2520 - 2

SCHRAUBE S4
4.0x40 mm

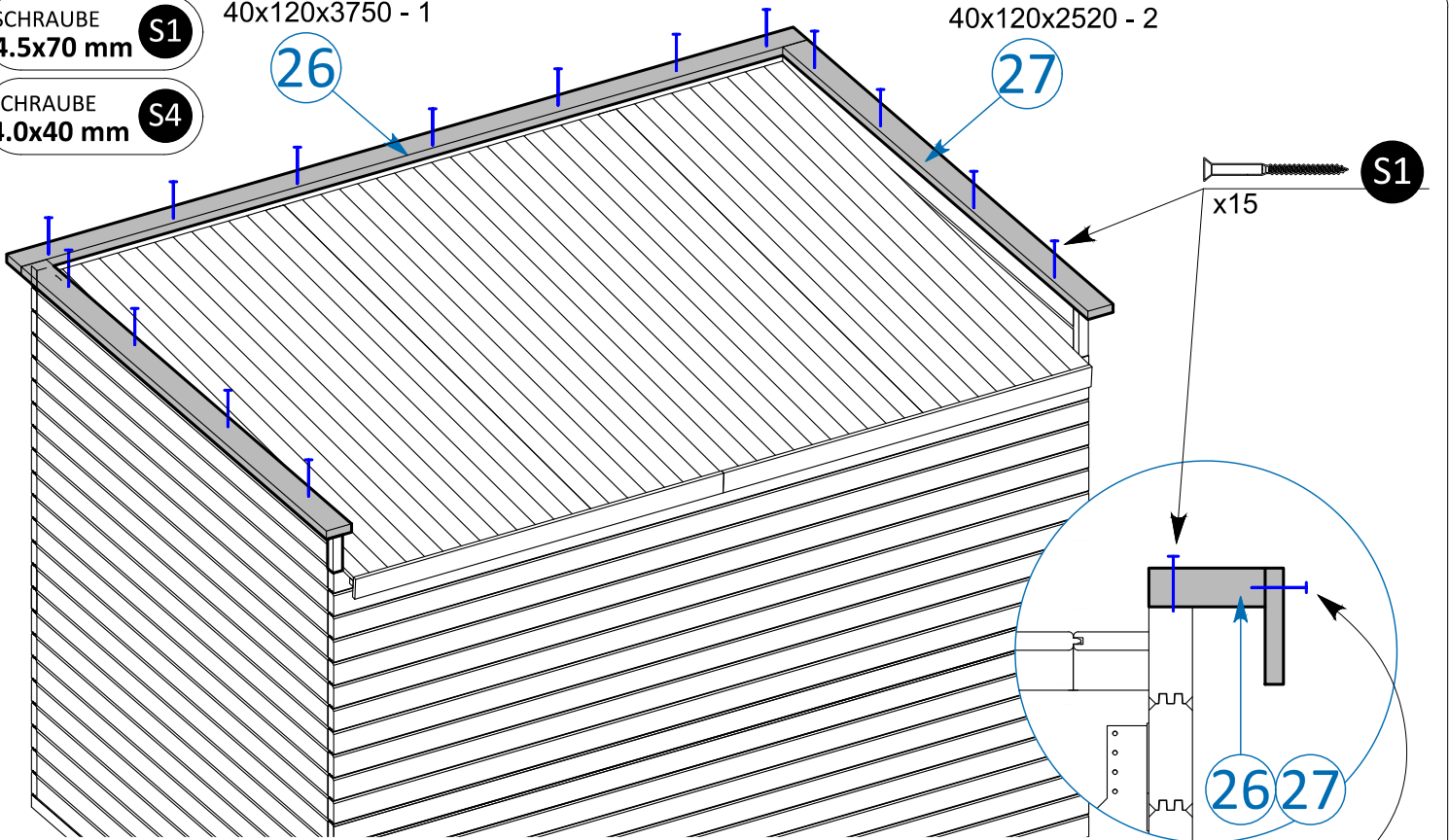

		26	3750	1	WINDBRETT	
		27	2520	2	WINDBRETT	

19x120x3788 - 1

28

S4
x13

19x120x2640 - 2

29

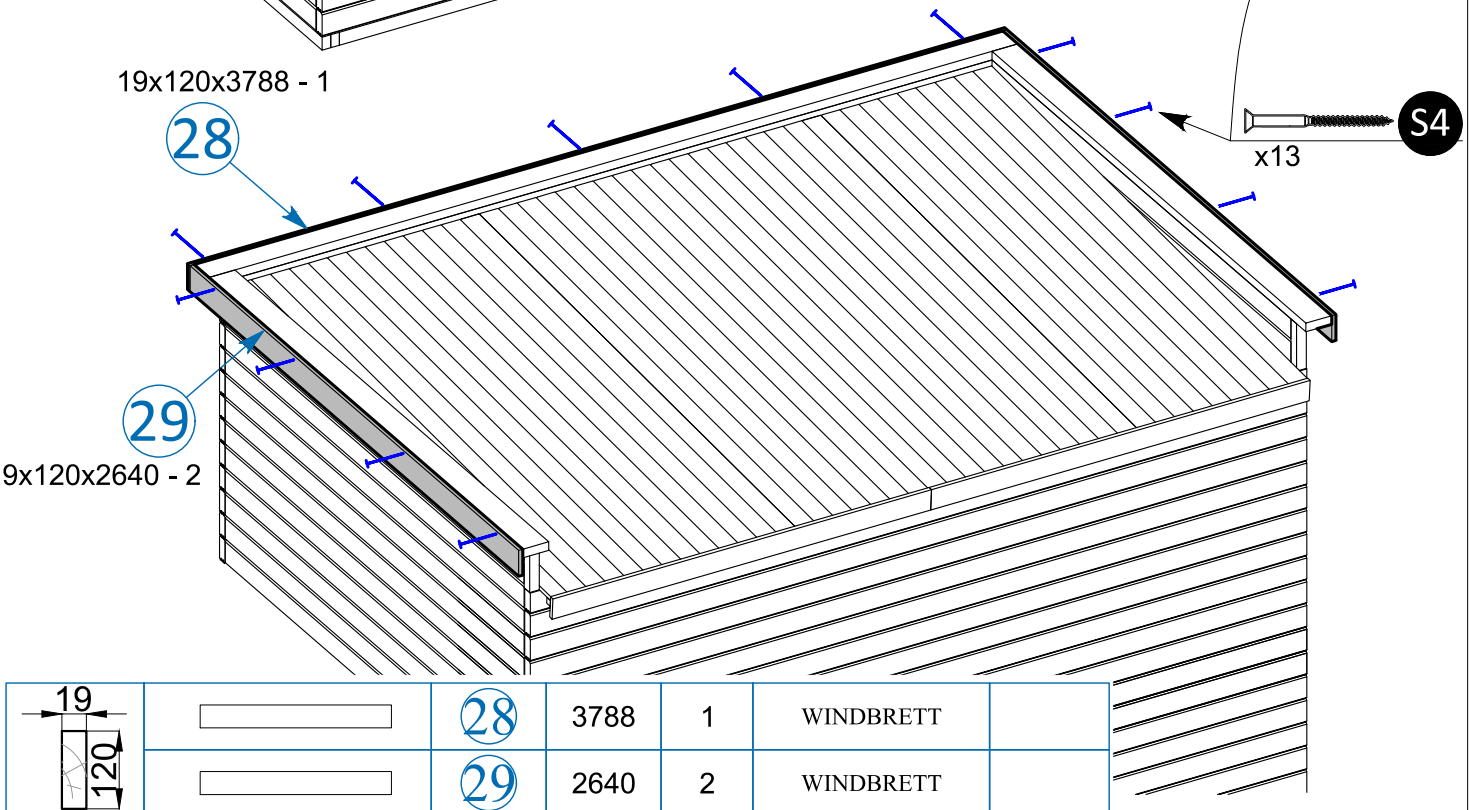

		28	3788	1	WINDBRETT	
		29	2640	2	WINDBRETT	

Vorbohren wird empfohlen.

BODEN MONTAGE

NAGEL
Lx50 mm

N2

SCHRAUBE
4.0x40 mm

S4

SCHRAUBE
4.5x70 mm

S1

45x90x1549 - 1

x3 S1

N2 x6x40

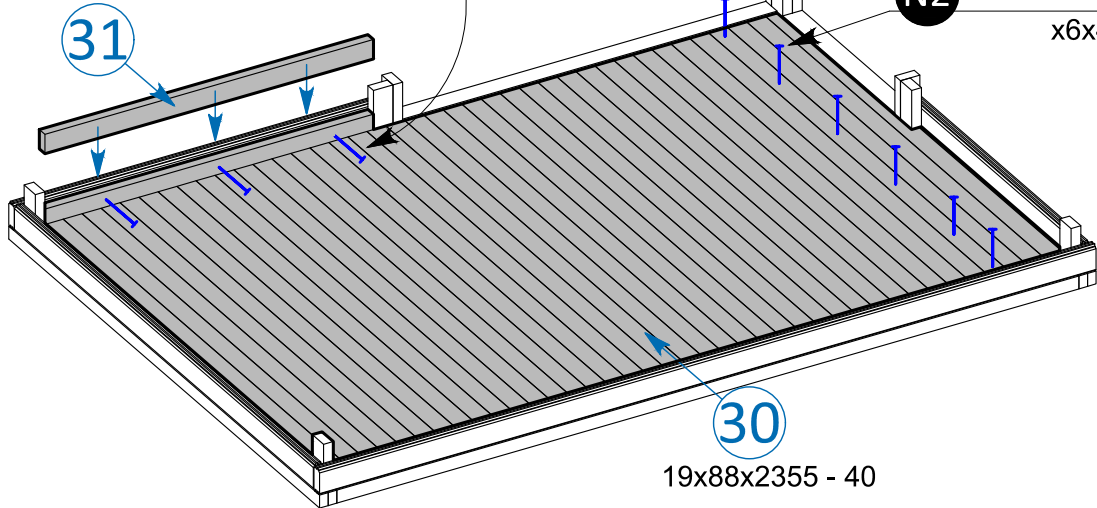

BODEN ZUBEHÖR

		30	2355	40+1 (32+1)
		31	1549	1
		32	3420	1
		33	2255	1
		34	1190	1
		35	1640	1

35 25x30x1640 - 1

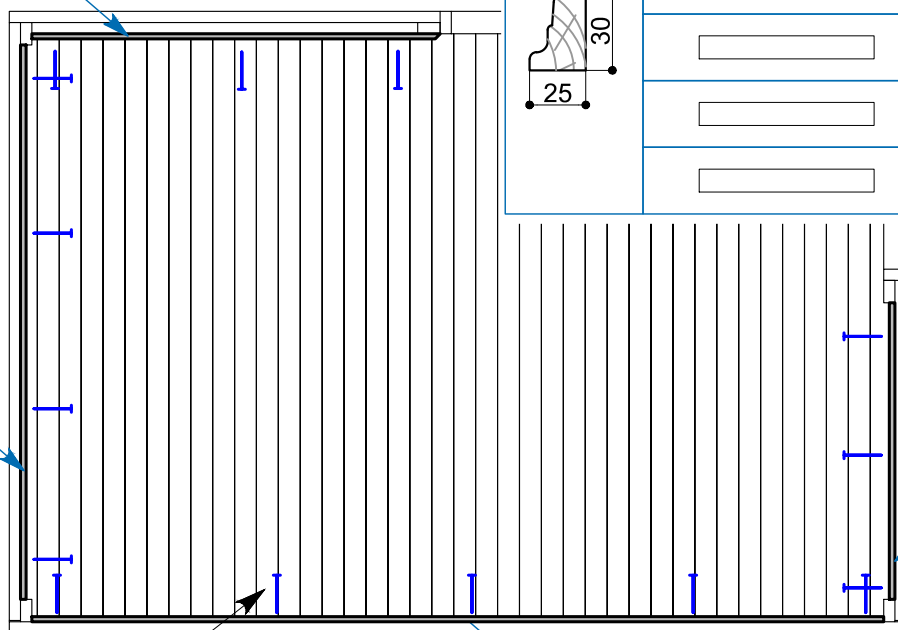

25x30x2255 - 1

25x30x1190 - 1

x15 S4

25x30x3420 - 1

Vorbohren wird empfohlen.

SCHIEBETÜRSYSTEM MONTAGE

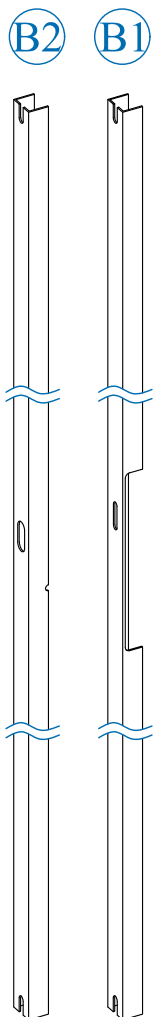
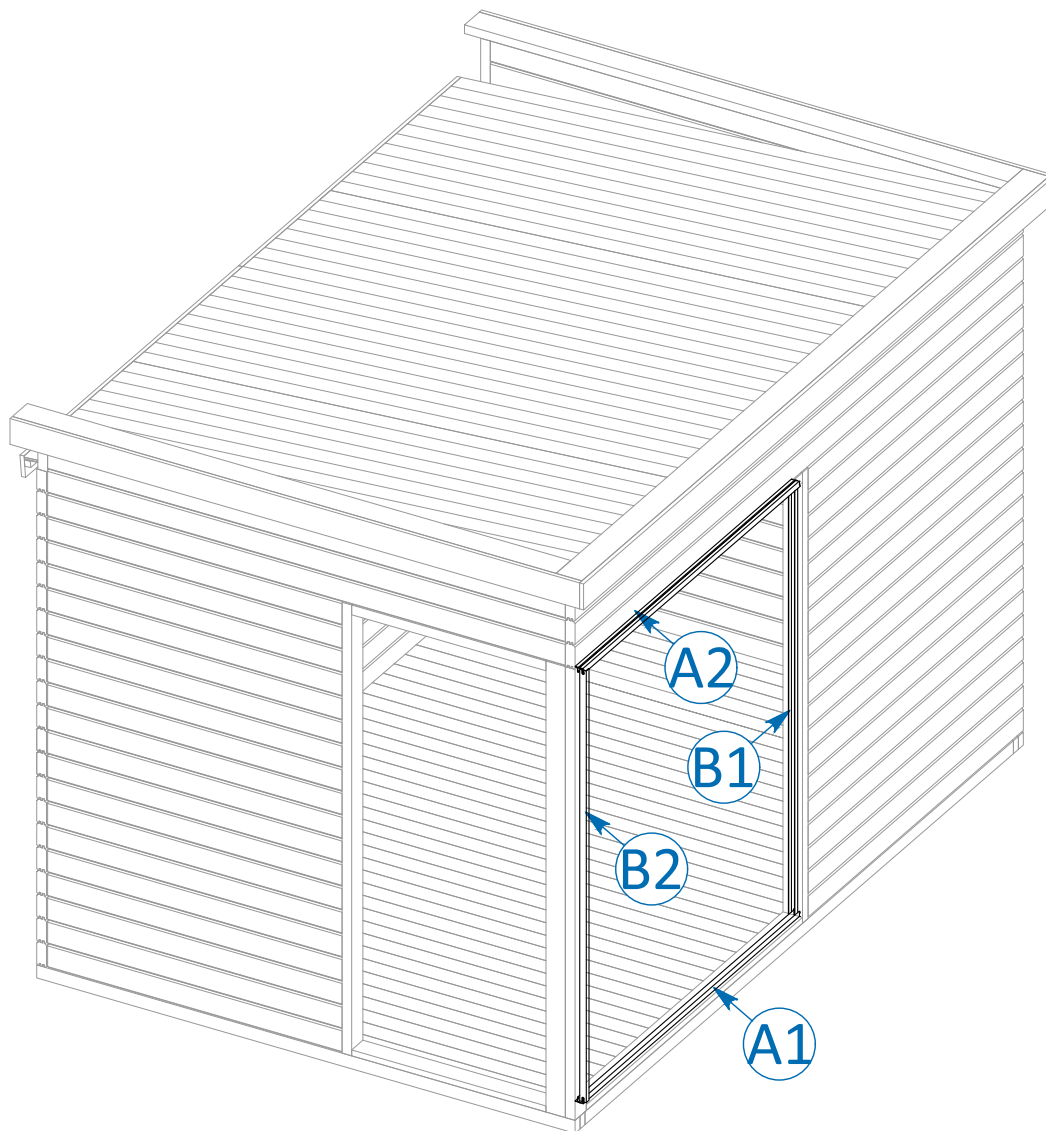

SCHIEBETÜRSYSTEM ZUBEHÖR

		A1	1736	1	UNTERE SCHIENE	
		A2	1736	1	OBERE SCHIENE	
		B1	2000	1	SEITENPROFIL	
		B2	2000	1	SEITENPROFIL	

Wir empfehlen auch die Verwendung von Dichtungsmaterial zwischen Profilen und Oberfläche, um zu verhindern, dass Regen in das Haus eindringt.

Vorbohren wird empfohlen.

SCHIEBETÜRSYSTEM MONTAGE -1-

SCHRAUBE 4.0x40 mm S4

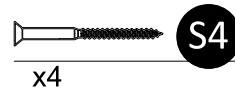
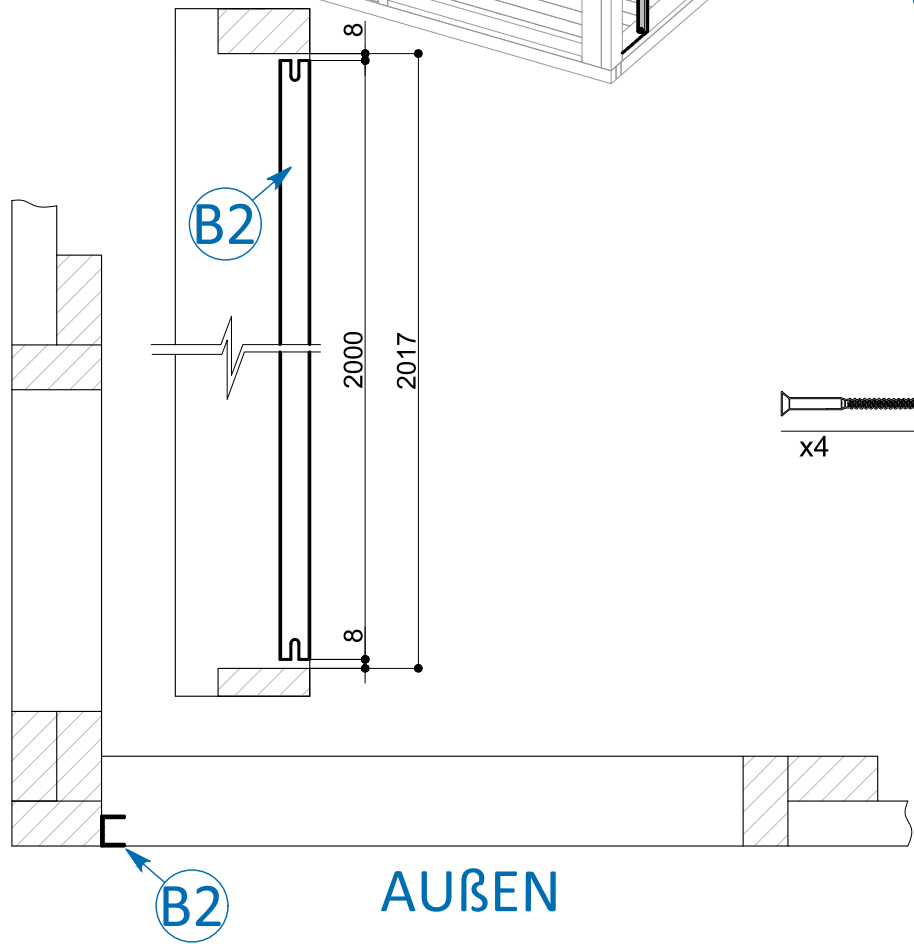
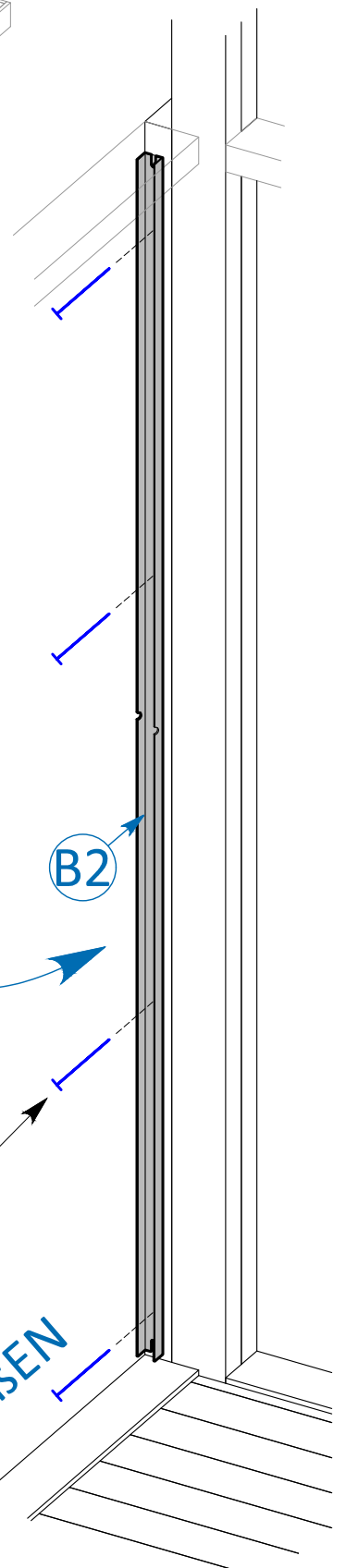
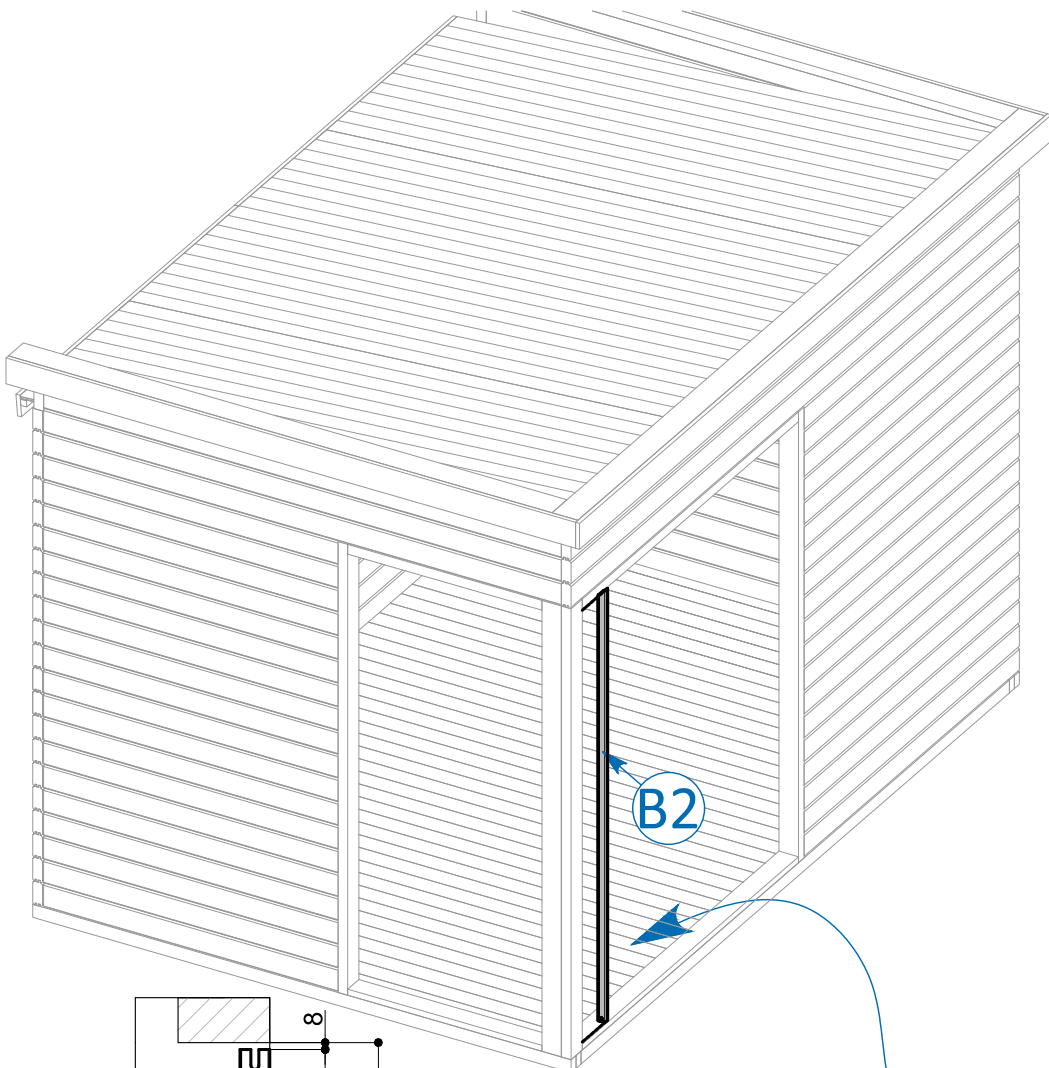

Vorbohren wird empfohlen.

SCHIEBETÜRSYSTEM MONTAGE -2-

SCHRAUBE
4.0x40 mm S4

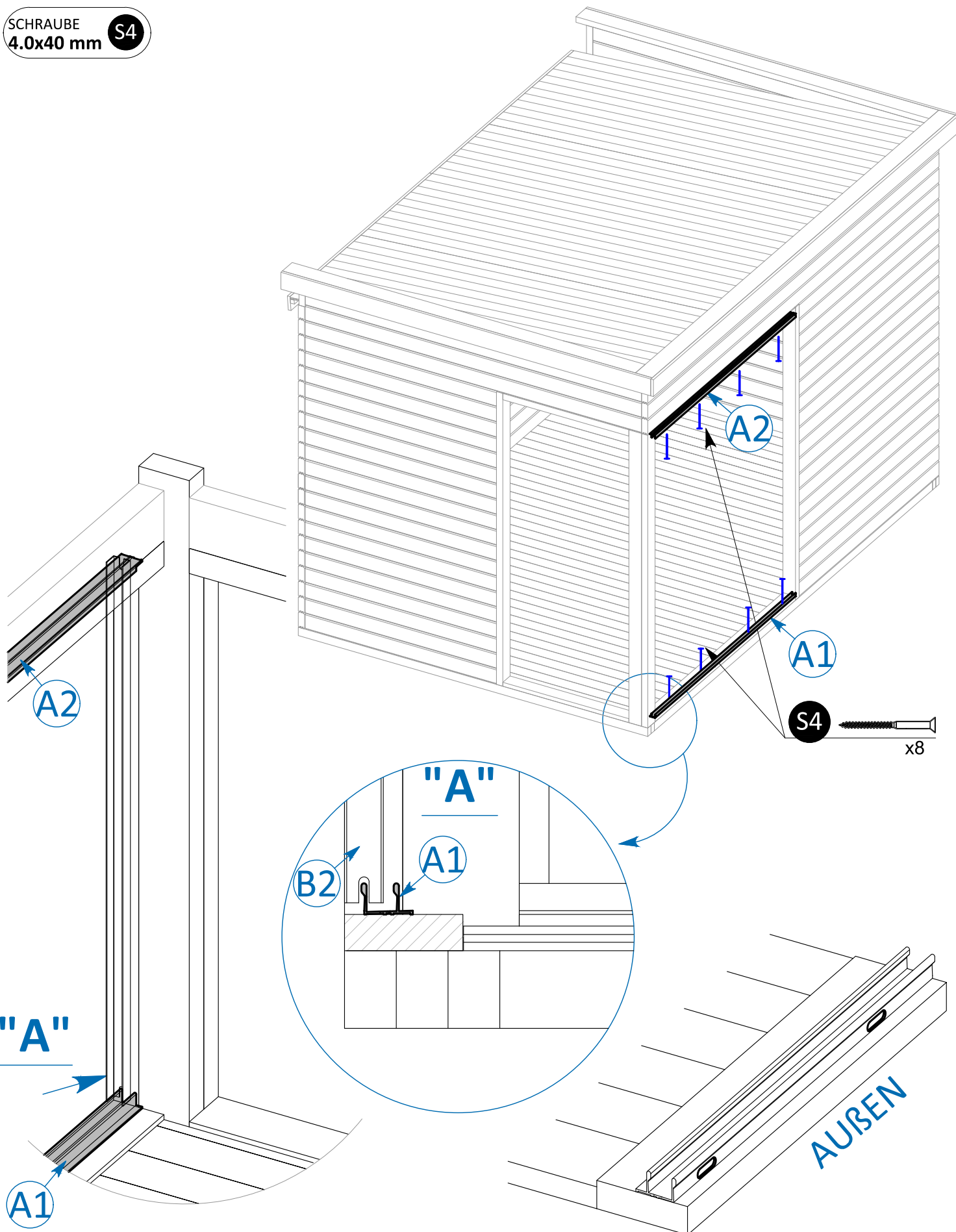

Vorbohren wird empfohlen.

SCHIEBETÜRSYSTEM MONTAGE -3-

SCHRAUBE
4.0x40 mm S4

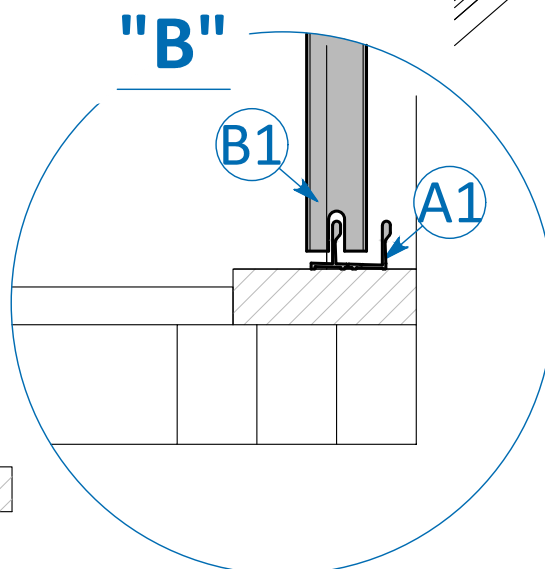
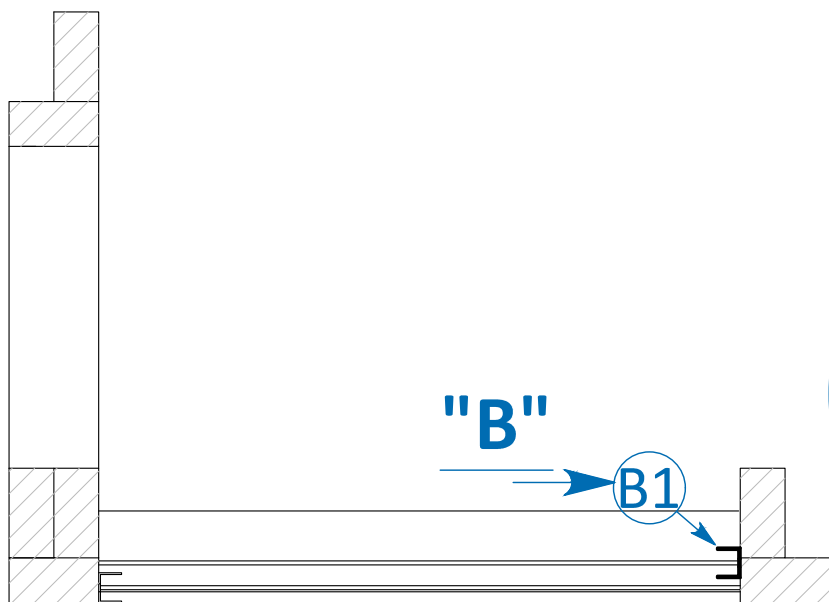
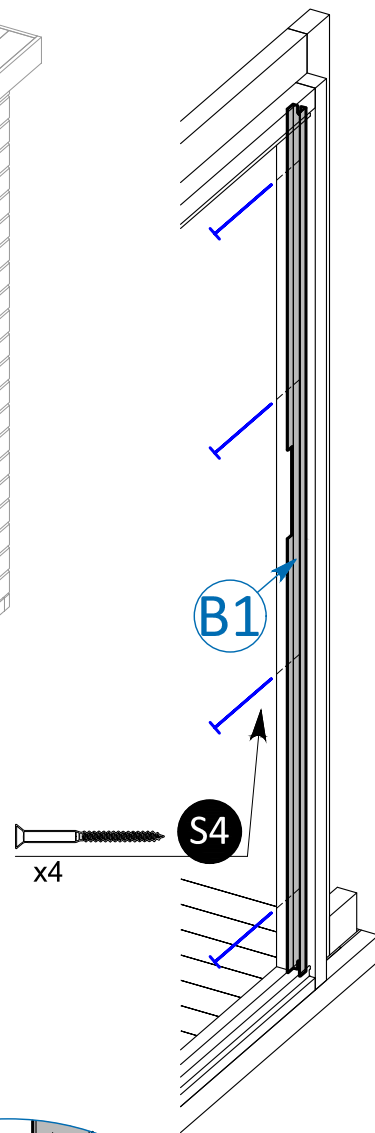
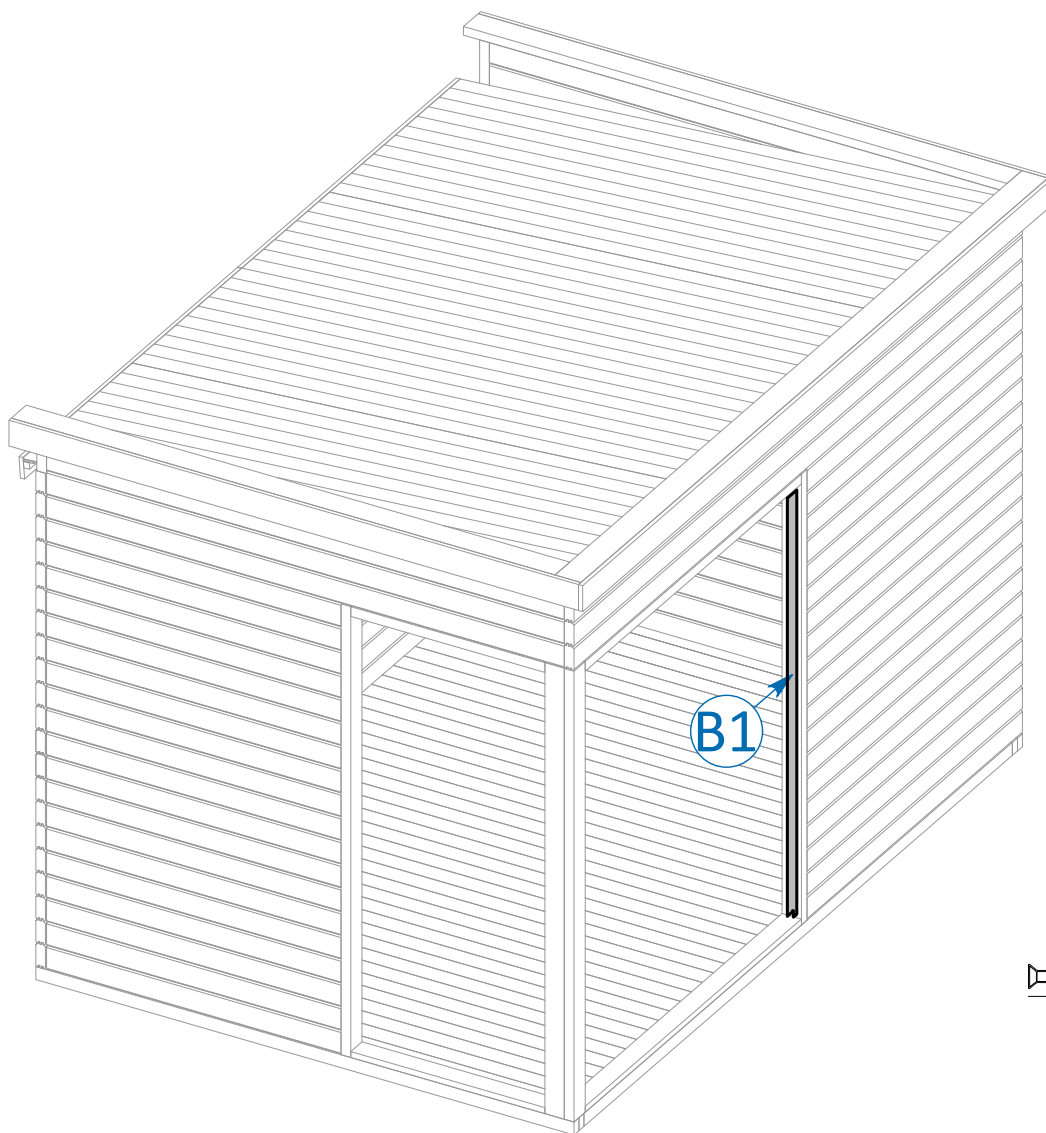

Vorbohren wird empfohlen.

SCHIEBETÜRSYSTEM MONTAGE -4-

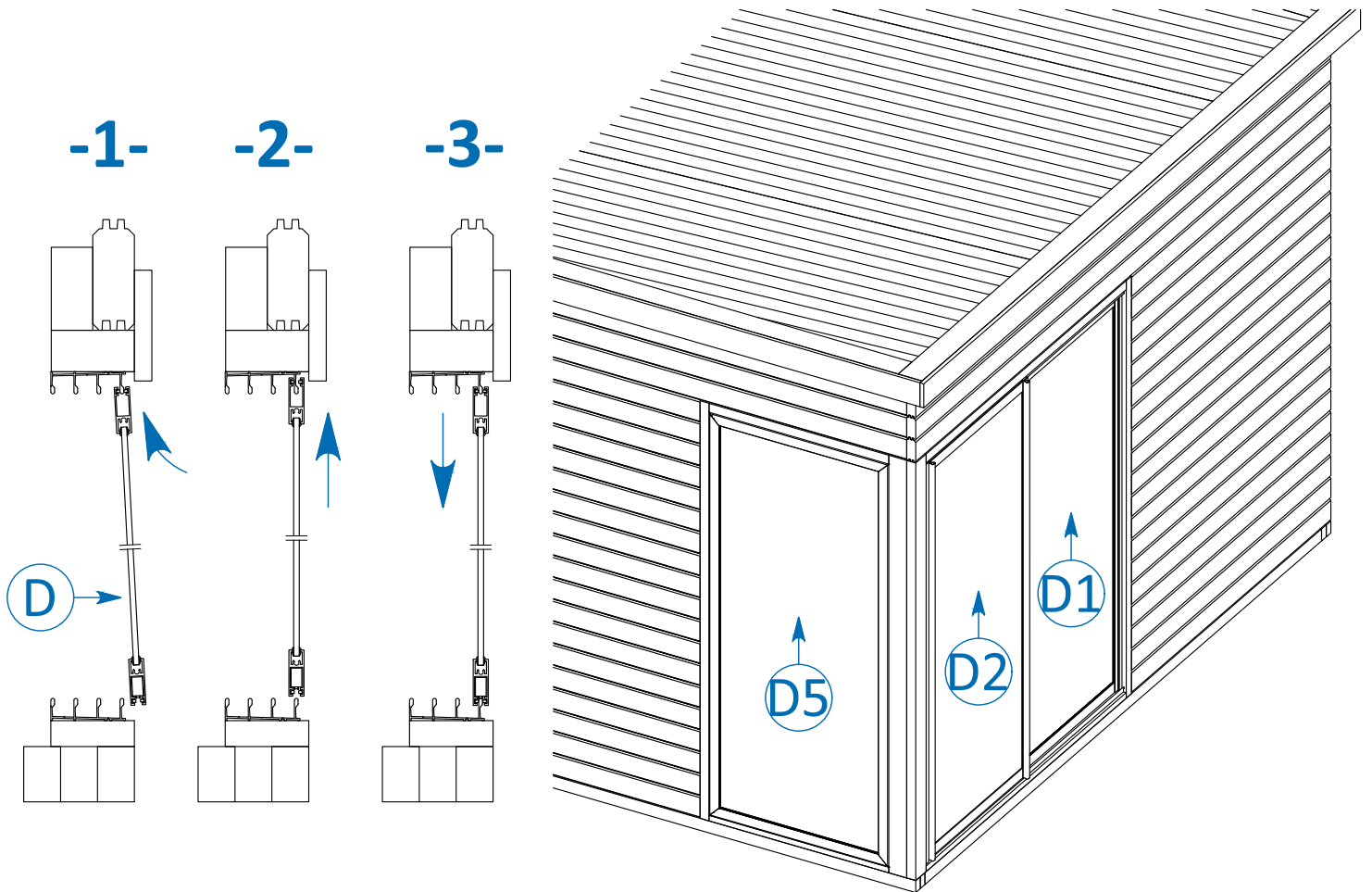

GLASSCHIEBETÜR ZUBEHÖR

	D1	.	1	GLASSCHIEBETÜR	
	D2	.	1	GLASSCHIEBETÜR	
	D5	900x2017	1	GLASSCHIEBETÜR	

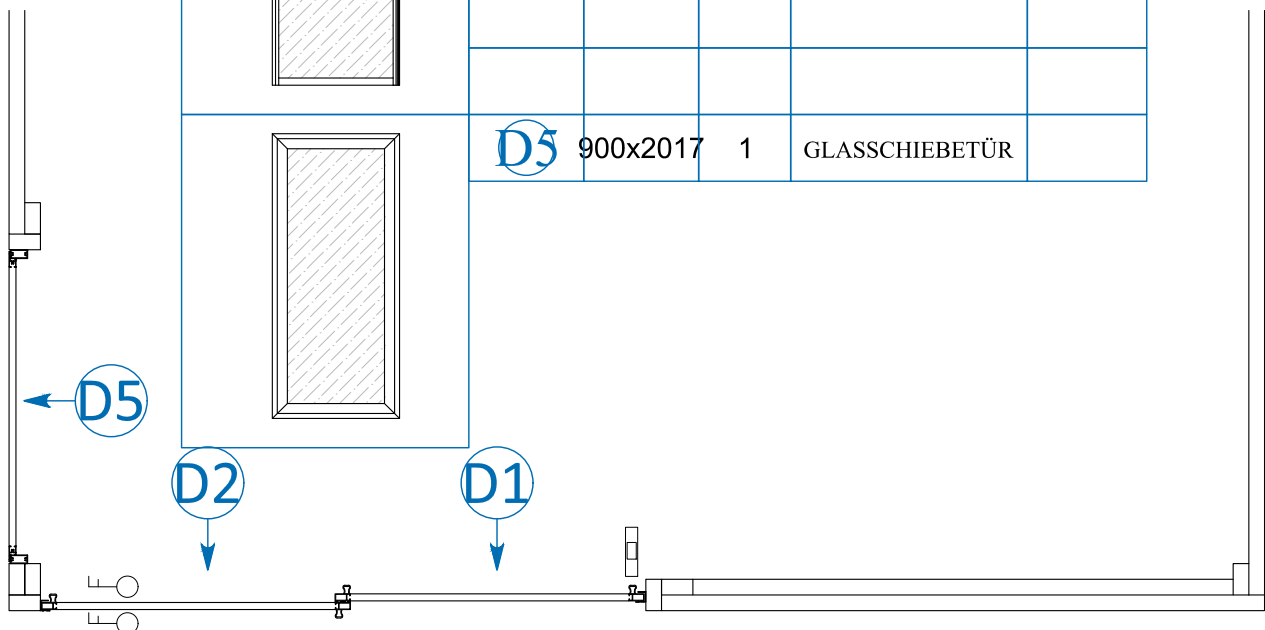

28/30

→||←45mm

2,4 x 3,6

45203

SCHIEBETÜRSYSTEM MONTAGE -5-

SCHRAUBE
4.0x40 mm S4

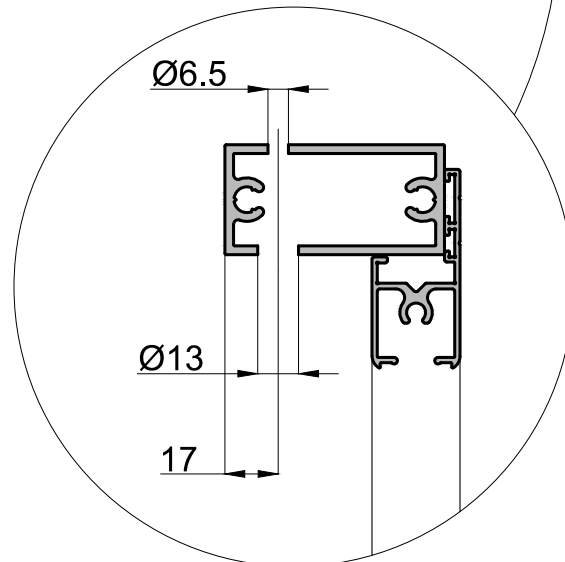
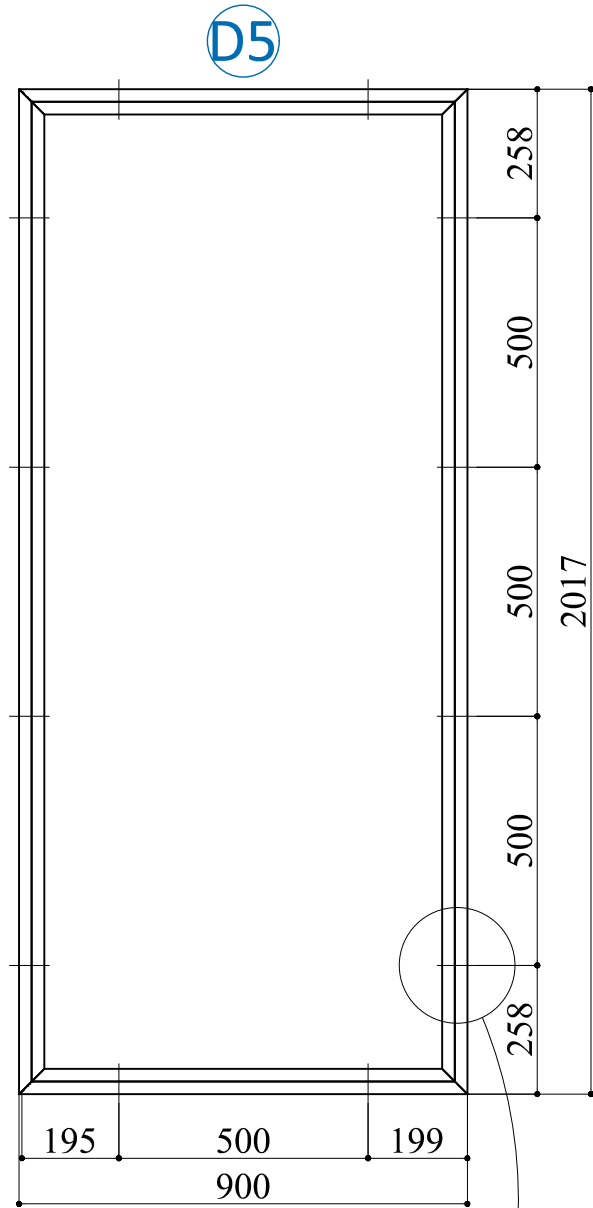
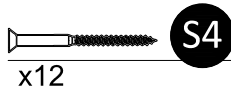
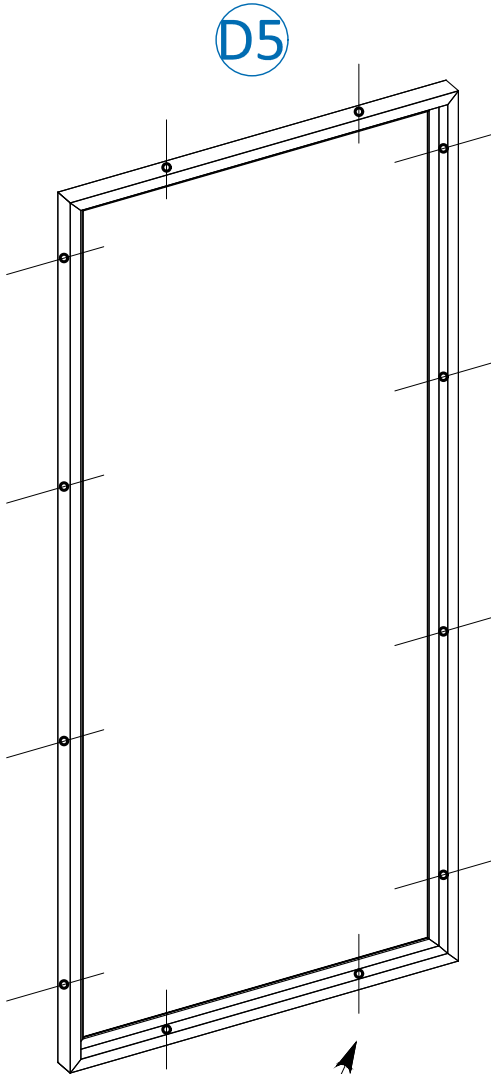

SCHRAUBE
4.0x40 mm S4

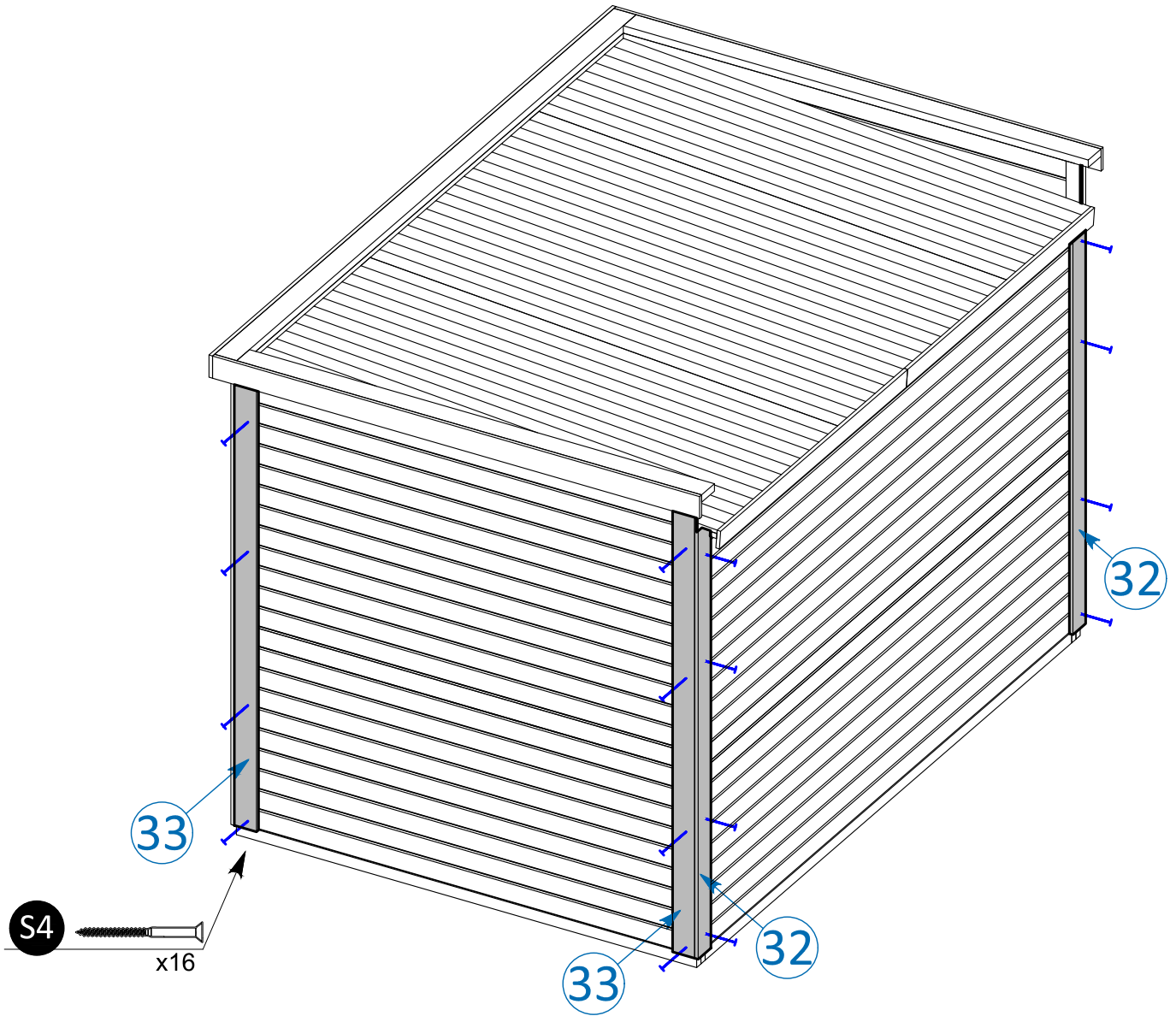

RAHMENBLENDEN ZUBEHÖR

		32	2300	2	RAHMENBLENDE	
		33	2520	8	RAHMENBLENDE	
		34	2035	2	RAHMENBLENDE	
		35	1020	1	RAHMENBLENDE	
		36	1880	1	RAHMENBLENDE	
		37	2035	1	RAHMENBLENDE	

Vorbohren wird empfohlen.

RAHMENBLENDEN MONTAGE

SCHRAUBE
4.0x40 mm S4