

Möbelkollektion **PRANA**

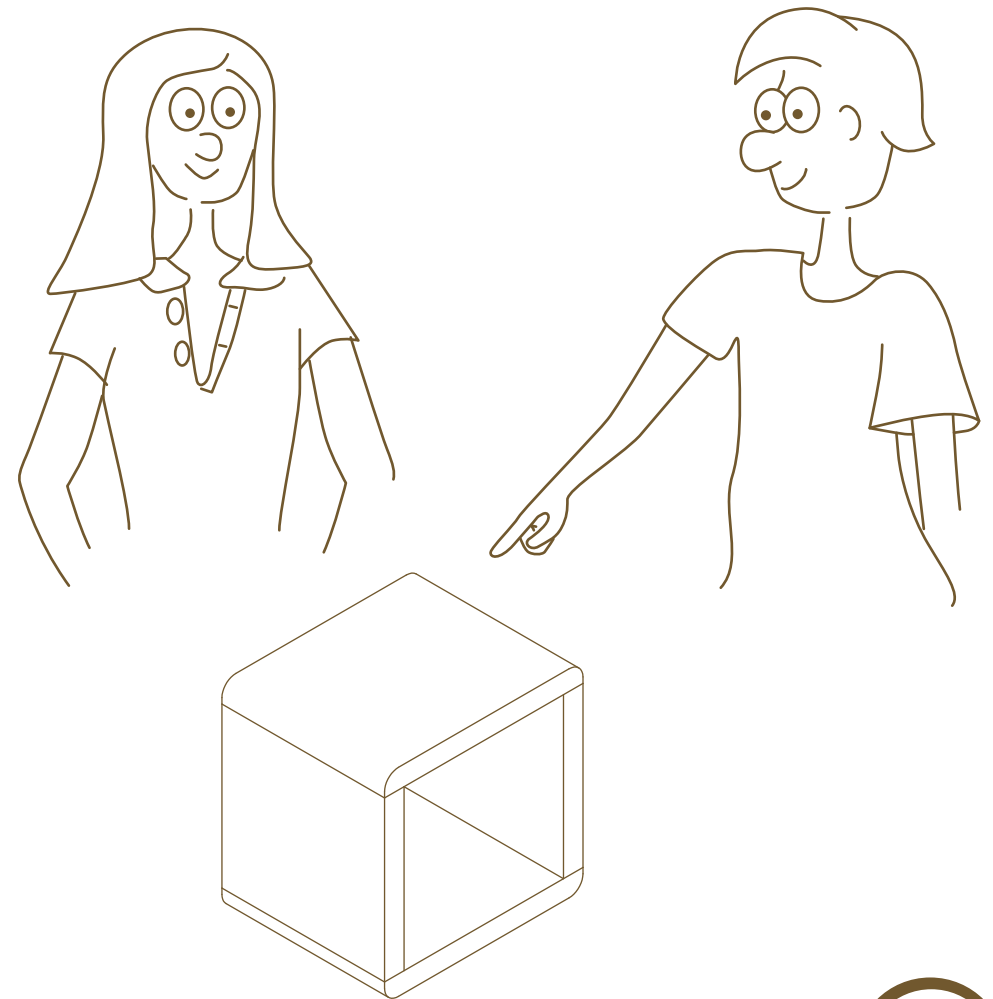

Artikel: 11 88 08
Maße: 43 x 43 x 35 cm

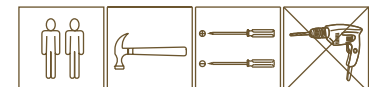

®

Für den Würfel brauche ich einen Kreuzschlitz- und einen Schlitzschraubendreher

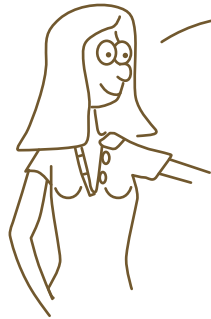
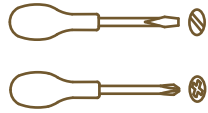

Joe, damit der Würfel nicht kaputt geht, brauchst Du eine weiche Unterlage, wie einen Teppich oder Karton.

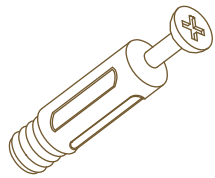
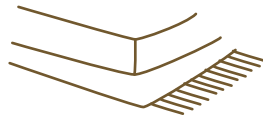

a | 8x

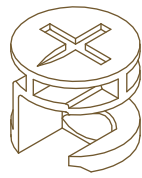

b | 8x



c | 4x

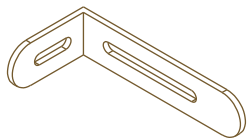

d | 1x

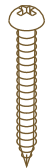

e | 1x



f | 1x



g | 1x

QUALITY:



RESISTANCE:

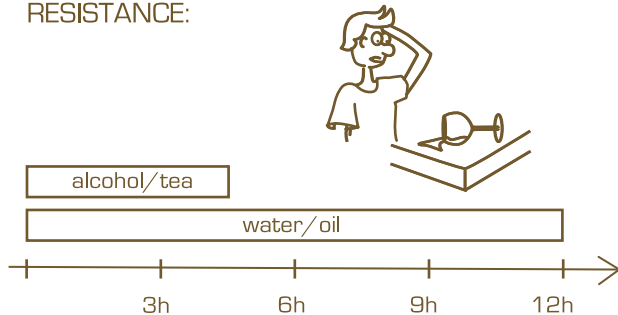

RESPONSIBILITY:



INFO:



+41 41 780 38 08



info@phoenix-group.ch



www.phoenix-home.info



www.phoenix-home.info

10

PH01 001-18

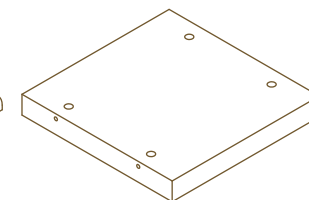
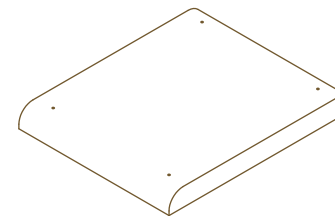
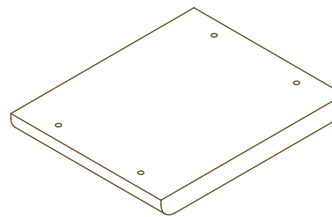

A | x2

B | x2

1

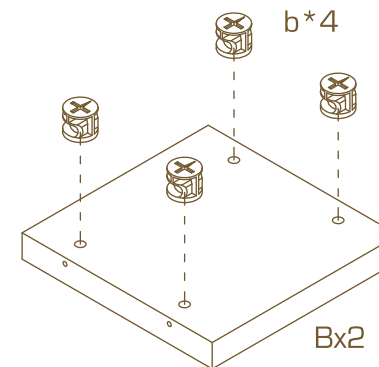
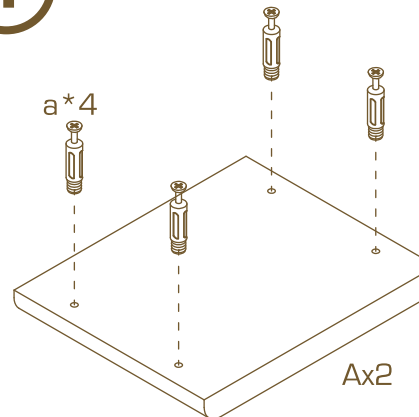

2

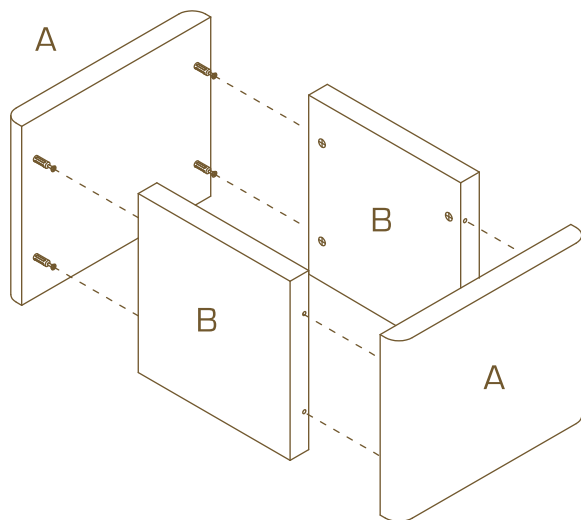

DEUTSCH

Fachkundige Montage erforderlich. Unsachgemäße Montage kann zu Unfällen führen; Möbel/Gegenstand könnte kippen oder umfallen. **WICHTIG!** Schrauben oder Beschläge zur Wand-/Deckenbefestigung sind nicht beige packt. Achten Sie darauf, dass Sie Schrauben/Beschläge entsprechend der Wand-/Deckenbeschaffenheit und mit ausreichender Tragfähigkeit verwenden. Erkundigen Sie sich ggfs. beim Eisenwarenfachhandel.

ENGLISH

The assembly should be carried out by a qualified person due to the fact that wrong assembly can lead to that the furniture/object topples or falls resulting in personal injury or damage.

NOTE! Screws or fittings to fix the furniture/object to the wall/ceiling are not included. Always choose screws and fittings that are specially suited to the material in your wall/ceiling and have sufficient holding power. If you are uncertain, contact your local specialised retailer.

FRANÇAIS

Le montage doit être effectué par une personne compétente. Un montage mal effectué peut provoquer la chute du meuble/de l'objet et blesser quelqu'un. **ATTENTION!** Les vis et ferrures pour fixer le meuble/l'objet au mur ou au plafond ne sont pas incluses. Adaptez les vis et ferrures au matériau du mur/plafond et au poids de l'objet. En cas de doute, demandez conseil à un vendeur spécialisé.

NEDERLANDS

De montage dient te worden uitgevoerd door een vakbekwaam iemand. Foutieve montage kan er toe leiden dat het meubel/voorwerp kantelt of omvalt; en iets beschadigt resp. iemand bezeert. N.B. Schroeven of beslag om het meubel/voorwerp in de wand/het plafond vast te zetten, zijn niet inbegrepen. Denk er aan dat de schroeven of het beslag dat je kiest geschikt moeten zijn voor de wand/het plafond waarin ze vastgezet moeten worden, en voldoende draagkracht moeten hebben. Neem bij twijfel contact op met de lokale vakhandel.

ITALIANO

Il montaggio deve essere effettuato da una persona competente. Se non viene effettuato correttamente, il prodotto può ribaltarsi o cadere, danneggiando persone o cose. N.B. Le viti e gli accessori per fissare il prodotto alla parete/al soffitto non sono inclusi. Scegli viti e accessori di fissaggio in grado di sostenere il peso del prodotto in questione e adatti alla parete/al soffitto a cui l'articolo va fissato. Se hai dei dubbi, rivolgiti a un rivenditore specializzato.

ESPAÑOL

El montaje lo debe realizar una persona experta, pues si no se procede correctamente el mueble/elemento se puede caer y causar daños a personas u objetos. **¡ATENCIÓN!** No se incluyen los tornillos o herrajes para sujetar el mueble/elemento en la pared/el techo. Recuerda que los tornillos o herrajes que elijas deben ser los adecuados para la pared/el techo en donde irán sujetos, y que tenga la resistencia suficiente. Si no estás seguro, ponte en contacto con tu tienda especializada.

PORTUGUES

O móvel deve ser montado por uma pessoa especializada, porque se não for montado correctamente, pode cair e causar danos. **ATENÇÃO!** Os parafusos e ferragens para fixar o móvel à parede/tecto não estão incluídos. Escolha sempre os parafusos e ferragens apropriados para o material da sua parede/tecto e que tenham a suficiente capacidade de suporte. Se tiver dúvidas, contacte com um especialista.

SVENSKA

Monteringen ska utföras av kunnig person, då felmontering kan leda till att möbelen/föremålet tippar eller faller och skadar någon eller något. **OBS!** Skruvar eller fästbeslag att fästa möbelen/föremålet i väggen/taket medföljer ej. Tänk på att skruvarna eller fästbeslagen du väljer ska vara avsedda för väggen/taket de ska fästa i, samt ha tillräcklig bäarkraft. Är du osäker kontakta din lokala fackhandel.

DANSK

Monteringen skal udføres af en kyndig person, da fejlmontering kan føre til at møblet/genstanden tipper eller falder ned og skader nogen eller noget. **OBS!** Skruer eller beslag til at sætte møblet/genstanden fast i væggen medfølger ikke. Husk på at skruerne eller beslagene du vælger skal være beregnet til væggen/loftet de skal skrues fast i, samt ha tilstrækkelig bærekraft. Er du usikker, kontakt da din lokale fagmand.

NORSK

Monteringen skal utføres av en kyndig person, da feilmontering kan føre til at møbelet/objektet kan tippe eller falle og skade noe eller noen. **OBS!** Skruer eller festebeslag til å feste møbelet/objektet til veggen/taket medfølger ikke med. Pass på at du velger skruer/festebeslag som er beregnet på det materialet de skal festes i, samt at de har tilstrekkelig bærekraft. Kontakt din lokale faghandel dersom du er i tvil.

SUOMI

Asennuksenvoi tehdä asiantunteva henkilö, koska virheellinen asennus voi saada aikaan, että huonekalu/elemento se puede caer y causar daños a personas u objetos. **HUOM!** Ruuveja tai kiinnikkeitä, joilla kiinnittää huonekalu/esine seinään/kattoon ei ole mukana. Huomioi, että ruuvit tai kiinnikkeet sopivat siihen seinään/kattoon, johon olet kiinnittämässä ja , että niillä on tarpeeksi suuri kantavuus. Jos olet epävarma, ota yhteyttä paikalliseen ammattilikkeeseen.

POLSKI

Montaż powinien być przeprowadzony przez osobę odpowiedzialną wykwalifikowaną. W przeciwnym razie źle zmontowany mebel/ obiekt może się przewrócić lub rozpaść wyrządzając krzywdę właścicielowi. **UWAGA!** Komplet nie zawiera wkrętów ani zamocowań potrzebnych do przymocowania mebla/ obiektu do ściany/sufitu. Zawsze wybierz wkręty i zamocowania odpowiednio do twojej ściany/sufitu i odpowiedzialnie wytrzymałe. W przypadku jakichkolwiek wątpliwości należy kontaktować się z lokalnym sprzedawcą.

ČESKY

Montáž by měl provést kvalifikovaný odborník. Špatná montáž může způsobit převážení nebo pád nábytku/věci a způsobit tak zranění či škody. **UPozORNĚNÍ!** Šrouby nebo kování, které jsou nutné k připevnění nábytku/věci ke stěně/stropu, nejsou součástí balení. Použijte pouze šrouby nebo kování, které jsou vhodné do dané stěny či stropu a mají dostatečnou nosnost. Nejste-li si jisti, obraťte se na speciální zovaný obchod.

SLOVENSKY

Montáž by mala vykonať kvalifikovaná osoba. Pri nesprávnej montáži môže dôjsť k pádu nábytku, a tým aj k pripadnému úrazu. **Upozornenie!** Skrutky alebo uchytenia nie sú súčasťou balenia. Vždy zvolte skrutky a úchytky vhodné pre daný materiál. Ak si nie ste istí, obráťte sa na kvalifikovanú osobu.

MAGYAR

Az összeszerelés lehetőleg hozzáértő személy végezze, mert a nem megfelelő, hibás össze-áll. felszerelés esetében a bútor feldőlhet, leszakadhat a falról, ezzel személyi sérülést vagy balesetet okozva. **FIGYELEM!** A bútor fali / mennyezeti rögzítéséhez szükséges csavarokat, Szerelvényeket külön kell megvásárolni Válasszon olyan csavart,tiplit mely Leginkább alkalmas az otthonában Található fal / mennyezet anyagához És teherbíró képessége is megfelelő. Ha bizonytalan vagy bármilyen kérdése merül fel forduljon szakképzett eladóinkhoz.

3

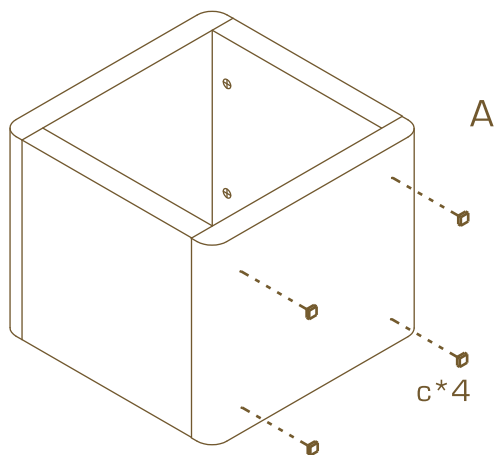

STOR IT - Die Zubehörserie zum „einfach | clever | einrichten“

Die pfiffige Accessoire-Kollektion 'STOR IT' umfasst viele trendige und praktische Accessoires, die perfekt auf unsere Möbelkollektionen 'EASY', 'SMART', 'CARO' und 'PRANA' abgestimmt sind. 'STOR IT' ist aus hochwertigem Canvasmaterial gefertigt und in vielen trendigen Farben & Mustern erhältlich. Dazu gibt es Tür-/ Schubladencontainer mit kratzfester Kunstharzbeschichtung oder Hochglanzlackierung.

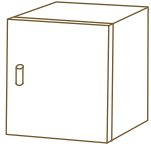

Türcontainer
34 x 34 x 34 cm
Art.-Nr.: 11 82 10



Schubladencontainer
34 x 34 x 34 cm
Art.-Nr.: 11 82 11

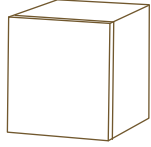

Türcontainer hochglanz
34 x 34 x 34 cm
Art.-Nr.: 11 88 10

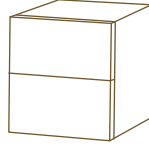

Schubladencontainer hochglanz
34 x 34 x 34 cm
Art.-Nr.: 11 88 11

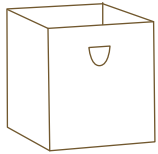

Canvasbox 2er Set
34 x 34 x 34 cm
Art.-Nr.: 81 73 01

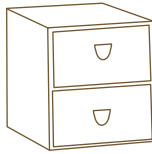

Aufbewahrungsbox mit
2 Schubladen
34 x 34 x 34 cm
Art.-Nr.: 81 73 15

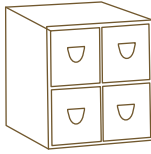

Aufbewahrungsbox mit
4 Schubladen
34 x 34 x 34 cm
Art.-Nr.: 81 73 02

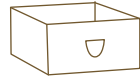

Canvasbox 2er Set,
klein
34 x 16 x 29 cm
Art.-Nr.: 81 73 14

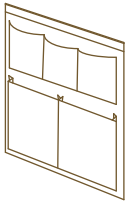

Organizer mit 5 Fächer
45 x 45 cm
Art.-Nr.: 81 73 21

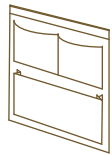

Organizer mit 3 Fächer
33 x 29 cm
Art.-Nr.: 81 73 22



Canvasbox 2er Set, lang
71 x 16 x 29 cm
Art.-Nr.: 81 73 13



Canvasbox 2er Set
10 x 34 x 25 cm
Art.-Nr.: 81 73 40

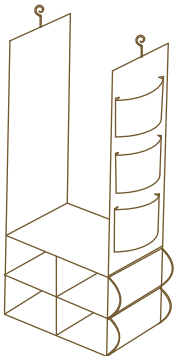

Schrankorganizer mit
Hemdenfach
129 x 45 x 34 cm
Art.-Nr.: 81 73 23

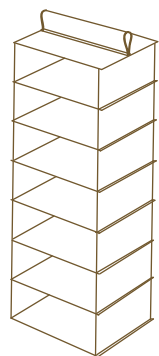

Schrankorganizer mit
7 Fächern
129 x 33 x 34 cm
Art.-Nr.: 81 73 24

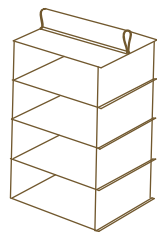

Schrankorganizer mit
4 Fächern
68 x 33 x 34 cm
Art.-Nr.: 81 73 25

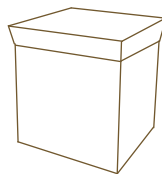

Sitzbox "SIT"
41 x 41 x 44 cm
Art.-Nr.: 81 73 30

4

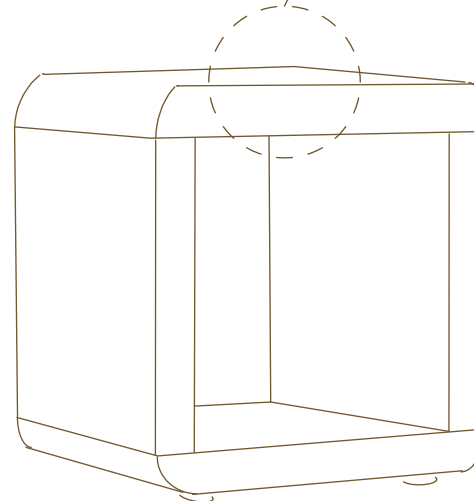
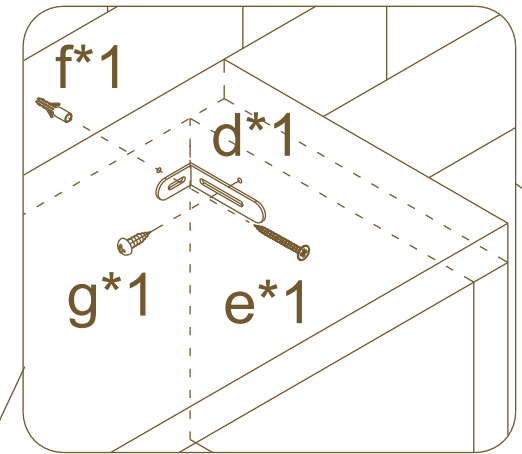
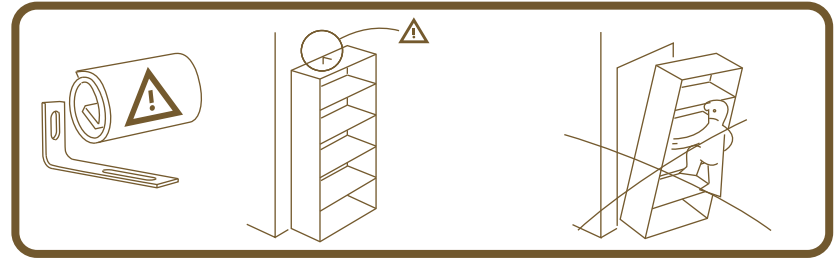

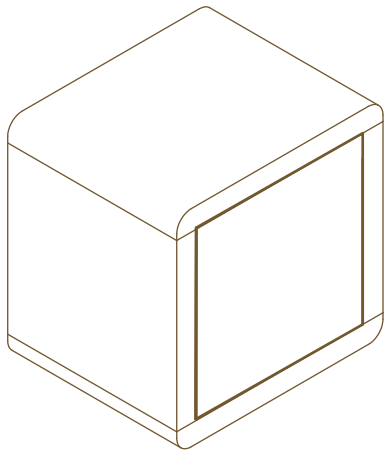

mit Türcontainer
34 x 34 x 34cm
Art.Nr. 11 88 10

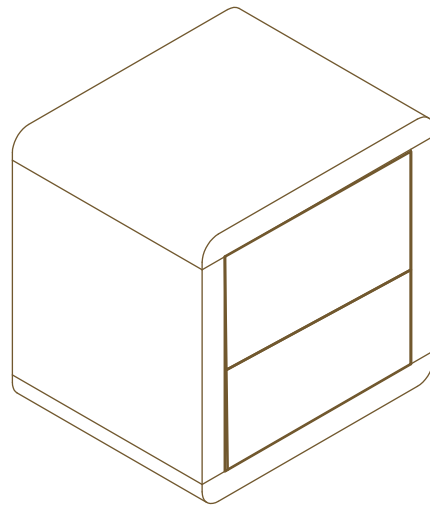

mit Schubladencontainer
34 x 34 x 34cm
Art.Nr. 11 88 11

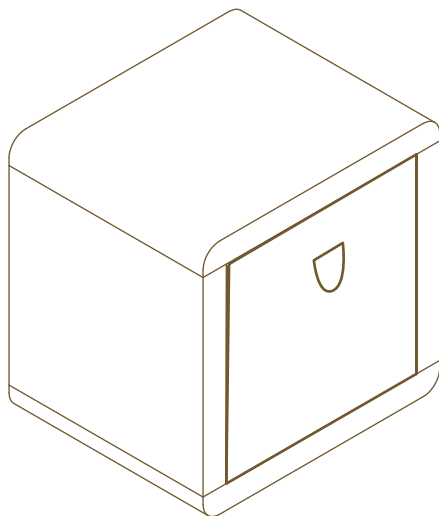

mit Canvas Box
34 x 34 x 34cm
Art.Nr. 81 73 01

PRANA

Bei dieser Serie werden unsere besten Materialien mit Funktionalität, Komfort und Farben kombiniert. Das besondere Designmerkmal von 'PRANA' ist der weisse Hochglanzrahmen mit den abgerundeten Kanten.

Die Hochglanzkollektion "PRANA" gibt es in 4 neuen Trenddekoren:

1) weiss/weiss 2) weiss/grey pine 3) weiss/nocce 4) weiss/sandalwood

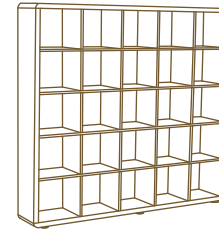

Regal 5x5
185,5 x 185,5 x 35 cm
Art.-Nr.: 11 88 06

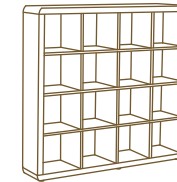

Regal 4x4
150 x 150 x 35 cm
Art.-Nr.: 11 88 01

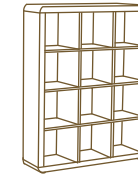

Regal 4x3
150 x 114,5 x 35 cm
Art.-Nr.: 11 88 09



Regal 4x2
150 x 81,5 x 35 cm
Art.-Nr.: 11 88 02



Regal 4x1
150 x 81,5 x 35 cm
Art.-Nr.: 11 88 03

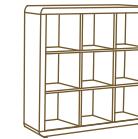

Regal 3x3
114,5 x 114,5 x 35 cm
Art.-Nr.: 11 88 04



Regal 2x2
78,8 x 78,8 x 35 cm
Art.-Nr.: 11 88 05



Regal 1x1
43 x 43 x 35 cm
Art.-Nr.: 11 88 08



Kleiderschrank, 5 Fächer
innen: 2 Kleiderstangen
185,5 x 114,5 x 55 cm
Art.-Nr.: 44 88 01

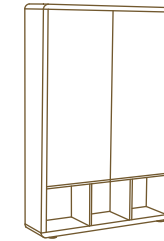

Kleiderschrank, 3 Fächer
innen: 1 Kleiderstange
185,5 x 114,5 x 55 cm
Art.-Nr.: 44 88 02

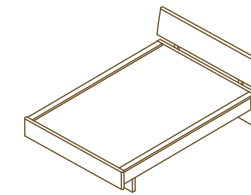

Bett 140 x 200 cm
Art.-Nr.: 41 88 03
Bett 180 x 200 cm
Art.-Nr.: 41 88 04



Beistelltisch 2er Set
Tisch gross: 60 x 30 x 41
Tisch klein: 50 x 30 x 35
Art.-Nr.: 81 73 14

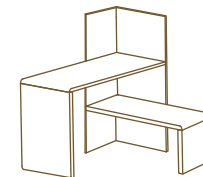

Schreibtisch (74 x 142 x 60 cm)
Lowboard (38 x 110 x 35 cm)
Art.-Nr.: 80 88 01

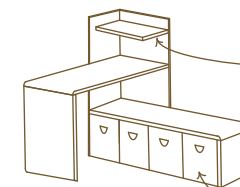

Schreibtisch (74 x 142 x 60 cm)
Lowboard (38 x 146 x 35 cm)
Art.-Nr.: 80 88 02



Wandboard, 60 cm
Art.-Nr.: 16 88 03



Canvas Box
34 x 34 x 34 cm
Art.-Nr.: 81 73 01



Türcontainer
34 x 34 x 34 cm
Art.-Nr.: 11 88 10



Schubladencontainer
34 x 34 x 34 cm
Art.-Nr.: 11 88 11

ergänzen Sie Ihre Schreibtischkombination z.B. mit: