

# ASSEMBLY INSTRUCTION

Ax1

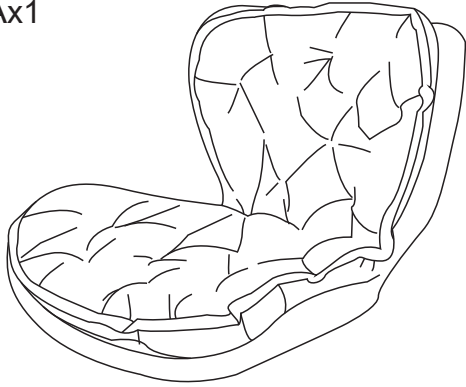

Bx1

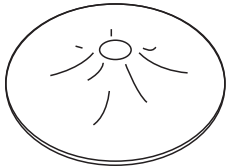

Cx1

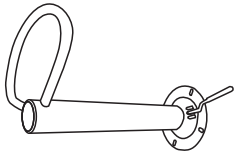

Dx1



Ex4



Fx1

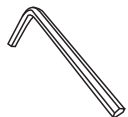

1

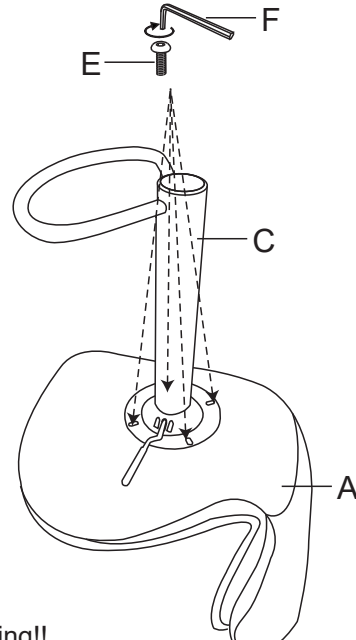

Warning!!  
PUT ALL SCREWS IN THE HOLE,  
THEN TIGHTEN ONE BY ONE.

2

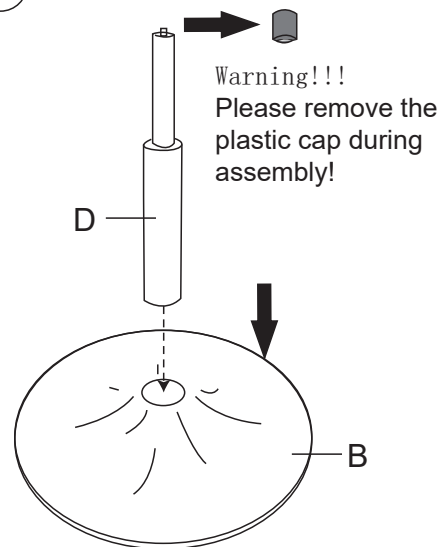

3

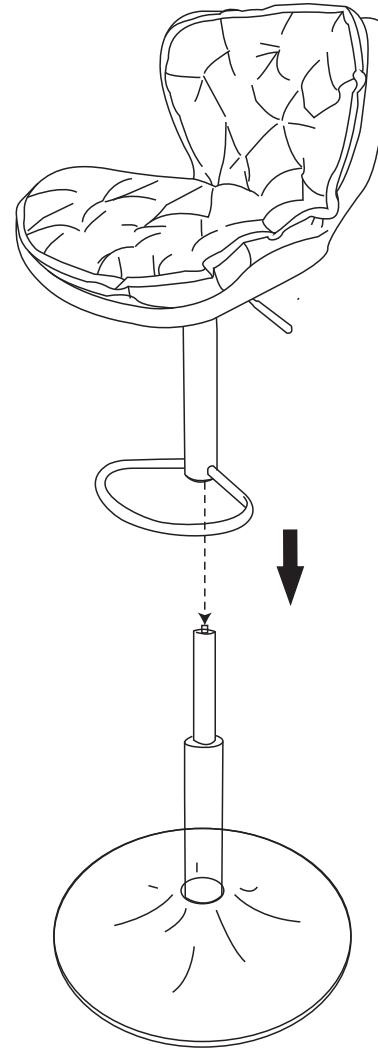

4

