

Art. Nr. 404000

1/7

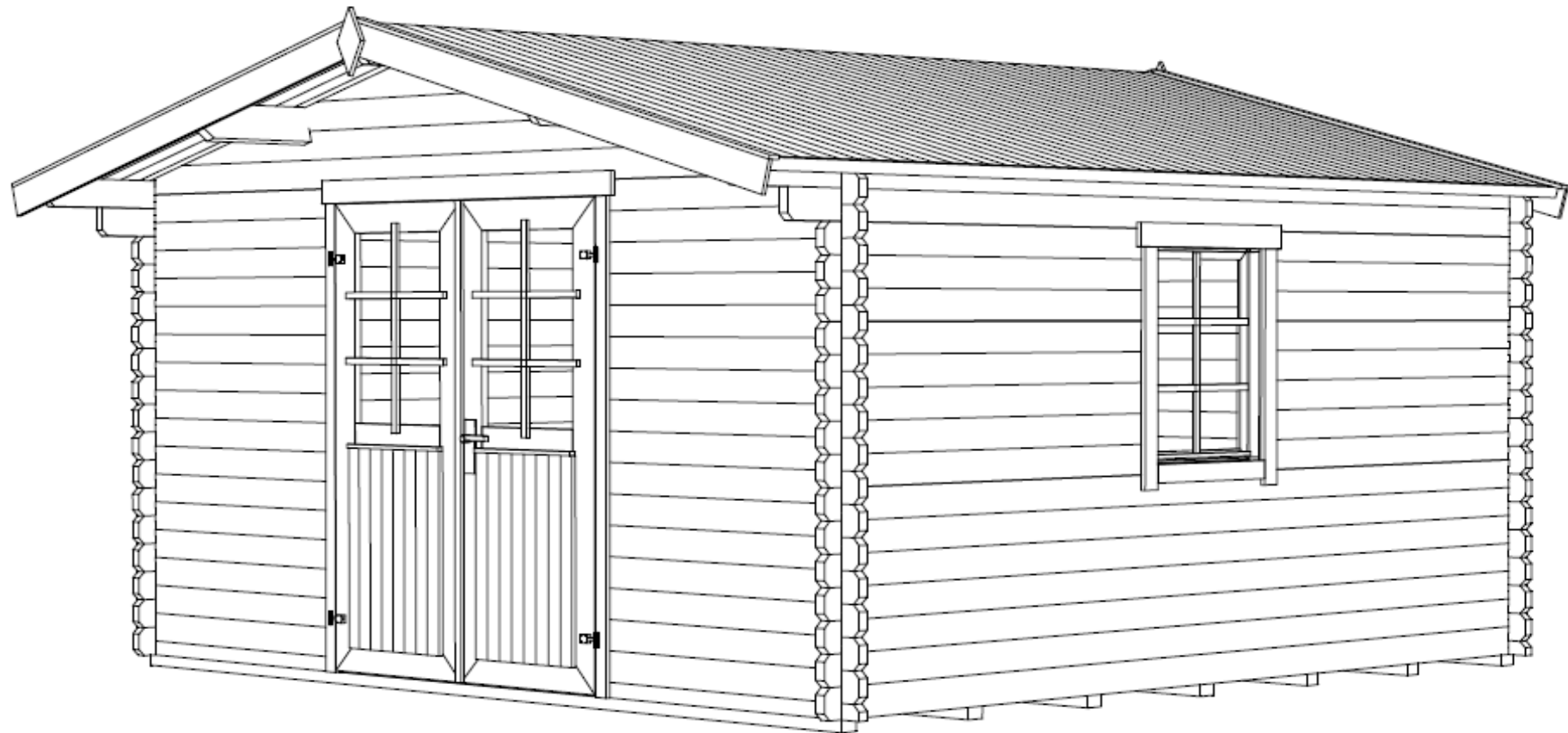

25.01.2017

Art.Nr. 404000

GROUNDPLAN - GRUNDPLAN - PLAN DE MASSE

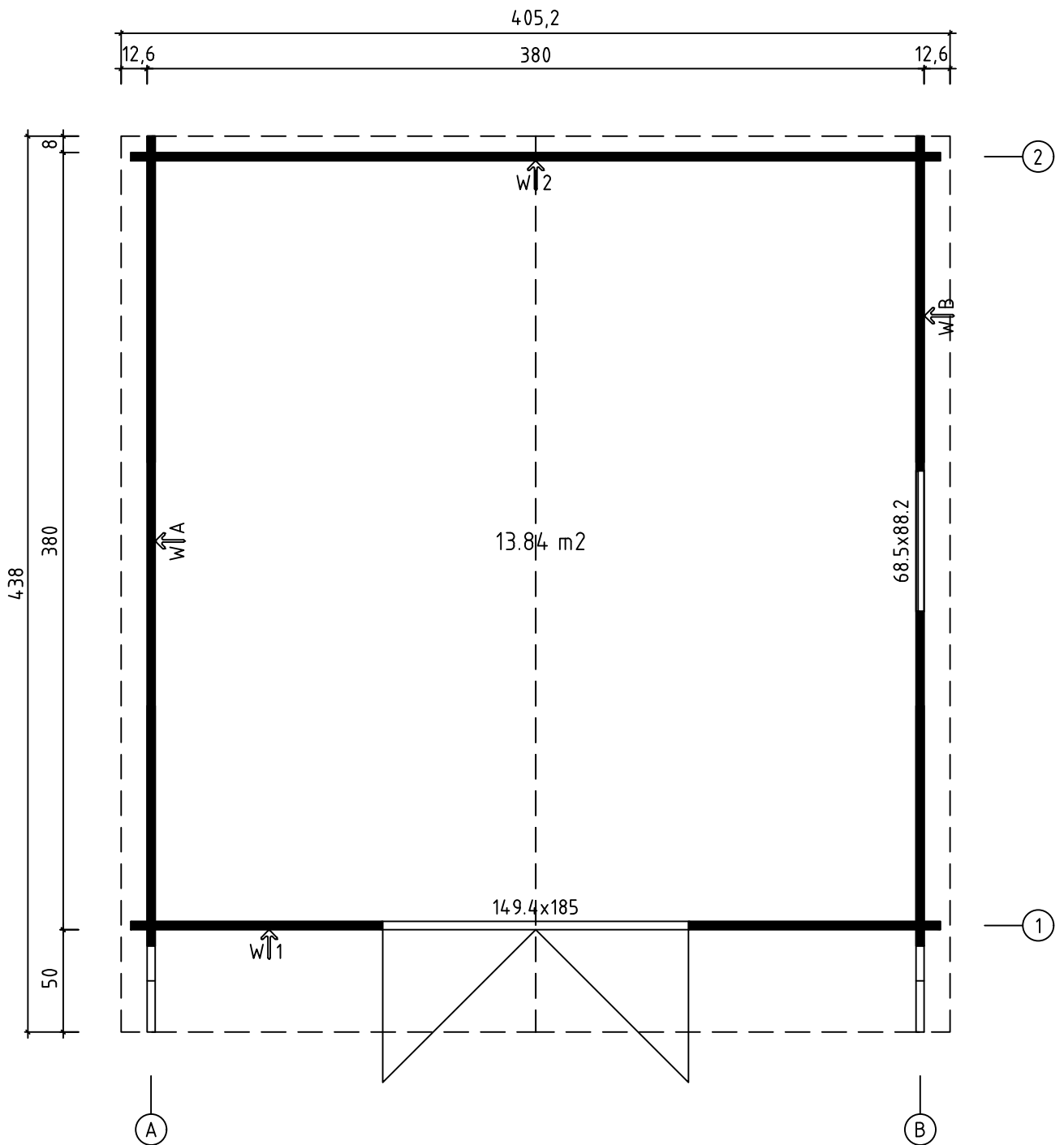

Art.Nr. 404000

FOUNDATION - FUNDAMENT - FONDATION

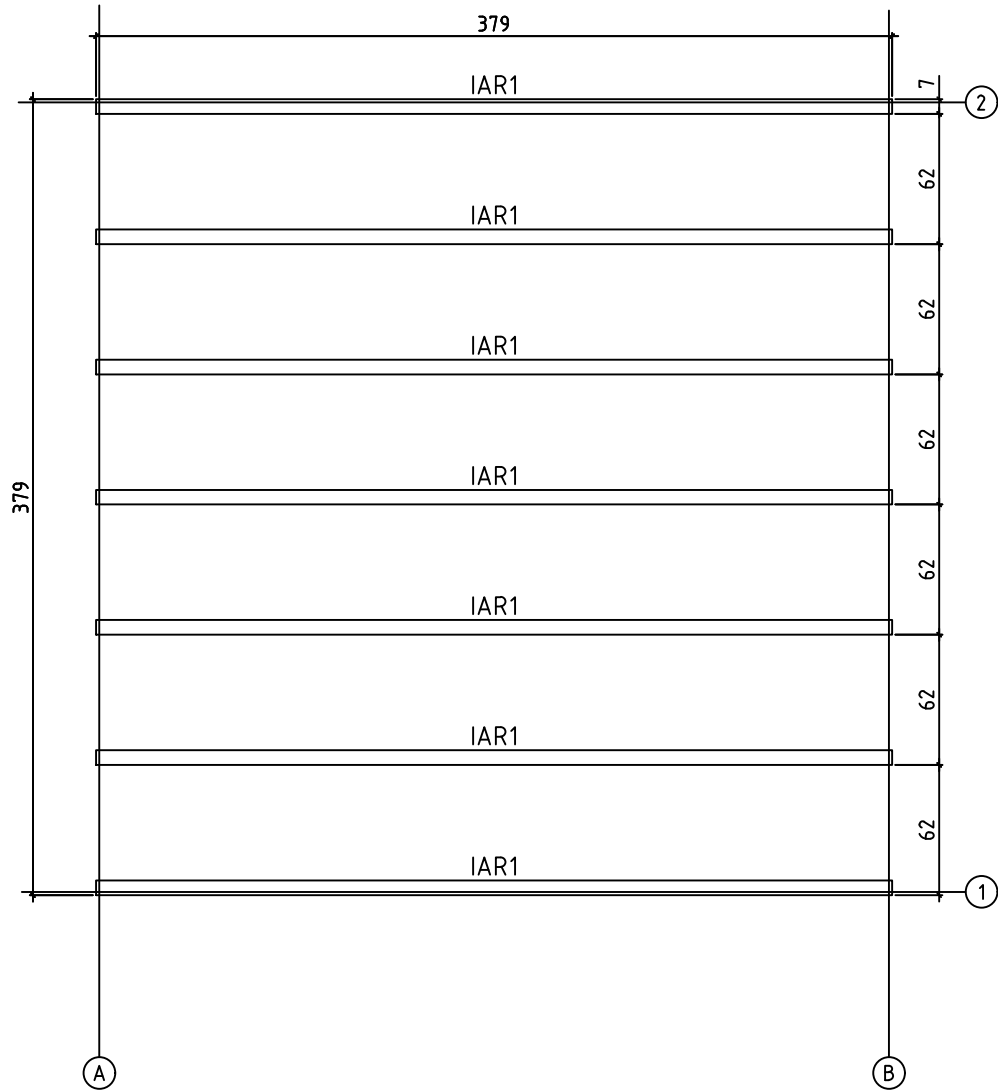



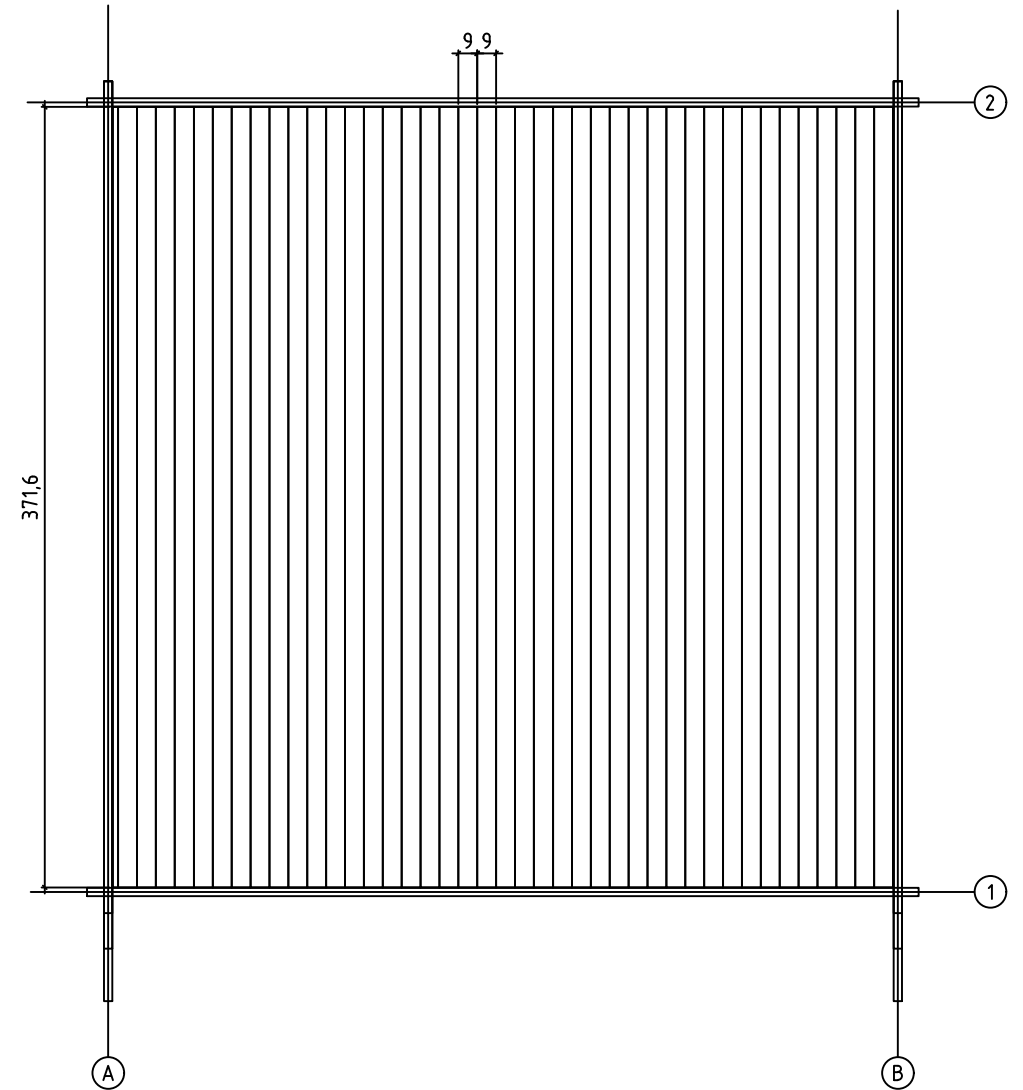



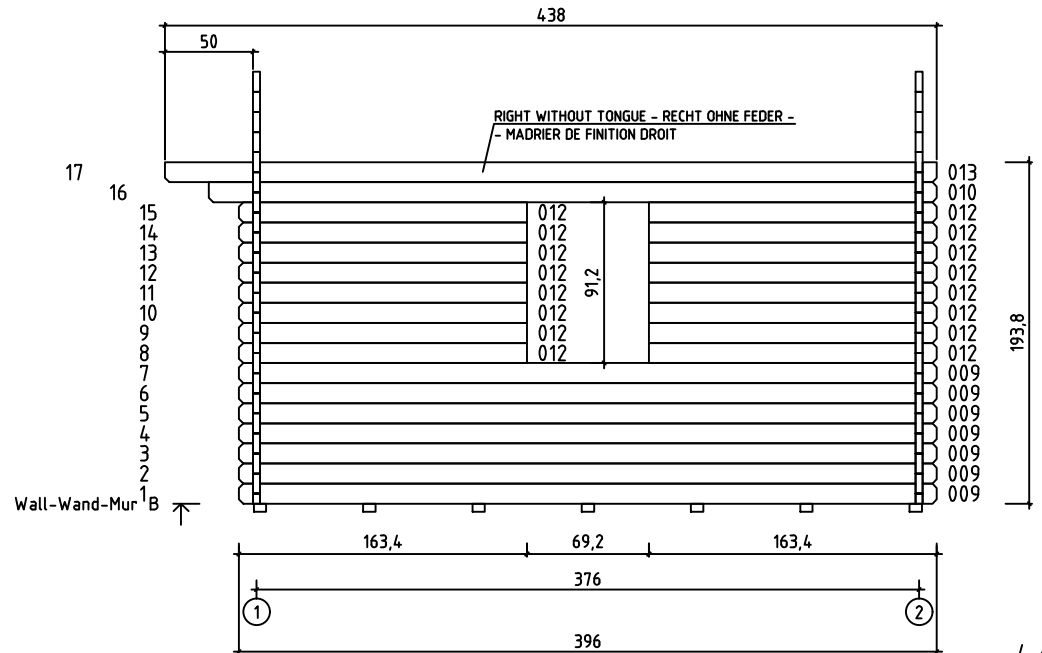
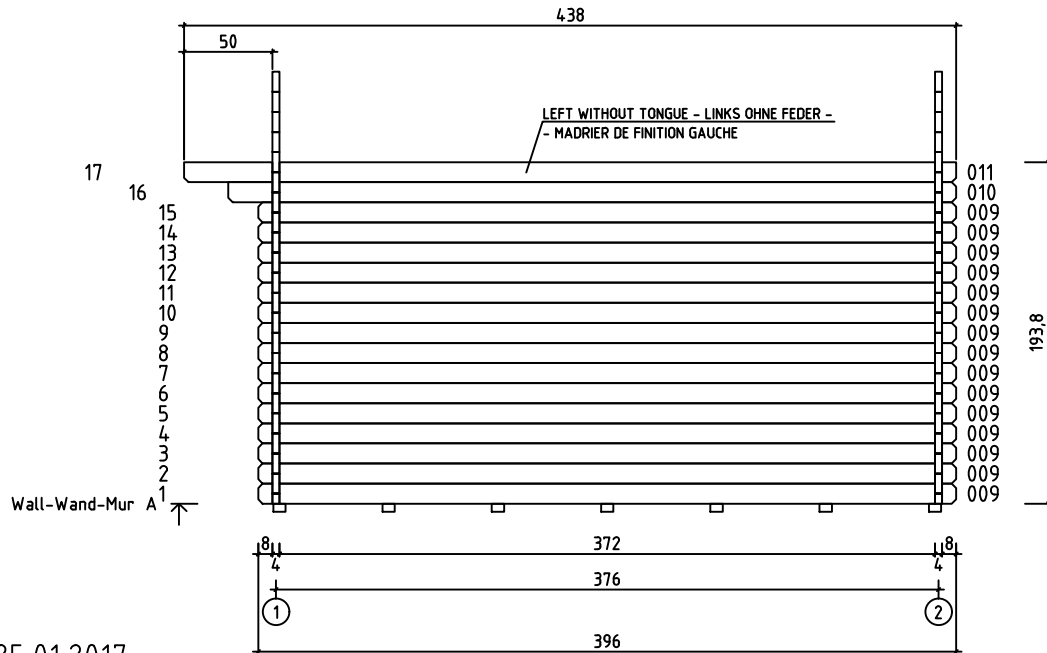
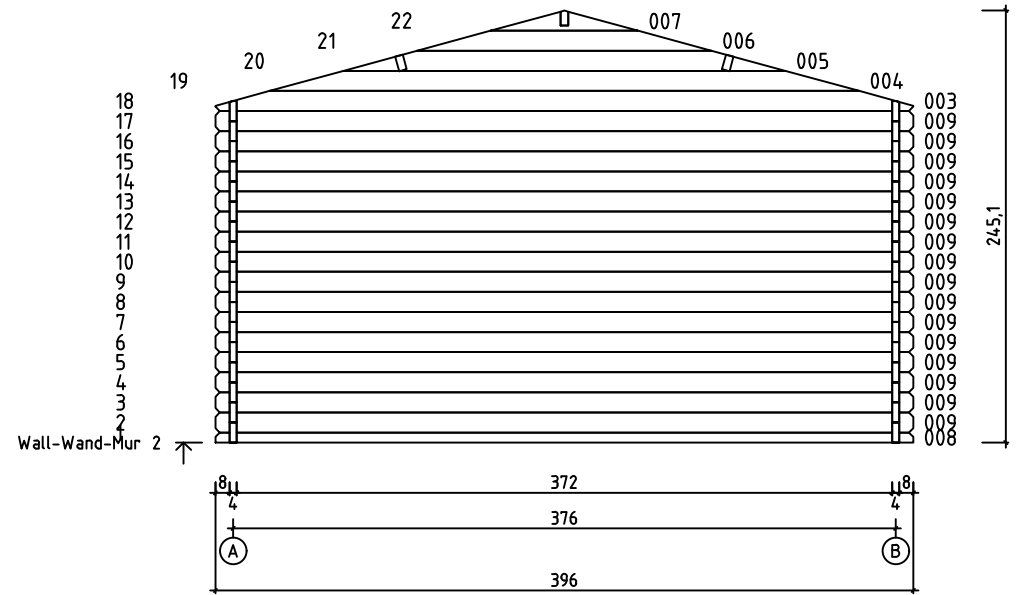
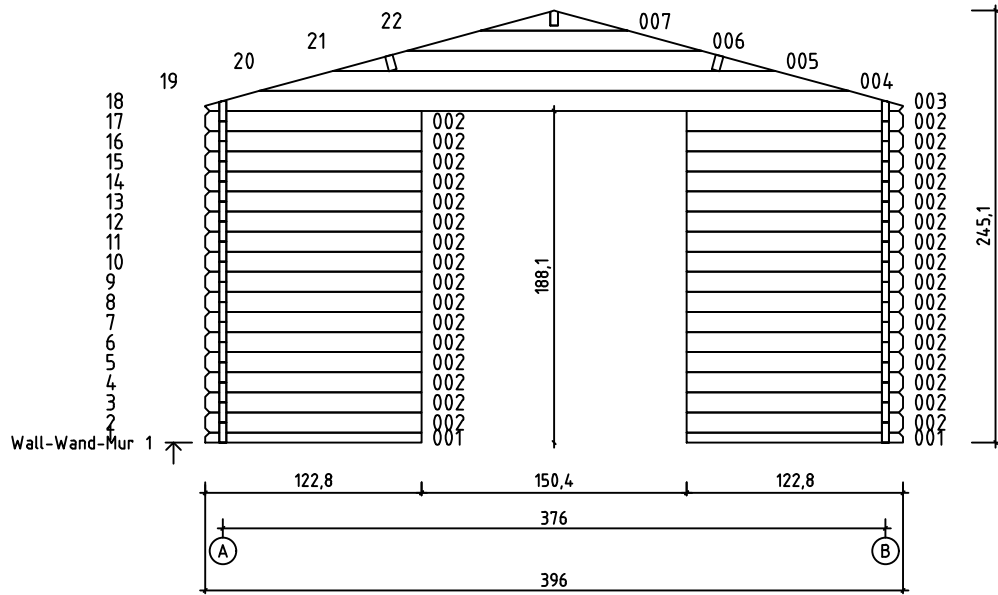



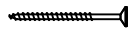
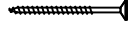

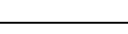
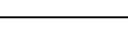
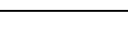

FLOOR BOARDS - FUSSBODENBRETTER - PLAN POSE PLANCHER

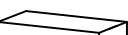
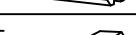
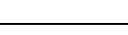
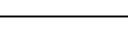
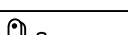

Art.Nr. 404000



Pos	25.01.2017	Piece list - Stückliste - Liste des pièces Art. Nr. 404000	5/7	Q	P (mm)	L (mm)
001				2	40x57	1228
002				32	40x114	1228
008				1	40x57	3960
009				38	40x114	3960
010				2	40x114	4130
011				1	40x120	4380
012				16	40x114	1634
013				1	40x120	4380
W1-1 W2-1				1 1		
IAR1	FOUNDATION - FUNDAMENT - FONDATION			7	70x45	3790
PR1	ROOF BEAM - DACHBALKEN - PANNE DE TOIT			1	44x140	4380
A-PR1	ROOF BEAM - DACHBALKEN - PANNE DE TOIT			2	44x140	4380
	FLOOR BOARDS - FUSSBODENBRETTER - LAME DE PLANCHER			42	90x18	3716
	ROOF BOARDS - DACHBRETTER - VOLIGES			98	90x15	2100
	FLOOR FILLET - FUSSBODENLEISTE - CORNIERE DE FINITION DU PLANCHER				18x18	14.86
	ROOFING FELT FILLET - DACHPAPPENLEISTE - BAGUETTE DE FIXATION DU FEUTRE BITUMEUX			4	15x45	2150
TB-1	FASCIA BOARD - TRAUFBRETT - BANDEAU DE TOIT			4	15x45	2190
KFS-1	STORM PROTECTION - STURMLEISTE - LATTE ANTI-TEMPETE			4	22x45	2050
	GABLE MOULDING - GIEBELLEISTE - PLANCHE DE RIVE			4	15x120	2150
FS1	WINDOW HANDLE FITTINGS - FENSTERGRIFF - POIGNEE DE FENETRE			1		
FSP	BOLT FOR WINDOW HANDLE FITTINGS - BOLZEN FÜR FENSTERGRIFF BESCHLAG - VIS POUR FIXATION POIGNEE DE FENETRE			2		
HS1	SCREW FOR GEORGIAN BARS - SCHRAUBE FÜR SPROSSEN - VIS DE BARRES GEORGIENNE			18	2.5x20	
HS8	SCREW FOR GABLE SEGMENT - SCHRAUBEN FÜR DECKBLATT - VIS POUR FIXATION LOSANGE DE FINITION			4	3.5x35	
	SCREW FOR FIXING DOOR TO THE WALL - SCHRAUBE ZUR BEFESTIGUNG TÜR - ZARGE MIT WAND - VIS DE FIXATION PARTIE BASSE DORMANTS DE PORTE AU 1ER RANG DE MADRIER			2	3.5x50	

Pos	25.01.2017	Piece list - Stückliste - Liste des pièces Art. Nr. 404000	6/7	Q	P (mm)	L (mm)
HS9	SCREW FOR GABLE MOULDING - SCHRAUBEN FÜR GIEBELLEISTE - VIS POUR FIXATION PLANCHE DE RIVE		24	3.5x50		
HS4	SCREW FOR DOORSTEP - SCHRAUBEN FÜR SWELLE - VIS POUR FIXATION BARRE DE SEUIL		3	3x30		
HS4	SCREW FOR DOOR FILLET - SCHRAUBE ZUR BEFESTIGUNG TÜRLEISTE - VIS POUR FIXATION BAGUETTE D'ARRET DE PORTE		5	3x30		
HS11	SCREW FOR FIXING BOLT HINGE - SCHRAUBE FÜR TÜRRIEGEL - VIS POUR FIXATION GONDS DE PORTE - POUR OUVRANT		16	4x30		
HS12	SCREW FOR FASCIA BOARDS - SCHRAUBEN FÜR TRAUFBRETTER - VIS POUR FIXATION BANDEAU DE TOIT		20	4x40		
HS12	SCREW FOR FIXING BOLT HINGE - SCHRAUBE FÜR TÜRRIEGEL - VIS POUR FIXATION GONDS DE PORTE - POUR OUVRANT		12	4x40		
HS13	SCREW FOR DOOR JAMB - SCHRAUBE FÜR TÜRRAHMEN - VIS DE FIXATION PARTIE HAUTE AVEC MONTANTS DU CADRE DE PORTE		2	4x60		
HS18	SCREW FOR ROOF BEAMS - SCHRAUBEN FÜR DACHBALKEN - VIS POUR FIXATION PANNES DE TOIT		10	5x120		
HS16	SCREW FOR 1. WALL BEAM - SCHRAUBE FÜR 1. BOHLENREIHE - VIS DE FIXATIONS 1ere RANGÉE DE MADRIERS AVEC POUTRELLES DE FONDATIONS		7	5x90		
HS16	SCREW FOR DOOR JAMB - SCHRAUBE FÜR TÜRRAHMEN - VIS DE FIXATION PARTIE HAUTE AVEC MONTANTS DU CADRE DE PORTE		2	5x90		
NF2	ZN NAIL FOR FLOOR FILLET - ZN NÄGEL FÜR FUSSBODENLEISTE - POINTE POUR CORNIERE DE FINITION DU PLANCHER		30	1.4x40		
SH40	HAMMER BLOCK - SCHLAGHOLZ - CALLE DE FRAPPE		1			
SFS	NUT FOR STORM PROTECTION - SCHRAUBENMUTTER FÜR STURMLEISTE - ECROU POUR LATTE ANTI-TEMPETE		8	D6		
NF4	ZN NAIL FOR ROOF - ZN NÄGEL FÜR DACHBRETTER - POINTE POUR FIXATION VOLIGES DE TOIT		308	2x50		
NF4	ZN NAIL FOR FLOOR - ZN NÄGEL FÜR FUSSBODENBRETTER - CLOUS POUR PLANCHER		301	2x50		
NF5	ZN NAIL FOR ROOFING FELT FILLET - ZN NÄGEL FÜR DACHPAPPENLEISTE - POINTE POUR BAGUETTE DE FIXATION FEUTRE BITUMEUX		20	2x40		
	MALE BOLT HINGE FOR DOOR - TÜRRIEGEL - PARTIE MALE DE PAUMELLE DE PORTE		4	DIN15-57		
BFS	BOLT FOR STORM PROTECTION - BOLZEN FÜR STURMLEISTE - BOULON POUR LATTE ANTI-TEMPETE		8	6x70		
TL	LATCH BOLT FOR DOUBLE DOOR - TORRIEGEL - LOQUET POUR DOUBLE PORTE		2		90	
GS	GABLE SEGMENT - DECKBLATT - LOSANGE DE FINITION		2			
DFS	WASHER FOR STORM PROTECTION - DICHTSCHEIBE FÜR STURMLEISTE - RONDELLE POUR LATTE ANTI-TEMPETE		8	D6		
TL4	DOOR HANDLE FITTINGS - TÜRGRIF - POIGNEE DE PORTE		1			
TL5	SET OF DOOR LOCK COVERS - SCHLOSSBLENDEN - SET DE GARNITURES DE PORTE		1			
	CYLINDER LOCK - ZYLINDERSCHLOSS - BARILLET DE PORTE		1	30/30		

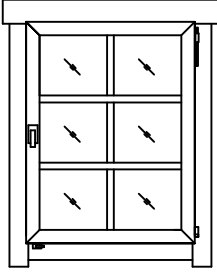
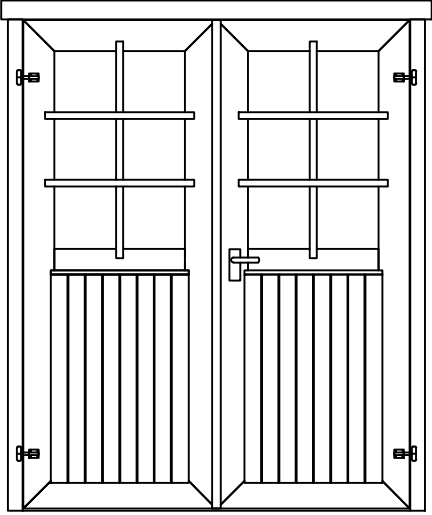
Pos	25.01.2017	Piece list - Stückliste - Liste des pièces Art. Nr. 404000	7/7	Q	P (mm)	L (mm)
	WINDOW - FENSTER - FENETRE 685x882 SGC		AK.1.106.SSP.d	1		
						
	DOOR - TÜR - PORTE 1494x1850 SGA+28		TUK.2.056.SVP.MX40	1		
						

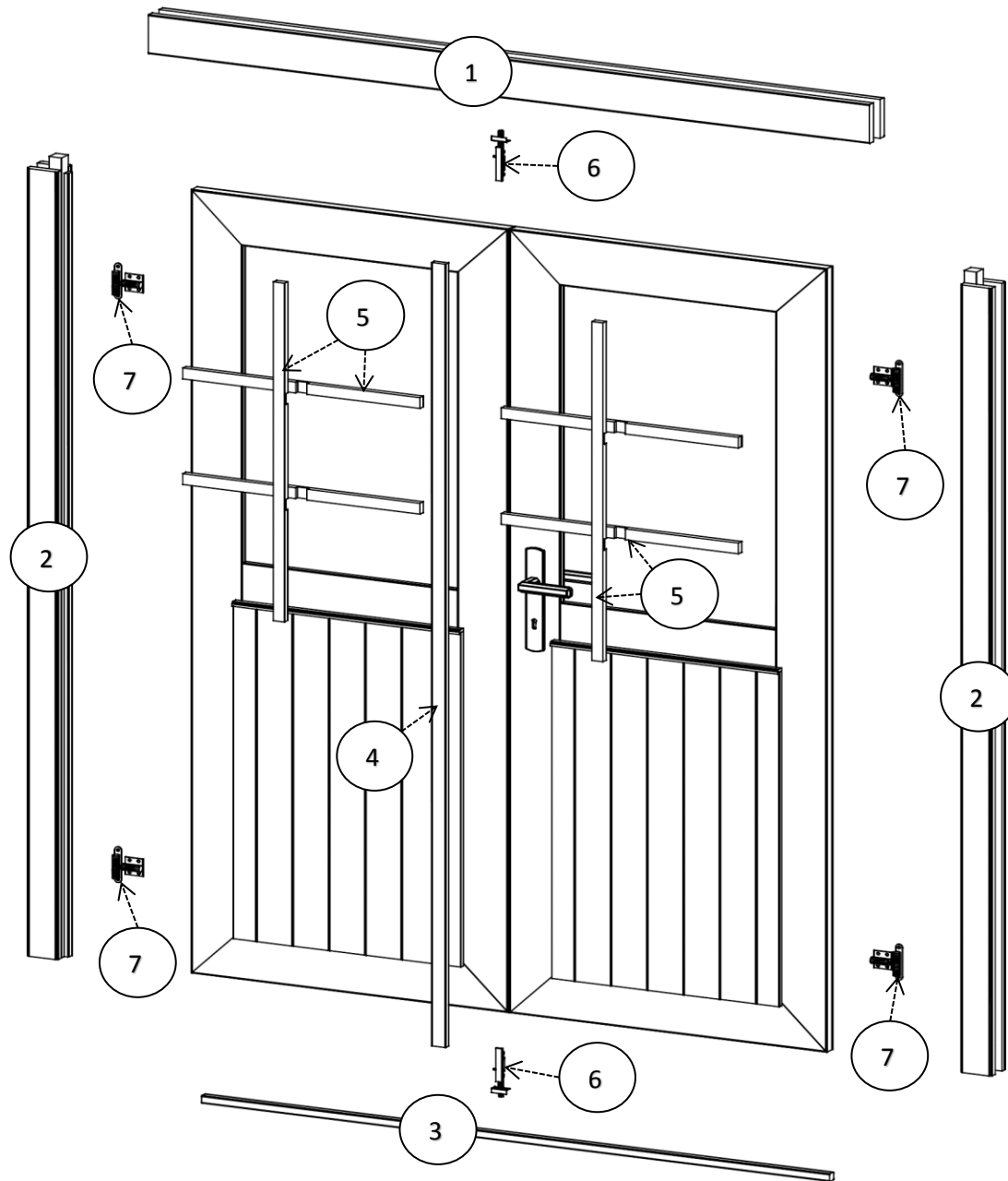

Allgemeine Montageanleitung - General assembly instructions - Instructions générales de montage

Pos	Piece list - Stückliste - Liste des pièces	Q.	P (mm)
1		1	77x100
2		2	77x80
3		1	18x29
4		1	13x32
5		6	15x25
6		2	
7		4	

Metall Tüschwelle gehört nicht zum Lieferumfang - Metal sill cover not included - Seuil de porte en métal non-inclus

