

Metal Gerätehaus 3 Foot x 5 Foot

91.44 x 152.4 cm

Montageanleitung

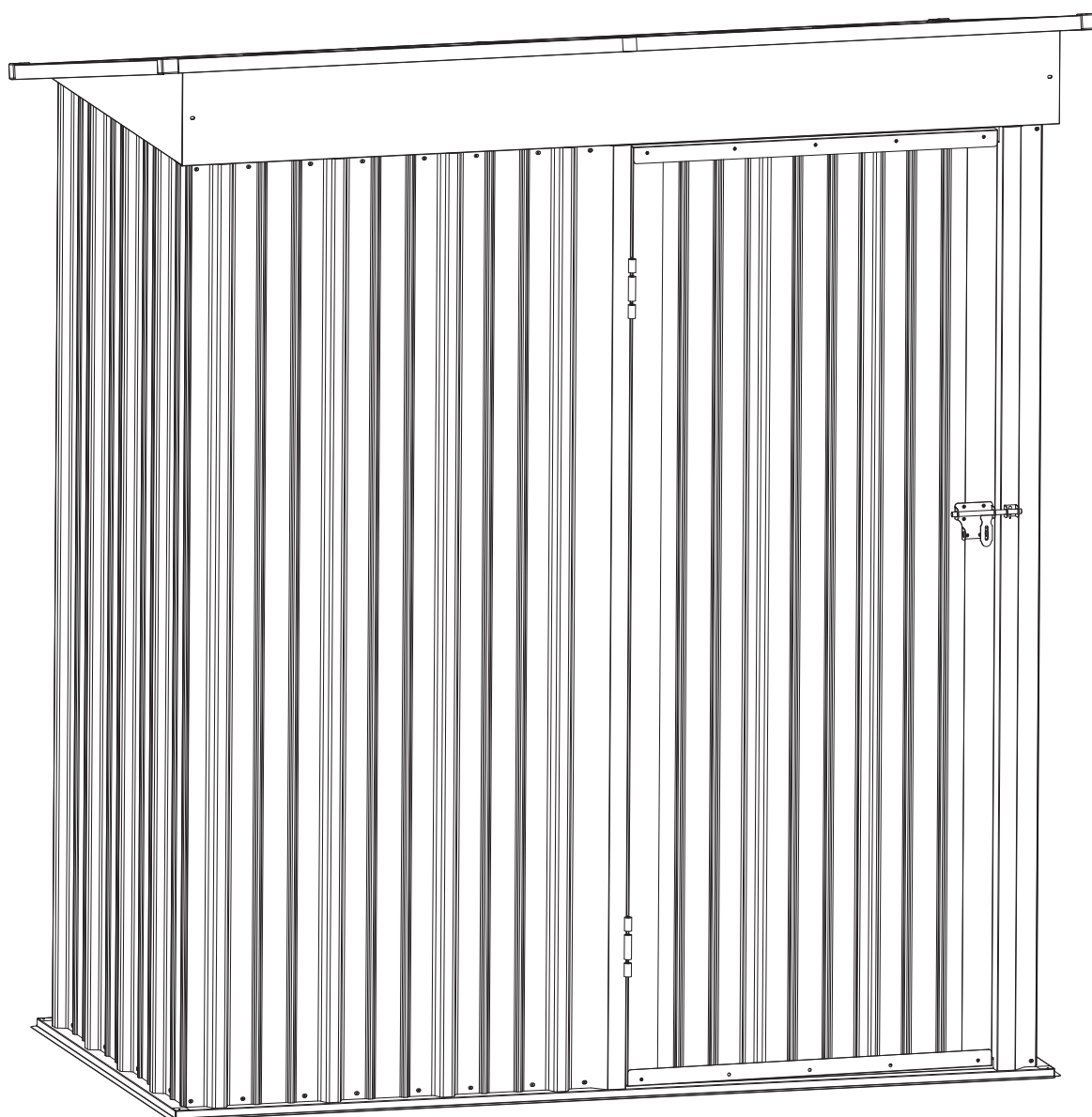

Für die Installation sind zwei Personen und 2–3 Stunden erforderlich.

Es wird empfohlen, Handschuhe zu tragen, um Kratzer zu vermeiden.

PLANEN SIE VORAUS

Bevor Sie mit der Installation beginnen, prüfen Sie die örtlichen Bauvorschriften in Bezug auf Fundamente, Standort und andere Anforderungen. Lesen und verstehen Sie diese Anleitung.

Wichtige Informationen und hilfreiche Tipps machen Ihre Installation einfacher und angenehmer.

Werkzeuge und Materialien: Für die Installation benötigen Sie einige grundlegende Werkzeuge und Materialien. Entscheiden Sie, welche Verankerungsmethode und welche Art von Fundament Sie verwenden möchten, um eine vollständige Liste der benötigten Materialien zu erstellen.

BEVOR SIE BEGINNEN

Montageanleitung: In diesem Handbuch finden Sie Anweisungen, die alle für Ihre Installation relevanten Informationen enthalten.

Lesen Sie alle Anweisungen durch, bevor Sie beginnen, und befolgen Sie während der Montage die Schrittfolge sorgfältig, um korrekte Ergebnisse zu erzielen.







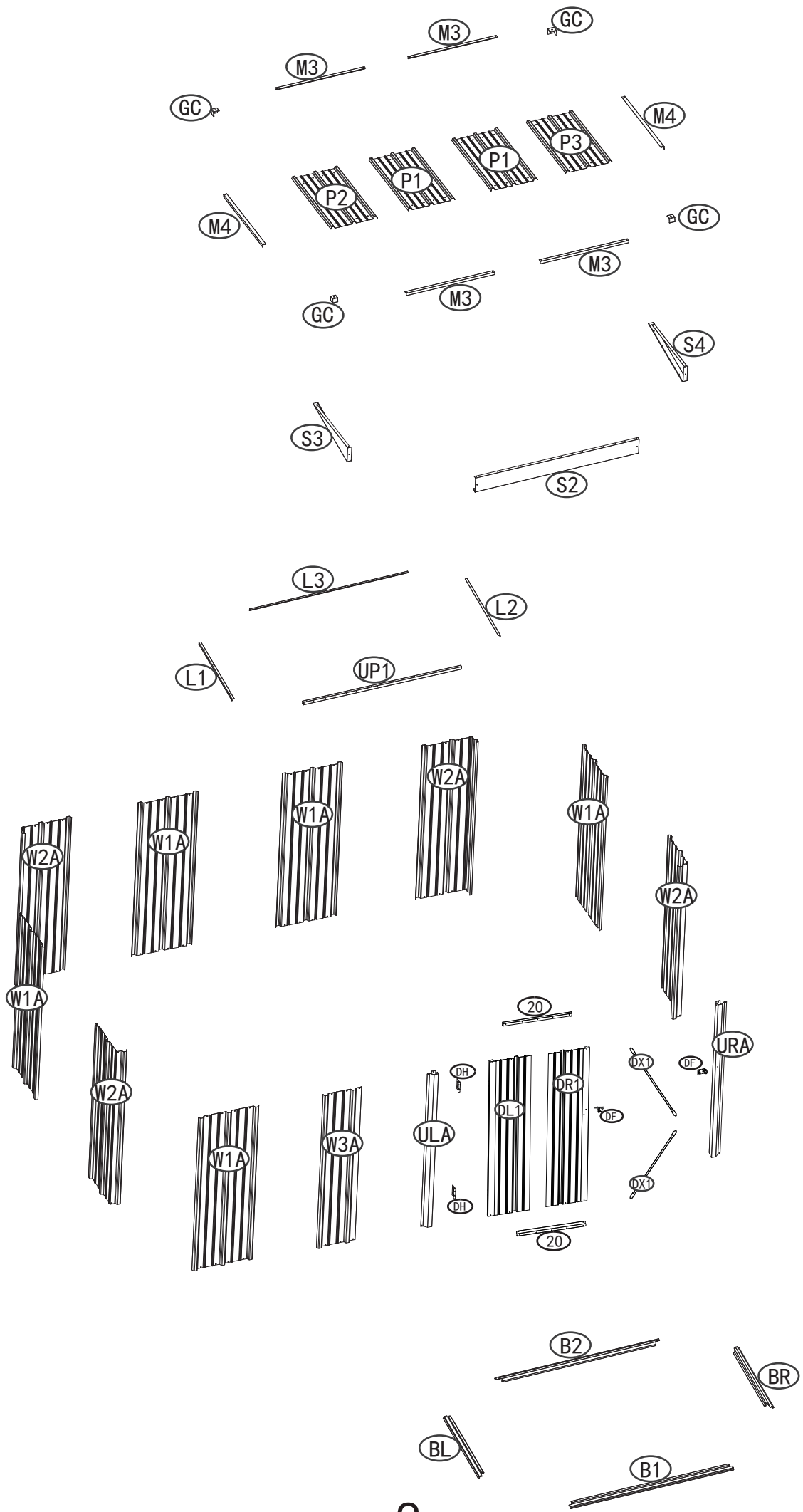











Parts List: Überprüfen Sie, ob Sie alle erforderlichen Teile und Mengen in Ihrem Paket haben. Diese sind im Karton verpackt. Beachten Sie, dass zusätzliche Befestigungselemente für Ihre Bequemlichkeit mitgeliefert wurden.













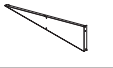



Diagramm der Installationsanleitung: Alle Teile außer Schrauben und Bolzen sind in diesem Diagramm dargestellt. Überprüfen Sie alle Teile, bevor Sie beginnen. Machen Sie sich mit der Hardware und den Befestigungselementen vertraut, um die Verwendung während der Installation zu erleichtern.



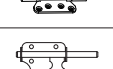

Tipps: Bewegen Sie nach Beginn der Installation das Fundament/den Rahmen nicht, da dies zu einer Asymmetrie der Lochpositionen führen und den Installationsfortschritt beeinträchtigen kann!







PARTS LIST

PART	NO.	Qty.
	B1	1
	B2	1
	BL	1
	BR	1
	L1	1
	L2	1
	L3	1
	UP1	1
	M3	4
	M4	2
	W1A	5
	W2A	4
	W3A	1
	ULA	1
	URA	1
	20	2
	DL1	1
	DR1	1

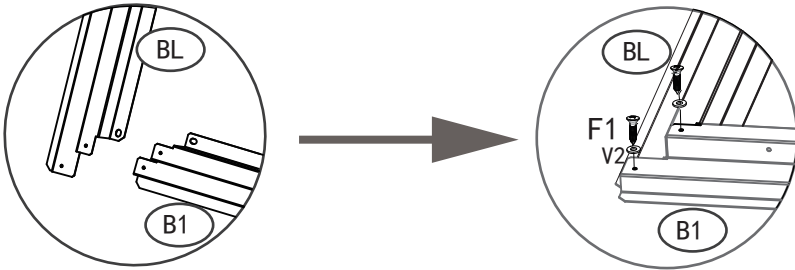
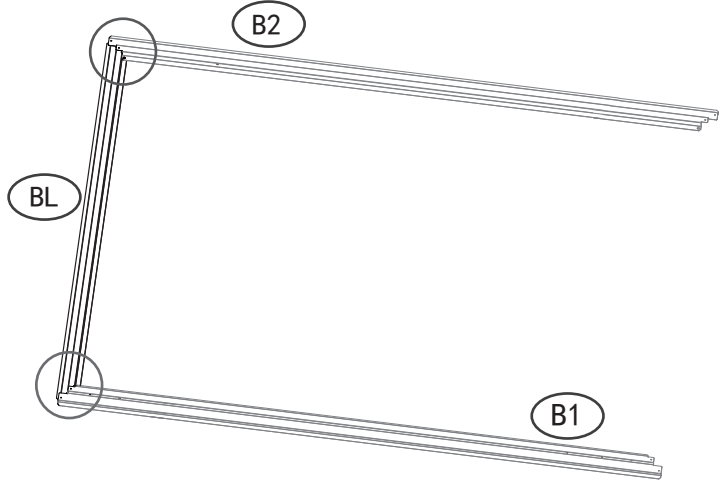
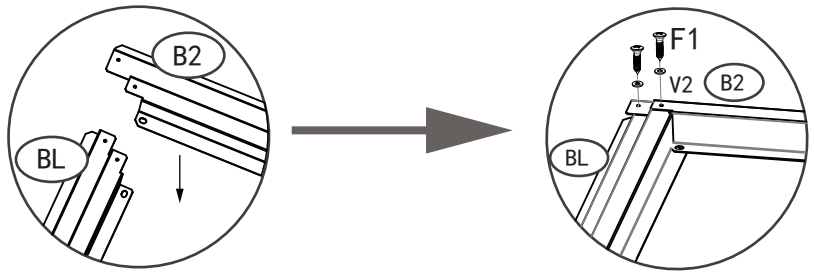

PART	NO.	Qty.
	S2	1
	S4	1
	S3	1
	P1	2
	P2	1
	P3	1
	GC	4
	F1	163
	F2	8
	F3	16
	V2	149
	V1	122
	DF	1
	DX1	2
	DH	2
	DG	1
	F6	4
		1

PART	NO.	Qty.
	B1	1
	B2	1
	BL	1
	F1	4
	V2	4



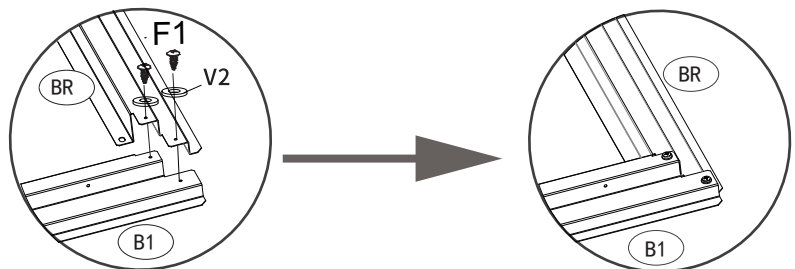
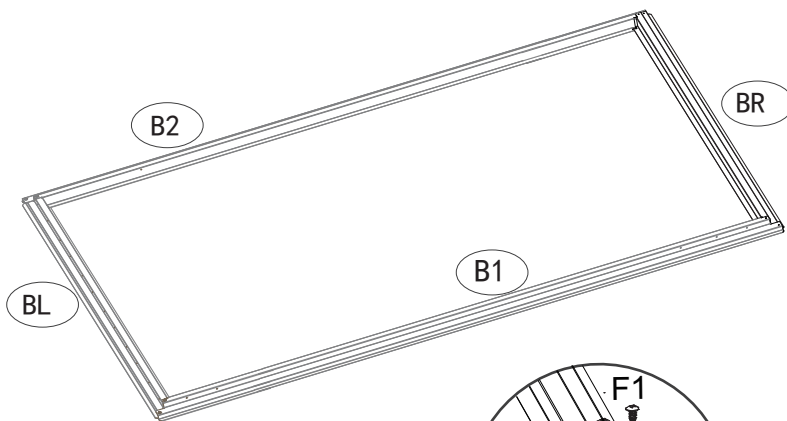
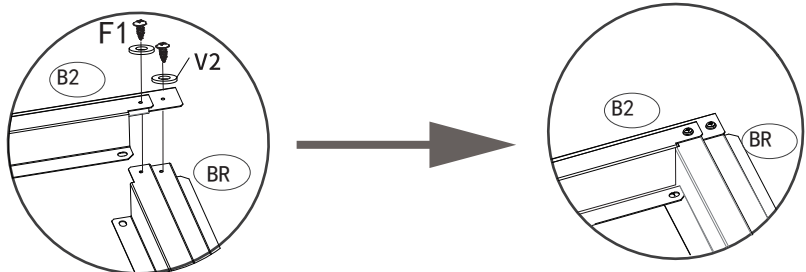

PART	NO.	Qty.
	BR	1
	F1	4
	V2	4



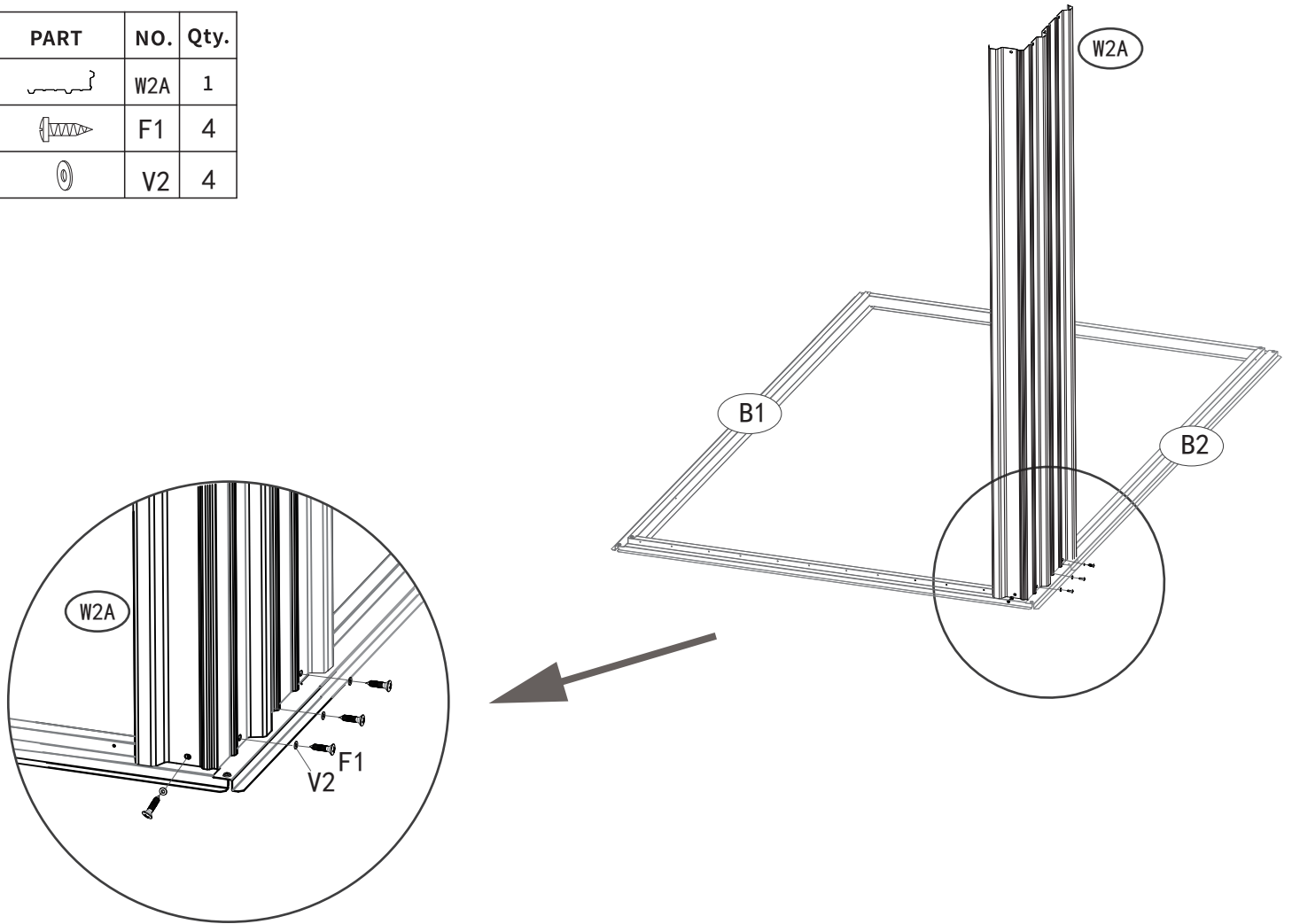

PART	NO.	Qty.
	W2A	1
	F1	4
	V2	4



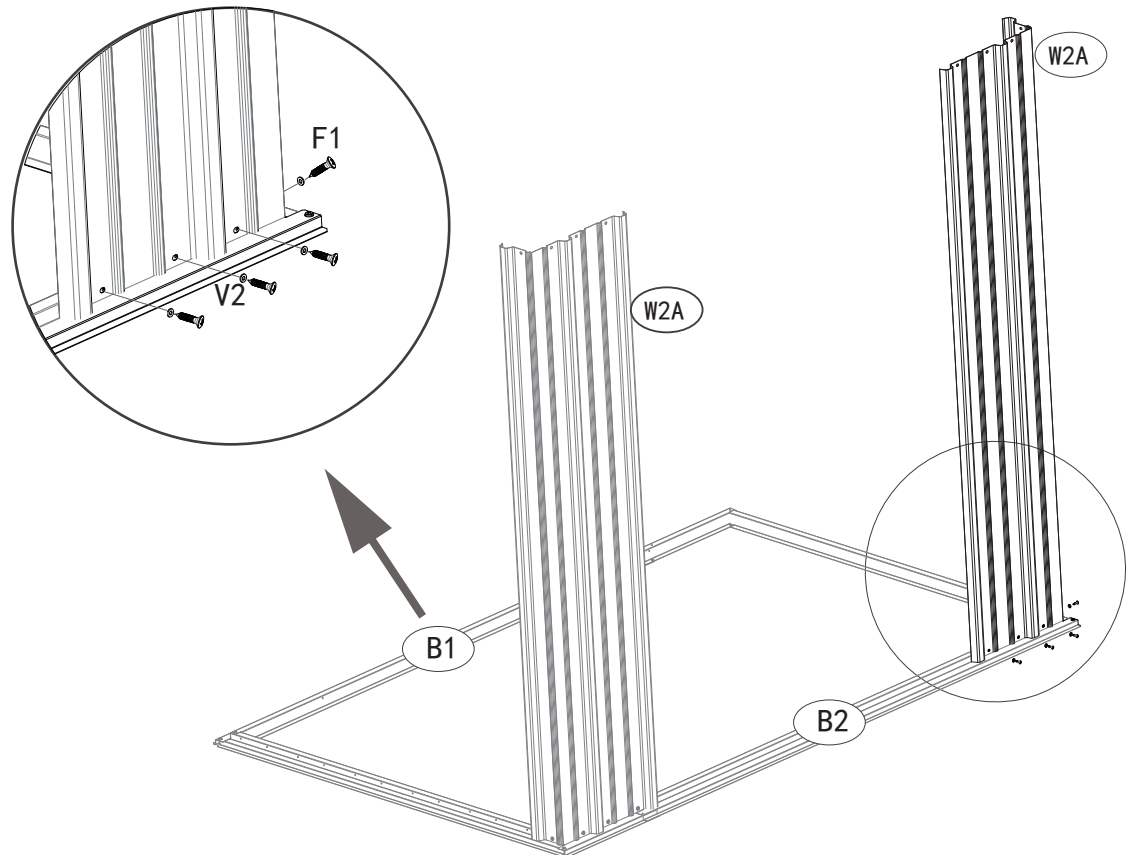

PART	NO.	Qty.
	W2A	1
	F1	4
	V2	4



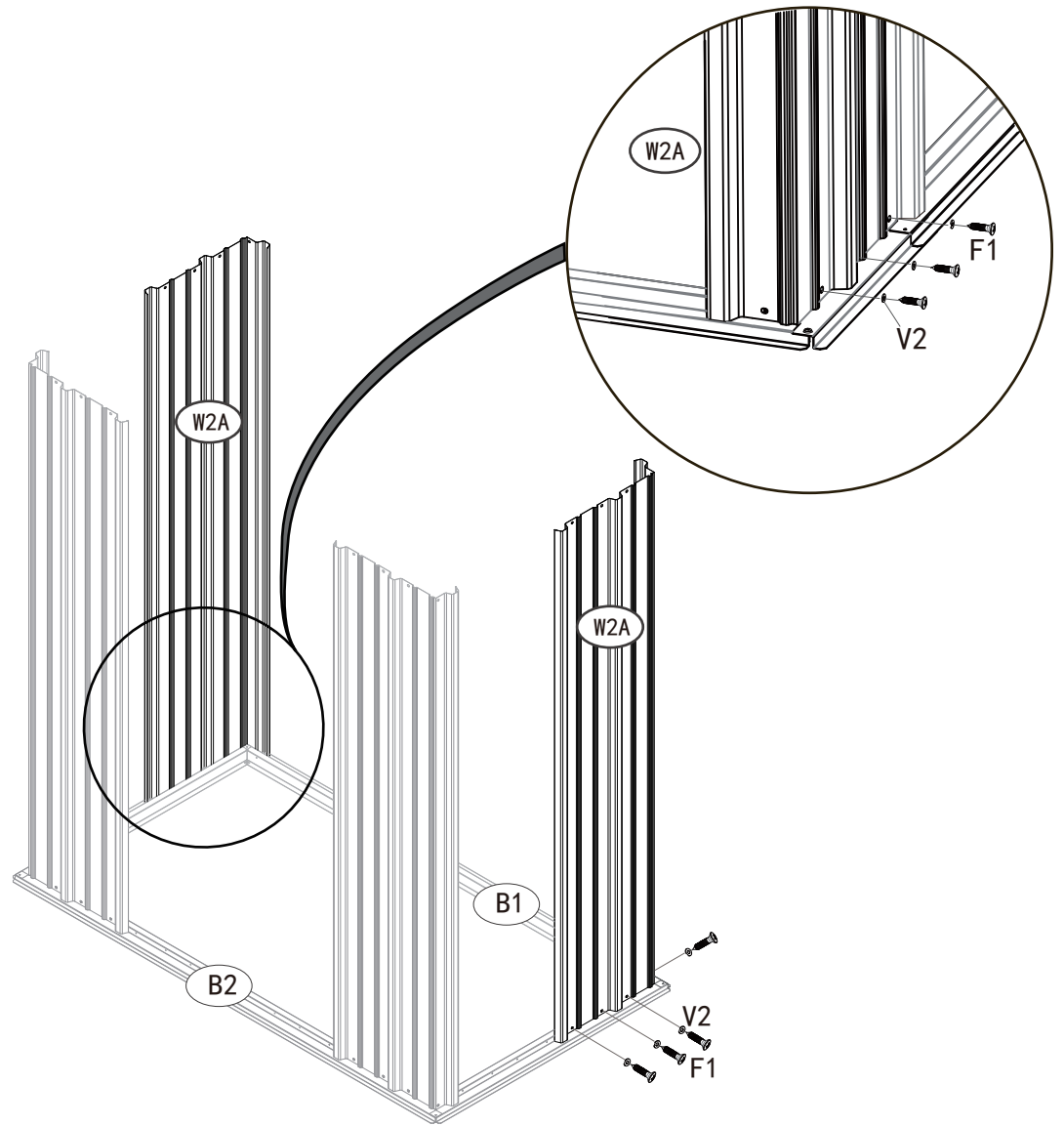



PART	NO.	Qty.
	W2A	2
	F1	8
	V2	8



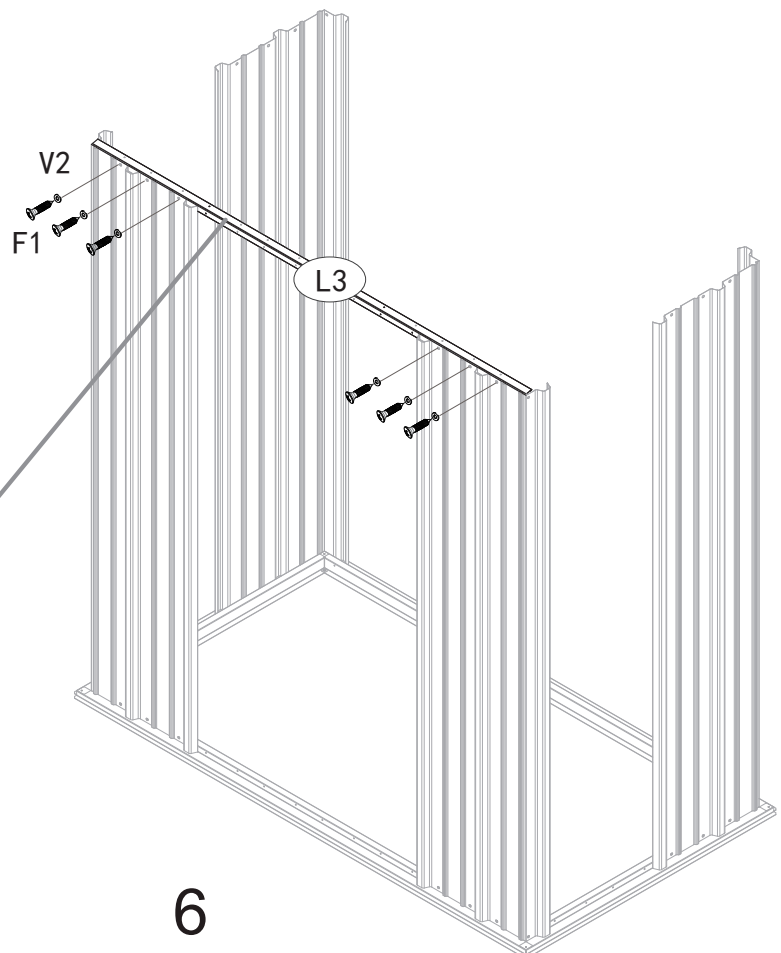
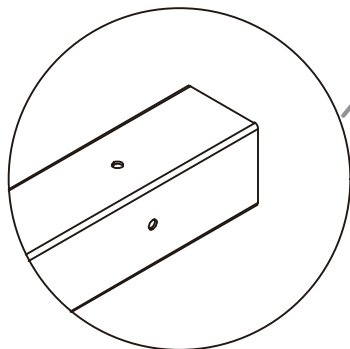



PART	NO.	Qty.
	L3	1
	F1	6
	V2	6

L3 wird wie in der Abbildung gezeigt nach unten montiert.

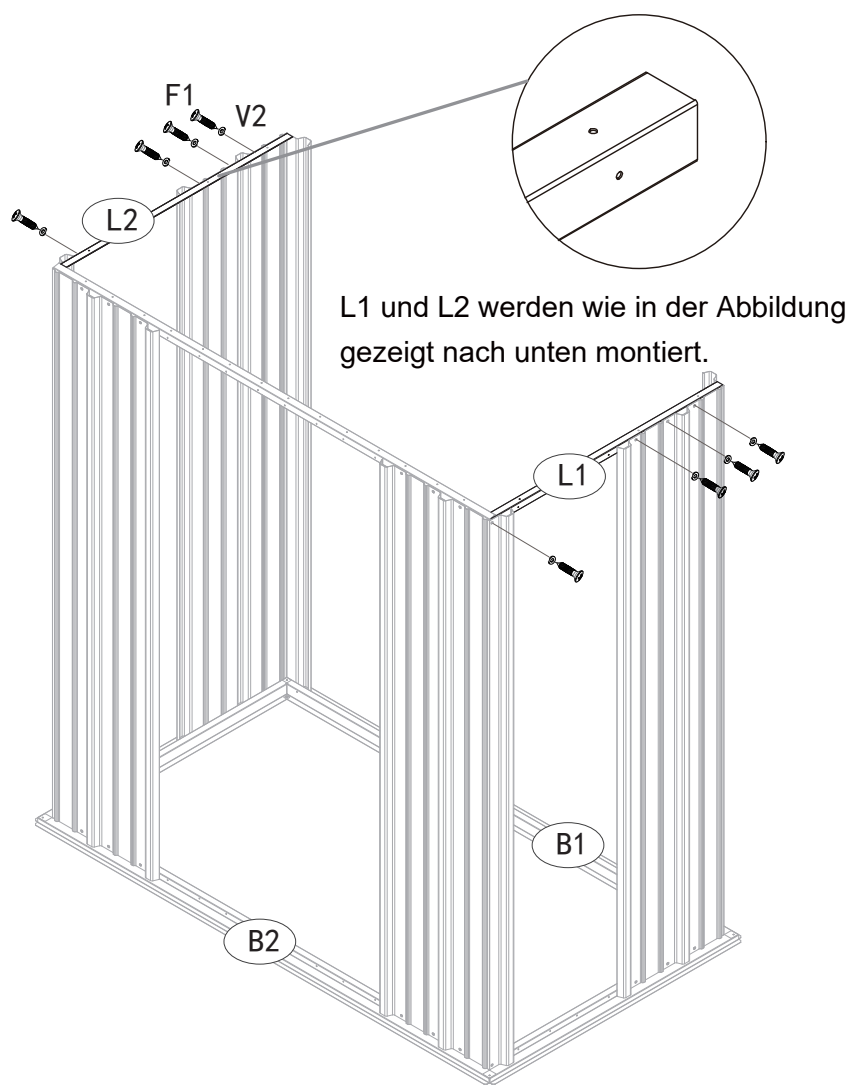



PART	NO.	Qty.
	L1	1
	L2	1
	F1	8
	V2	8



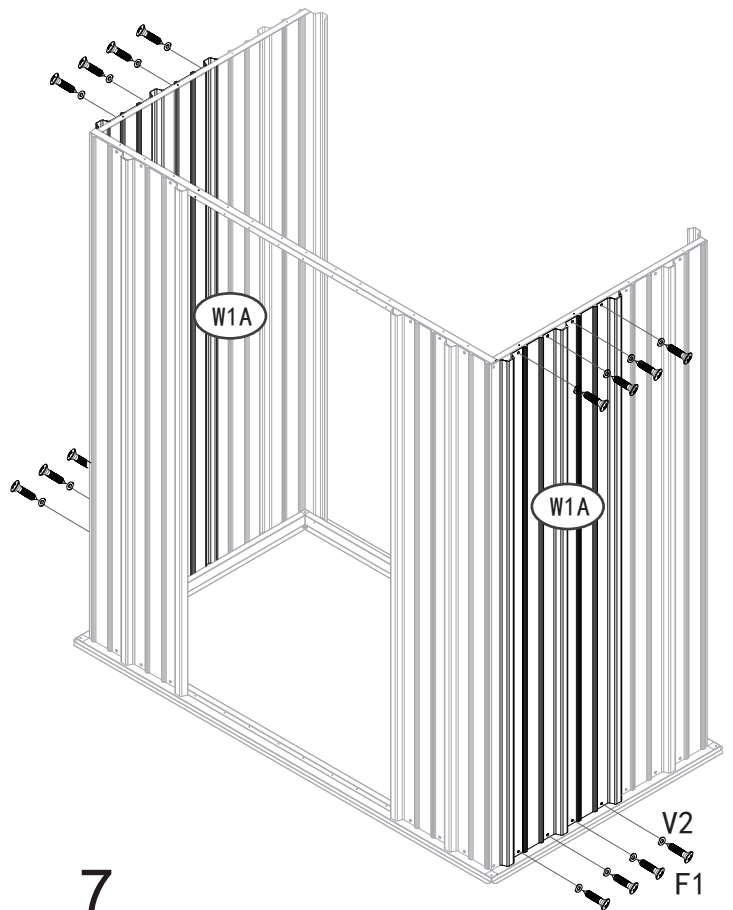

PART	NO.	Qty.
	W1A	2
	F1	16
	V2	16



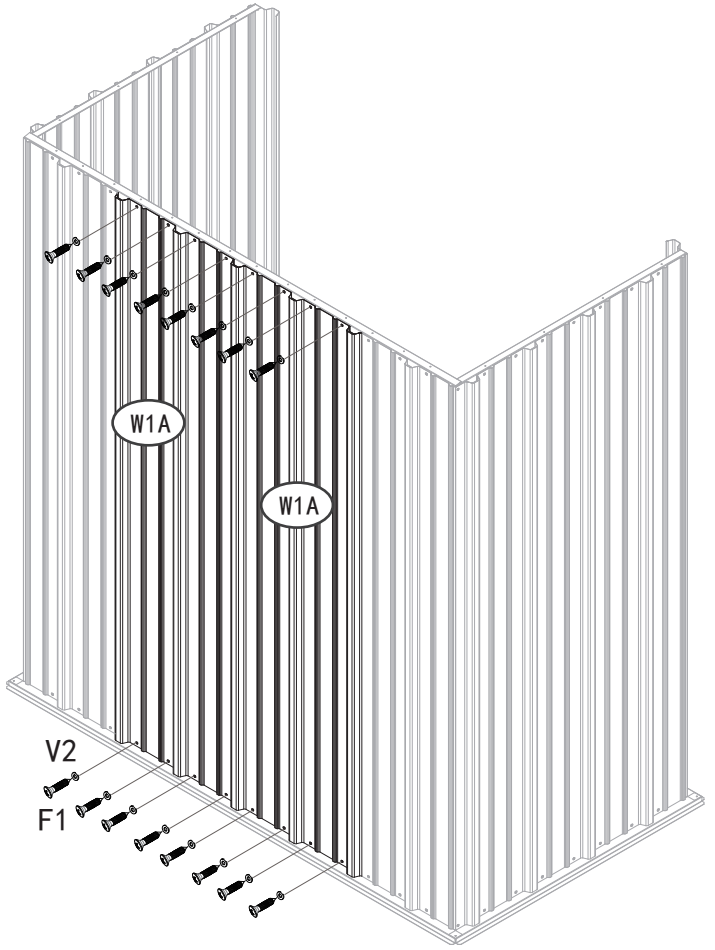

PART	NO.	Qty.
	W1A	2
	F1	16
	V2	16



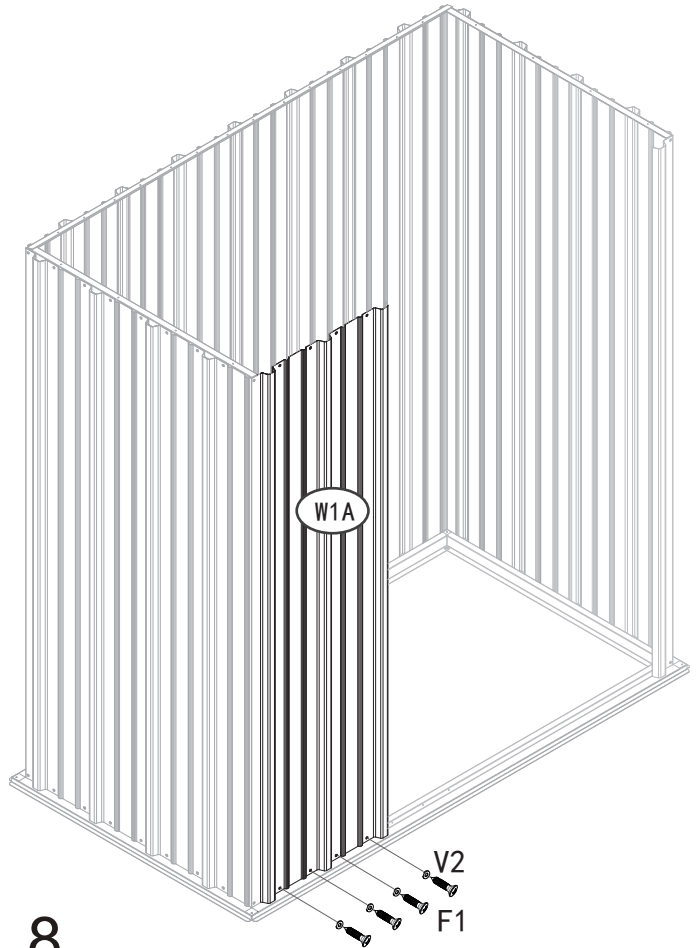

PART	NO.	Qty.
	W1A	1
	F1	4
	V2	4



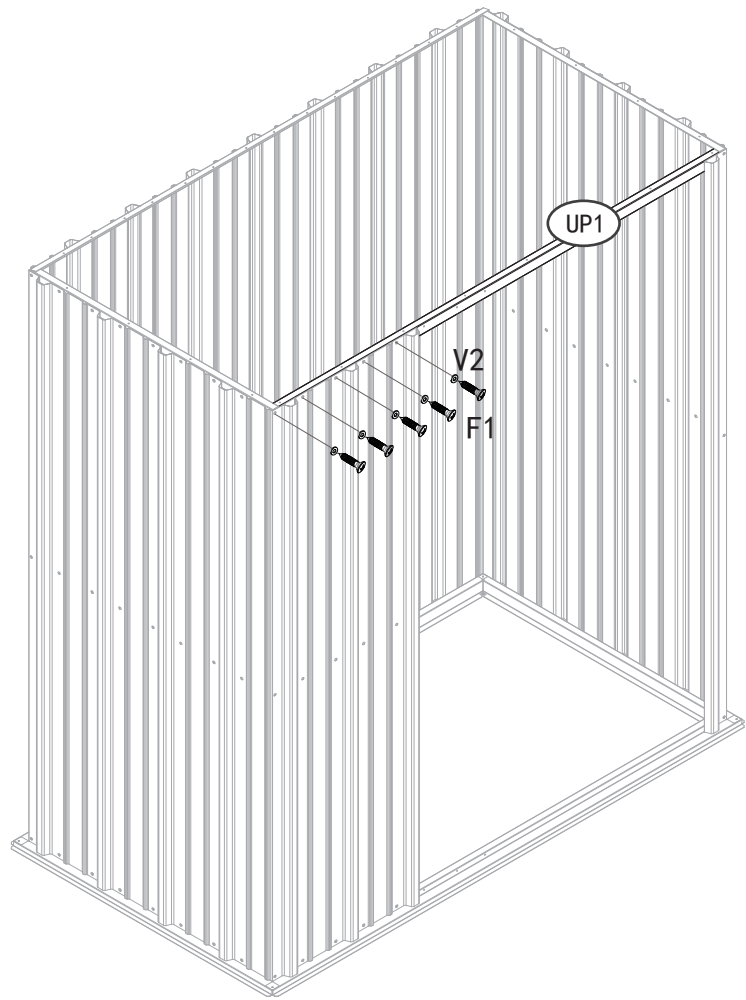



PART	NO.	Qty.
	UP1	1
	F1	5
	V2	5

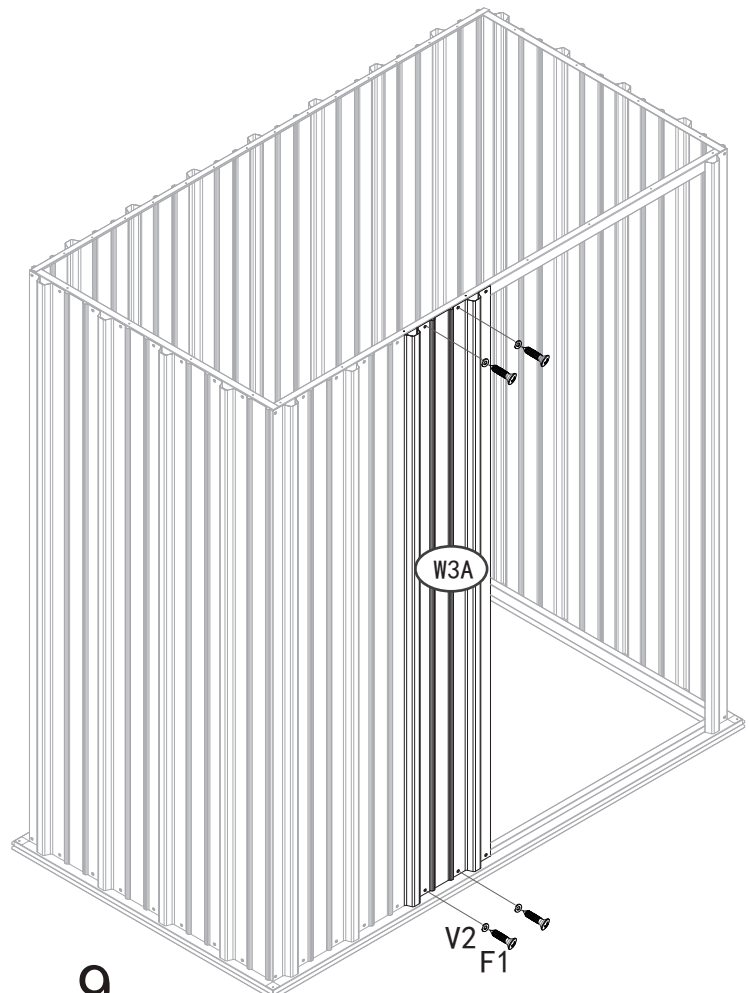

PART	NO.	Qty.
	W3A	1
	F1	4
	V2	4



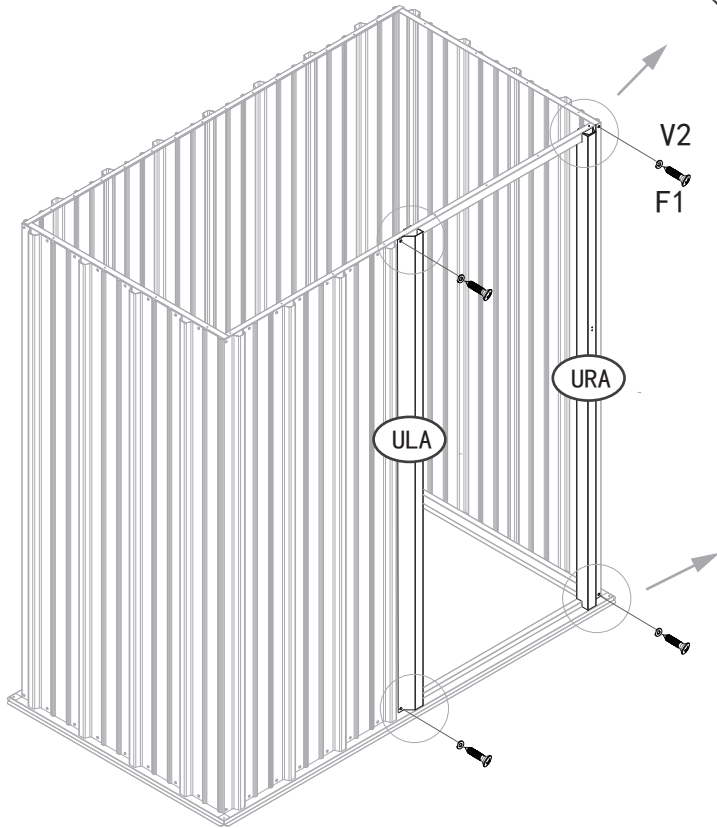
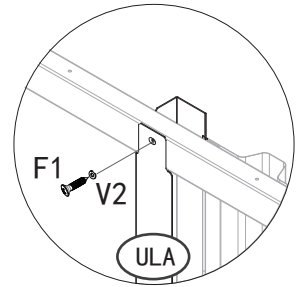
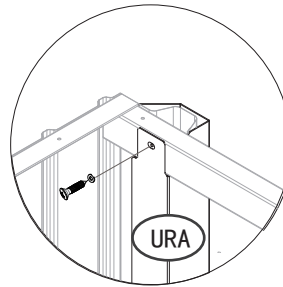

PART	NO.	Qty.
	URA	1
	ULA	1
	F1	8
	V2	8



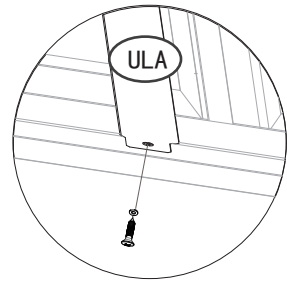
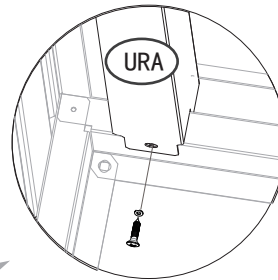



Bitte achten Sie auf die Montageart der Dachpaneele!

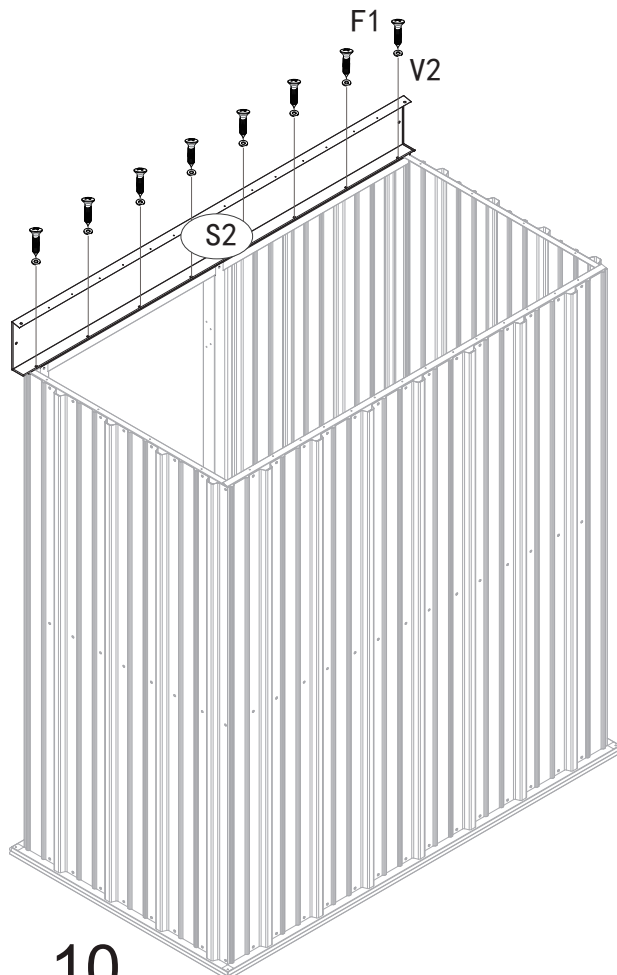





PART	NO.	Qty.
	S2	1
	F1	8
	V2	8

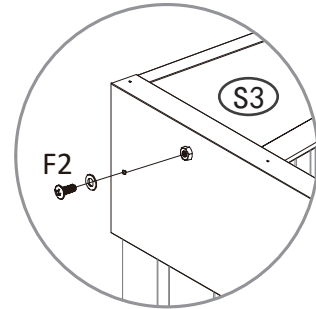
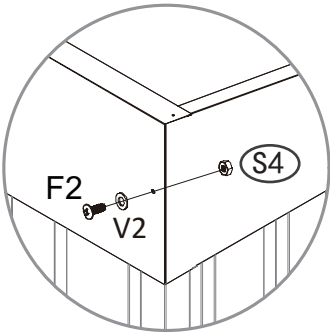
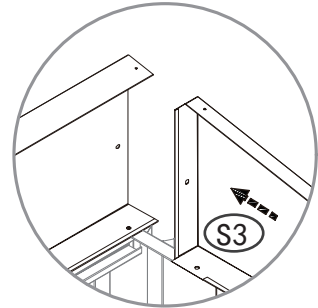
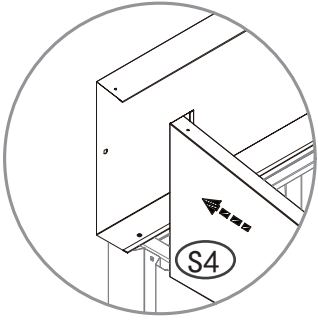
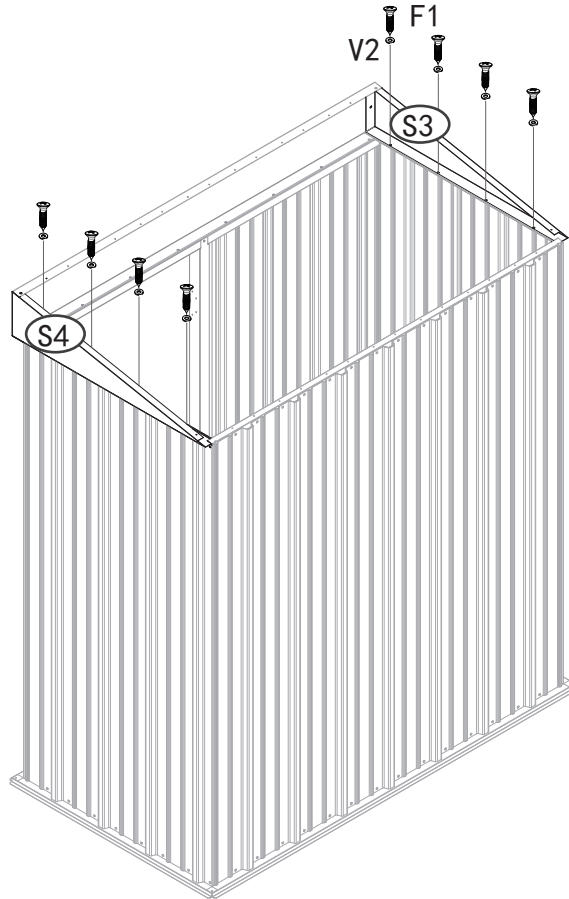

PART	NO.	Qty.
	S3	1
	S4	1
	F1	8
	V2	10
	F2	2



PART	NO.	Qty.
	P1	2
	P2	1
	P3	1
	F1	32
	V2	32

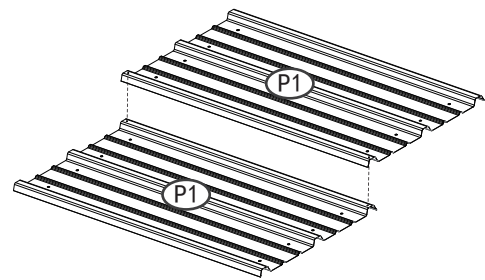
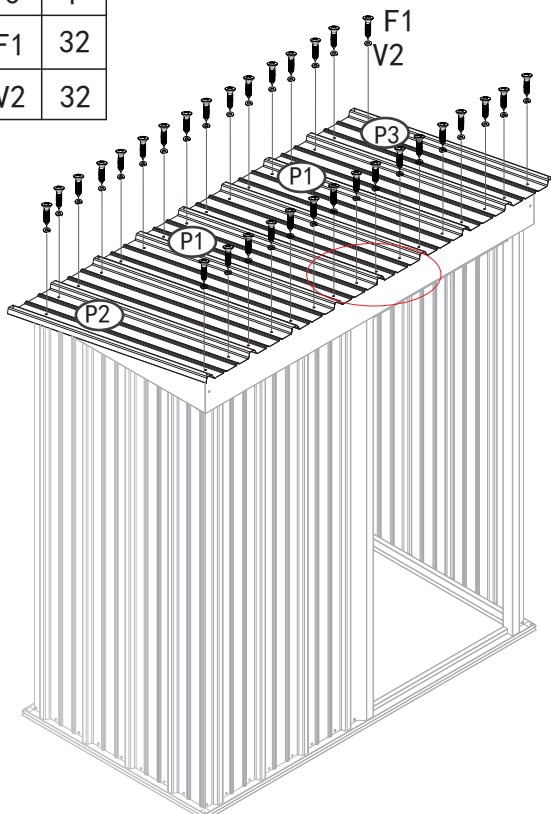

Bitte achten Sie auf die Montageart der Dachpaneele!

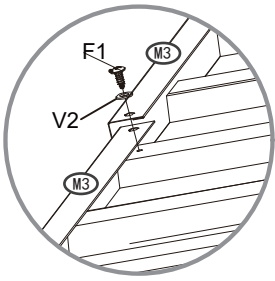



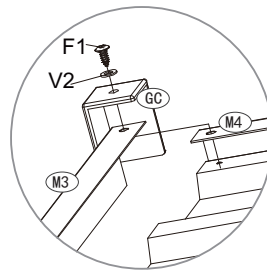

x2

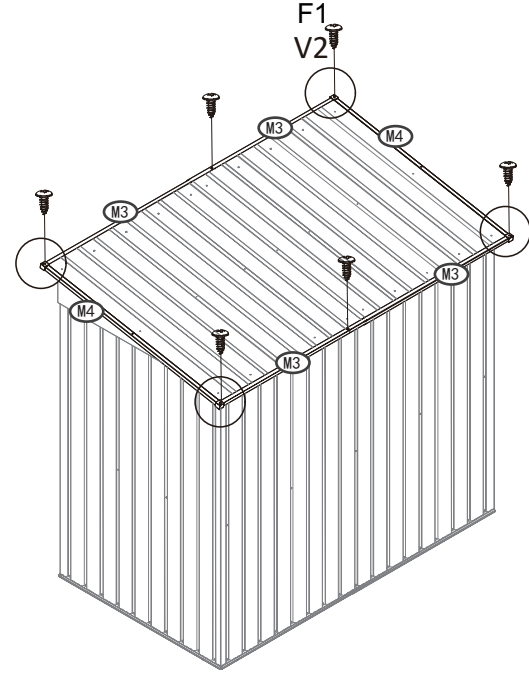
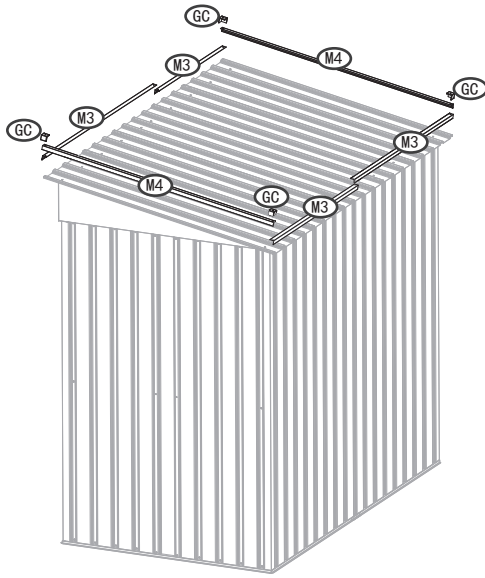





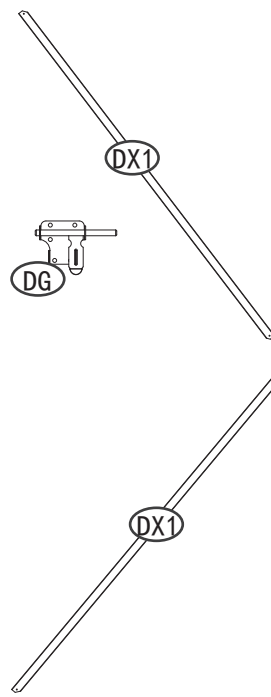
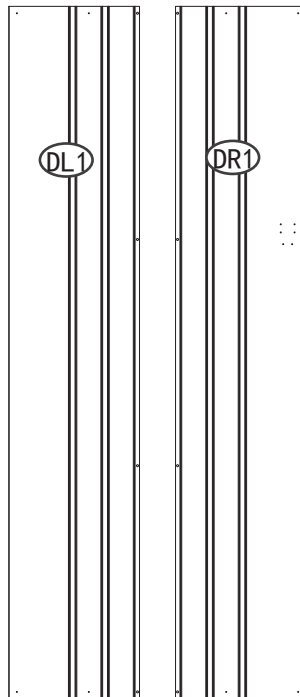

x4





PART	NO.	Qty.
	M3	4
	M4	2
	GC	4
	F1	8
	V2	8

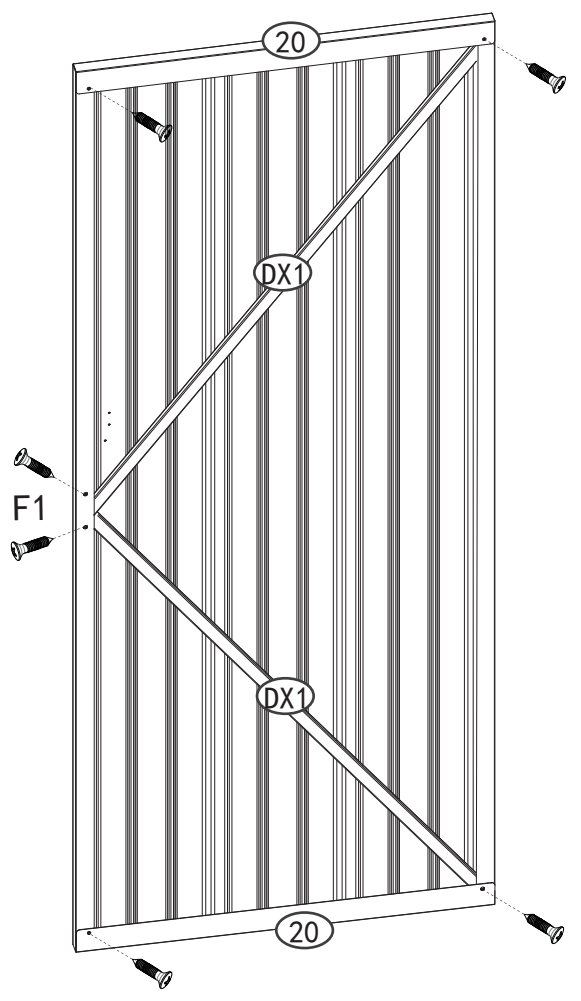
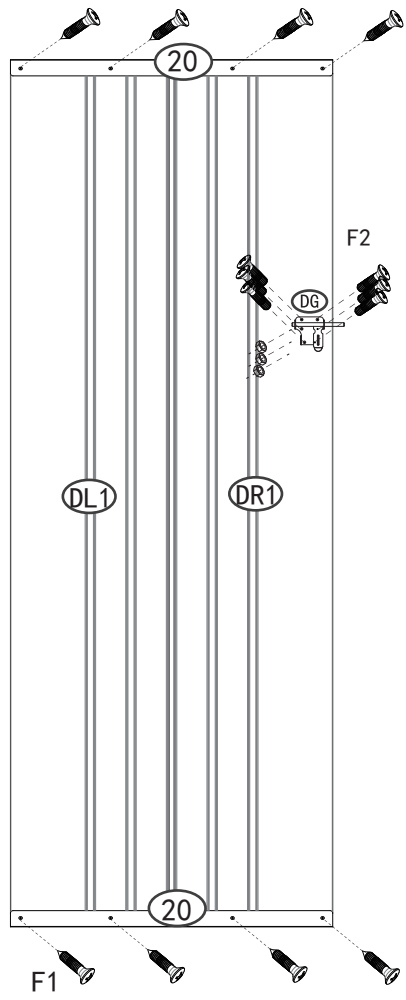

PART	NO.	Qty.
	DX1	2
	20	2
	DL1	1
	DR1	1
	DG	1
	F1	14
	F2	6



PART	NO.	Qty.
	DH	2
	F3	8

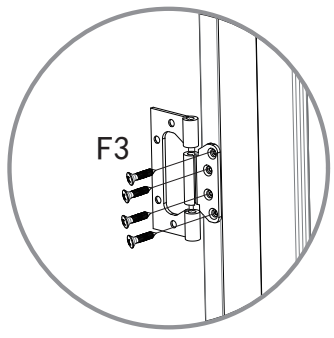
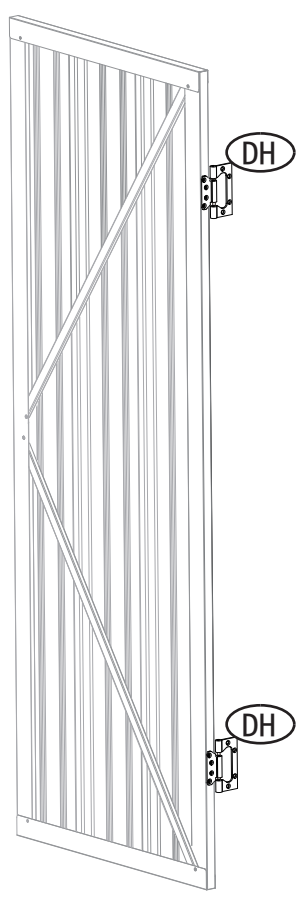



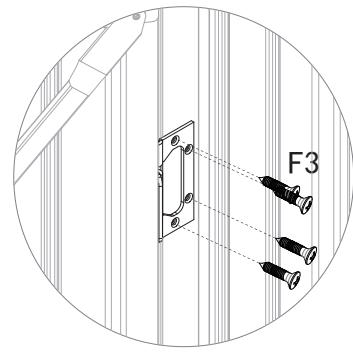
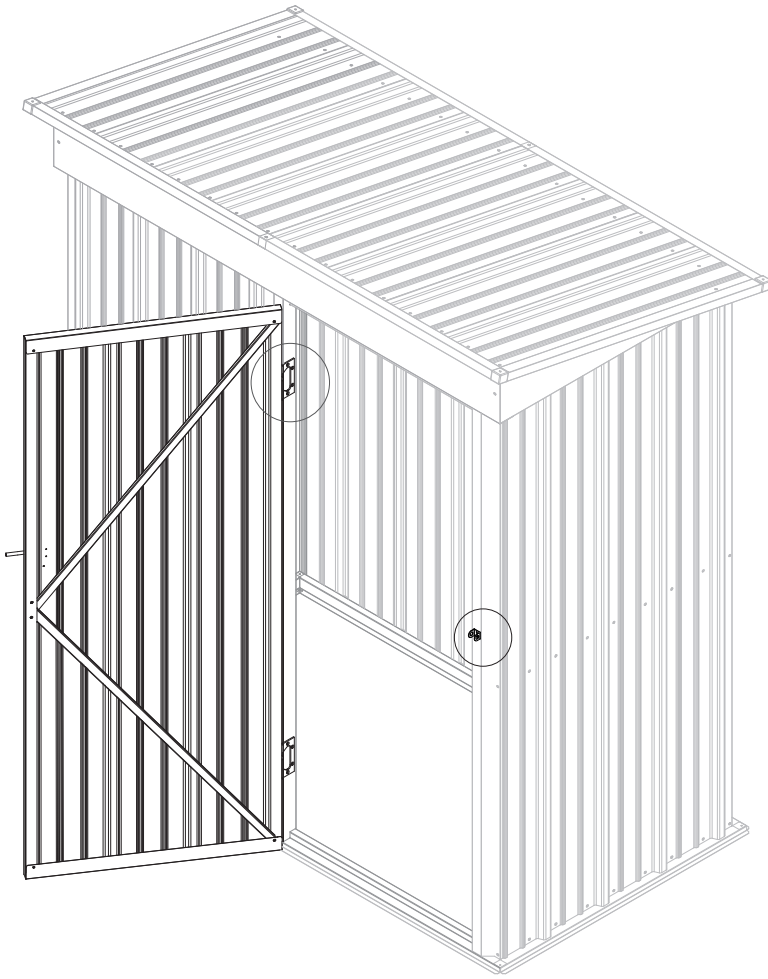

X2

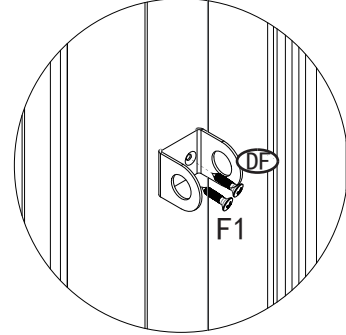

X2



PART	NO.	Qty.
	DF	1
	F3	8
	F1	2

PART	NO.	Qty.
	V1	122

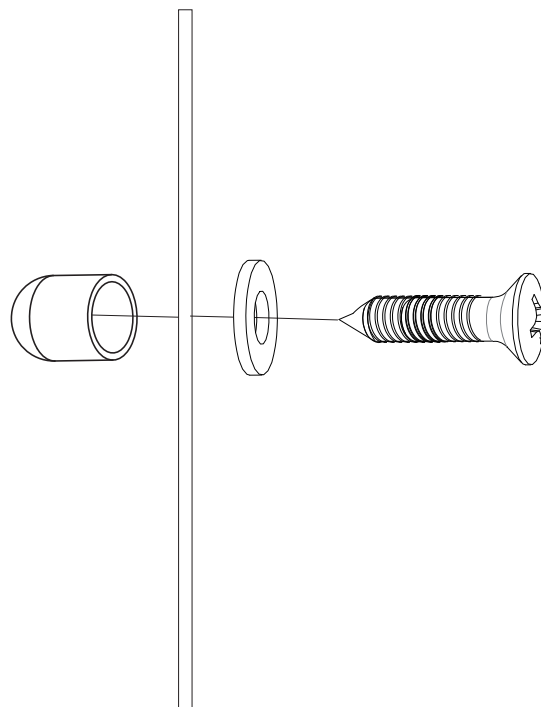

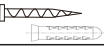
PART	NO.	Qty.
	F6	4

Bitte installieren Sie Dehnschrauben an der Unterseite des Metall-Gartenhauses, um sicherzustellen, dass Ihr Geräteraum starkem Wind und heftigem Regen standhält.

