

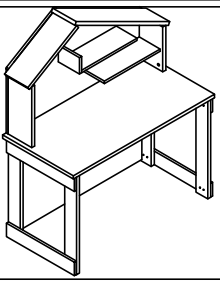







orpak.

GRUP : PİNK HOUSE
GROUP : PİNK HOUSE
ÜRÜN : ÇALIŞMA MASASI
PRODUCT : WORKTABLE
RENK : DOĞAL HUŞ&PEMBE
COLOUR : NATURAL BİRCH&PINK

KOD : 2172
CODE : 2172

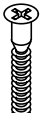
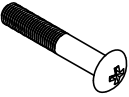

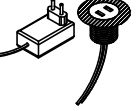
AKSESUAR LİSTESİ / ACCESSORIES LIST

ACCESSORIE NO : 002 TİTUS MİNİFİKS GÖVDE  10 ADET	ACCESSORIE NO : 317 10'LUK MİNİFİKS MİL  10 ADET	ACCESSORIE NO : 004 Ø8x30 KAVELA  19 ADET	ACCESSORIE NO : 091 KABİN VİDASI (50mm)  5 ADET	ACCESSORIE NO : 107 M6*35 VİDA  16 ADET
	ACCESSORIE NO : 106 3*16 MM S. VİDASI  2 ADET	ACCESSORIE NO : 575 USB APARATI ÇAP 28 MM BEYAZ  1 ADET	ACCESSORIE NO : 096 4*40 MM S. VİDASI  11 ADET	ACCESSORIE NO : 020 MİNİFİKS TAPA BEYAZ  6 ADET

YEDEK AKSESUAR SİPARİŞLERİNİ RESME BAKARAK VERİNİZ. (Örn:ACCESSORIE.NO:008 - RAFİKS MİL - 1 Ad.)
PLEASE ORDER THE ACCESSORIES ACCORDING TO THE REFERENCE NUMBER ON THE DRAWING(EXAMPLE ACCESSORIE NO-008 RAFİKS MİL 1.PCS.)

orpak.

PARÇA LİSTESİ PARTS LIST

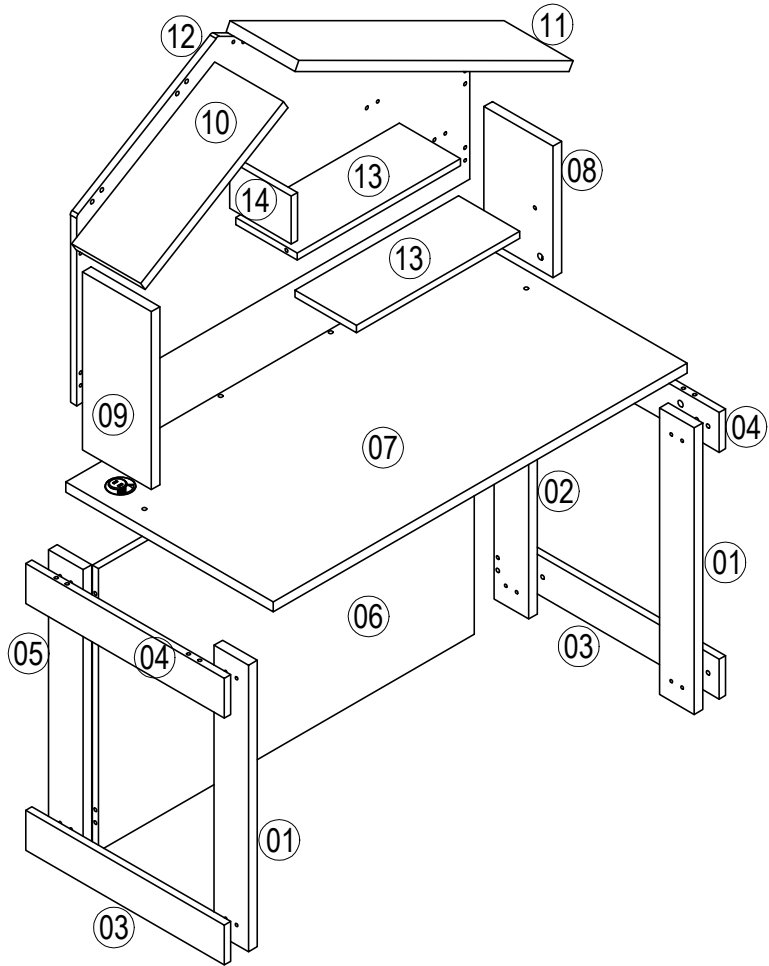

FR-002

NO	ADET/PCS	NO	ADET/PCS	NO	ADET/PCS
01	2	11	1		
02	1	12	1		
03	2	13	2		
04	2	14	1		
05	1				
06	1				
07	1				
08	1				
09	1				
10	1				

YEDEK PARÇA SİPARİŞLERİNİ RESME BAKARAK PARÇA NUMARASINA GÖRE VERİNİZ
PLEASE ORDER THE SPARE PARTS ACCORDING TO THE REFERENCE NUMBER ON THE DRAWING

