

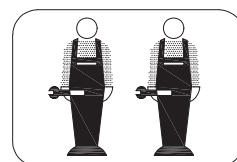

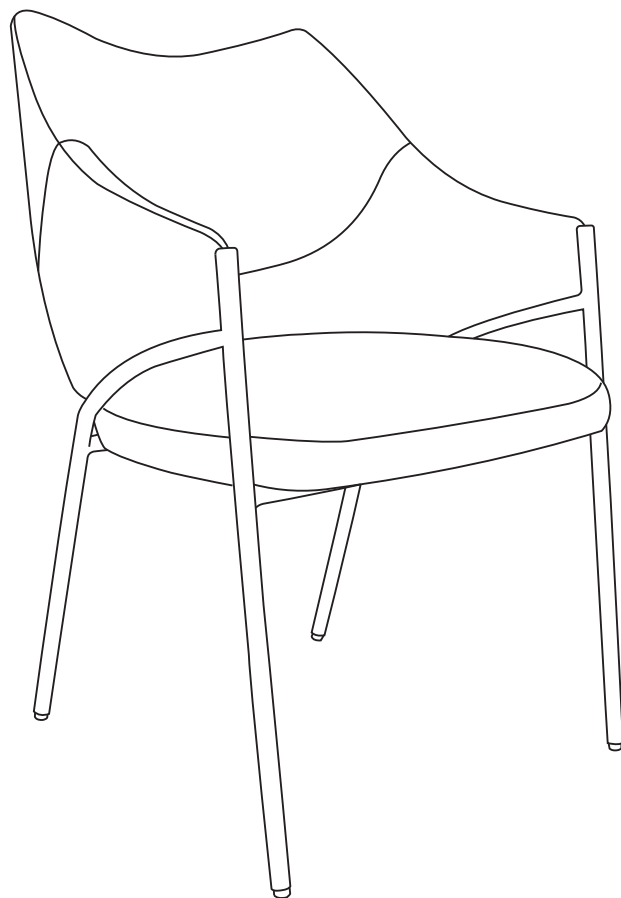

# ASSEMBLY INSTRUCTIONS MONTAGEANLEITUNGEN

WF320986



 M6×12mm	 M6×18mm	 M6×25mm	
Ⓐ ×2pcs	Ⓑ ×6pcs	Ⓒ ×4pcs	Ⓓ ×1pcs

Bitte beachten Sie, dass die Formen der Schrauben A und B ähnlich sind. Bitte installieren Sie entsprechend der Anleitung und unterscheiden Sie sie!

Please note that the shapes of screws A and B are similar. Please install according to the instructions and distinguish them!

Notez que les vis A et B ont des formes similaires. Veuillez les installer en suivant les instructions pour les séparer!



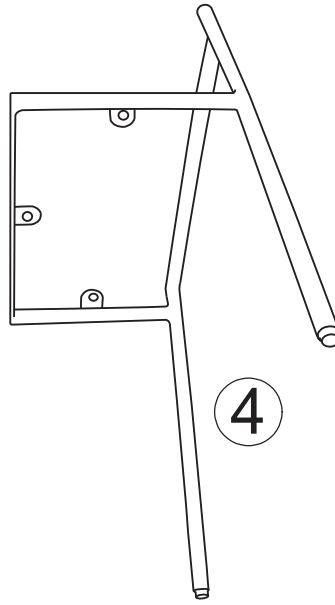
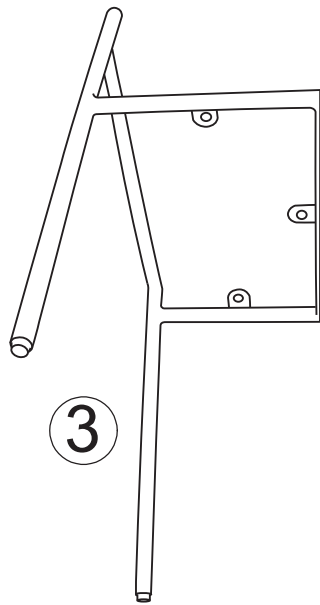
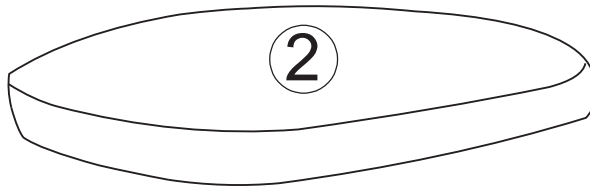
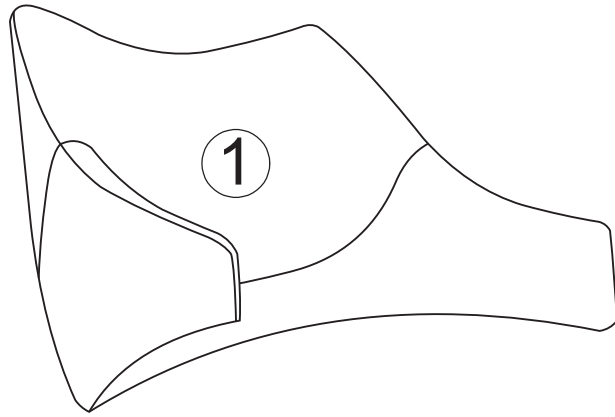

Vor dem Einbau die Schrauben in die Löcher stecken und festziehen, aber nicht bis 100%, 70% bis 80% anziehen reicht aus. Schließlich, nachdem alle Schrauben installiert sind, ziehen Sie alle Schrauben auf 100%. Wenn Sie auf diese Probleme stoßen, z.B. wenn die Löcher nicht ausgerichtet werden können oder einige Teile nicht installiert werden können, überprüfen Sie bitte, ob die Schrauben korrekt verwendet werden und passen Sie die Dichtheit der Schrauben an.

Before installation, insert the screws into the holes and tighten them, but do not tighten them to 100%, 70% to 80% is sufficient. Finally, after all screws are installed, tighten all screws to 100%. If you encounter these issues, such as if the holes cannot be aligned or some parts cannot be installed, please check if the screws are used correctly and adjust the tightness of the screws.





Insérer la vis dans le trou avant la fin de l'assemblage, serrer la vis, mais ne pas serrer à 100%, 70% ~ 80% est correct. Enfin, une fois que toutes les vis sont bien serrées, toutes les vis sont serrées à 100%. Si vous rencontrez ces problèmes, par exemple si les trous ne sont pas alignés ou si certaines pièces ne peuvent pas être montées, vérifiez que les vis sont utilisées correctement et Ajustez leur serrage.



Part List  
Stückliste

			
①×1pc	②×1pcs	③×1pcs	④×1pcs



Hardware List  
Hardwareliste

			
M6×12mm	M6×18mm	M6×25mm	
Ⓐ×2pcs	Ⓑ×6pcs	Ⓒ×4pcs	Ⓓ×1pcs

Step 1  
Schritt 1

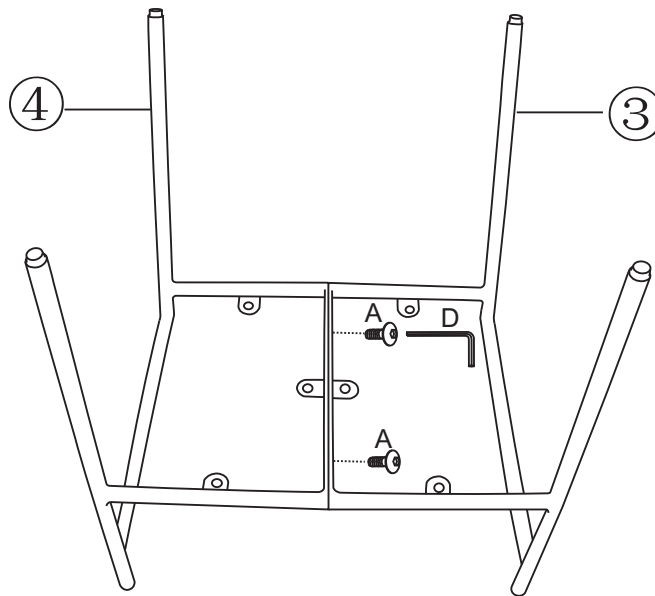
  
M6x12mm  
Ⓐ ×2pcs





 M6x12mm  
 M6x18mm  
 M6x25mm  
A B C

Step 2  
Schritt 2

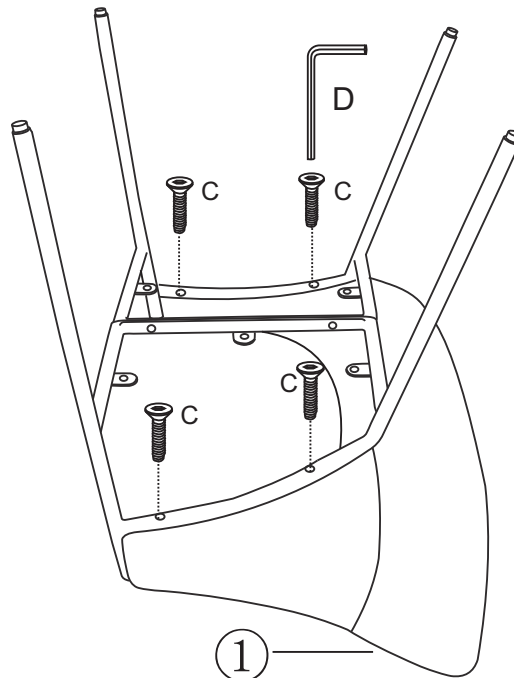
  
M6x25mm  
Ⓒ ×4pcs



 M6x12mm  
 M6x18mm  
 M6x25mm  
A B C

### Step 3 Schritt 3



M6×18mm

ⓑ×6pcs

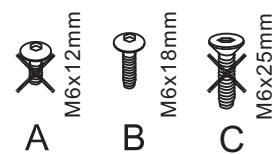
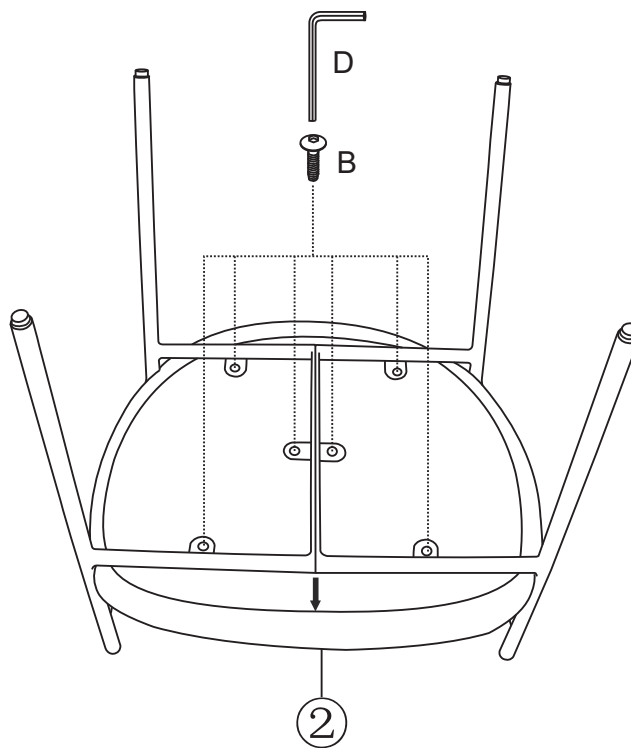

### Step 4 Schritt 4

