

D

C

B

A

4

4

# A - A

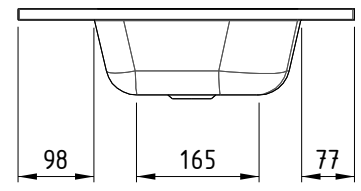
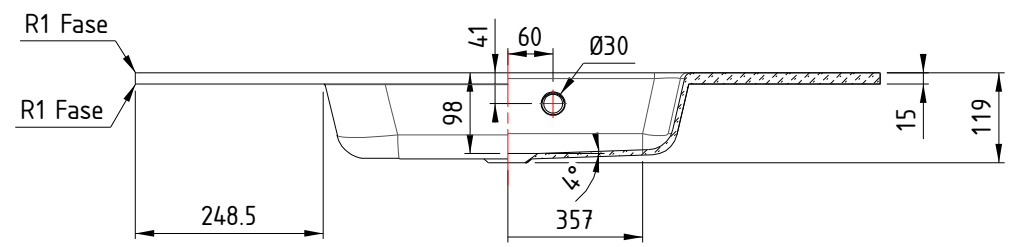

3

3

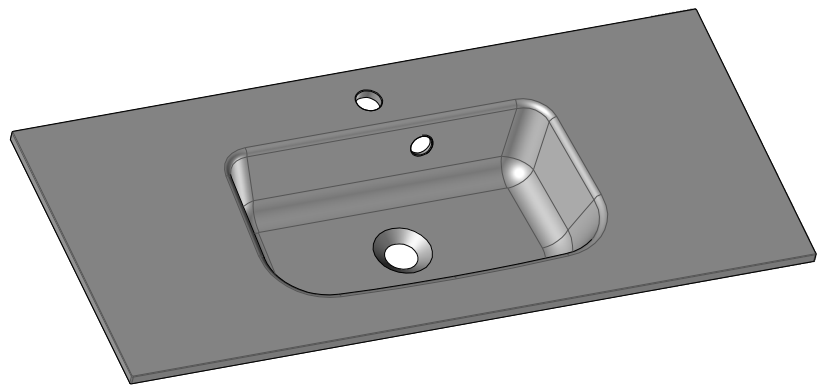
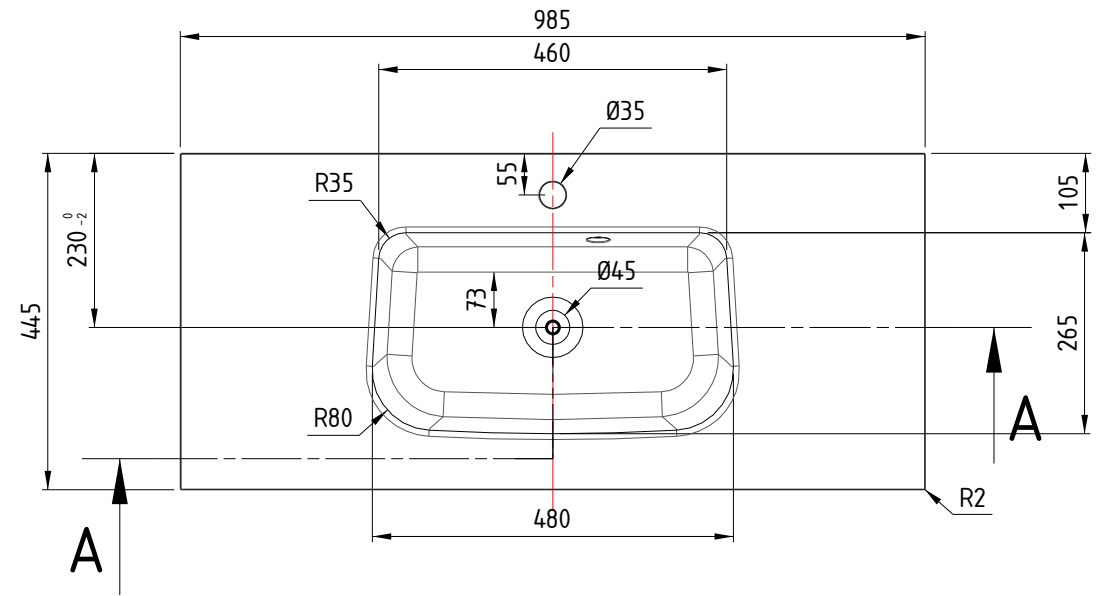

2

2

Material: <b>Glass</b>	Mass: <b>0.0kg</b>	General Tolerances: -	<b>Version 2</b>		
Coating:		General Surface Finish: -			
Description: <b>WFS-990</b>		Author: -	<b>A4</b>		
Part Number: <b>980.789.904</b>		Date: <b>2015/04/26</b>			
			Scl <b>1:10</b>	Rev <b>A</b>	Folio <b>1/1</b>

1

1

D

A

# pelipal

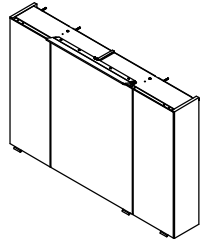

MOT-NZ0942S1 A4  
Datum 30/04/19

## 045-\_\_-1553

T1 Bitte unbedingt ausfüllen!

Name -----  
Strasse -----  
PLZ ----- Ort -----  
Tel. -----

T2 Sehr geehrte Kunden,  
wir freuen uns, dass Sie sich für ein Produkt aus dem Hause Pelipal entschieden haben. Sollte es trotz aller Bemühungen unsererseits, Ihnen ein qualitativ hochwertiges Möbelstück zu liefern, zu Fehlteilen kommen, schicken Sie bitte dieses ausgefüllte Blatt an

Fax.: +49 3443/434350

E-Mail: [ersatzteile@pelipal.de](mailto:ersatzteile@pelipal.de)

Bitte beachten Sie, dass Bauteile über 800mm Länge und 350mm Breite direkt bei Ihrem Möbelhändler zu beanstanden sind. Zur Reklamationsbearbeitung ist es unbedingt erforderlich **die Artikelnummer des Schrankes**, welche auf dem Etikett ersichtlich ist und den Markt, wo das Möbel erworben wurde anzugeben. Außerdem tragen Sie unten bitte die benötigte Stückzahl ein. Viel Spaß mit Ihrem neuen Badmöbel!

Ihr Pelipal Team

-----

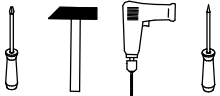

T3 Für den Zusammenbau sind 2 Personen erforderlich.

T4 Montage-Richtzeit 3 Stunden

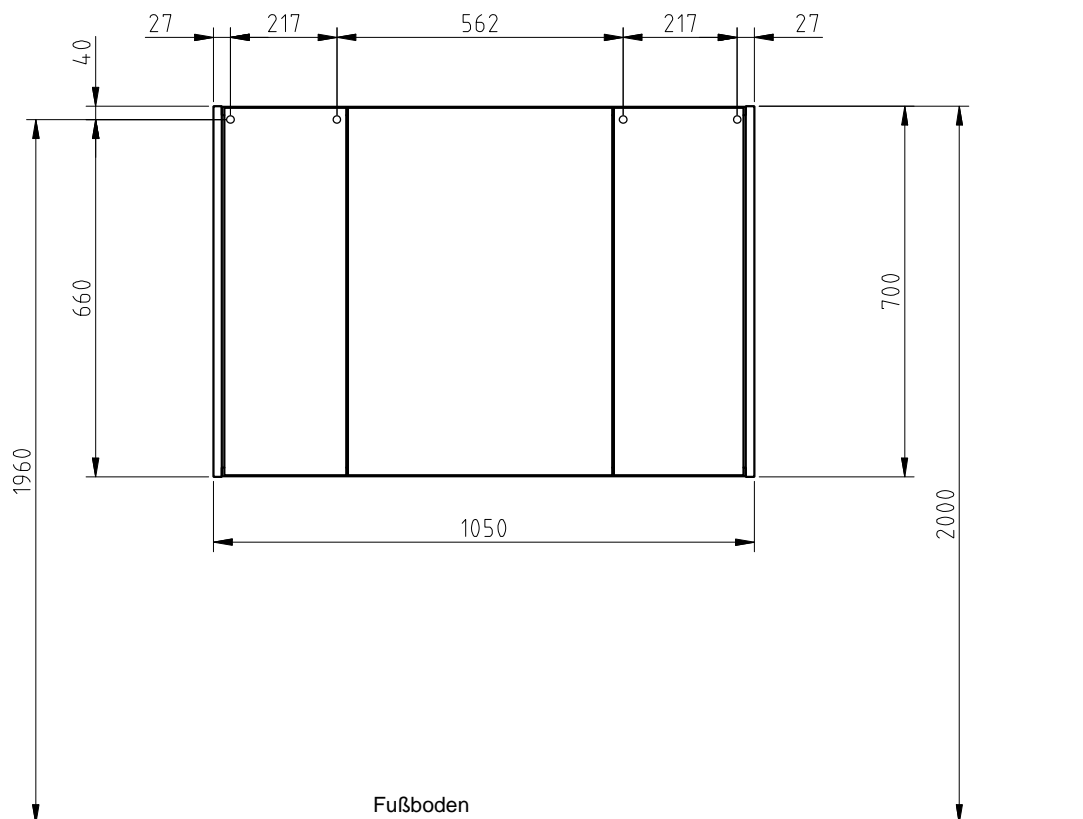

Die Maßangabe der Höhe ist nicht bindend!

7 x a  ZPL-003X004	Stück	7 x b  TBD-35-115X08	Stück	20 x c  SCH-SPA-035X015	Stück	12 x d  DUEB-SMD-000005	Stück	12 x e  EXZENTER-000015	Stück
2 x f  AUF-001-000090	Stück	2 x g  AUF-001-000080	Stück	4 x h  AUF-001-000020	Stück	7 x i  ADK-WE1-010X013	Stück	24 x j  TRAE-001-000020	Stück
20 x k  NAGEL-025X001	Stück	3 x l  TUER-DAEM-000010	Stück	3 x m  TUER-ADA-000010	Stück	3 x n  GRI-032-606033	Stück	6 x o  SCH-SPA-025X020	Stück
1 x p  TRA-M00-DE			Stück	2 x q  SCH-SON-063X050	Stück	2 x r  ADK-WE1-012X003	Stück	1 x s  ELE-ZUB-000010	Stück
8 x t  DTS-15X2X4,9	Stück	8 x u  SCH-RWD-030X025	Stück	4 x v  SCH-SON-063X050	Stück	2 x w  ADK-WE1-012X003	Stück	2 x x  ADK-WE1-005X008	Stück
1 x y  LEU-LED-000140			Stück	4 x z  SCH-RDK-040X015	Stück	11 x φ  ADK-BES-WE0010	Stück	1 x λ  KAB-000095	Stück
1 x ξ  VBD-000020	Stück	1 x π  SCH-RDK-040X015	Stück	1 x β  SCH-RDK-045X045	Stück	2 x α  ADK-WE1-014SK	Stück		Stück

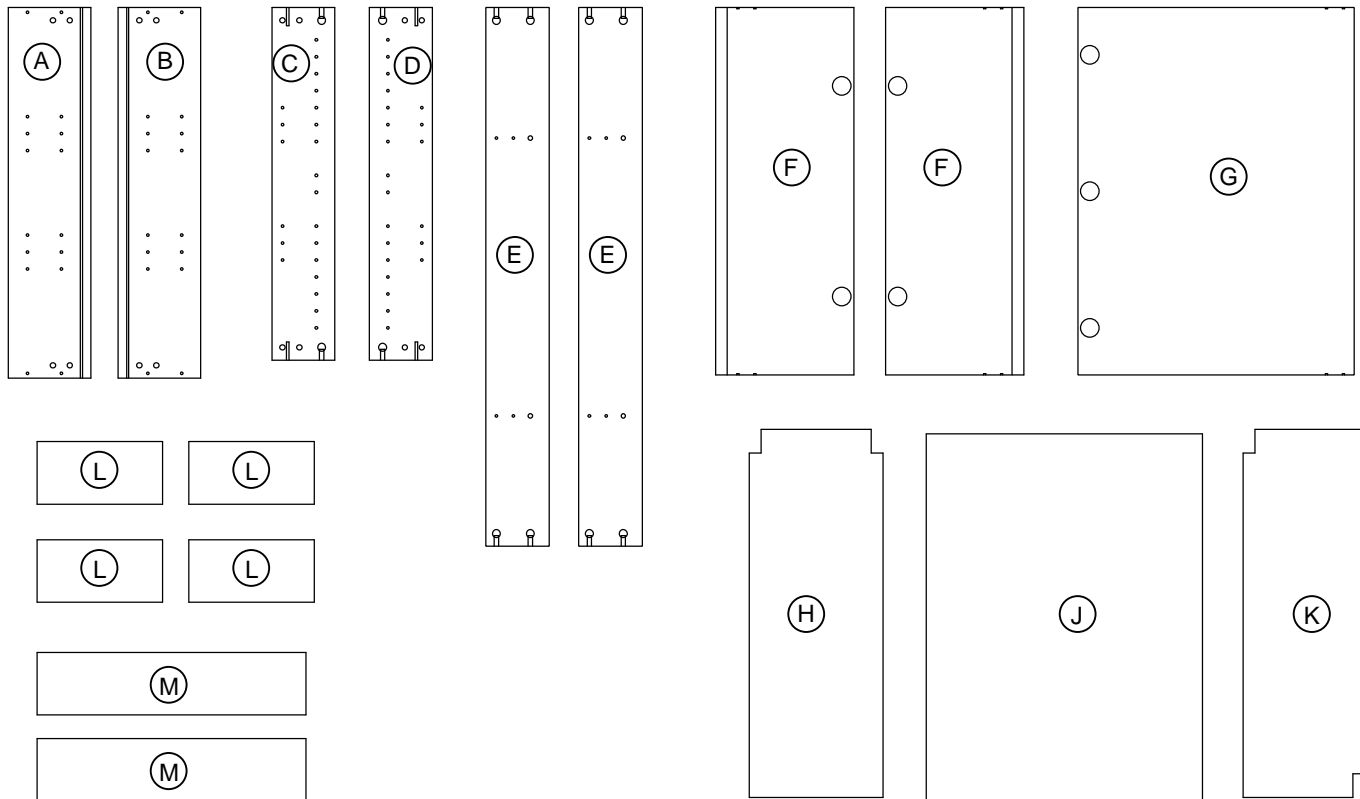

1.

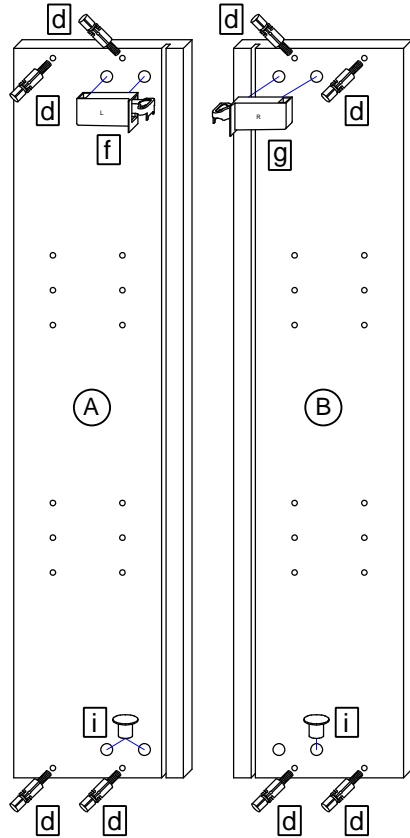
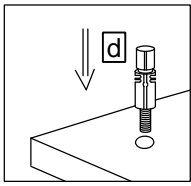
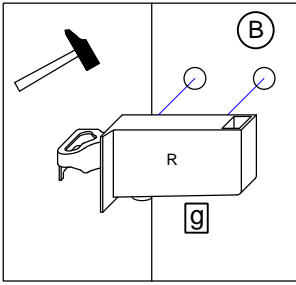
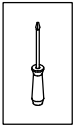

2.

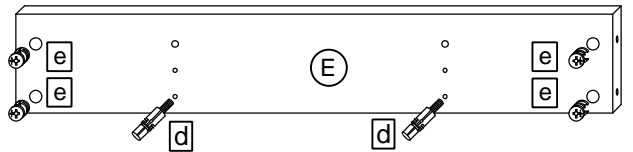
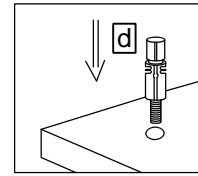
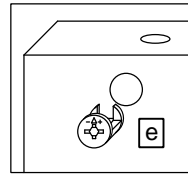
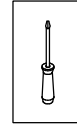

3.

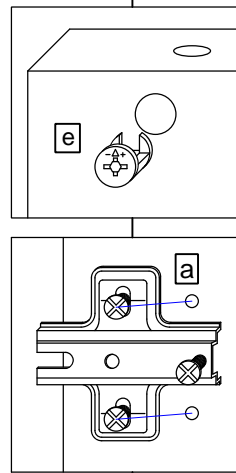
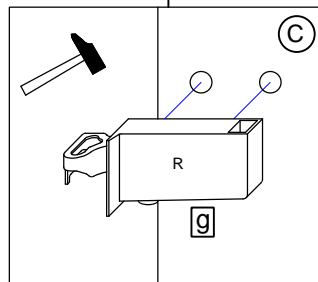
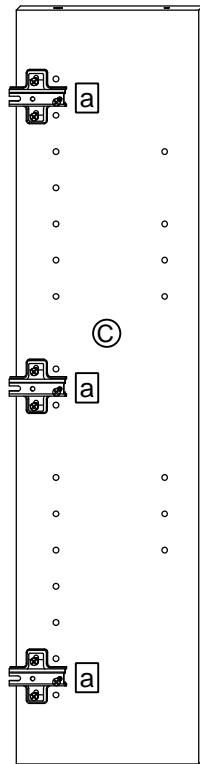
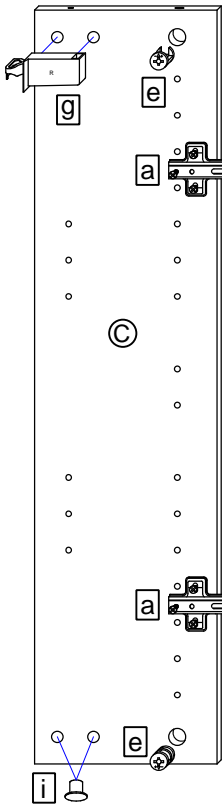
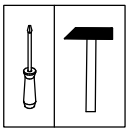

4.

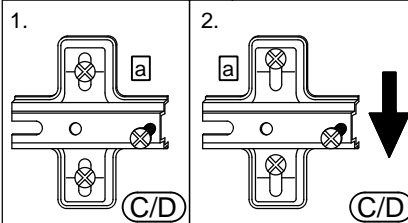
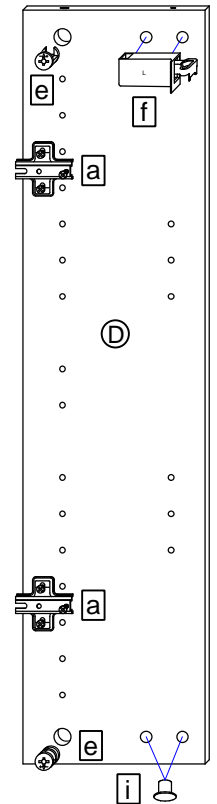
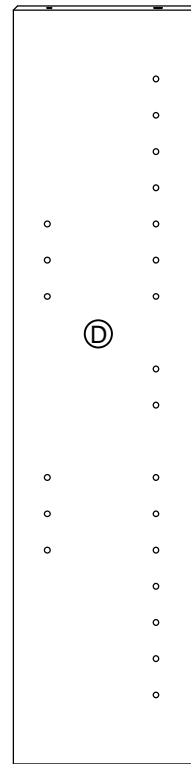
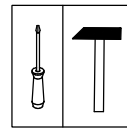

5.

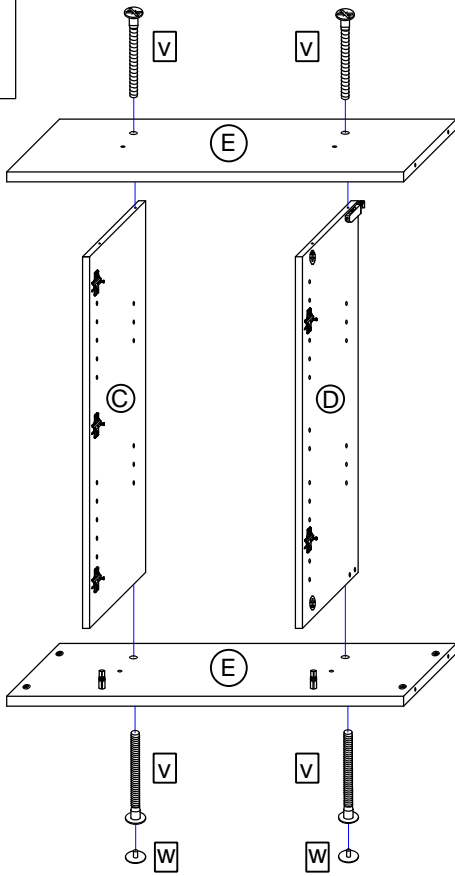
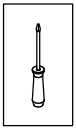

6.

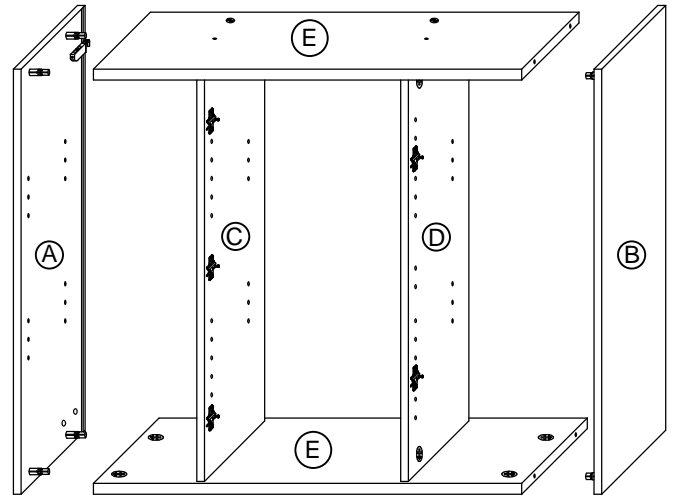
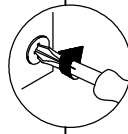
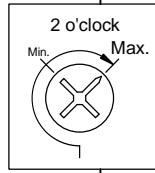
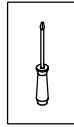

7.

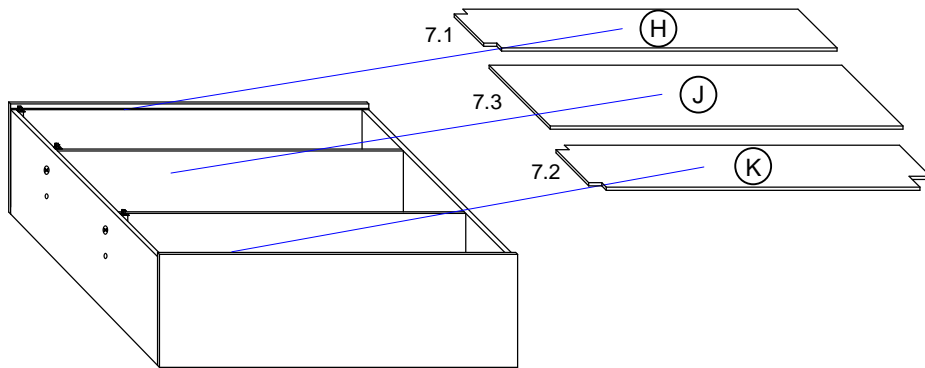

8.

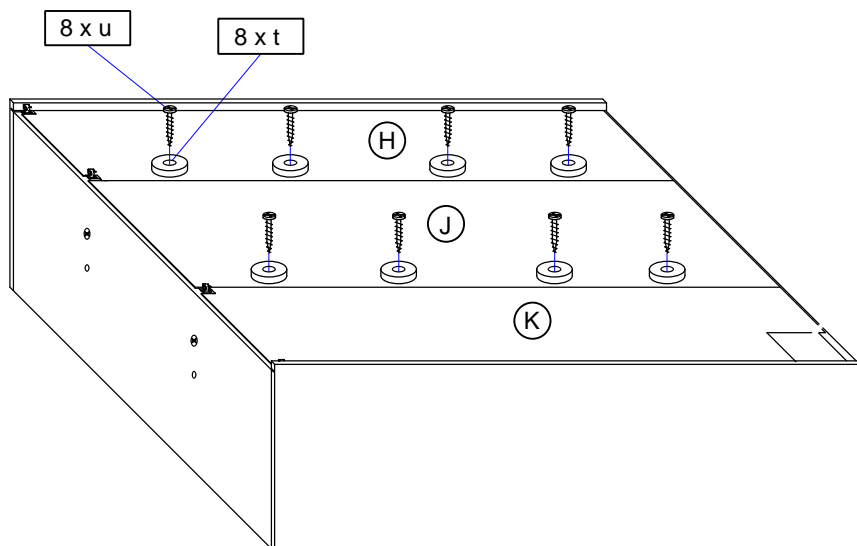
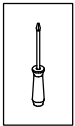

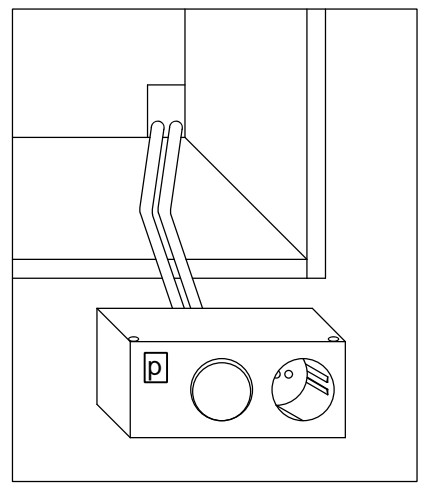
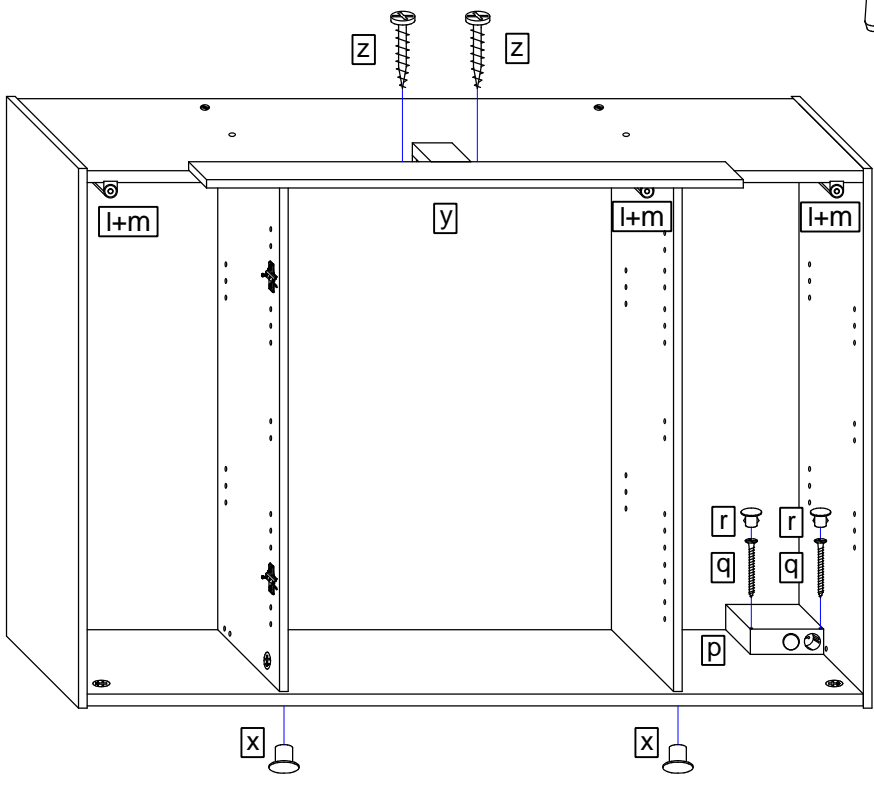
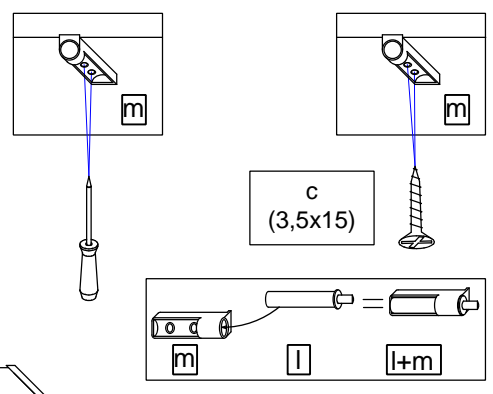
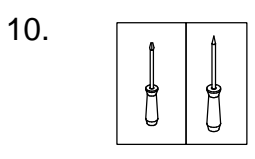
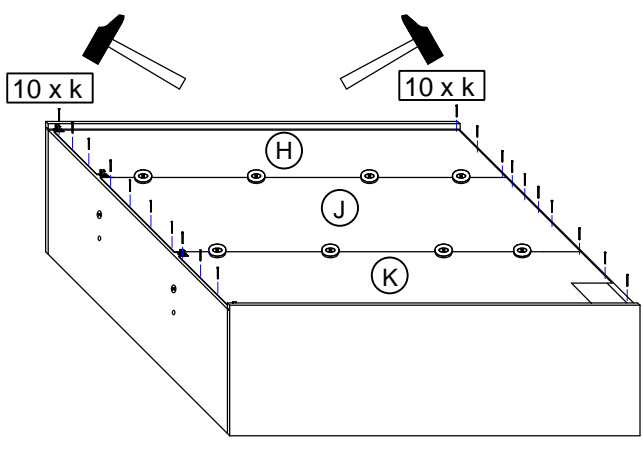
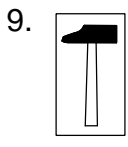

11.

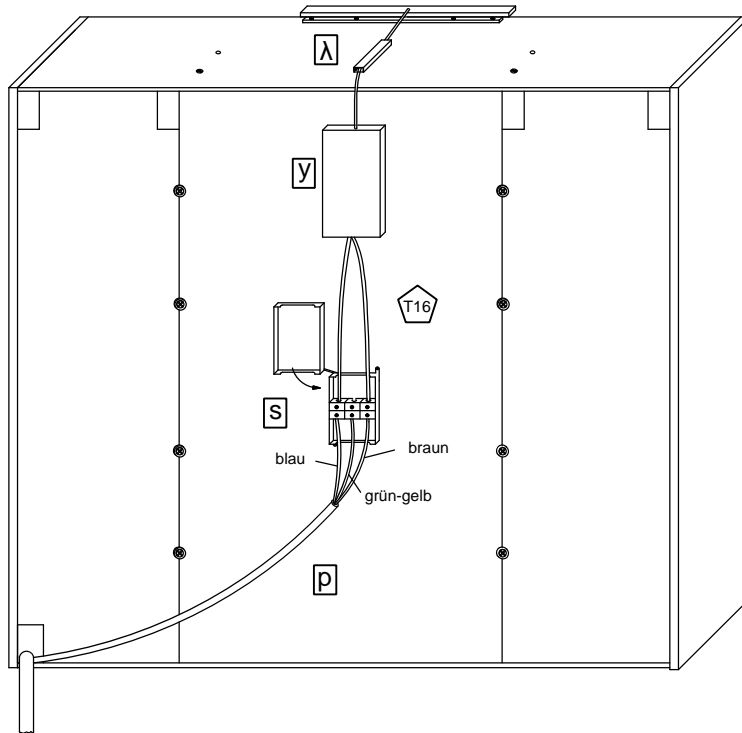
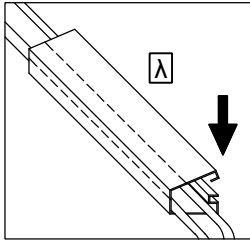

T16 ANSCHLUSSDOSE

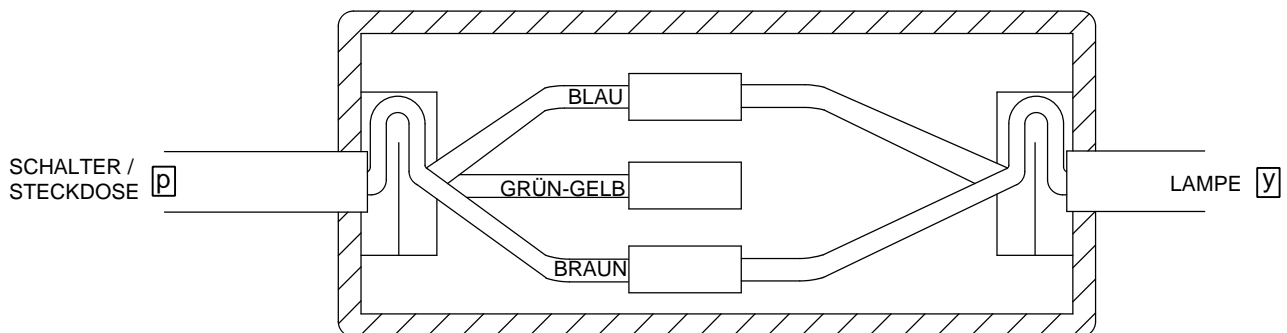

Spiegelschrank

Hausnetz

**T32** Achtung! Der Netzanschluss muss in einer Anschlussdose erfolgen.

**T33** Der Elektroanschluss des Schrankes ist unter Berücksichtigung der **VDE 0100 Teil 701** von einem Elektrofachmann durchzuführen!

<b>T36</b>	Internationale Norm	IEC 60364-7-701
	Europannorm	CENELEC HD 384
	Frankreich	NFC 15-100
	UK	BS 7671
	Belgien	AREI / RGIE
	Spanien	REBT
	Italien	CEI 64-8
	Niederlande	NN1010

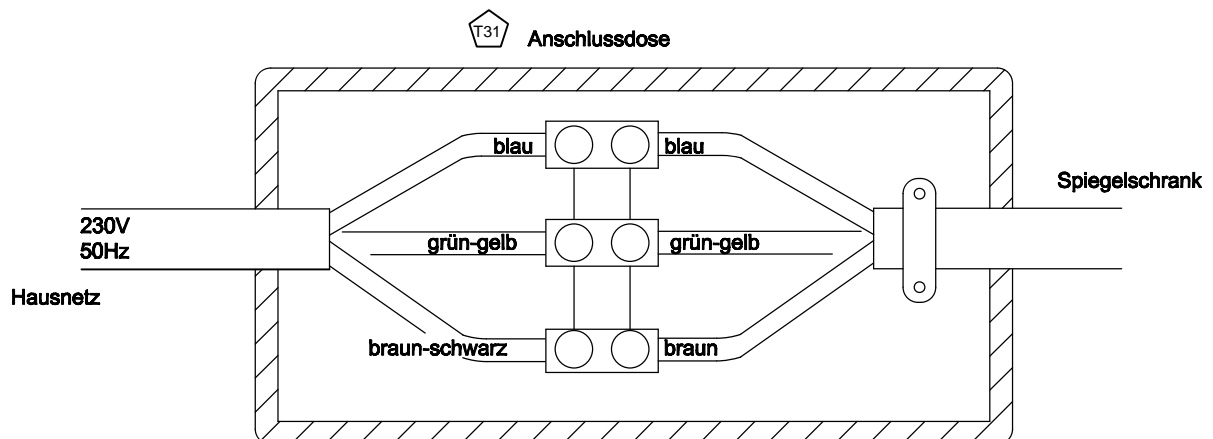



12.

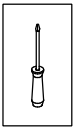

- T37** Achtung! Bei fehlerhafter Montage können Schäden durch das Herabstürzen des Schrankes entstehen.
- T9** Lassen Sie den Schrank nur durch fachkundige Personen mit für die Wand geeignetem Montagematerialien montieren.
- T38** Achten Sie beim Aufhängen des Schrankes darauf, dass der Schrankaufhänger richtig in den Schraubhaken einrastet.

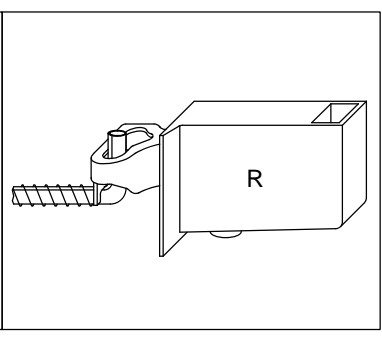
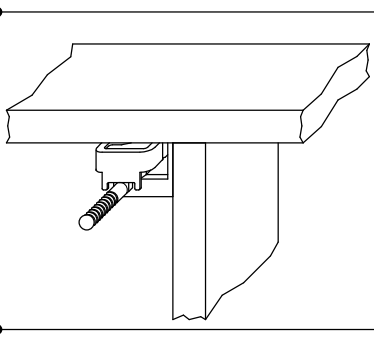
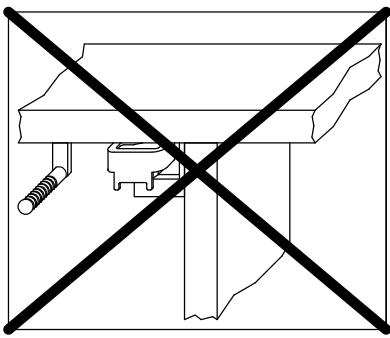
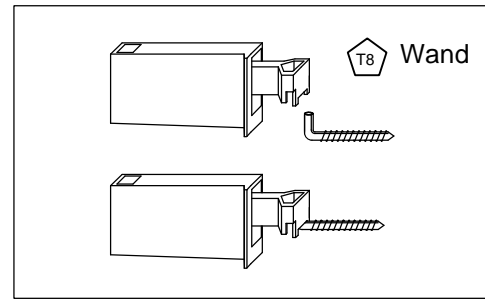
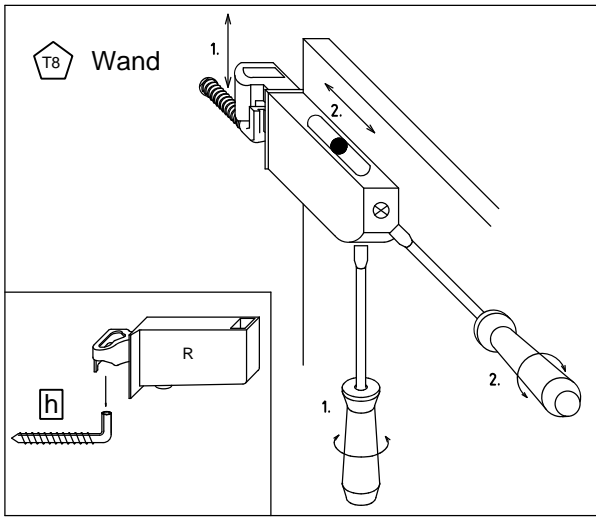
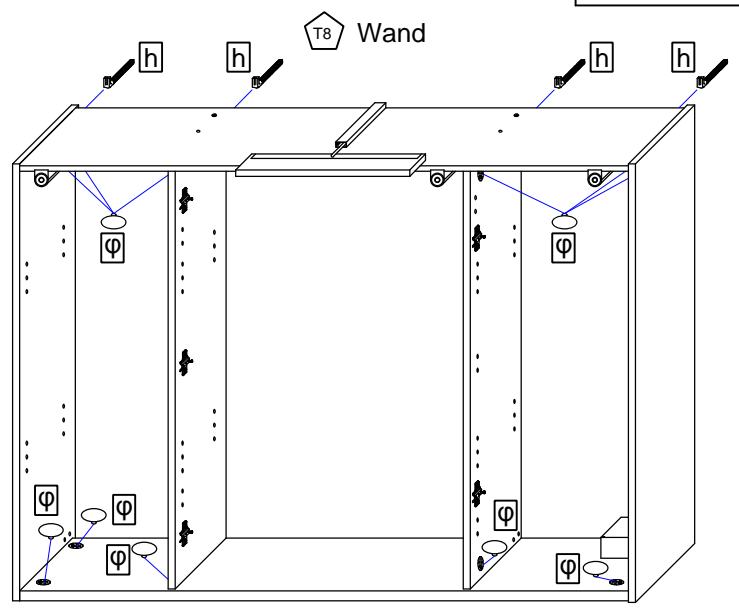

13.

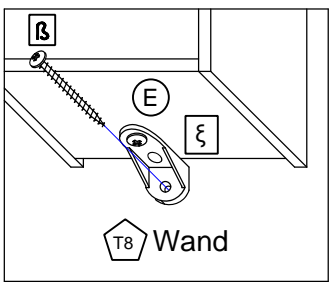
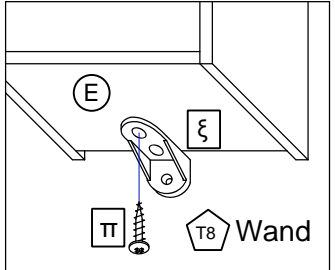
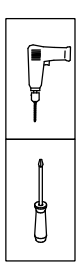

14.

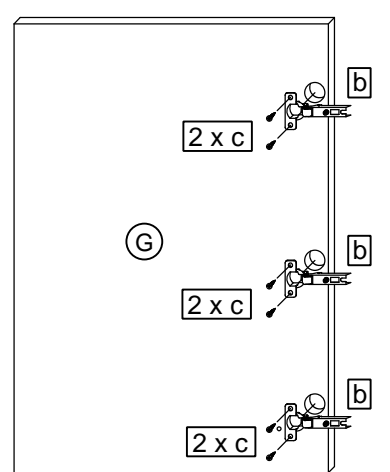
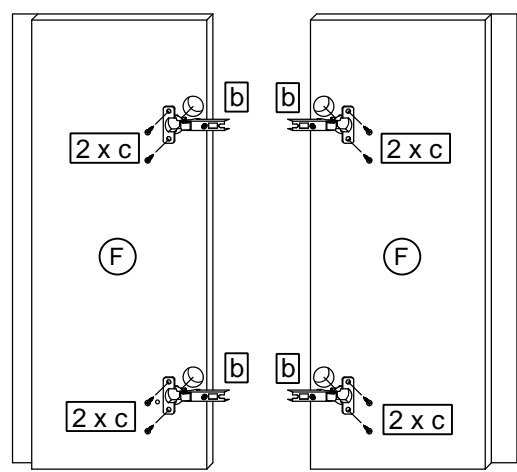
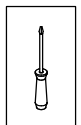

15.

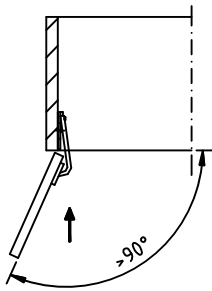
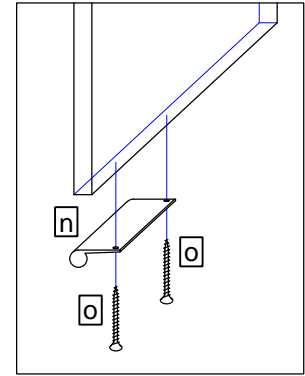
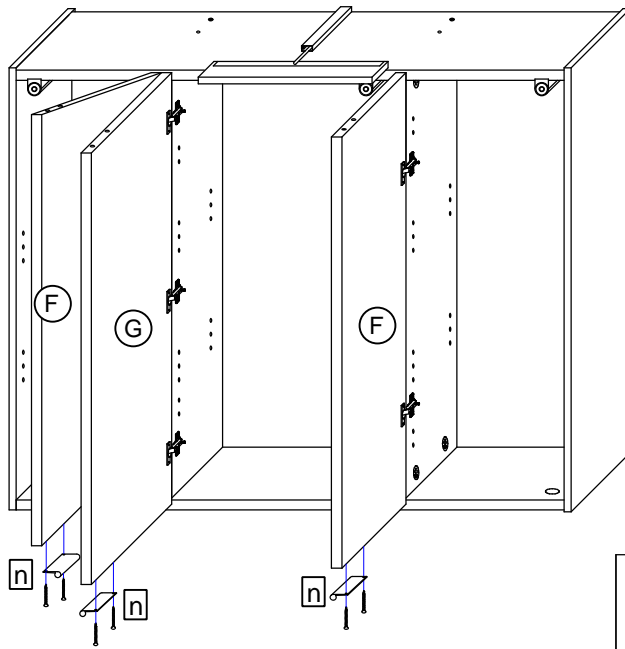
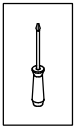
MOT-NZ0942S9 A4  
Datum 30/04/19

T11

Bei Türmontage das Scharnier einhängen, bis Anschlag öffnen und anschließend festschrauben.

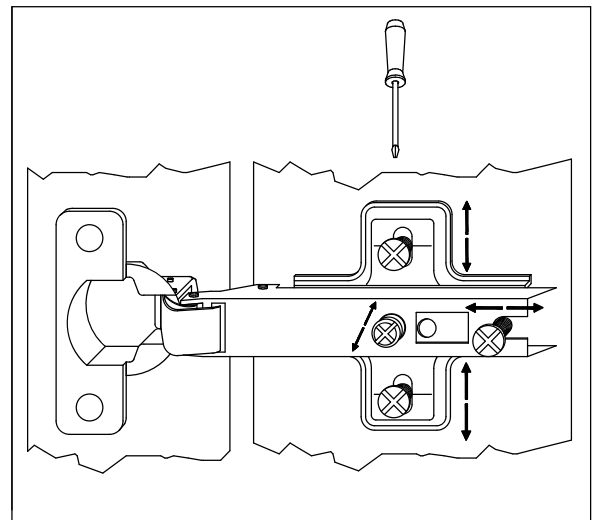

16.

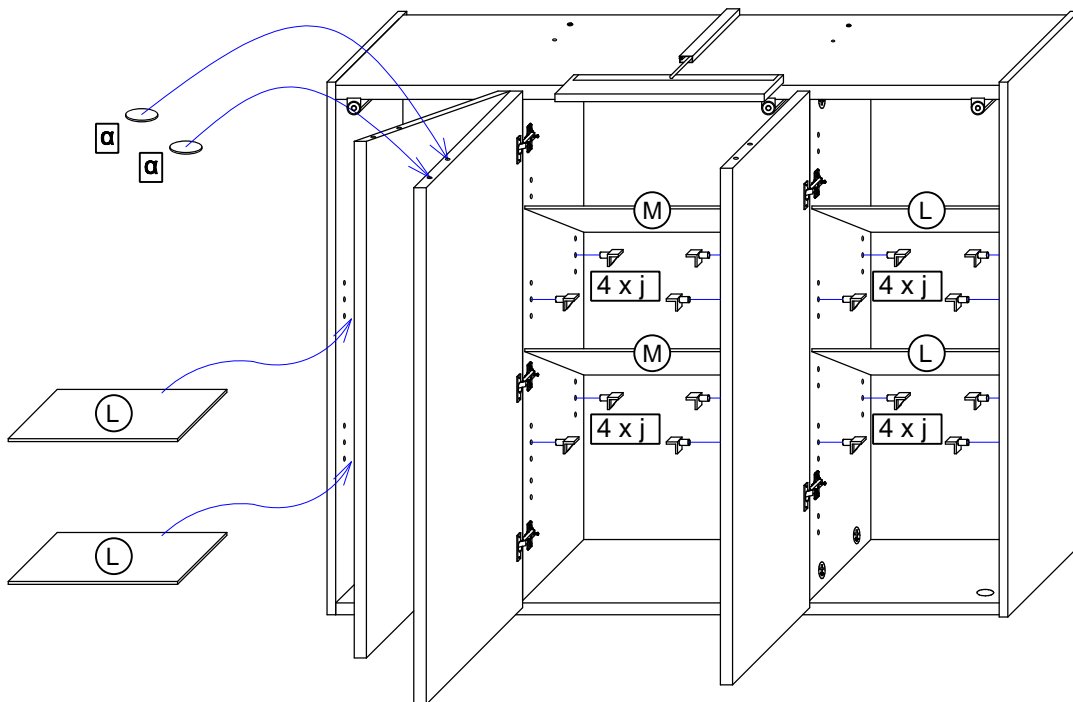

T39

Zur Reinigung der Spiegel benutzen Sie bitte keine harten und scharfen Gegenstände, da dadurch die Spiegel zerkratzt werden können.

T40

Bitte haben Sie dafür Verständnis, dass wir für Schäden, die durch unsachgemäße Aufhängung oder elektrische Installation hervorgerufen wurden, keine Haftung übernehmen.

## BG

- T30** Eventуалната смяна на дефектни крушки трябва да се извърши в студено състояние на крушката с помощта на мека платнена кърпа, защото иначе е възможно да настъпи отслабване на светлината. Новата крушка трябва да има същите технически данни като наличната при закупуването!
- T31** Електрическа късна мрежа, контакт за включване, огледан шкаф, син, зелено-жълт, кафяв
- T32** Внимание! Включването в ел. мрежата трябва да допослежда в контакт за включване (контакта не се съдържа в опаковката на шкафа).
- T33** Включването на шкафа в ел. мрежата трябва непременно да се извърши от специалист, като непременно се спазва **VDE 0100 част 701!**
- T34** Огледан шкаф, електрическа късна мрежа
- T35** За включването на шкафа в ел. мрежата трябва непременно да повикате специалист!
- T36** Интернационална норма, европейска норма, Франция, Великобритания, Белия, Испания, Италия, Нидерландия
- T37** Внимание! При погрешен монтаж, шкафът/огледалото могат да паднат и да нанесат щети.
- T38** Внимавайте при окачването на шкафа, окачалките правилно да увиснат на предназначението за окачване плоски или кръгли кукички. След окачването на шкафа трябва бързо да се настройка, което се намира на елемента за окачване (окачалката), да се завие така, че шкафът да прилепне плътно до стената.
- T39** Моля не употребявайте за почистване на огледалото твърди или остри предмети, защото може да го надраскате.
- T40** Моля проявете разбиране, че при щети, възникнали поради неправилно окачване или при неправилна ел. инсталация на шкафа/огледалото, не поемаме отговорност.

## CZ

- T30** Eventuální výměna defektních svítek by měla být prováděna ve studeném stavu za pomoci měkkého hadříku, protože jinak může dojít ke snížení jasnosti.
- Nové vsazované svídko musí vykazovat stejné technické údaje, jako to, které bylo instalováno při koupi skřínky!
- T31** Domovní síť, přípojná krabice, zrcadlová skříňka, modrá, zeleno-žlutá, hnědá
- T32** Pozor! Připojení na síť musí být provedeno v přípojně krabici (není obsažena v rozsahu dodávky).
- T33** Elektrická přípojka skřínky musí být provedena odborníkem při respektování **VDE 0100 část 701!**
- T34** Zrcadlová skříňka, domovní síť
- T35** Elektrickou přípojku nechte provést odborníkem!
- T36** Mezinárodní norma, Euronorma, Francie, Velká Británie, Belgie, Španělsko, Itálie, Nizozemsko
- T37** Pozor! Při chybné montáži mohou vzniknout škody způsobené spadnutím skřínky/zrcadla.
- T38** Při zavěšení skřínky/zrcadla dbejte na to, aby závěsný prvek správně zapadl do závěsné desky, resp. do šroubovacího háku. Po zavěšení skřínky tuto pomoci stavečního šroubu na závěsném prvku přitáhnout ke zdi.
- T39** Na čištění zrcadla nepoužívejte žádné tvrdé a ostré předměty, protože tím může dojít k poškrábání zrcadla.
- T40** Žádáme Vás o pochopení, že neručíme za škody způsobené neodborným zavěšením nebo neodbornou elektrickou instalací.

## DK

- T30** Et evt. skift af defekte lysmidler bør gennemføres i kold tilstand med en blød stoffklud, da lyskraften ellers kan blive svagere.
- Det nyindsatte lysmiddel skal have de samme tekniske data som det, der var sat i ved købet!
- T31** Husnet, tilslutningsdåse, spejlskab, blå, grøn-gul, brun
- T32** Pas på! Nettilslutningen skal ske i en tilslutningsdåse (følger ikke med leveringen).
- T33** Skabets elektriske tilslutning skal gennemføres af en fagmand iht. **VDE 0100 del 701!**
- T34** spejlskab, husnet
- T35** få en fagmand til at gennemføre den elektriske tilslutning!
- T36** International standard, europanorm, Frankrig, Storbritannien, Belgien, Spanien, Italien, Nederlande
- T37** Pas på! Forkert montering kan føre til skader som følge af nedstyrning af skabet/spejlet.
- T38** Vær under opmærksomhed af skabet/spejlet opmærksom på, at skabsophængeren falder rigtigt i ophængspladen hhv. skrueløkken. Når skabet er hængt op, trækkes det vha. stillekruen på skabsophængeren langs med væggen.
- T39** Spejlene må ikke rengøres med hårde og skarpe genstande, der spejlene derved kan blive ridset.
- T40** Vi beder Dem have forståelse for, at vi fraskriver os ansvaret for skader, der skyldes forkert ophængning eller elektrisk installation

## EE

- T30** Defektned valgusalikaks tuleb vahetada välja jahutunud olekus, kasutades selleks pehmet lappi, sest muidu võib nõrgeneda lambi valgusjõud.
- Uus paigaldatav valgusalikaks peab olema samade tehniliste andmetega nagu see, mis oli lambi sees ostes!
- T31** Hoone elektrivõrk, ühenduskarp, peeglikapp, sinine, rohekasollane, pruun
- T32** Tähelepanu! Elektrivõrku ühendamine peab toimuma ühenduskarbis (ei ole tamedekomplektis).
- T33** Kapi elektrivõrku ühendamine peab teostama elektrik **VDE 0100 osa 701 kohaselt!**
- T34** Peeglikapp, hoone elektrivõrk
- T35** Laske kapp ühendada elektrivõrku elektrikul!
- T36** Rahvusvaheline norm, Euroopa norm, Prantsusmaa, Suurbritannia, Belgia, Hispaania, Itaalia, Madalmaad
- T37** Tähelepanu! Väärja paigaldamise korral võib kapi/peegli allakuumine põhjustada kahju tekke.
- T38** Pidage kapi/peegli ülesriputamisel silmas seda, et kinnitusavad fikseeruksid korralikult plaati või konksudele. Pärast kapi ülesriputamist reguleerida see seadekruvi abil seinal õigesti.
- T39** Peegli puhastamiseks ärge kasutage palun kõvu ja teravaid esemeid, sest see võib kriimustada peeglit.
- T40** Palume Teile mõistvat suhtumist, et me ei saa võtta endale vastutust kahjude eest, mis on põhjustatud asjatundmatust paigaldamisest või elektristallatsioonist.

## ES

- T30** Realizar el cambio eventual de medios luminicos defectuosos en estado frio con la ayuda de un paño suave, porque sino se puede debilitar la fuerza luminica.
- El nuevo medio luminico a aplicar debe tener los mismo datos técnicos que el que habia en el momento de la compra.
- T31** Red casera,Enchufe, armario de espejos, azul, verde-amarillo,marrón
- T32** ¡Atención! La conexión a red se debe realizar en un enchufe (no contenido en el conjunto suministrado)
- T33** La conexión eléctrica del armario la debe realizar un profesional respetando el VDE 0100 parte 701
- T34** Armario de espejos, red casera
- T35** Deje que un profesional realice la conexión eléctrica
- T36** Norma internacional, Norma europea,Franca, Granbretaña,Bélgica, España, Italia, Países Bajos
- T37** ¡Atención! En caso de montaje defectuoso se pueden ocasionar daños por la caída del armario/espejo.
- T38** Tenga cuidado al colgar el armario/espejo que el colgador del armario esté bien enclavado en la placa de colgar o el gancho roscado.Después de colgar el armario ajustar bien hacia la pared por medio del tornillo de ajuste en el gancho del armario
- T39** Para la limpieza de los espejos no use objetos duros y afilados porque se podrían rayar los espejos.

- T41** Sмяна на стъклото или крушката:
- T42** Вътрешният покривен пръстен да се повдигне внимателно с остър предмет от всички страни.
- T43** Всяко стуквало се предпазно покритие трябва да се смени.
- T44** При еграждането на покривния пръстен, като държи стъклото, внимавайте металната пластинка и дупката във фасунката да са една срещу друга.
- T45** ! Крушките могат да бъдат закупени в специализирани магазини, затова са изключени от гаранцията!
- T46** Ако има напички!
- T47** Внимание! Опасност от счуване!
- T48** Моля внимавайте при окачването на шкафа на стената специалистът, който извършва ел. инсталацията да не претисне или пречули кабела, по който тече тока.
- T49** Отнемете бledата, завъртете крушката и тогава я отнемете от закрепващото устройство.
- T50** Относно лампата
- T51** Щипка
- T52** От ел. ключалконтакта

- T41** Výměna rozptylového stínidla resp. svítidla:
- T42** Vnitřní kroužek krytí pomoci špičatého předmětu kolem dokola opatrně nadzdvihnout.
- T43** Každý prasklý ochranný kryt musí být nahrazen.
- T44** Při opětné montáži záchytného kroužku sčla dbát na to, aby prvek s otvorem ležel proti objemu.
- T45** !Svítidla obdržíte v odborném obchodě, tato jsou ze záruky vyloučena!
- T46** Je-li k dispozici!
- T47** Pozor! Nebezpečí prasknutí!
- T48** Zrcadlovou skříňku upevněte prosím na stěně tak, aby při provádění elektrické přípojky odborníkem nebyly kabely pro přívod elektrického proudu zmačknuty nebo ohnuty.
- T49** Clonu stáhnout, svídko pootočit a poté jej vyjmout z objímky.
- T50** ke svídku
- T51** svorka
- T52** od spínače/zásuvky

- T41** Skift af strøskive hhv. lysmiddel:
- T42** Løft den indvendige afdækningsring forsigtigt af hele vejen rundt med en spids genstand.
- T43** Hver sprunget beskyttelsesafdækning skal erstattes.
- T44** Sørg under genmonteringen af glasholderingen for, at snippen ligger over for hullet i fætningen.
- T45** !Lysmidler fås i faghandleren, de er ikke dækket af garantien!
- T46** Hvis til stede!
- T47** Pas på! Brudfare!
- T48** Fastgør spejlskabet på væggen, så kablet til strømledningen hverken klemmes eller knækkes under tilslutningsarbejdet af en fagmand.
- T49** Fjern blandestykket, drej lysmidlet og tag det så ud af holderen.
- T50** til lampen
- T51** klemme
- T52** fra kontakt/stikdåse

- T41** Hajutusketta või valgusalikaks vahetamine:
- T42** eemaldage terava esemega ettevaatlikult ümberingli liigutades sisemine katterõngas.
- T43** Purunenud kaitsekate tuleb alati asendada.
- T44** Klaasist rõnga tagasipanekul jälgige seda, et lapats asetseks pesa auguga vastakuti.
- T45** !Valgusalikad on kaupluses saadaval, garantii neid ei hõlma!
- T46** Kui olemas!
- T47** Tähelepanu! Purunemisoh!
- T48** Kinnitage palun peeglikapp seina külge selliselt, et selle elektriku poolt elektrivõrku ühendamisel totejuhet ei muljutaks ega murruks.
- T49** Eemaldage kate, keerake valgusalikait ja võtke siis pesast välja.
- T50** lambi poole
- T51** klemm
- T52** lülitist/pistikupesast

- T40** Confiamos en que se comprende que no podemos asumir ninguna reclamación, en el caso de daños por colgarlo de manera inadecuada o por instalación eléctrica inadecuada
- T41** Cambio de la luna de dispersión o del medio luminico
- T42** Levantar con cuidado el anillo interior que cubre por medio de un objeto puntiagudo.
- T43** Cada cubierta de protección rota se tendrá que reemplazar
- T44** Al montar de nuevo el anillo que sujeta el vidrio hay que vigilar que la pieza de unión esté situada con el agujero del casquillo en frente
- T45** Los medios luminicos se obtienen en el comercio especializado, y no entran en la garantía.
- T46** Si es que existe.
- T47** ¡Atención! ¡Peligro de rotura!
- T48** Sujete el armario de espejos a la pared de tal forma que cuando el profesional realice la conexión eléctrica los cables de conexión a red no resulten chafados ni doblados
- T49** Retirar el embellecedor, rosacar el medio luminico y retirar de la sujeción.
- T50** a la lámpara
- T51** Grapa
- T52** del interruptor/enchufe

## FI

- T307** Jos joudut vaihtamaan lampun, suorita se lampun ollessa kylmä ja käytä apuna pehmeää liinaa, koska lampun valaistusteho voi muuten heikentyä.
- Uuden lampun teknisten tietojen on vastattava alkuperäisen lampun tietoja.
- T317** verkkovirta, liitäntärasia, peiliikaappi, sinen, vihreä-keltainen, ruskea
- T327** Huom! Peiliikaappi liitetään liitäntärasiaan (ei kuulu toimitukseen).
- T337** Sähköliitäntä on suoritettava **VDE 0100 -standardin kohtaa 701** noudattaen ja sen saa tehdä ainoastaan sähköasentaja.
- T347** peiliikaappi, kotitaloussähkö
- T357** Anna sähköliitäntä sähköasentajan tehtäväksi!
- T367** Kansainvälinen standardi, eurooppalainen standardi, Ranska, Iso-Britannia, Belgia, Espanja, Italia, Alankomaat
- T377** Huom! Jos asennus suoritetaan väärin, putoava kaappi tai peili voivat aiheuttaa vaurioita.
- T387** Peiliikaappia asennettaessa on tarkistettava, että kaapin ripustimet lukkiutuvat kunnolla ripustuskoukkuihin tai ripustuslevyyn.
- Ripustuksen jälkeen kaappi vedetään säätöruuviv avulla kiinni seinään.
- T397** Älä käytä peilien puhdistukseen kovia tai teräviä esineitä, sillä ne saattavat vahingoittaa peilien pintaa.

## FR

- T307** Le remplacement éventuel d'ampoules défectueuses devra se faire lorsqu'elles sont froides à l'aide d'un chiffon doux car il pourrait se produire une réduction de la puissance d'éclairage.
- La nouvelle ampoule installée doit présenter les mêmes données techniques que celles lors de l'achat !
- T317** Secteur maison, prise électrique, armoire à miroir, bleu, vert-jaune, brun
- T327** Attention ! La prise de secteur doit se faire dans une prise électrique (non fournie).
- T337** Le raccordement électrique de l'armoire doit être effectué par un spécialiste en respectant la norme VDE 0100 partie 701!
- T347** Armoire à miroir, secteur maison
- T357** Faites réaliser le raccordement électrique par un spécialiste !
- T367** Norme internationale, norme européenne, France, Grande Bretagne, Belgique, Espagne, Italie, Pays Bas
- T377** Attention ! Si le montage est défectueux, il peut se produire des dommages causés par la chute de l'armoire/du miroir.
- T387** En suspendant l'armoire/le miroir, veillez à ce que les suspensions de l'armoire soient correctement engagées dans la plaque de suspension voire dans les crochets à vis. Après avoir suspendu l'armoire, la serrer contre le mur sur au moyen de la vis de réglage avec les crochets.
- T397** Pour le nettoyage du miroir, veuillez n'utiliser aucun objet dur et coupant qui pourrait rayer le miroir.

## GB

- T307** Replace defect lamps only in cold state using a soft cloth as otherwise the lamp's illuminating power could be diminished. Replaced lamps should have the same technical data as the lamps included in the original delivery.
- T317** house network, wall sockets, mirrored cupboard, blue, green & yellow, brown
- T327** IMPORTANT! Connection to the mains MUST be through a connector box (not included in delivery).
- T337** Have the cupboard's electric connection made by an electrician in compliance with **VDE 0100, part 701!**
- T347** mirrored cupboard, house network
- T357** Have the connection to the electrical supply made by an electrician!
- T367** international standard, European standard France, United Kingdom, Belgium, Spain, Italy, the Netherlands
- T377** CAUTION! Improper installation may cause damages by collapsing cupboard and/or mirror.
- T387** Make sure cupboard hanger properly engages with the mounting plate and the screw hook when hanging your cupboard and mounting your mirror, respectively. Once your cupboard is placed properly, use regulation screw at the cupboard hanger so as to justify your cupboard in a position even with the wall.
- T397** Do not use hard or sharp items for cleaning as this may cause scratches to your mirrors.

## GR

- T307** Η ενδεχόμενη αντικατάσταση ελαττωματικών λαμπτήρων πρέπει να γίνεται σε κρύα κατάσταση με τη βοήθεια ενός μαλακού υφασμάτινου πανιού, διότι εδαλλώως μπορεί να μειωθεί η φωτεινή ισχύς.
- Ο νέος λαμπτήρας πρέπει να έχει τα ίδια τεχνικά στοιχεία, όπως αυτό που υπήρχε κατά την αγορά!
- T317** Οικιακό δίκτυο, πρίζα σύνδεσης, ντουλάπι με καθρέφτη, μπλε, πράσινο-κίτρινο, καφέ
- T327** Προσοχή! Οι σύνδεση στο δίκτυο πρέπει να γίνεται με πρίζα σύνδεσης (δεν συμπεριλαμβάνεται στα παραδοτέα).
- T337** Η ηλεκτρική σύνδεση του ντουλαπιού πρέπει να εκτελείται από έναν ειδικό, λαμβάνοντας υπόψη την **VDE 0100 Μέρος 701!**
- T347** Ντουλάπι με καθρέφτη, οικιακό δίκτυο
- T357** Η ηλεκτρική σύνδεση να εκτελείται από έναν ειδικό!
- T367** Διεθνές πρότυπο, ευρωπαϊκό πρότυπο, Γαλλία, Βέλγιο, Ισπανία, Ιταλία, Ολλανδία.
- T377** Προσοχή! Σε περίπτωση εφαρμόζουσας συναρμολόγησης μπορούν να προκληθούν ζημιές από την πτώση του ντουλαπιού/του καθρέφτη.
- T387** Κατά την ανάρτηση του ντουλαπιού/του καθρέφτη προσέξτε, ώστε η ανάρτηση του ντουλαπιού να πνείνει σωστά στην πλάκα ανάρτησης ή στο βιδωτό γάντζο. Μετά την ανάρτηση του ντουλαπιού, τραβήξτε το μέσω της βίδας ρύθμισης στην ανάρτηση ντουλαπιού εφαρμσασά στον ταίχο.
- T397** Παρακαλώ μη χρησιμοποιείτε σκληρά και αιχμηρά αντικείμενα για τον καθαρισμό των καθρεπτών, διότι αυτό μπορούν να τους χαράξουν.

## HU

- T307** A hibás izzók esetleges cseréjét hideg állapotban, puha ruha segítségével kell végezni, mivel különben a fényerő gyengülése léphet fel.
- Az újonnan használandó izzóknak ugyanolyan műszaki adatokkal kell rendelkeznie, mint a vásárlásakor izzóknak!
- T317** Házi hálózat, csatlakozódoboz, tükrös szekrény, kék, zöld-sárga, barna
- T327** Figyelem! A hálózati csatlakoztatásnak csatlakozódobozban kell történnie (ezt a szállítási terjedeleme nem tartalmazza).
- T337** A szekrény villamos csatlakoztatását a **VDE0100 701. rész** alapján szakembernek kell végeznie!
- T347** Tükrös szekrény, házi hálózat
- T357** A villamos csatlakoztatást szakemberrel kell elvégeztesetni!
- T367** Nemzetközi szabvány, Európai Szabvány, Franciaország, Nagy-Britannia, Belgium, Spanyolország, Olaszország, Hollandia
- T377** Figyelem! Hibás szerelésnél károk keletkezhetnek a szekrény/tükör lezuhanása miatt.
- T387** A szekrénytükör felfüggesztésénél ügyeljen arra, hogy a szekrénykaszító megfelelően akadjon be a függesztőlemezbe ill. a csavaros kampóba. A szekrény felfüggesztése után azt a szekrénykaszítón lévő állítócsavarral a falal egy vonalba kell húzni.
- T397** A tükör tisztításához ne használjon kemény és éles tárgyakat, mivel az a tükört megkarcolhatja.
- T407** Kérjük, legyenek megértőek, hogy azokért a károkat, melyeket a szakszerűtlen felfüggesztés vagy villanyserelés okozott, nem vállalunk felelősséget.

- T407** Huomatamme erityisesti sitä, ettemme vastaa vaurioista jotka aiheutuvat virheellisestä ripustuksesta tai sähköasennuksesta.
- T417** Suojalasin tai lampun vaihtaminen:
- T427** Irota sisempi peiterengas varovasti terävästä esineellä.
- T437** Säilytymy suojalasi on ehdottomasti vaihdettava.
- T447** Kun kiinnität lasin kiinnitysrengas uudelleen, tarkista että reiläinen uloke tulee kantaa vastapäätä.
- T457** Huom! Lamppuja saa sähköliikkeistä ja ne eivät kuulu takuun piiriin!
- T467** Mikäli kuuluu malliin!
- T477** Varoitus! Särkymissaara!
- T487** Huolehdi kaappia seinään kiinnittäessäsi, että et liität tai taita sähköjohtoa, jonka asentaja liittää sähköverkkoon.
- T497** Vedä suojus irti, käännä lamppua ja irrota se kannastaan.
- T507** lamppuun
- T517** liitin
- T527** katkaisijasta/pistorasiasta

- T407** Nous comptons sur compréhension pour le fait que nous déclinons toute responsabilité pour les dommages causés par une suspension ou une installation électrique qui ne sont pas correctement effectuées.
- Remplacement du verre diffusant ou de l'ampoule :
- T417**
- T427** Soulever avec précaution la bague de recouvrement avec un objet pointu.
- T437** Il faut remplacer chaque protection ébréchée.
- T447** En remplaçant la bague de maintien du verre, veillez à ce que la patte soit en face du trou de la douille.
- T457** ! Les ampoules sont disponibles dans le commerce, elles sont exclues de la garantie !
- T467** Si existant !
- T477** Attention ! Risque de cassure !
- T487** Fixez l'armoire à miroir sur le mur de manière à ce que, lors du raccordement électrique par le spécialiste, le câble d'alimentation électrique ne soit ni écrasé ni plié.
- T497** Retirez les caches, tournez l'ampoule et retirez-la du support.
- T507** sur la lampe
- T517** borne
- T527** du contacteur/de la prise électrique

- T407** You may understand that we will not assume liability for damages caused by improper hanging and/or electric installation work.
- T417** replacement of diffuser pane and/or lamp
- T427** Slightly lever internal cover ring all round using a spiky tool.
- T437** Replace all broken safety covers.
- T447** When re-mounting the glass retaining ring, make sure the bracket hole is opposite the fixture.
- T457** !Lamps are available from specialist stores. Lamps are excluded from warranty!
- T467** if existing
- T477** CAUTION! Risk of breaking!
- T487** Fix your mirrored cupboard to the wall so as to avoid electrical supply cables becoming crushed or bent after installation by an electrician.
- T497** Take off shade, turn lamp to take it out of fixture.
- T507** to the lamp
- T517** terminal
- T527** from the switch / the wall socket

- T407** Παρακαλώ δείξτε κατανόηση για το ότι δεν αναλαμβάνουμε ευθύνη για ζημιές, που προκλήθηκαν από την εσφαλμένη ανάρτηση ή ηλεκτρική σύνδεση.
- T417** Αντικατάσταση του δίσκου διάχυσης ή του λαμπτήρα:
- T427** Σηκώστε τριγύρω προσεκτικά με ένα αιχμηρό αντικείμενο τον εσωτερικό δακτύλιο κάλυψης.
- T437** Κάθε προστατευτικό κάλυμμα που ράγιος πρέπει να αντικαταστήσει.
- T447** Κατά την επανατοποθέτηση του δακτυλίου στερέωσης γυαλιού, προσέξτε ώστε η γλώσσα με την οπή να είναι αντίπερα της υποδοχής.
- T457** !Λαμπτήρες διαθέτονται στο ειδικό εμπόριο και αποκλείονται από την εγγύηση!
- T467** Εάν υφίσταται!
- T477** Προσοχή! Κίνδυνος θραύσης!
- T487** Παρακαλώ στερεώστε το ντουλάπι με καθρέφτη κατά τέτοιο τρόπο στον ταίχο, ώστε κατά την ηλεκτρική σύνδεση από έναν ειδικό να μη συνθλιβεί ή σπείσει το καλώδιο για την προσαγωγή ρεύματος.
- T497** Τραβήξτε την καλύπτρα, στρέψτε τον λαμπτήρα και αφαιρέστε τον από την συγκράτηση.
- T507** προς τον λαμπτήρα
- T517** επαφή
- T527** από διακόπτη/πρίζα

- T417** A fonszor ill. az izzó cseréje:
- T427** A belső fedőgyűrűt egy hegyes tárggyal óvatosan, körben emelje le.
- T437** Minden szétgúrt védőfedelelet cserélni kell.
- T447** Az üveg tartógyűrűt ójbóli beszerelésénél ügyeljen arra, hogy a fül a foglalatlan lévő lyukkal szemben legyen.
- T457** !Izzók a szakkereskedelemben kaphatók, azok a szavatosság hatálya alól ki vannak zárva!
- T467** Ha van!
- T477** Figyelem! Törésveszély!
- T487** Kérjük, a tükrös szekrényt úgy rögzítse a falhoz, hogy a szakember által végzett elektromos csatlakozásánál a bemenő áramkábél ne csíródjon be és ne törjön meg.
- T497** Húzza le a takarólapot, forgassa az izzót, majd vegye ki a tartóból.
- T507** a lámpához
- T517** kapcsol
- T527** a kapcsolóról/dugaszolóaljzatról

## IT

- T30** L'eventuale sostituzione di lampade difettose deve avvenire, una volta che queste si siano raffreddate, aiutandosi con un panno morbido, poiché altrimenti potrebbe verificarsi un indebolimento della luminosità.
- La lampada da sostituire deve mostrare le stesse caratteristiche tecniche di quella in dotazione all'acquisto!
- T31** Rete elettr. domestica, presa, armadietto a specchio, blu, verde-giallo, marrone
- T32** Attenzione! Il collegamento alla rete elettrica deve avvenire con una presa (non in dotazione alla fornitura).
- T33** L'attacco elettrico dell'armadietto deve essere eseguito da personale qualificato in osservanza alla **VDE 0100 Parte 701!**
- T34** Armadietto a specchio, rete elettr. domestica
- T35** Far eseguire l'allacciamento elettrico da personale qualificato!
- T36** Norma internazionale, norma europea, Francia, Gran Bretagna, Belgio, Spagna, Italia, Paesi Bassi
- T37** Attenzione! In caso di montaggio errato, possono verificarsi danni dovuti alla caduta dell'armadietto/dello specchio.
- T38** Fare attenzione nell'attaccare l'armadietto/lo specchio che il dispositivo di sospensione s'inserisca correttamente a scatto nell'apposita piastra o nel gancio a vite. Dopo aver appeso l'armadietto, tirarlo a paro della parete stringendo la vite di regolazione sul dispositivo di sospensione.
- T39** Per la pulizia degli specchi non utilizzare oggetti duri e taglienti, poiché gli specchi potrebbero venir graffiati.

## LT

- T30** Keičiant perdegusią elektros lemputę, reikia, kad ji būtų atvėsusi bei naudoti minkštą skudurėlį, nes kitaip gali sumažėti apšvietimo stiprumas.
- Naujai keičiama elektros lemputė turi turėti tuos pačius techninius duomenis, kaip toji, kuri ten buvo įsigyjanti spintelė!
- T31** Namų elektros tinklas, rozetė, veidrodinė spintelė, mėlyna, žalia-geltona, ruda
- T32** Dėmesio! Elektros tinklas turi būti pajungiamas į rozetę (pakotėje jos nėra).
- T33** Spintelės apšvietimo pajungimas turi būti atliekamas elektros specialisto, laikantis visų pajungimui keliamų reikalavimų!
- T34** Veidrodinė spintelė, namo elektros tinklas
- T35** Elektrosrovės pajungimas turi būti atliekamas šios srities specialisto!
- T36** Tarptautinė norma, Europinė norma, Prancūzija, Didžioji Britanija, Belgija, Ispanija, Italija, Olandija
- T37** Dėmesio! Dėl neteisingo montavimo nukritus spintelė / veidrodžiui galite apturėti žalą.
- T38** Pakabinami spintelė/veidrodį atkreipkite dėmesį į tai, kad spintelės pakabinimo kilpelės teisingai įsikabintų į pakabinimo plokštę arba į pakabinimo kabilus. Pakabinę spintelę, reguliavimu varžtais, esančiais ant pakabinimo kabilų, pritraukite ją lygiai prie sienos.
- T39** Veidrodžių valymui nenaudokite jokių kietų bei aštrių daiktų, nes taip gali būti subraižyti veidrodžiai.
- T40** Tikimės iš Jūsų suprasti, kad mes už žalą, sukeltą neteisingai montuojanti arba neteisingai pajungiant prie elektros tinklo atsakomybės sau neprisiimame.

## LV

- T30** Ja nepieciešams nomainīt defekto apgaismojuma elementu, veiciot to tikai pēc atdzišanas, izmantojot mīkstu drāniņu, pretējā gadījumā var samazināties starošanas spēja. Jaunajam elementam jābūt ar tiem pašiem tehniskajiem parametriem kā līdzniecībā nokomplektētajam.
- T31** Mājā pieejamais sprieguma tīkls, pieslēguma kontaktligzda, spoguļskapis, zāļi, zāļi dzelzēns, brūns
- T32** Uzmanību! Pieslēgumu tīklam jāveic tikai izmantotajai pieslēguma kontaktligzdai (nav komplektācijas apjoma).
- T33** Skapja elektrības vadu pieslēgšanu drīkst veikt tikai speciālists, ievērojot standartu **VDE 0100 701. daļas** prasības.
- T34** Spoguļskapis, mājā pieejamais sprieguma tīkls
- T35** Elektroinstalācijas darbu veiksano uzziect tikai speciālistam!
- T36** Starptautiskais standarts, Eiropas standarts, Francija, Lielbritānija, Beļģija, Spānija, Itālija, Nīderlandē
- T37** Uzmanību! Ja montāža tiks izpildīta nepareizi, skapis/spoguļis var nokrist un tā rezultātā rasties bojājumi un zaudējumi.
- T38** Iekārot skapi/spoguļi pārīcinieties, lai skapja pakāršanas elementi būtu pareizi notīstīti stiprināšanas plātnē evl. skrūvējamajā āķī.
- Pēc skapja uzkaršanas ar iestaffšanas skrūvi pakāršanas elementu daļā to izvietojiet tā, lai būtu pievilks pie sienas.
- T39** Lūdzu neizmantojiet spoguļa tīrīšanas cietus un asus priekšmetus, jo tāda veidā spoguļis var tikt saskrāpēts.
- T40** Lūdzu saproftēt mūs pareizi, ka par bojājumiem, kas rodas nepareizas stiprināšanas vai elektroinstalācijas rezultātā, mēs garantiju neuzņemamies.

## NL

- T30** De eventuele vervanging van defecte lampen moet in koude staat met behulp van een zachte stofdoek gebeuren, omdat anders het lichtgevend vermogen zou kunnen afnemen.
- De nieuw te plaatsen lamp moet dezelfde technische gegevens hebben als de lamp bij aankoop!
- T31** Huis-netwerk, aansluitdoos, spiegelkast, blauw, groen-geel, bruin
- T32** Pas op! De netaansluiting moet in een aansluitdoos (niet meegeleverd!) gebeuren.
- T33** Bij de elektrische aansluiting van de kast moet rekening gehouden worden met de norm **VDE 0100 Deel 701**.
- Dit moet door een vakman gebeuren!
- T34** Spiegelkast, huis-netwerk.
- T35** Laat de elektrische aansluiting door een vakman uitvoeren.
- T36** Internationale normen, Europese norm, Frankrijk, Groot-Brittannië, België, Spanje, Italië, Nederland
- T37** Pas op! Bij een foutieve montage kan schade door een vallende kast/spiegel ontstaan.
- T38** Controleer bij het ophangen van de kast/spiegel dat de ophanging van de kast correct in de ophangplaat resp. de schroefhaak insluit. Na het ophangen van de kast, deze door middel van de stelschroef aan de ophanging vlak tegen de wand trekken.
- T39** Gebruik geen harde of scherpe voorwerpen om de spiegel te reinigen, hierdoor kunnen er krassen ontstaan.

## PL

- T30** Ewentualna wymiana niesprawnych źródków Źwięcających winna się odbywać w stanie zimnym za pomocą miękkiej szmatki, ponieważ w przeciwnym razie moze nastąpić osłabienie zdolności oświelelniowej.
- Nowy źródek Źwięcający musi posiadać takie same parametry techniczne jak źródek Źwięcający przy zakupie!
- T31** Sieć domowa, gniazdo przyłączeniowe, szafka z lustrem, niebieski, zielono-żółty, brązowy
- T32** Uwaga! Podłączenie do sieci elektrycznej musi się odbyć w gnieździe przyłączeniowym (trak w zestawie).
- T33** Podłączenie szafki do sieci elektrycznej winno zostać przeprowadzone zgodnie z **VDE 0100 część 701** przez fachowca!
- T34** Szafka z lustrem, sieć domowa
- T35** Podłączenie do sieci elektrycznej należy zlecić fachowcowi!
- T36** Norma międzynarodowa, norma europejska, Francja, Wielka Brytania, Belgia, Hiszpania, Włochy, Holandia
- T37** Uwaga! W przypadku wadliwego montażu mogą wystąpić szkody spowodowane spadnięciem szafki / lustra.
- T38** Przy zawieszaniu szafki / lustra należy zwrócić uwagę na to, by uchwyt do zawieszenia szafki zaskoczył prawidłowo w płytce lub haku śrubowym. Po zawieszeniu szafki należy ją ściśle dociągnąć do ściany za pomocą śruby regulacyjnej przy uchwycie do zawieszenia szafki.
- T39** Do czyszczenia lustra nie stosować twardych i ostrych przedmiotów, ponieważ mogą one doprowadzić do zadrapania lustra.
- T40** Prosimy o zrozumienie, że nie ponosimy odpowiedzialności za szkody powstałe wskutek nieprawidłowego zawieszenia lub podłączenia do instalacji elektrycznej.

- T40** Si prega di comprendere che non rispondiamo di danni causati da un attacco o da un'installazione elettrica non effettuati a regola d'arte.
- T41** Sostituzione del cristallo o della lampada:
- T42** Con un oggetto acuminato far leva e sollevare con cautela tutt'intorno l'anello di copertura interno.
- T43** Ogni copertura protettiva rotta deve essere sostituita.
- T44** Nel rimontare l'anello di tenuta del vetro, fare attenzione che la linguetta si trovi contrapposta al foro del portalampada.
- T45** Le lampade sono disponibili presso i rivenditori specializzati. Non sono comprese nella copertura di garanzia!
- T46** Se presente!
- T47** Attenzione! Pericolo di rottura!
- T48** Si prega di fissare alla parete l'armadietto a specchio, in modo tale che al collegamento elettrico da parte di un elettricista specializzato il cavo della corrente non venga schiacciato o piegato.
- T49** Togliere la fascia di copertura, ruotare la lampada e poi estrarla dall'attacco.
- T50** verso la lampada
- T51** Morsetto
- T52** dall'interruttore/dalla presa

- T41** Šviesos šrauto skieistuvo arba elektros lemputės keitimas:
- T42** Vidinį dengiamąjį žiedą smaliu daiktu atsargiai aplinkui sukeikite.
- T43** Pakaiskite kiekvieną įtrūkusį apsauginį dangtelį.
- T44** Vėl įmontuodami stiklo laikymo žiedus, atkreipkite dėmesį į tai, kad liežuvelis gultų tiesiai virš rėmelio skylės.
- T45** I elektros lempučių galima įsigyti elektros prekių parduotuvės, joms mūsų garantija netaikoma!
- T46** Jeigu yra pakuotėje!
- T47** Dėmesio! Dūžta!
- T48** Spintelę pritrinkite prie sienos taip, kad specialistui jungiant elektros tinklą elektrosrovės laidai nebūtų prispausti arba sulenkti.
- T49** Nuimkite gaubtą, išukite elektros lemputę bei išimkite ją iš laikiklio.
- T50** į lempą
- T51** jungtis
- T52** nuo jungiklio/rozetės

- T41** Gaismas izkļiedšanas stikla vai apgaismojuma elementa nomaiņa:
- T42** Uzmaniģi noņemiet ar priekšmetu, kam ir ass gals, iekšējo noseģredzenu.
- T43** Nomainiet visu iepļaisģiģušos aizsargeļmentus pret jauniem.
- T44** Iebģvģjot stikla turģšanas greģzenu pāģricinģties par to, lai izvirģzģjums bģtu pret patronas atveri.
- T45** I apgaismojuma elementu ir pieģejami līdzniecģbā, tģdģģj uz tiem garantģja netiek sniegta!
- T46** Ja ir!
- T47** Uzmanģbu! Sapģfģšanas vai sapļaisģģšanas bģstāmģba!
- T48** Lģdzu nostiprinģt spoguļskapi pie sienas tģ, lai speciģlists, veģcot elektroinstalģciju, nesapsģestu vai nesalieģtu strģvas vadus.
- T49** Noģemģt pretapģģbinģģšanas pāģseģu un izņemģt apgaismojuma elementu no stiprinģjuma.
- T50** pie lampas
- T51** spāģle
- T52** no slģdzģa/kontaktģģzģdas

- T40** Gelieve er begrip voor te hebben dat wij voor schade, die door onvakkundige ophanging of elektrische installatie ontstaan is, geen aansprakelijkheid aanvaarden.
- T41** Verwijder de diffuser van het armatuur
- T42** De binneste afdekking met een puntig voorwerp voorzichtig rondom opheffen.
- T43** Alle gebarsten beschermingskappen kunnen worden vervangen.
- T44** Tijdens de nieuwe montage van de glashouder verzekeren dat de lip met het gat tegenover de lampenhouder ligt.
- T45** !Lampen zijn in de vakhandel verkrijgbaar, zij zijn niet inbegrepen in de garantie!
- T46** Indien beschikbaar!
- T47** Let op! Breekgevaar!
- T48** Bevestig de spiegelkast zodanig aan de wand dat bij de elektrische aansluiting door een vakman de kabel voor de stroomtoevoerleiding niet geklemd of gebogen wordt.
- T49** De kap eraf halen, de lamp draaien en daaruit de houder nemen.
- T50** naar de lamp
- T51** Klem
- T52** van schakelaar/contactdoos

- T41** Wymiana osłony rozpraszającej lub Źródka Źwięcającego:
- T42** Podnieść ostroźnie ze wszystkich stron za pomocą ostrego przedmiotu wewnętrzy pierścienia osłaniającego.
- T43** Kaźdą uszkodzoną osłonę zabezpieczającą należy wymienić.
- T44** Przy ponownym montażu pierścienia przytrzymującego szkło zwrócić uwagę na to, by jģszyczek znajdował się naprzeciwko otworu oprawy.
- T45** !Źródki Źwięcające sģ dostępane w sklepach specjalistycznych, nie sģ objęte gwarancją!
- T46** Jeģli dostępane!
- T47** Uwaga! Niebezpieczarstwo pęknģcia!
- T48** Zamocuj szafkę z lustrem na ścianie tak, by podczas jej podģczģnania do sieci elektrycznej przez fachowca kabel doprowadzģjący prąd nie został zgnģciony lub złamany.
- T49** Ściģgnij blendę, obróć Źródek Źwięcający, a następnģe wyցiągnij go z mocowania.
- T50** do lampy
- T51** zacisk
- T52** od włģcznika / gniazda

## PT

- T39** A eventual substituição de lâmpadas defeituosas deve ser levada a cabo quando estão frias com a ajuda de um pano macio, caso contrário, pode ocorrer uma redução da luminosidade.
- A lâmpada nova a colocar tem de apresentar os mesmos dados técnicos, tal como os que estão indicados no momento da compra!
- T37** Rede doméstica, tomada de ligação, armário com espelho, azul, verde-amarelado, castanho
- T32** Atenção! A ligação à rede tem de ser efectuada através de uma tomada de ligação (não incluída no fornecimento).
- T33** A ligação eléctrica do armário é efectuada por um técnico de acordo com a **VDE 0100 Parte 701!**
- T34** Armário com espelho, rede doméstica
- T35** Mandar um técnico efectuar a ligação eléctrica!
- T36** Norma internacional, norma europeia, França, Grã-Bretanha, Bélgica, Espanha, Itália, Países Baixos
- T37** Atenção! Em caso de montagem incorrecta, podem ocorrer danos devido à queda do armário/espelho.
- T38** Ao pendurar o armário/espelho, certifique-se de que o gancho está correctamente engatado na placa de suspensão ou no camarão. Após pendurar o armário, nivelá-lo ao gancho do armário com o parafuso de ajuste.
- T39** Para a limpeza do espelho, não utilize objectos duros e afiados, pois pode riscar o espelho.
- T40** Agradecemos a sua compreensão para o facto de não nos responsabilizarmos por danos que possam ser causados pela fixação ou pela instalação eléctrica indevida.

## RO

- T39** Eventuala înlocuire a lămpilor defecte trebuie efectuată în stare rece cu ajutorul unei lavete din stofă, din material moale, deoarece în caz contrar se poate atenua puterea de iluminat.
- Lampa nouă ce trebuie introdusă trebuie să aibă date tehnice identice cu cele ale lămpii existente la cumpărare!
- T37** Rețeaua electrică interioară, priză de conexiune, dulapuri cu oglindă, albastru, verde-gălbui, maro
- T32** Atenție! Conexiunea la rețea trebuie realizată într-o priză de conexiune (neinclusă în pachetul de livrare).
- T33** Conexiunea electrică a dulapurii trebuie realizată de către un specialist, cu respectarea **VDE 0100 Partea 701!**
- T34** Dulapul cu oglindă, rețeaua electrică interioară
- T35** Conexiunea electrică va fi realizată numai de către un specialist!
- T36** Normă internațională, Normă europeană, Franța, Marea Britanie, Belgia, Spania, Italia, Olanda
- T37** Atenție! În cazul montajului greșit pot rezulta daune cauzate de căderea dulapurii/oglinzii.
- T38** La suspendarea dulapurii/oglinzii, aveți grijă ca agățatorul dulapurii să intre corect în placa de suspendare, respectiv în cârșigul cu filet. După suspendarea dulapurii, aliniați-l la perete cu ajutorul șurubului de reglaj de pe agățatorul dulapurii.
- T39** Pentru curățarea oglinzilor, vă rugăm să nu utilizați obiecte dure sau ascuțite, deoarece acestea pot zgâria oglinzile.
- T40** Vă rugăm să aveți înțelegere pentru faptul că nu ne asumăm răspunderea pentru daune cauzate de suspendarea sau instalarea electrică necorespunzătoare.

## SE

- T39** Om ljuskällor behöver bytas ut måste man vänta tills de har svalnat och sedan använda en tygduk eftersom det annars finns risk för att belysningseffekten försämrars.
- Den nya ljuskällan måste ha samma tekniska data som ljuskällan som var monterad när du köpte skåpet!
- T37** Elnät i byggnaden, kopplingsdosor, spegelskåp, blå, grön-gul, brun
- T32** Obs! Elnätet måste anslutas i en kopplingsdosor (medföljer ej).
- T33** Skåpet måste anslutas till elnätet av en behörig elinstallatör enligt föreskrifterna i **VDE 0100 del 701!**
- T34** Spegelskåp, elnät i byggnaden
- T35** Låt en behörig elinstallatör utföra anslutningen till elnätet!
- T36** Internationell standard, Europastandard, Frankrike, Storbritannien, Belgien, Spanien, Italien, Nederländerna
- T37** Varning! Vid felaktig montering kan skador uppstå om skåpets/pegeln faller ned.
- T38** När du hänger upp skåpet/spegeln måste du se till att skåpphängningen hakar in rätt i upphängningsplattan resp. skruvkroken. Efter att du hängt upp skåpet måste du dra åt ställskruven på skåpphängningen så att skåpet dänerter ligger plant mot väggen.
- T39** Rengör inte spegeln med hårda eller vassa föremål som kan repa spegeln.

## SI

- T39** Morebitna zamenjava okvarjenih žarnic mora potekati v hladnem stanju s pomočjo mehke krpe iz blaga, ker bi sicer lahko prišlo do oslabitve svetlosti.
- Žarnice, ki jih je potrebno na novo vstaviti, morajo imeti enake tehnične podatke, kot liste ob nakupu!
- T37** Hišno omrežje, priključna doza, omara z ogledalom, modra, zeleno-rumena, rjava
- T32** Pozor! Priključitev na omrežje mora potekati v priključni dozi (ni vsebovano v obsegu dobave).
- T33** Električno priključitev omare mora izvesti strokovnjak ob upoštevanju **VDE 0100 Del 701!**
- T34** Omara z ogledalom, hišno omrežje
- T35** Električno priključitev naj izvede strokovnjak!
- T36** Mednarodni standard, Evropski standard, Francija, Velika Britanija, Belgija, Španija, Italija, Nizozemska
- T37** Pozor! Pri pomanjkljivi montaži lahko nastanejo škode zaradi padca omare/ogledala.
- T38** Pri obešanju omare/ogledala pazite na to, da je obešalnik za omaro pravilno zaskočen v obešalno ploščo oz. vijčno kljuko. Po obešanju omare, le-to povlecite s pomočjo naravnalnega vijaka na obešalniku omare poravnano na steno.
- T39** Za čiščenje ogledala ne uporabljajte trdih in ostrih predmetov, ker se s tem ogledala lahko razpraskajo.
- T40** Prosimo za razumevanje, da za škode, ki so bile povzročene zaradi nestrokovnega obešanja ali električne instalacije, ne prevzemamo nobenejamstva.

## SK

- T39** Eventualná výmena defektných svietidiel by mala byť prevádzaná po ich ochladení a za pomoci mäkkej handry, pretože inak môže dôjsť k zníženiu jasnosti.
- Novo vymieňané svietidlá musia vykazovať tie isté technické hodnoty, ako svietidlá nainštalované pri kúpe skrinky!
- T37** Domáca sieť, zrkadlová skrinka, modrá, zeleno-žltá, hnedá
- T32** Pozor! Pripojenie na sieť musí byť prevedené do zásuvky (nie je obsiahnutá v dodávke).
- T33** Elektrické pripojenie skrinky musí byť prevedené odborníkom za zohľadnenia **VDE 0100 časť 701!**
- T34** Zrkadlová skrinka, domáca sieť
- T35** Elektrické pripojenie nechajte previesť odborníkom!
- T36** Medzinárodná norma, Euronorma, Francúzsko, Veľká Británia, Belgicko, Španielsko, Taliansko, Holandsko
- T37** Pozor! Pri nesprávnej montáži môžu vzniknúť škody spôsobené pri páde skrinky/zrkadla.
- T38** Pri zavesovaní skrinky/zrkadla dbajte na to, aby závesný prvok správne zapadol do závesnej dosky, resp. na skrutkový hák. Po zavesení skrinku upevníte pomocou regulačnej skrutky na závesnom prvku tak, aby priliehala na stenu.
- T39** Na čistenie zrkadla nepoužívajte žiadne tvrdé a ostré predmety, pretože tak môže dôjsť k poškriabaniu zrkadla.
- T40** Žiadame Vás o porozumenie, ak neručíme za škody spôsobené neobornou montážou na stenu alebo neobornou elektrickou inštaláciou.

- T41** Substituição do difusor ou da lâmpada:
- T42** Levante cuidadosamente o anel interior de cobertura à volta com um objecto pontiagudo.
- T43** Substitua todas as tampas de protecção estaladas.
- T44** Ao voltar a montar o anel de fixação do espelho, certifique-se de que a lingueta fica oposta ao furo do suporte da lâmpada.
- T45** As lâmpadas estão à venda no comércio da especialidade, excluindo-se assim do período da garantia!
- T46** Se existente!
- T47** Atenção! Perigo de ruptura!
- T48** Fixe o armário com espelho à parede de modo a que, durante a ligação eléctrica levada a cabo pelo técnico, o cabo de alimentação de corrente não seja esmagado nem dobrado.
- T49** Retire o friso decorativo, rode a lâmpada e, a seguir, remova-a do casquilho.
- T50** para a lâmpada
- T51** Terminal
- T52** do interruptor/da tomada

- T41** Înlocuirea discului de difuzie, respectiv a lămpii:
- T42** Ridicați cu grijă de jur împrejur inelul interior de acoperire, cu ajutorul unui obiect ascuțit.
- T43** Orice capac de protecție crăpat trebuie înlocuit.
- T44** La remontarea inelului de susținere a sticlei, aveți grijă ca edisă să se suprapună cu gaura monturii.
- T45** Îlămpile se pot obține în comerțul de specialitate, fiind excluse de la garanție!
- T46** Dacă există!
- T47** Atenție! Pericol de spargere!
- T48** Vă rugăm să fixați dulapul cu oglindă de perete în așa fel încât la conectarea electrică de către specialist, cablul pentru alimentarea cu curent să nu fie strivit sau îndoit.
- T49** Scoateți placa-mască, răsucliiți lampa și scoateți-o apoi din suport.
- T50** la lampă
- T51** bornă
- T52** de la întrerupător/priză

- T49** Tack för din förståelse för att vi inte kan överta något ansvar för skador som har uppstått av ej föreskriven upphängning eller elektrisk installation.
- T41** Byta ut reflektor eller ljuskälla:
- T42** Bänd försiktigt loss den inre täckningen med ett spetsigt föremål längs med kanten.
- T43** Om skyddsglasat har spruckit måste det bytas ut.
- T44** När du monterar tillbaka fästingen till glasskivan måste du se till att tungan med hälet ligger emot fästningen
- T45** Ljuskällor kan köpas i en specialbutik. Dessa täcks inte av garantin!
- T46** Om förhånden!
- T47** Obs! Risk för sprickor!
- T48** Montera spegelskåpet på väggen så att nätedringen inte kläms eller viks när en behörig elinstallatör ska ansluta skåpet till elnätet.
- T49** Dra av täckplattan, vrid runt ljuskällan och ta sedan ut den ur hållaren.
- T50** till lampan
- T51** Anslutningsdön
- T52** från brytare/stickuttag

- T41** Menjava razpršilnega stekla oz. žarnic:
- T42** Notranji krovni obroček previdno naokoli privzdignite s koničastim predmetom.
- T43** Vsak razpokan zaščitni pokrov je potrebno zamenjati.
- T44** Pri ponovnem vstavljanju držalnega obročka stekla pazite na to, da leži vezica na nasprotni strani luknje okova.
- T45** Izžarnice so dobavljive v strokovni trgovini, iz garancije so izključene!
- T46** Če obstaja!
- T47** Pozor! Nevarnost zloma!
- T48** Pritrđite omaro z ogledalom na steno tako, da se pri električni priključitvi s strani strokovnjaka kabel za dovajanje električnega toka ne stisne ali prepogne.
- T49** Snemite zaslonko, obrnite žarnico in nato vzemite iz držala.
- T50** K luči
- T51** Objemka
- T52** Od stikala/zásuvnice

- T41** Výmena rozptyľového tienidla resp. svietidla:
- T42** Vnútrotný krúžok krytu opatrne kol dokola nadvihnúť pomocou hrotitého predmetu.
- T43** Každý prasknutý ochranný kryt sa musí vymeniť.
- T44** Pri opätovnej montáži záchytného krúžku skla dbať na to, aby časť, kde je otvor, ležala oproti objímke.
- T45** !Svietidlá obdržite v odbornej predajni, lietu so zo záruky vylúčené!
- T46** Pokiaľ je k dispozícii!
- T47** Pozor! Nebezpečenstvo prasknutia!
- T48** Zrkadlovú skrinku upevníte prosím na stenu tak, aby sa pri prevádzaní elektrického pripojenia odborníkom káble prevod elektrického prúdu nestlačili alebo neohli.
- T49** Zložte clonu, svietidlo otáčate a potom ho vybrať z objímky.
- T50** ku svietidlu
- T51** svorka
- T52** od spínača/zásuvky

(CN)

- T30** 有时需要更换坏掉的光源必须在光源冷却后，并用软布进行操作，否则可能会降低之后的发光强度。  
**新更换上的光源必须与原来的光源参数一致。**
- T31** 家用电网，接线盒，镜柜，蓝色，绿黄色，棕色
- T32** 注意！电源接线必须用接线盒（不随货附送）。
- T33** 柜子电源接线时必须由专业人士参照 **VDE 0100 Teil 701** 标准进行操作。
- T34** 镜柜，家庭电网
- T35** 电线连接请由专业电工来操作！
- T36** 国际标准，欧洲标准，法国，英国，比利时，西班牙，意大利，荷兰
- T37** 注意！安装错误可能引起柜子/镜子的掉落，从而导致其他损伤。
- T38** 在悬挂柜子/镜子时请注意，柜子上的侧柜吊钩要正确地插入挂片或螺丝挂钩中。  
挂好之后，通过对吊钩上调位螺丝的调节将柜子挂平整。
- T39** 为防止镜面刮花，清洁镜子时请不要使用硬的、锋利的工具。
- T40** 一些损伤是由于家具悬挂或电器安装未按规定操作所引起的，对此我们不予负责，敬请谅解。

- T41** 更换散光玻璃片或光源：  
**T42** 内部盖环用尖的工具小心地从四周挑起取下。  
**T43** 每个可拆卸的保护盖都是可更换的。  
**T44** 在重新装入玻璃支撑环时请注意，盖板要与灯头上的孔相反放置。  
**T45** ！光源可以在专营店买到，且不属于本产品的质保范围。  
**T46** 如果存在！  
**T47** 当心！破碎危险！  
**T48** 在往墙上固定镜柜时请注意，由专业电工接的电源线不要被压到或折起。  
**T49** 取下遮光罩，旋转光源，将其从支架中取出。  
**T50** 对于灯  
**T51** 接线柱  
**T52** 开关/插座

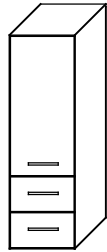

3\_\_-013556

9\_\_-013556

**T1** Bitte unbedingt ausfüllen!

Name -----

Strasse -----

PLZ ----- Ort -----

TeL. -----

**T2** Sehr geehrte Kunden, wir freuen uns, dass Sie sich für ein Produkt aus dem Hause Pelipal entschieden haben. Sollte es trotz aller Bemühungen unsererseits, Ihnen ein qualitativ hochwertiges Möbelstück zu liefern, zu Fehlteilen kommen, schicken Sie bitte dieses ausgefüllte Blatt an

Fax.: **+49 3443/434350**

E-Mail: **ersatzteile@pelipal.de**

Bitte beachten Sie, dass Bauteile über 800mm Länge und 350mm Breite direkt bei Ihrem Möbelhändler zu beanstanden sind. Zur Reklamationsbearbeitung ist es unbedingt erforderlich **die Artikelnummer des Schrankes**, welche auf dem Etikett ersichtlich ist und den Markt, wo das Möbel erworben wurde anzugeben. Außerdem tragen Sie unten bitte die benötigte Stückzahl ein. Viel Spaß mit Ihrem neuen Badmöbel!

Ihr Pelipal Team

-----

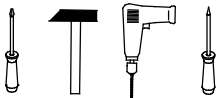





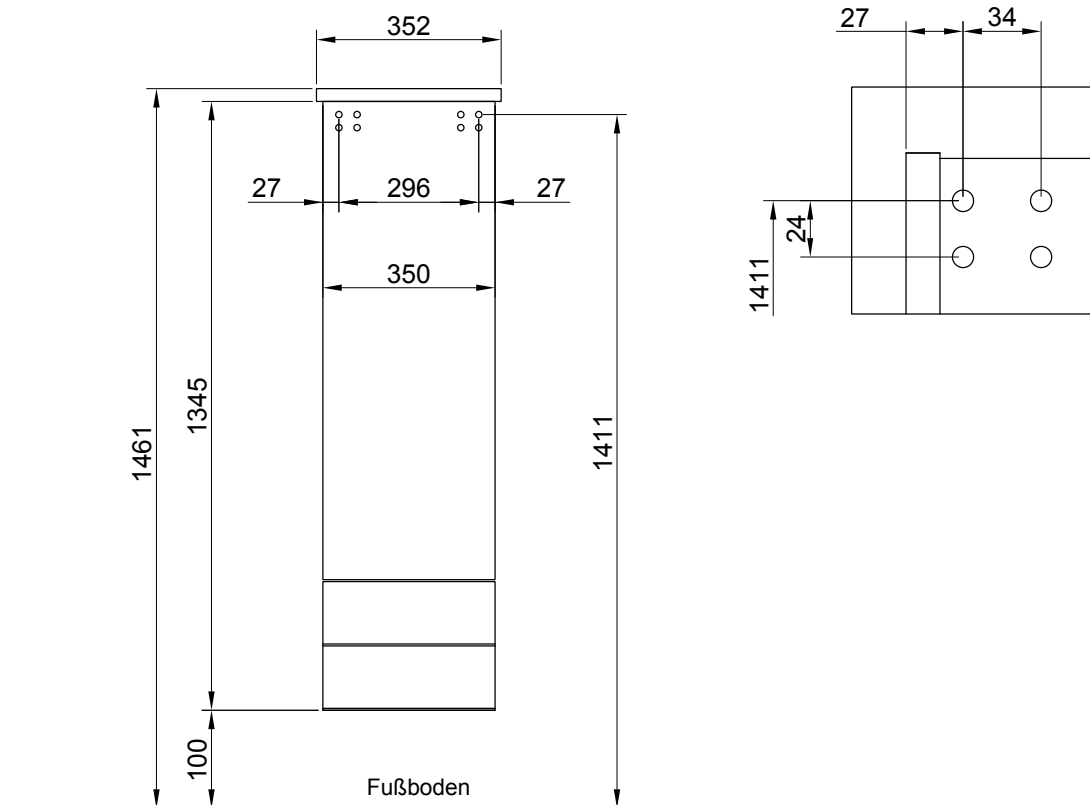





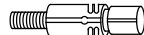

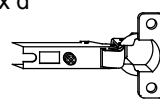
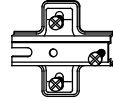

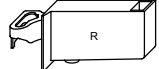

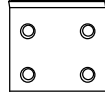

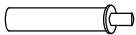

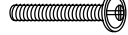
**T3** Für den Zusammenbau sind 2 Personen erforderlich.

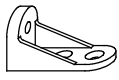
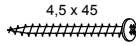
**T4** Montage-Richtzeit 3 Stunden

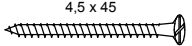
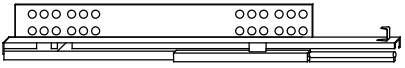
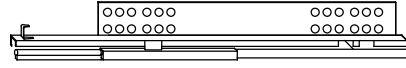

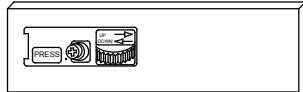
Die Maßangabe der Höhe ist nicht bindend!

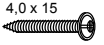
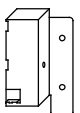
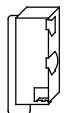

12 x a  EXZENTER-000015	Stück	12 x b  DUEB-SMD-000005	Stück	12 x c  TRAE-001-000020	Stück	5 x d  TBD-35-115X00	Stück	5 x e  ZPL-003X004	Stück
16 x f  SCH-KA-063X011	Stück	14 x g  SCH-SPA-035X015	Stück	1 x h  AUF-001-000080	Stück	1 x j  AUF-001-000090	Stück	2 x k  AUF-001-000030	Stück
12 x l  NAGEL-025X001	Stück	2 x m  TUER-DAEM-000010	Stück	2 x n  TUER-ADA-000010	Stück	4 x o  Griff	Stück	8 x p  SCH-SPA-045X045	Stück
4 x q  ADK-AL1-005X008	Stück	2 x r  RWD-KEI-000060	Stück	1 x s  VBD-000020	Stück	1 x t  SCH-RDK-045X045	Stück	1 x u  SCH-RDK-040X015	Stück
8 x v  SCH-SPA-045X045	Stück		Stück		Stück		Stück		Stück
2 x IT01  KA-260-LI			Stück	2 x IT02  KA-260-RE			Stück		Stück
2 x IT03  ZAR-260-LI			Stück	2 x IT04  ZAR-260-RE			Stück	4 x IT05  ADK-ZAR-ALU	Stück
24 x IT06  SCH-RDK-040X015	Stück	2 x IT07  VBD-ZAR-LI-70	Stück	2 x IT08  VBD-ZAR-RE-70	Stück	4 x IT09  VBD-ZAR-FRO	Stück		Stück

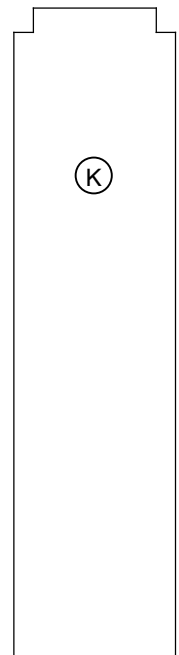
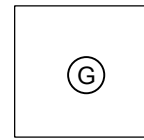
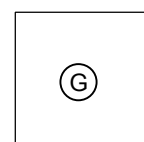
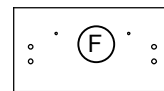
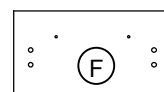
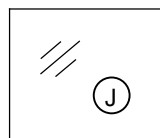
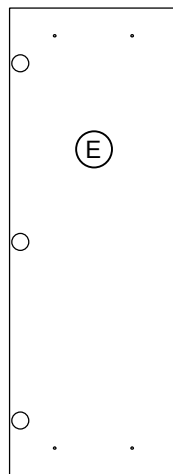
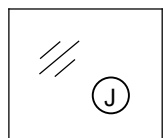
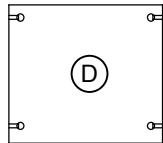
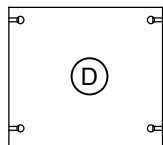
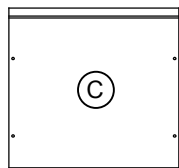
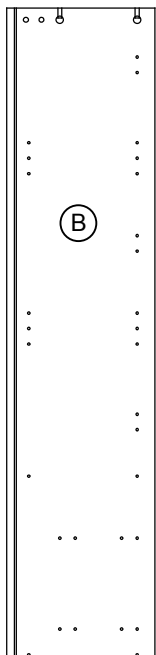
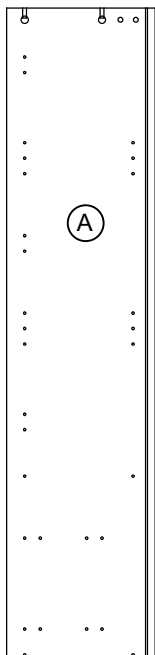

1.

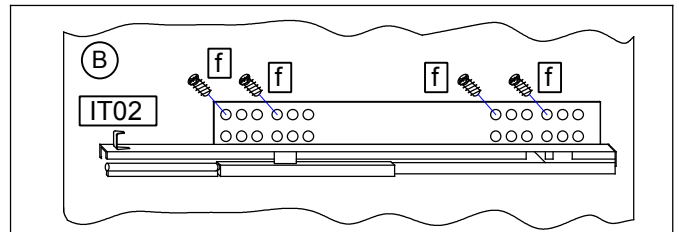
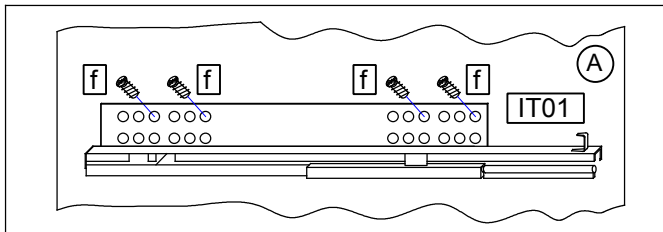
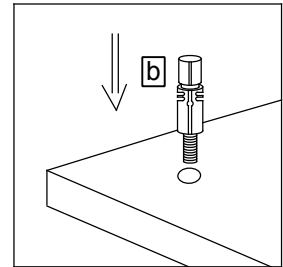
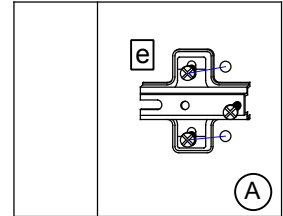
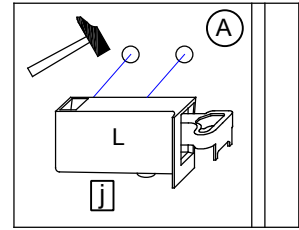
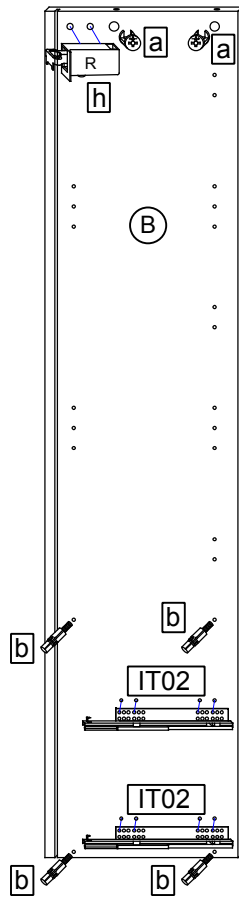
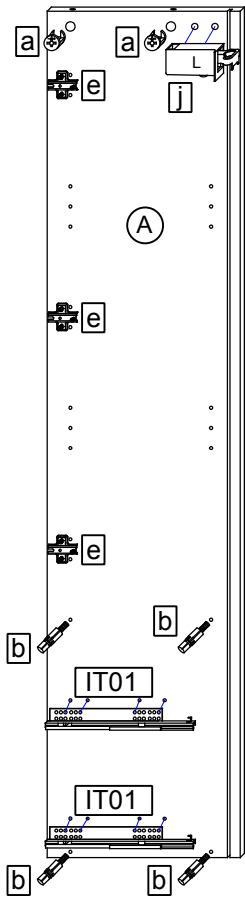
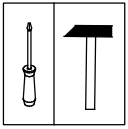

2.

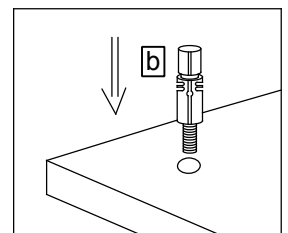
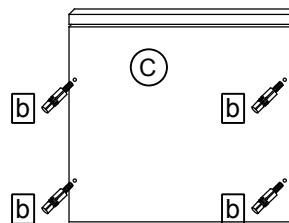
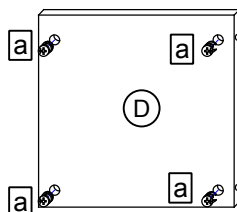
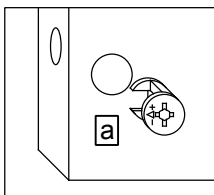
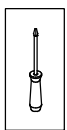

3.

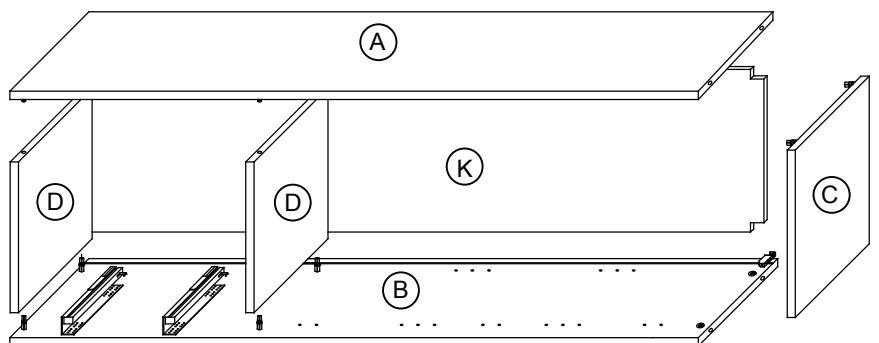
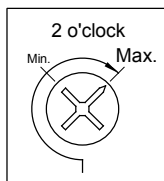
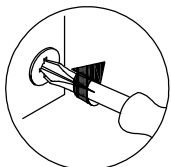
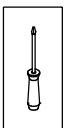

4.

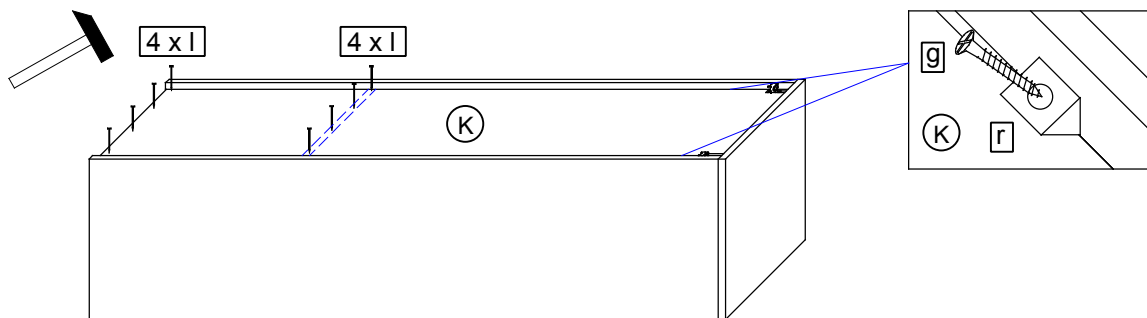
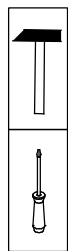

5.

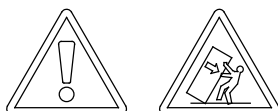
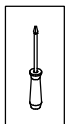

- T9 Lassen Sie den Schrank nur durch fachkundige Personen mit für die Wand geeignetem Montagematerialien montieren.
- T6 Die Schrankaufhänger dienen zur Kippsicherung des Schrankes und müssen grundsätzlich montiert werden.

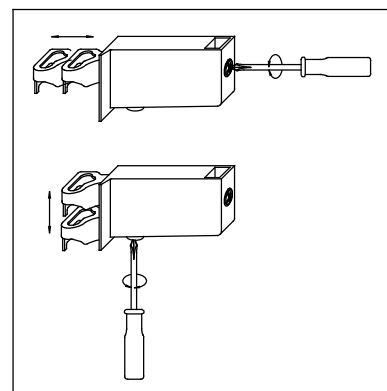
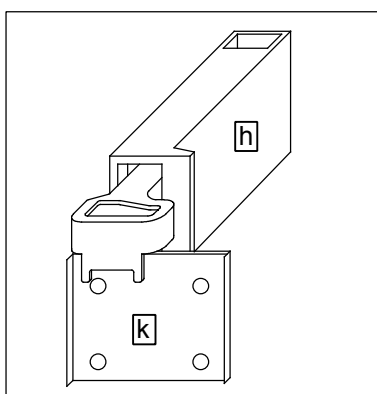
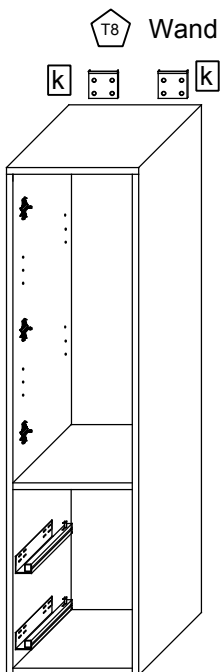
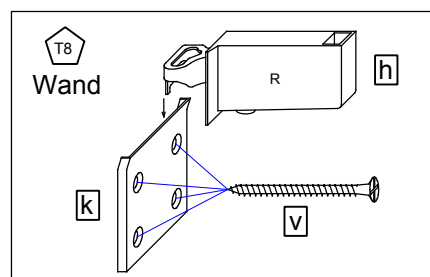

6.

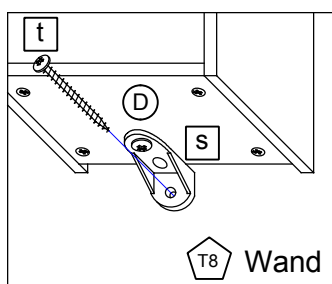
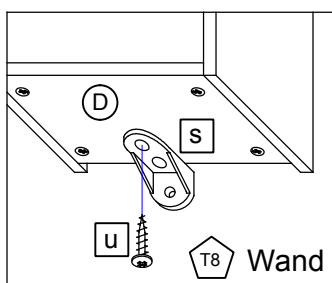
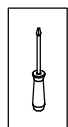

7.

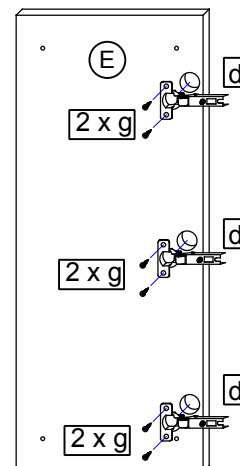
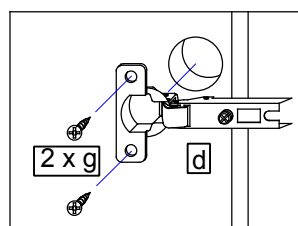
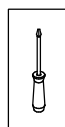

8.

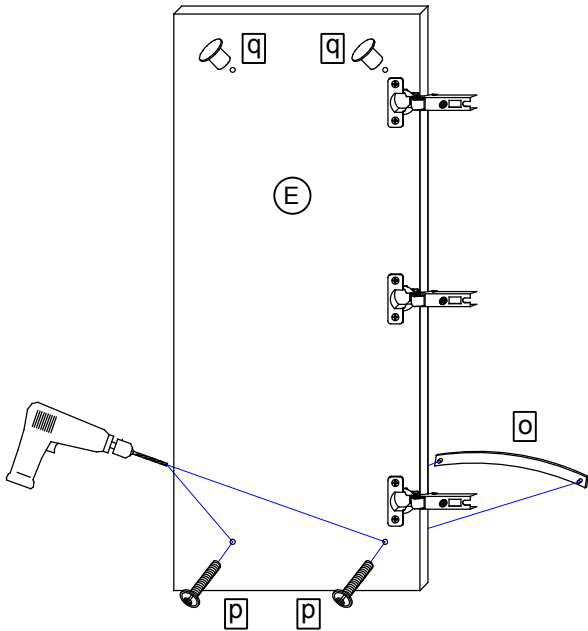
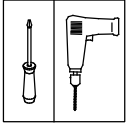

8.1

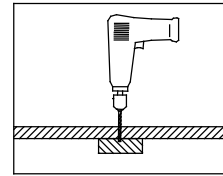
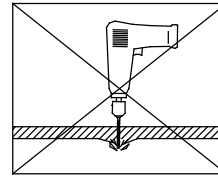

8.2

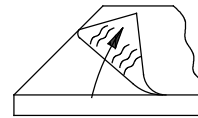

Bei Hochglanz-Fronten bitte erst die Schutzfolie entfernen und dann den Griff montieren!

8.3

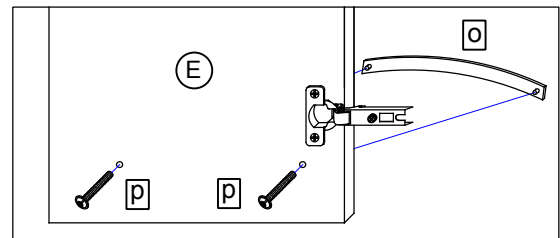

9.

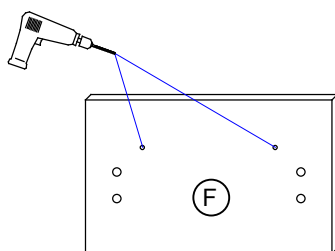
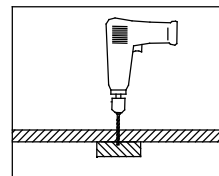
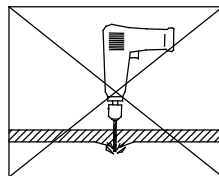
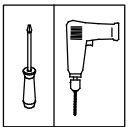

IT09

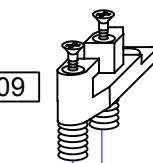

IT09

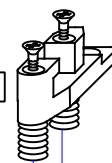

F

10.

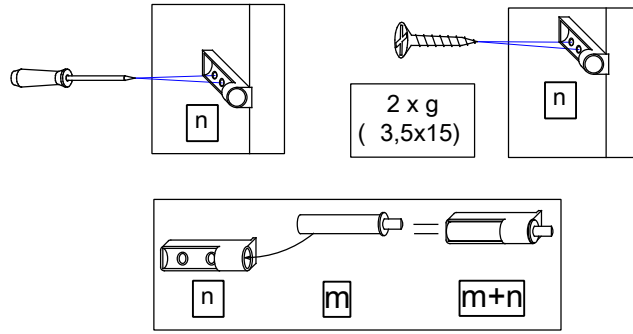
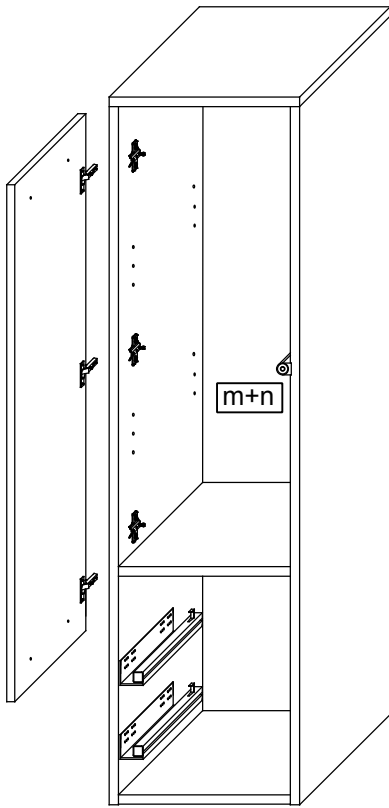
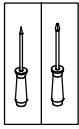

Bei Türmontage das Scharnier einhängen, bis Anschlag öffnen und anschließend festschrauben.

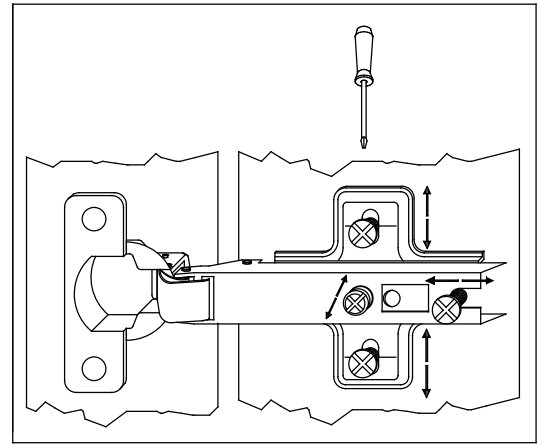
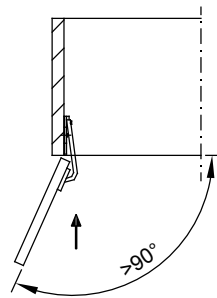

11.

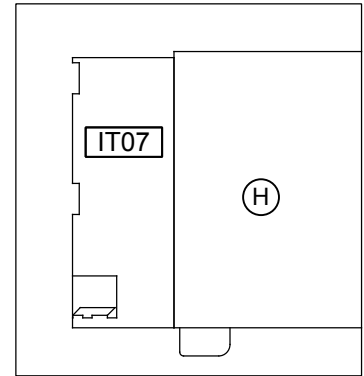
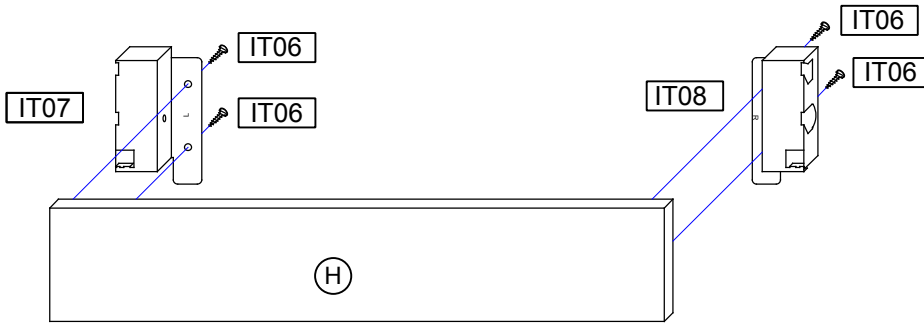
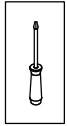

12.

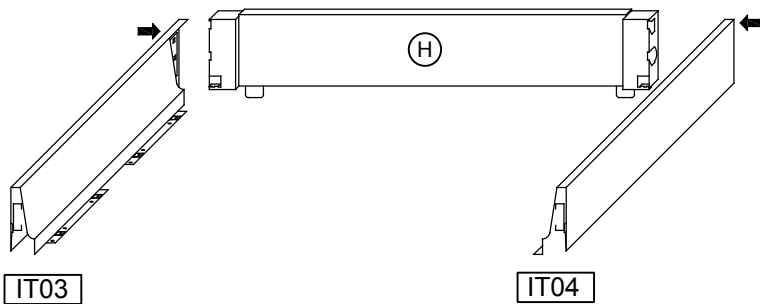

13.

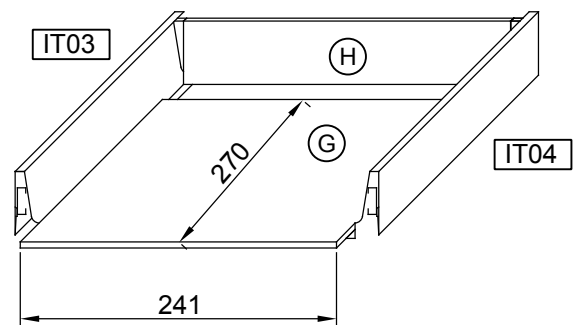

14.

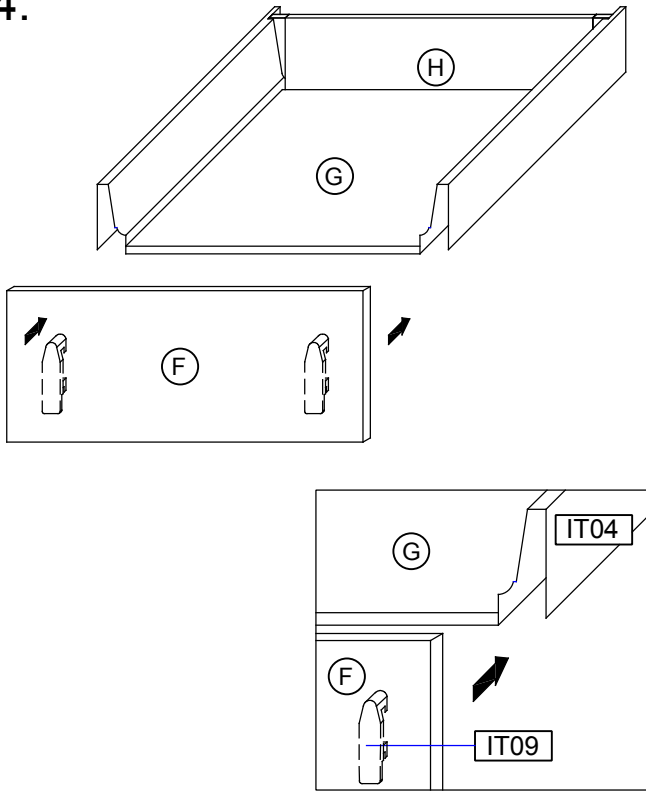

15.

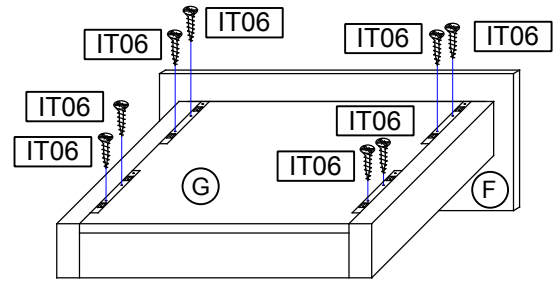
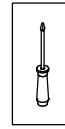

16.

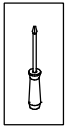

Bei Hochglanz-Fronten bitte erst die Schutzfolie entfernen und dann den Griff montieren!

16.1

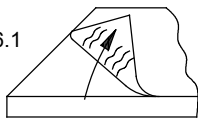

16.2

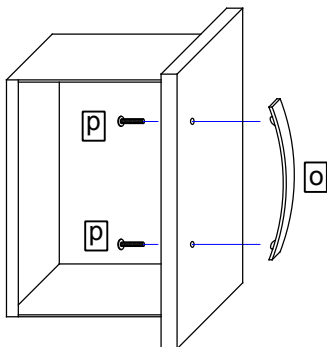

17.

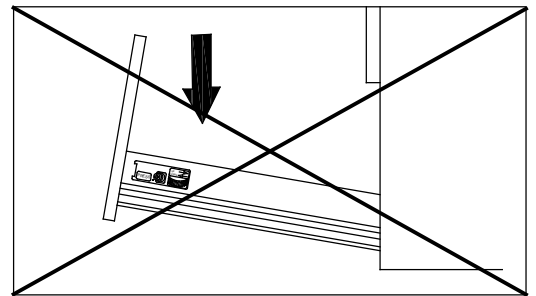
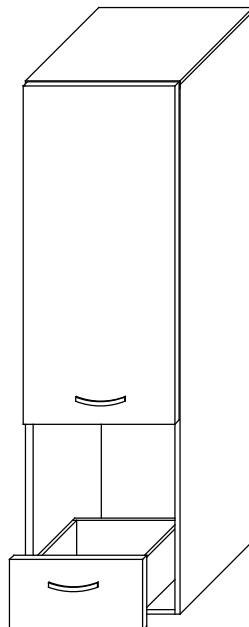

17.1

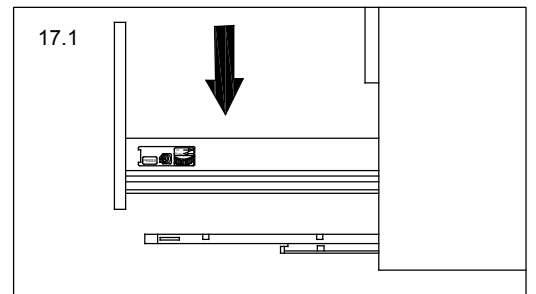

17.2

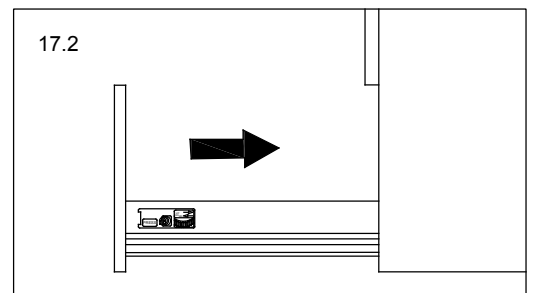

18.

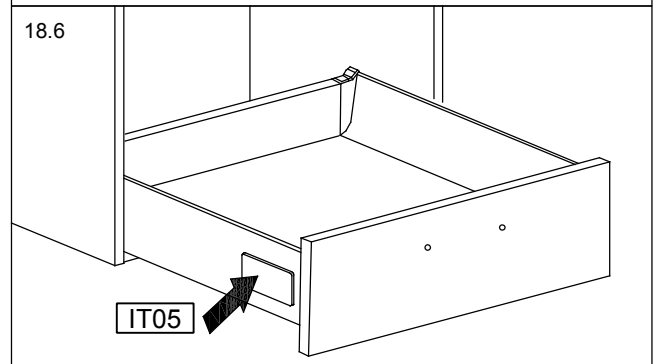
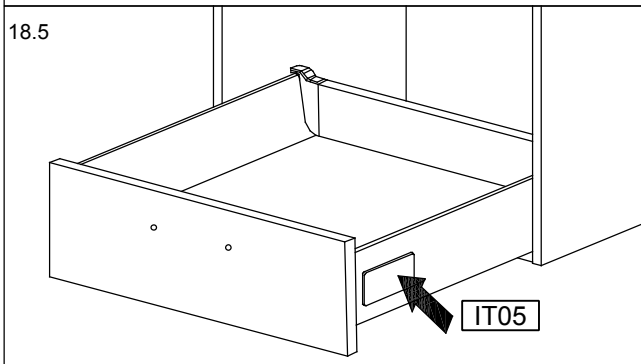
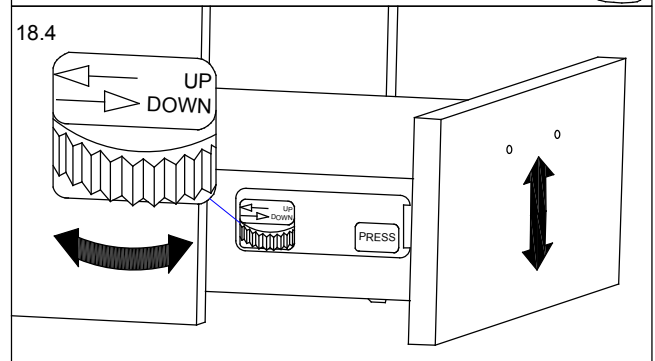
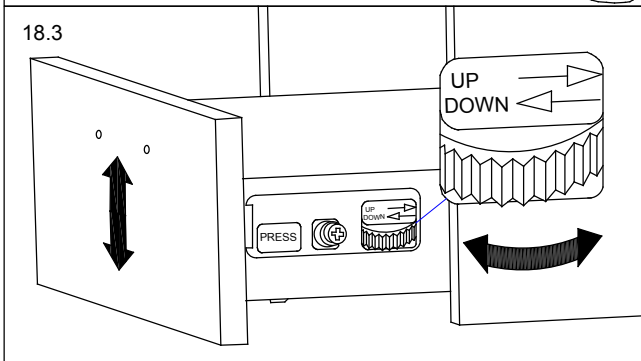
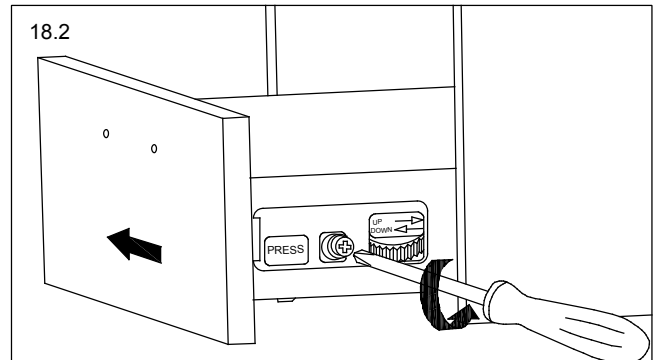
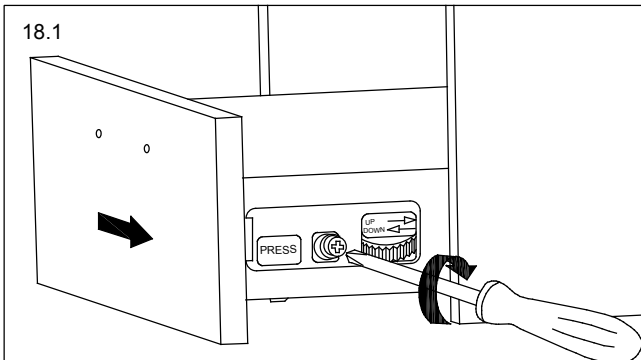
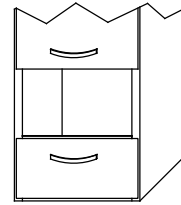
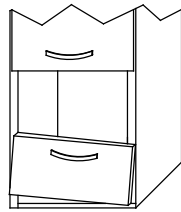
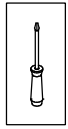

19.

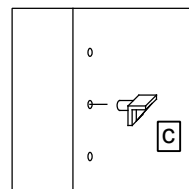
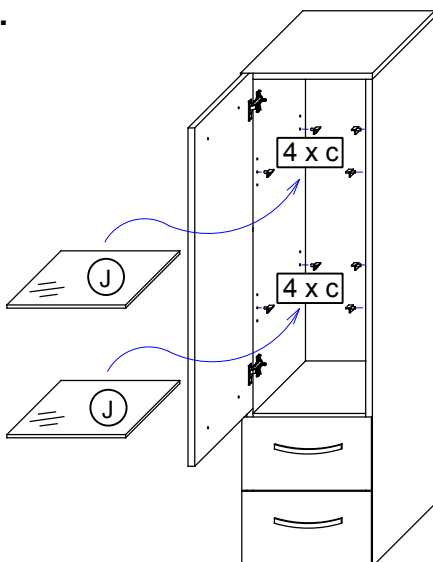

T12 Das Möbel bitte nur mit einem feuchten Tuch reinigen.

# pelipal

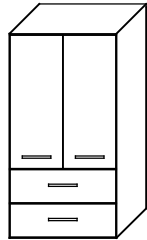

MOT-NZ0238S1 A4  
Datum 02/09/19

3\_\_-015056

9\_\_-015056

T1

Bitte unbedingt ausfüllen!

Name -----  
Strasse -----  
PLZ ----- Ort -----  
Tel. -----

T2

Sehr geehrte Kunden,  
wir freuen uns, dass Sie sich für ein Produkt aus dem Hause Pelipal entschieden haben. Sollte es trotz aller Bemühungen unsererseits, Ihnen ein qualitativ hochwertiges Möbelstück zu liefern, zu Fehlteilen kommen, schicken Sie bitte dieses ausgefüllte Blatt an

Fax.: +49 3443/434350

E-Mail: [ersatzteile@pelipal.de](mailto:ersatzteile@pelipal.de)

Bitte beachten Sie, dass Bauteile über 800mm Länge und 350mm Breite direkt bei Ihrem Möbelhändler zu beanstanden sind. Zur Reklamationsbearbeitung ist es unbedingt erforderlich **die Artikelnummer des Schrankes**, welche auf dem Etikett ersichtlich ist und den Markt, wo das Möbel erworben wurde anzugeben. Außerdem tragen Sie unten bitte die benötigte Stückzahl ein. Viel Spaß mit Ihrem neuen Badmöbel!

Ihr Pelipal Team

-----

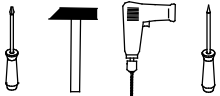

T3

Für den Zusammenbau sind 2 Personen erforderlich.





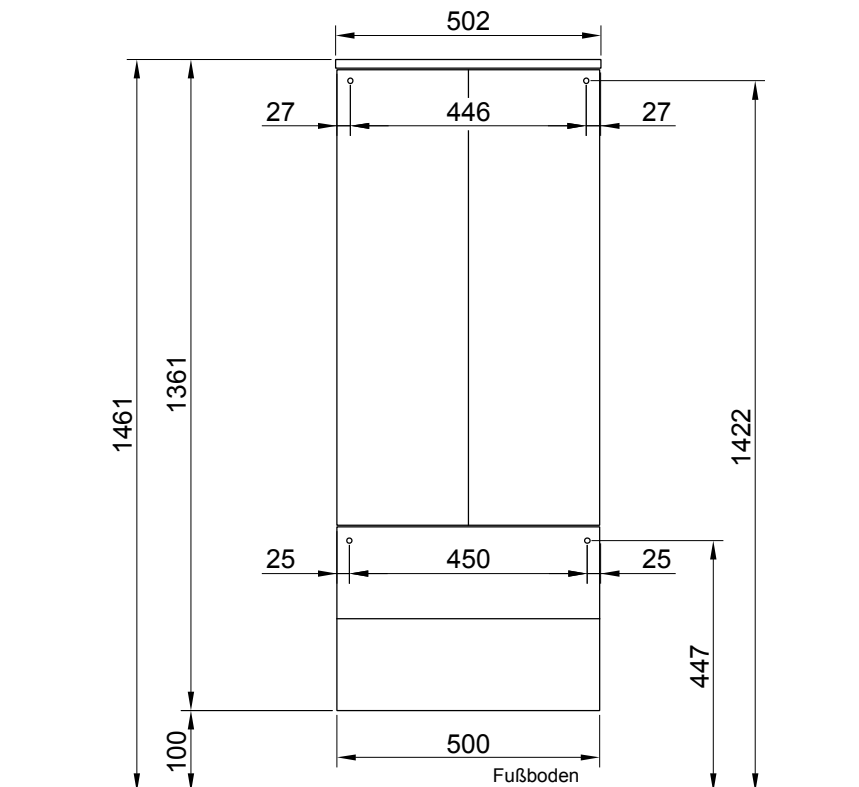





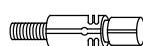

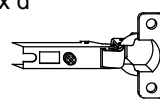
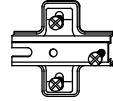

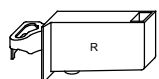
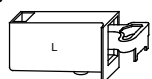

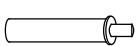

T4

Montage-Richtzeit 3 Stunden

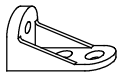
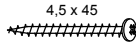

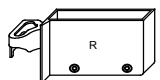
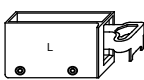
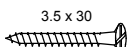
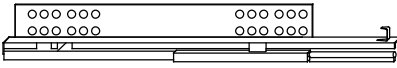
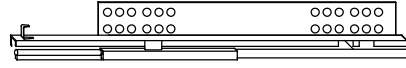
Die Maßangabe der Höhe ist nicht bindend!

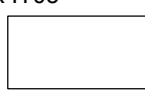
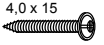
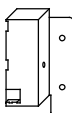
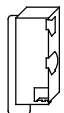

12 x a  EXZENTER-000015	Stück	12 x b  DUEB-SMD-000005	Stück	8 x c  TRAE-001-000020	Stück	6 x d  TBD-35-115X00	Stück	6 x e  ZPL-003X004	Stück
16 x f  SCH-KA-063X011	Stück	20 x g  SCH-SPA-035X015	Stück	1 x h  AUF-001-000080	Stück	1 x j  AUF-001-000090	Stück	4 x k  AUF-001-000020	Stück
6 x l  NAGEL-025X001	Stück	2 x m  TUER-DAEM-000010	Stück	2 x n  TUER-ADA-000010	Stück	4 x o  Griff	Stück	8 x p  SCH-RDK-045X045	Stück
4 x q  ADK-AL1-005X008	Stück	4 x r  RWD-KEI-000060	Stück	1 x s  VBD-000020	Stück	1 x t  SCH-RDK-045X045	Stück	1 x u  SCH-RDK-040X015	Stück
1 x v  AUF-001-000085	Stück	1 x w  AUF-001-000095	Stück	4 x x  SCH-SPA-035X030	Stück		Stück		Stück
2 x IT01  KA-260-LI			Stück	2 x IT02  KA-260-RE			Stück		Stück
2 x IT03  ZAR-260-LI			Stück	2 x IT04  ZAR-260-RE			Stück	4 x IT05  ADK-ZAR-ALU	Stück
24 x IT06  SCH-RDK-040X015	Stück	2 x IT07  VBD-ZAR-LI-70	Stück	2 x IT08  VBD-ZAR-RE-70	Stück	4 x IT09  VBD-ZAR-FRO	Stück		Stück

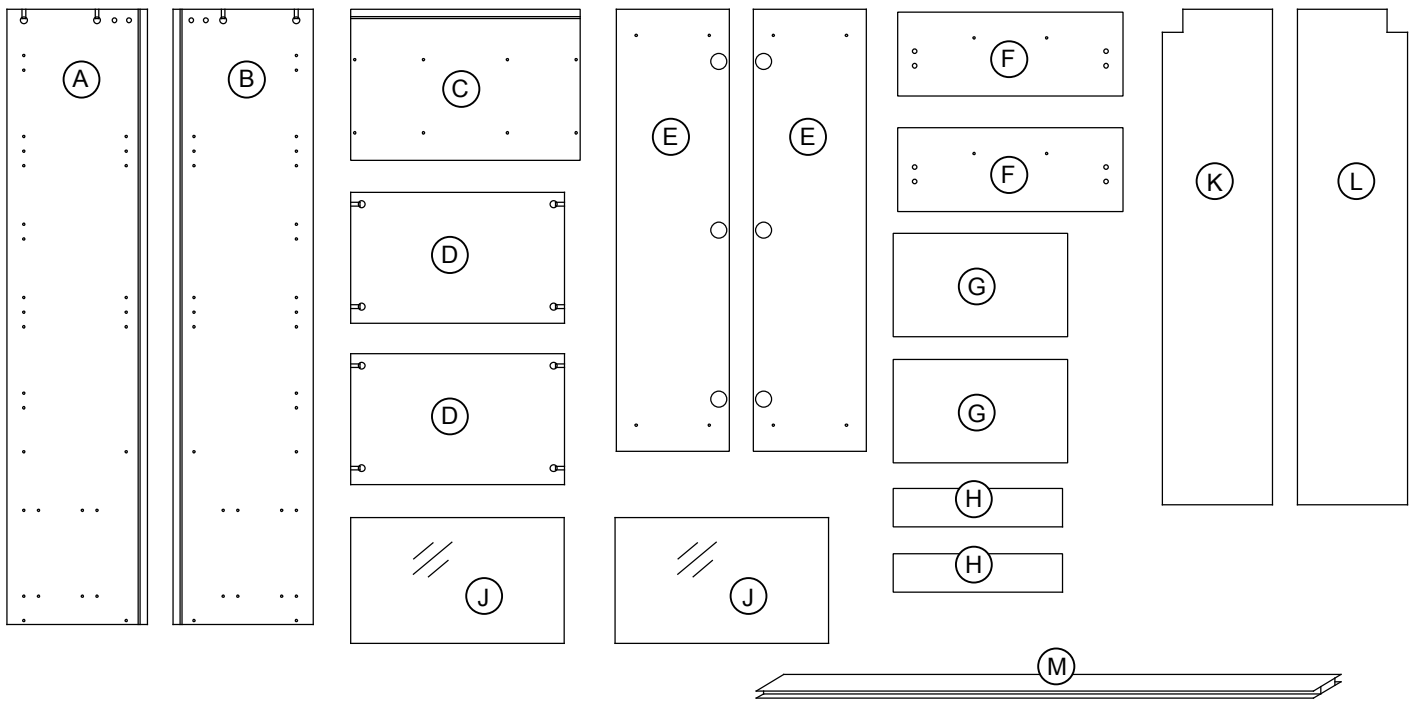

1.

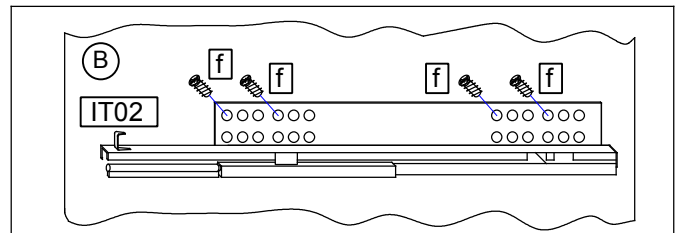
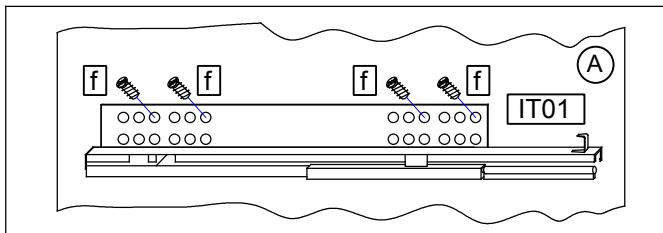
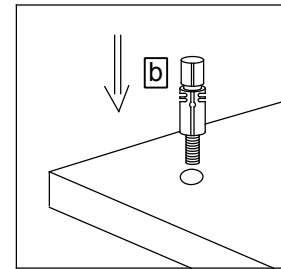
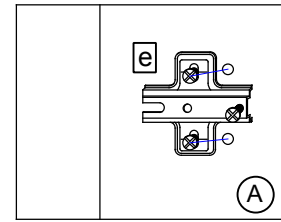
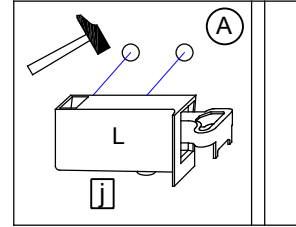
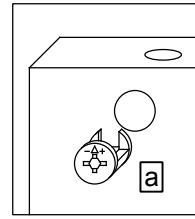
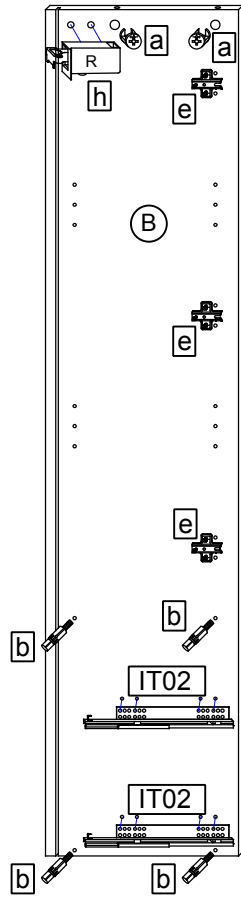
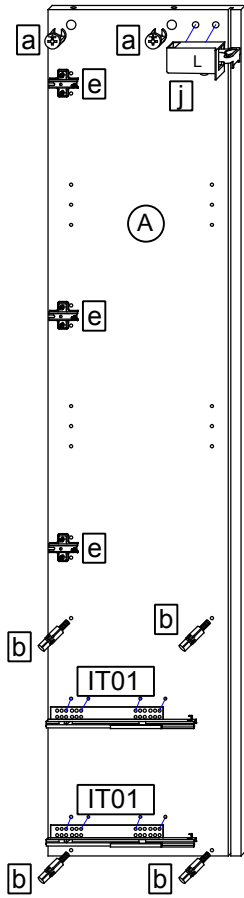
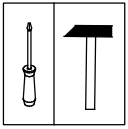

2.

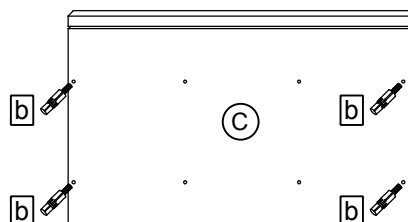
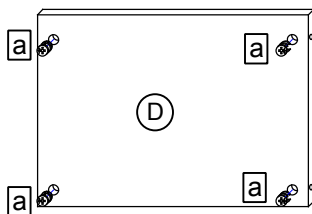
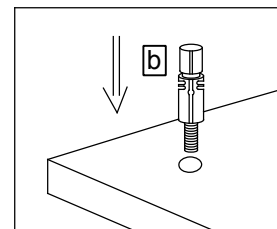
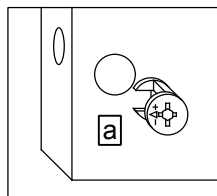
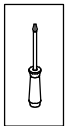

3.

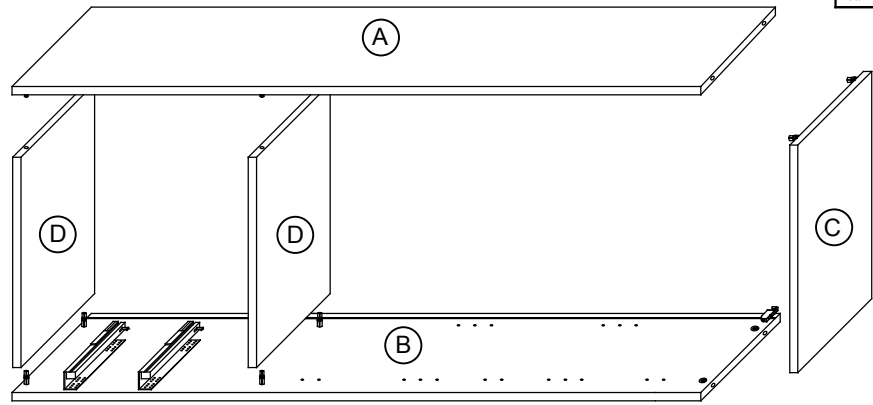
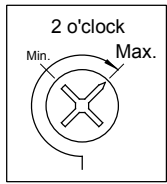
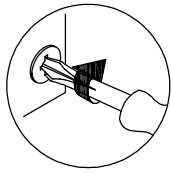
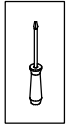

4.

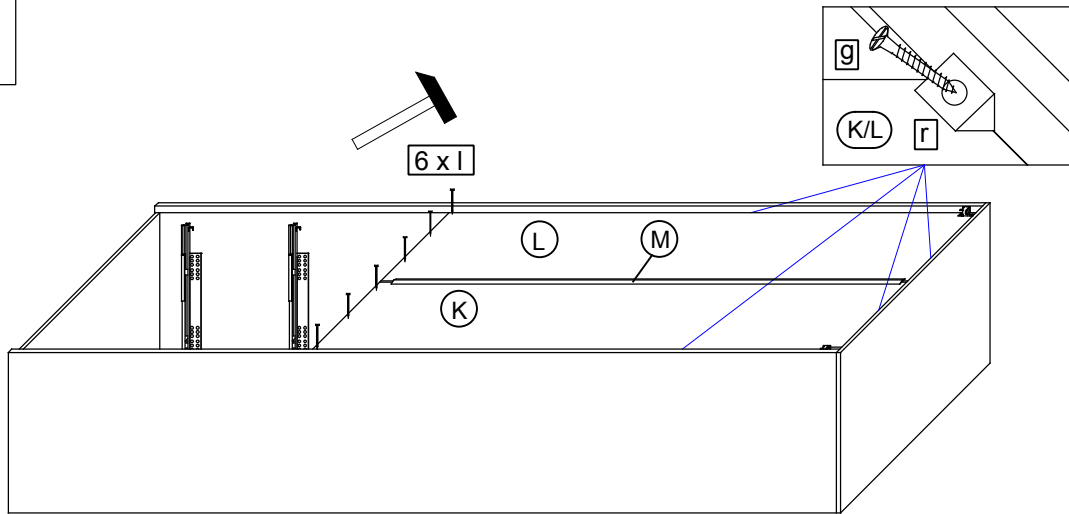
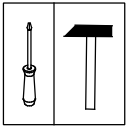

5.

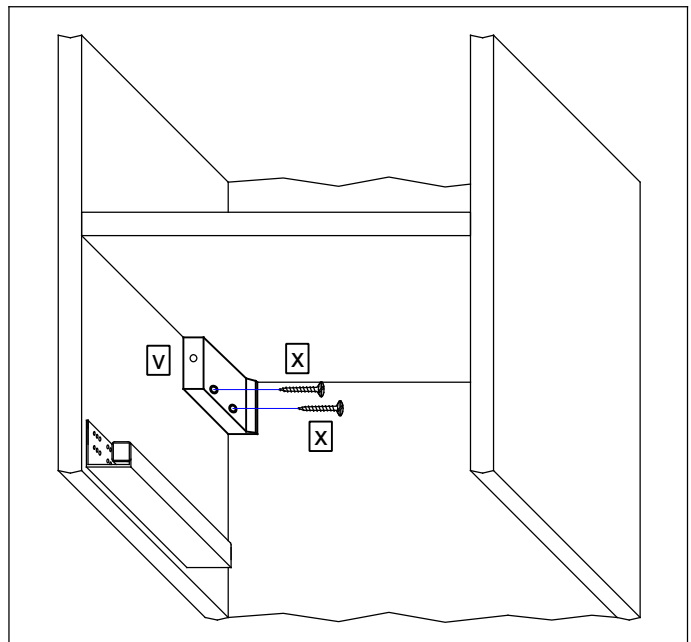
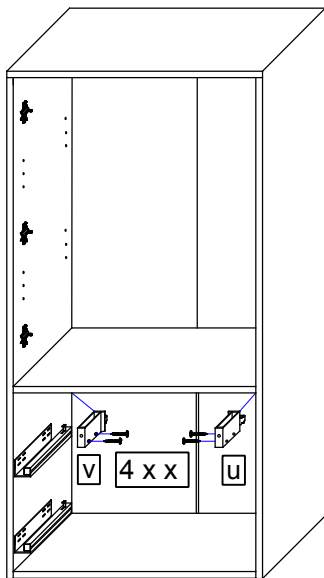
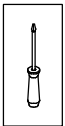

6.

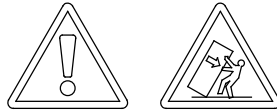
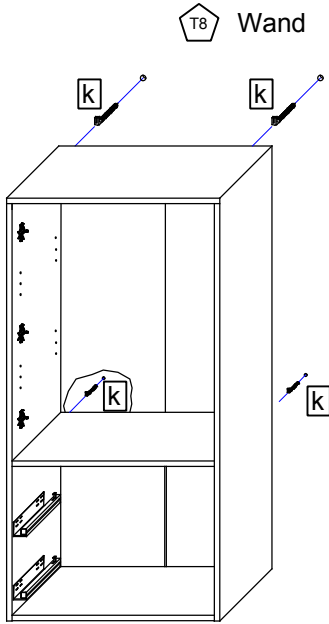
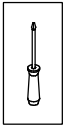

T9 Lassen Sie den Schrank nur durch fachkundige Personen mit für die Wand geeignetem Montagematerialien montieren.

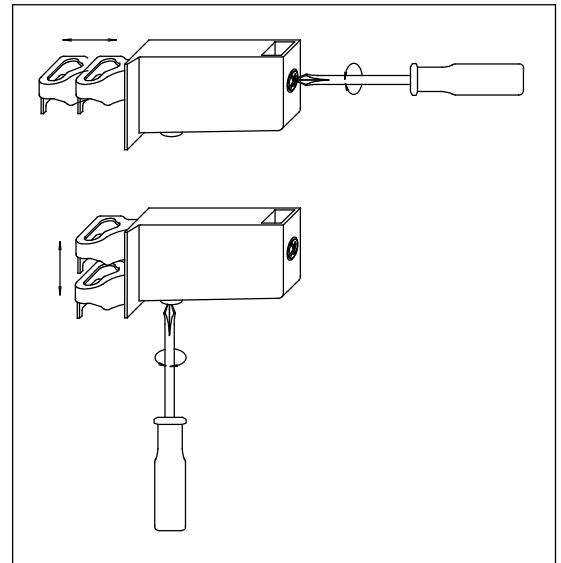
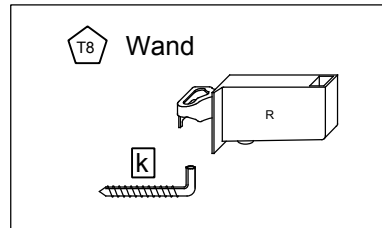

7.

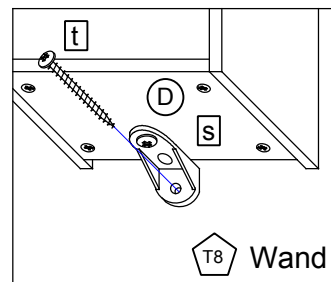
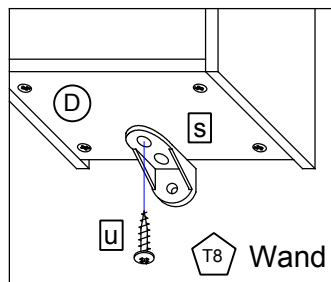
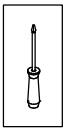

8.

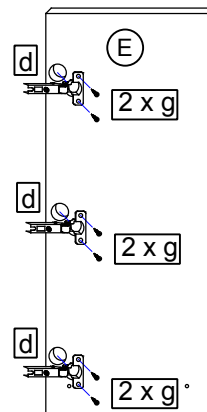
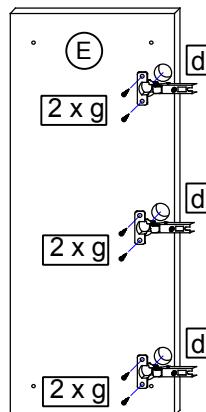
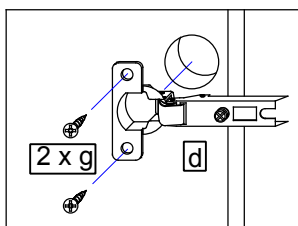
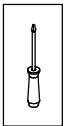

9.

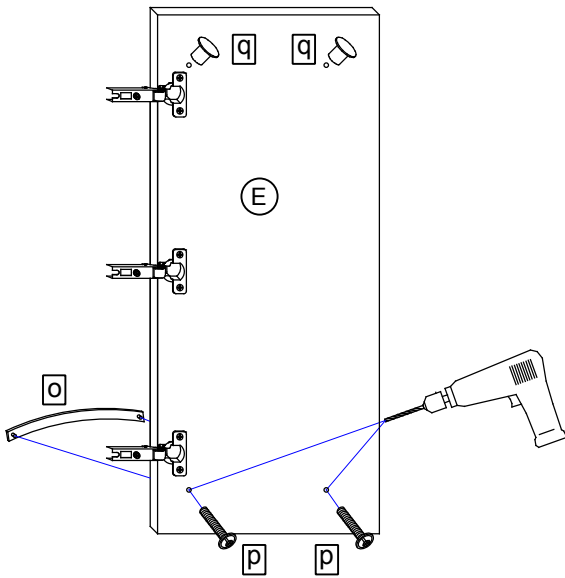
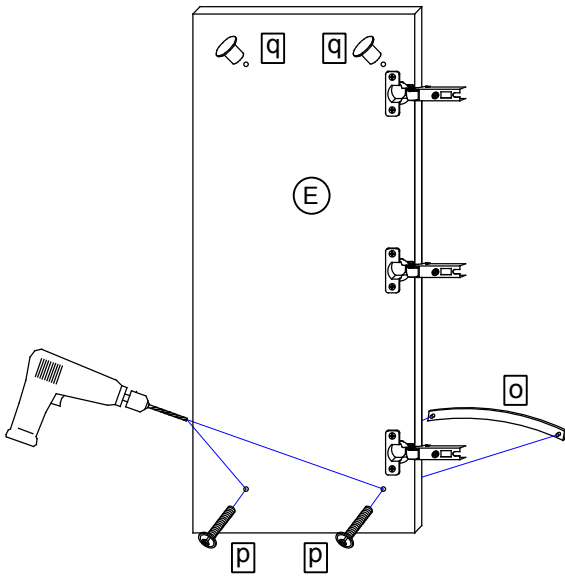
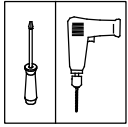

9.1

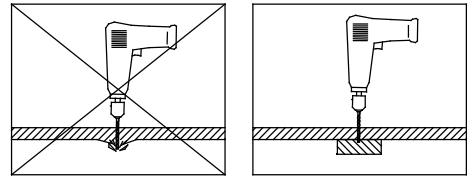

9.2

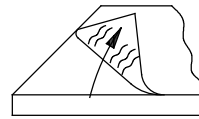

Bei Hochglanz-Fronten bitte erst die Schutzfolie entfernen und dann den Griff montieren!

9.3

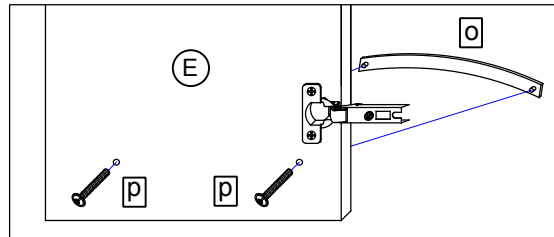

10.

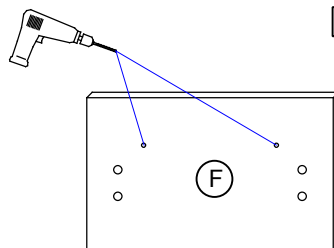
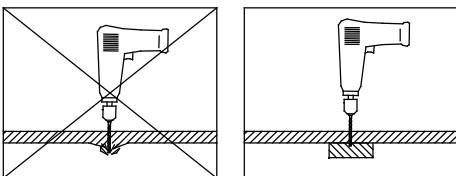
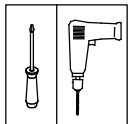

IT09

IT09

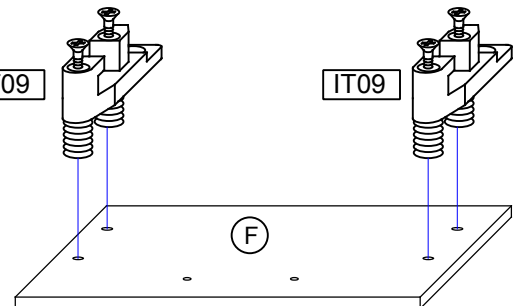

11.

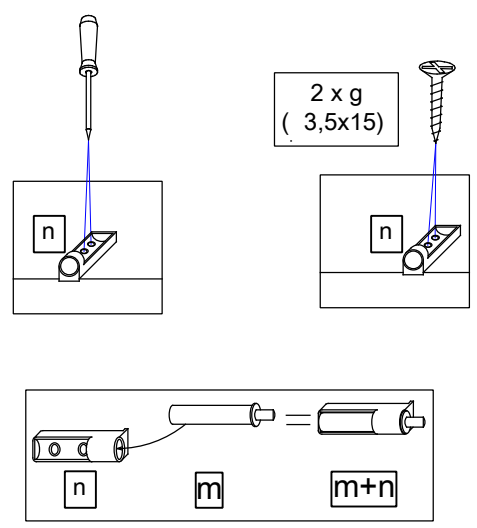
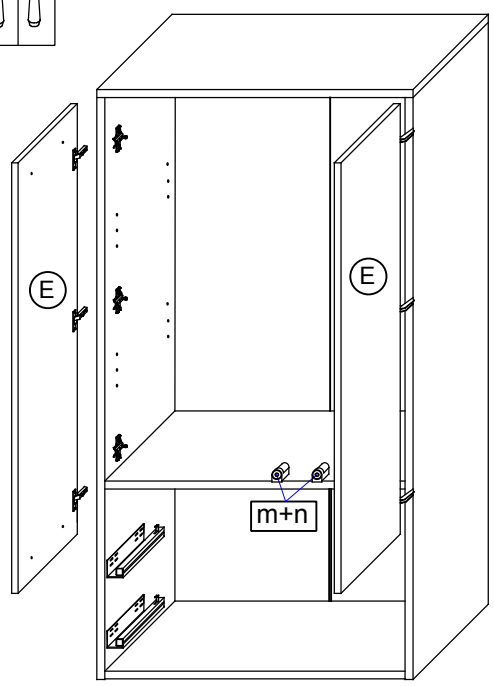
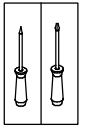

Bei Türmontage das Scharnier einhängen, bis Anschlag öffnen und anschließend festschrauben.

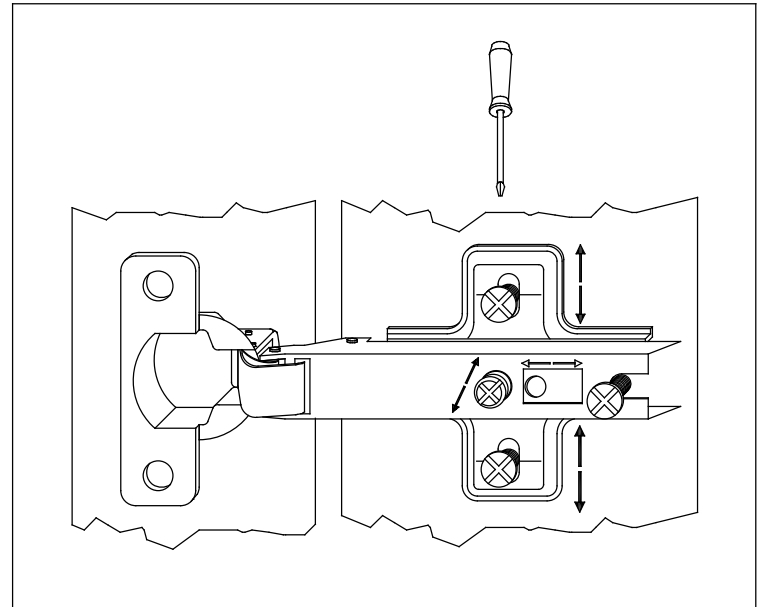
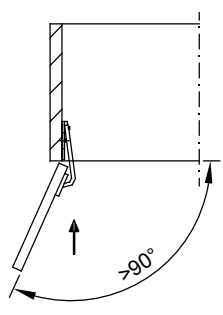

12.

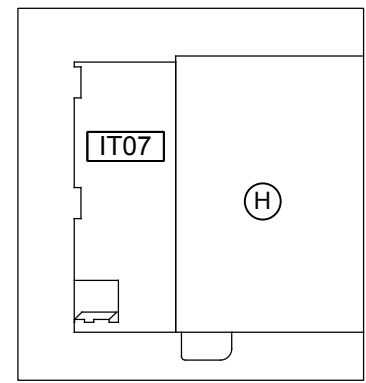
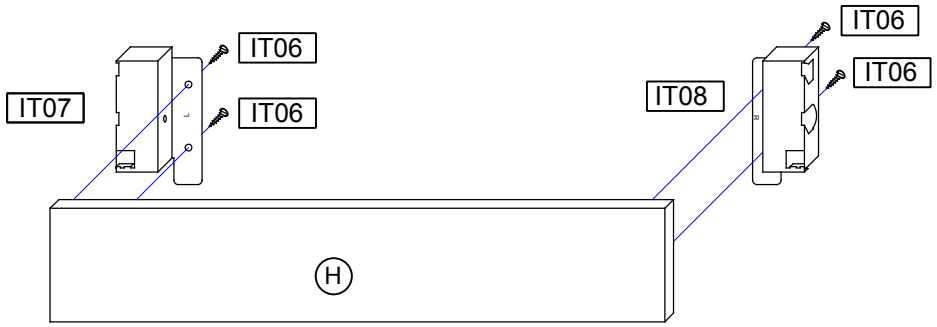
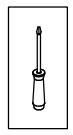

13.

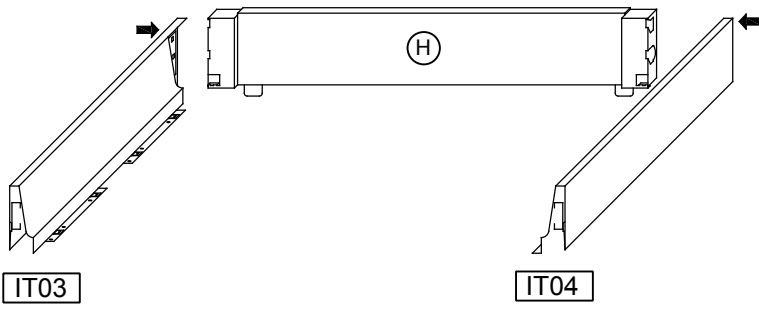

14.

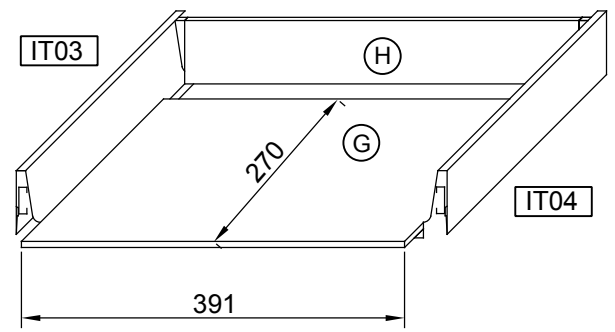

15.

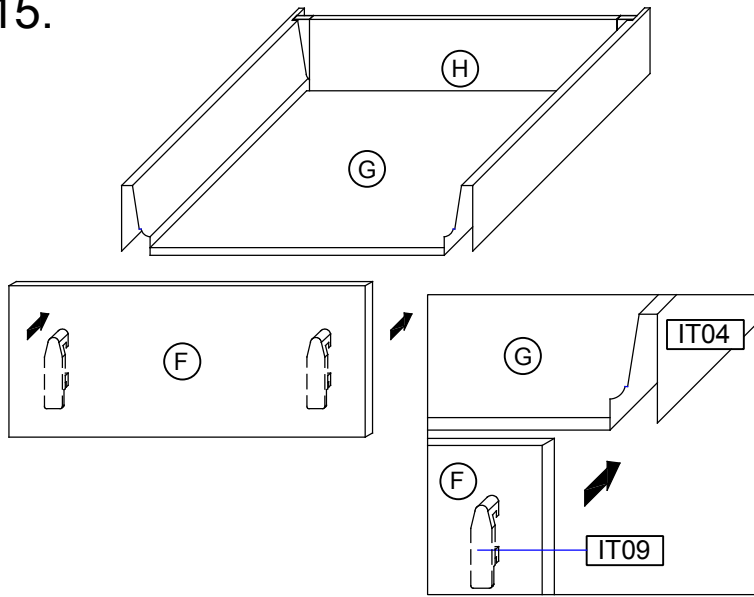

16.

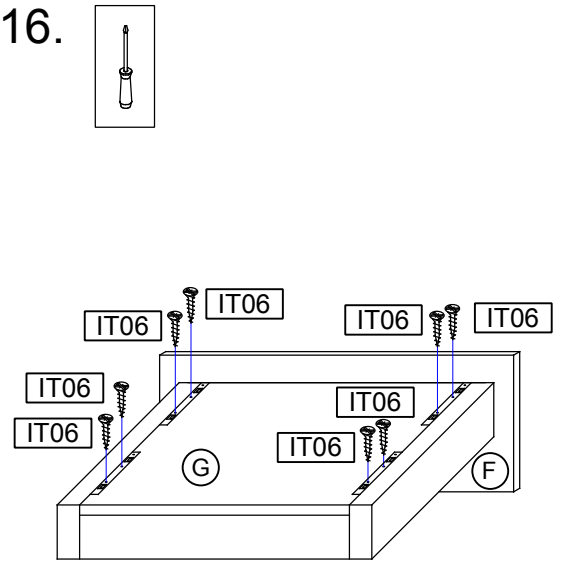

17

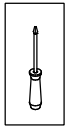

T10

Bei Hochglanz-Fronten bitte erst die Schutzfolie entfernen und dann den Griff montieren!

17.1

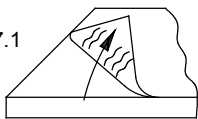

17.2

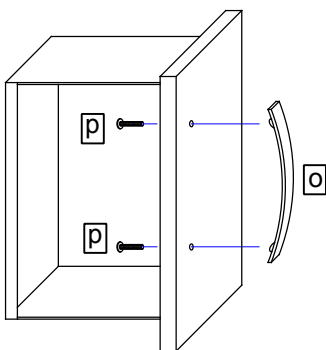

18.

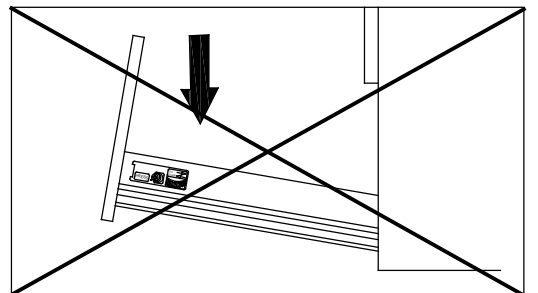
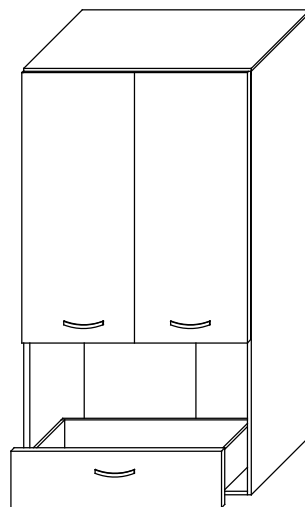

18.1

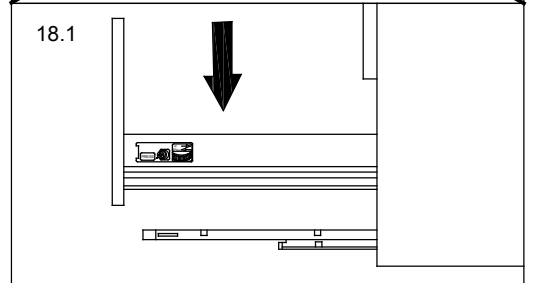

18.2

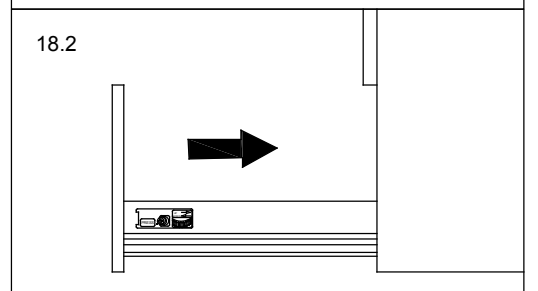

19.

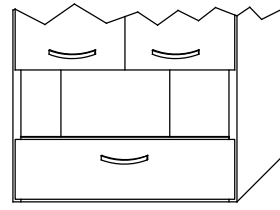
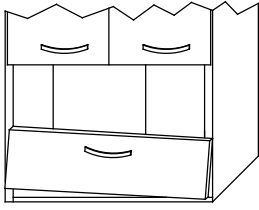
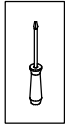

19.1

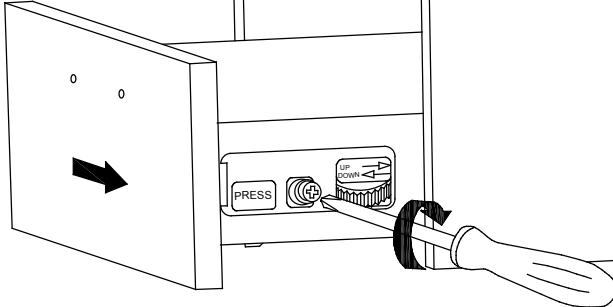

19.2

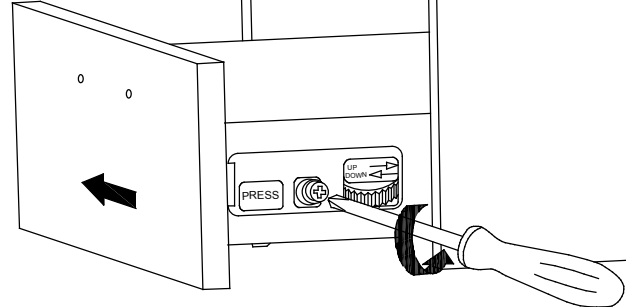

19.3

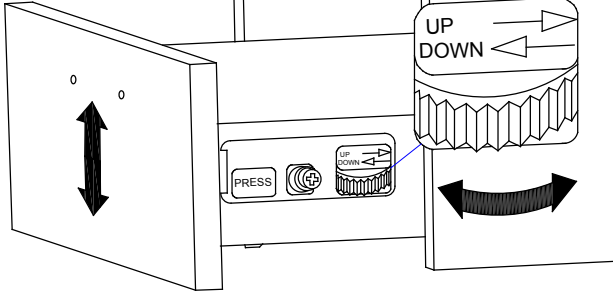

19.4

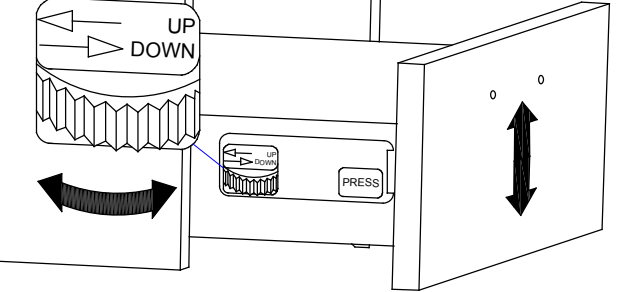

19.5

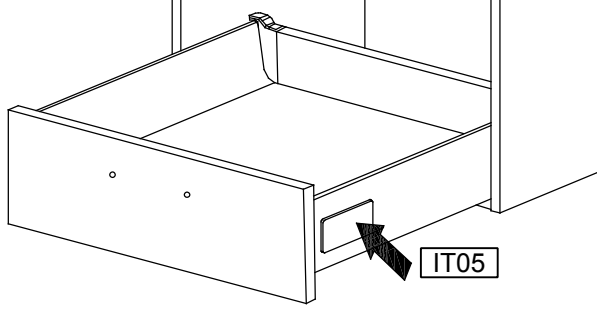

19.6

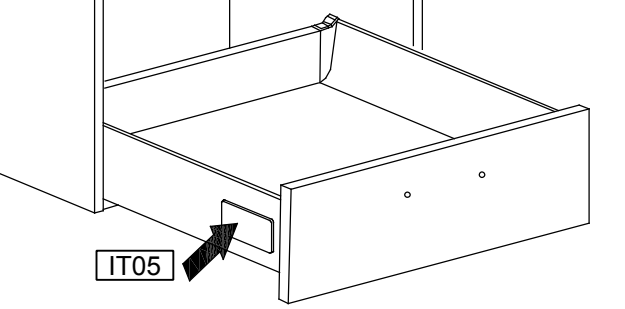

20.

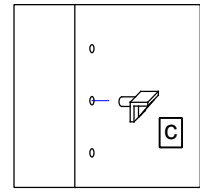
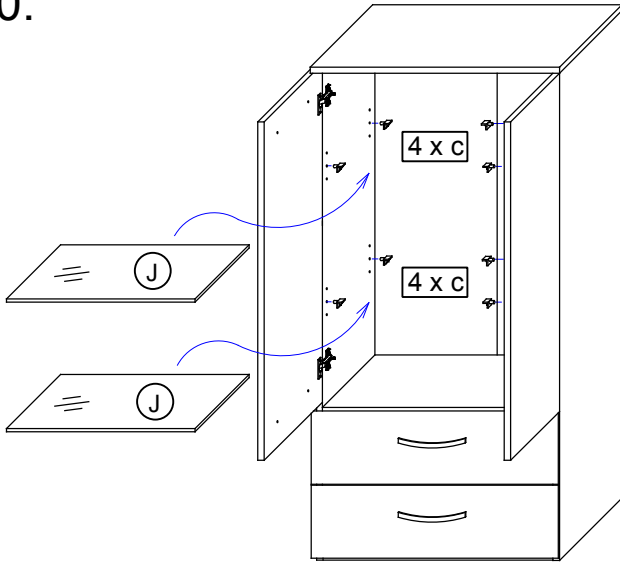

T12 Das Möbel bitte nur mit einem feuchten Tuch reinigen.