

REPC-Nr.:

Service • Assistenza • Dienstverlening • Serwis  
Servis • Szerviz • Сервисная служба

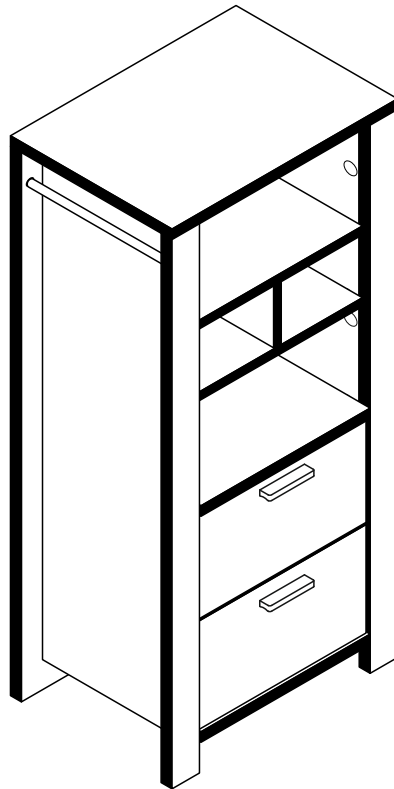

Artikel.-Nr.:

**0444-BS\_02**

Montageanleitung.-Nr.:

**MA1-00164**

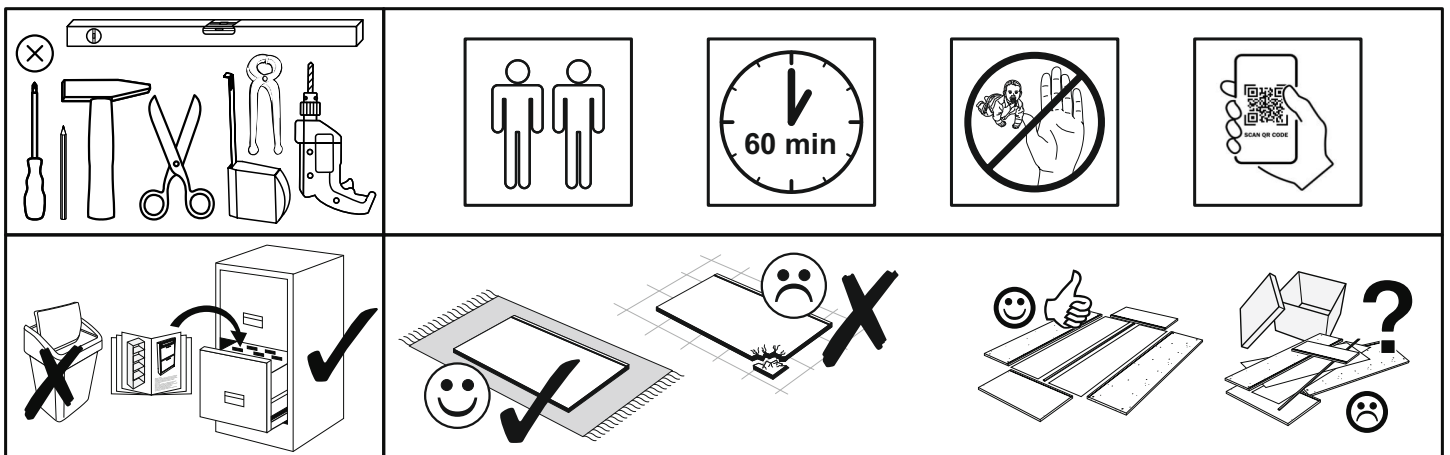

SCAN ME

Das Ersatzteil-Anforderungsformular finden Sie auf  
The replacement parts requisition form you find on  
<https://www.maeusbacher.de/ersatzteile/>

## Beutel 0444-BS\_02 0-12 Colli 2/2

B01-10		B01-30		B01-70		B01-120		B01-175	
8x	6,3x50	20x	3x16	4x	3x30	2x	3,5x45	6x	4,5x60
B01-200		B01-329		B02-08		B02-10		B02-20	
8x	6,3x13	4x	M4x22	8x	h=10mm	30x	h=12mm	38x	
B08-80									
1x									



SCAN ME

## Beutel 0444-BS\_02 0-22 Colli 2/2

B02-103		B05-20		B05-130		B06-440	
8x	8x30	14x		2x	LEIM	2x	

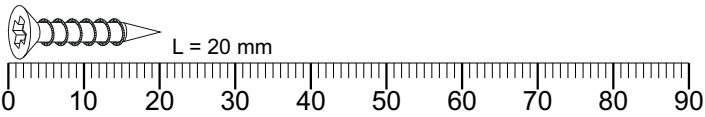

## Colli 1/2

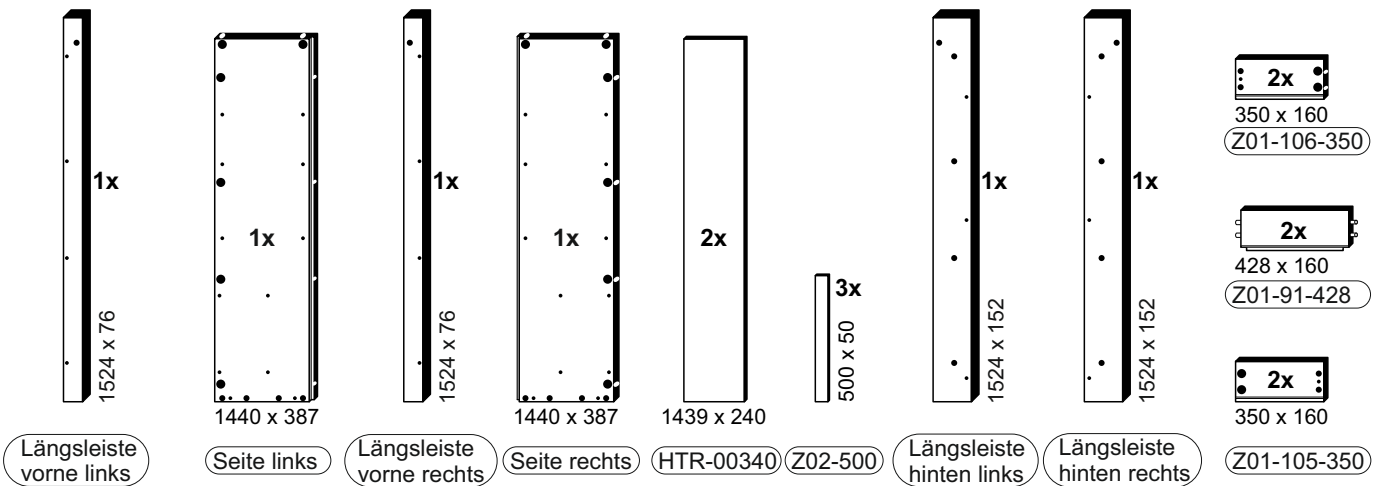

## Colli 2/2

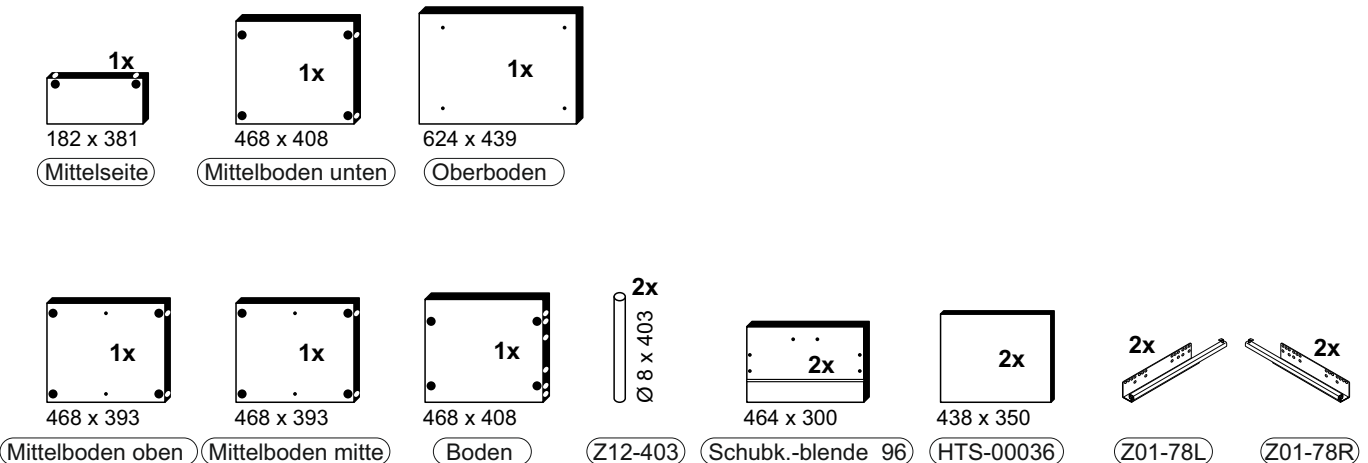

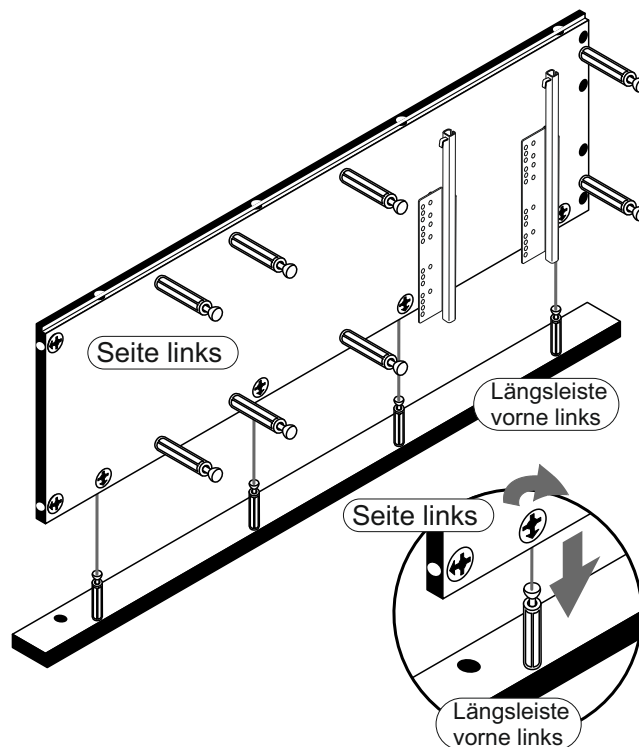
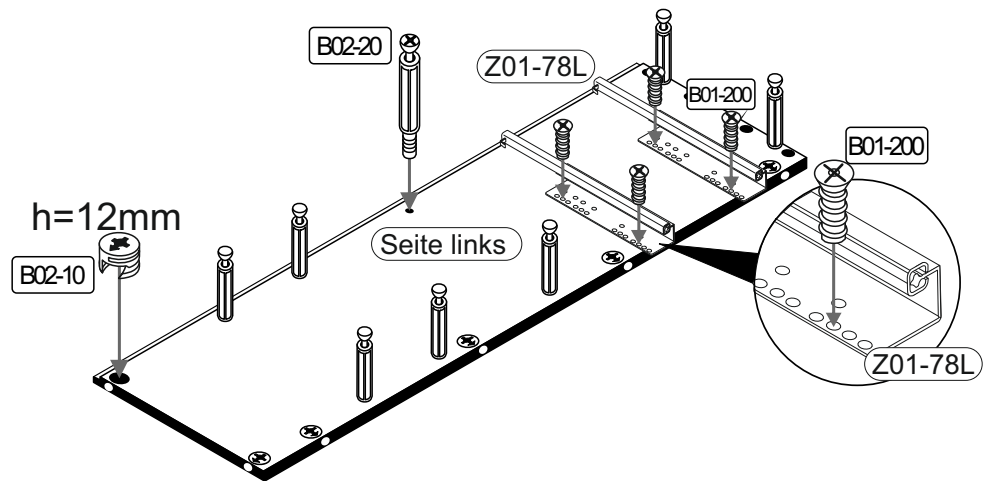
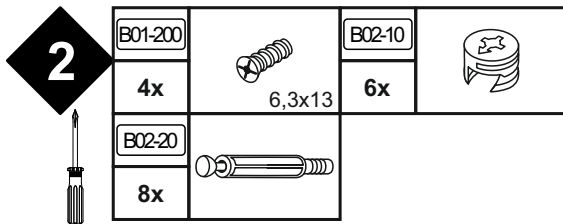
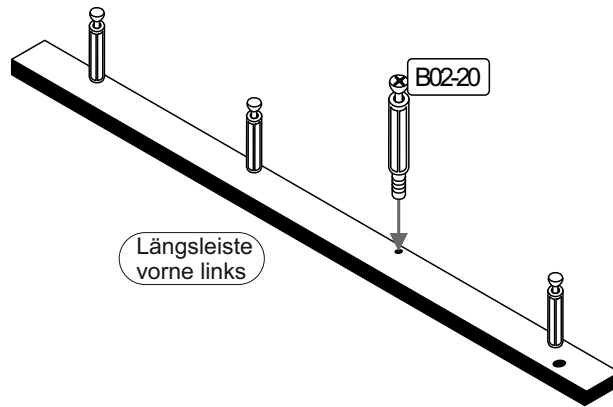
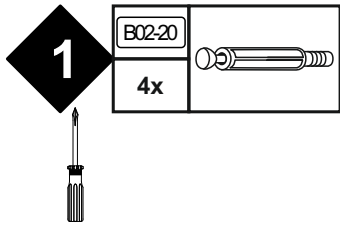

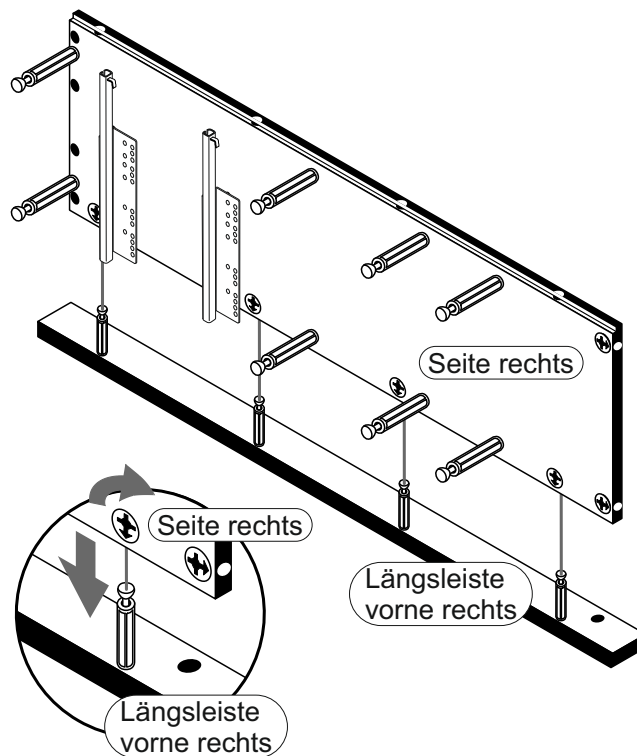
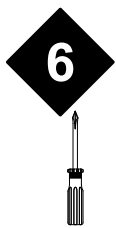
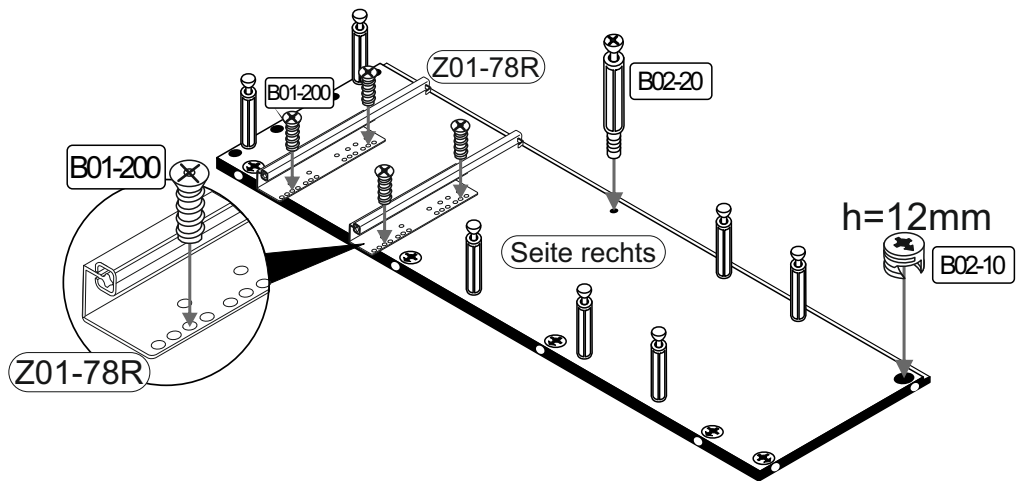
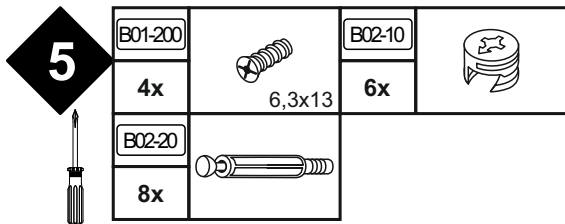
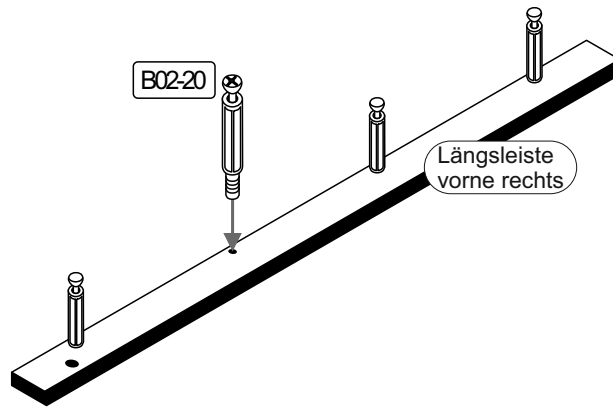
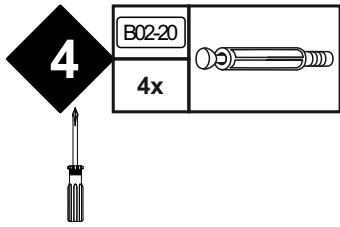

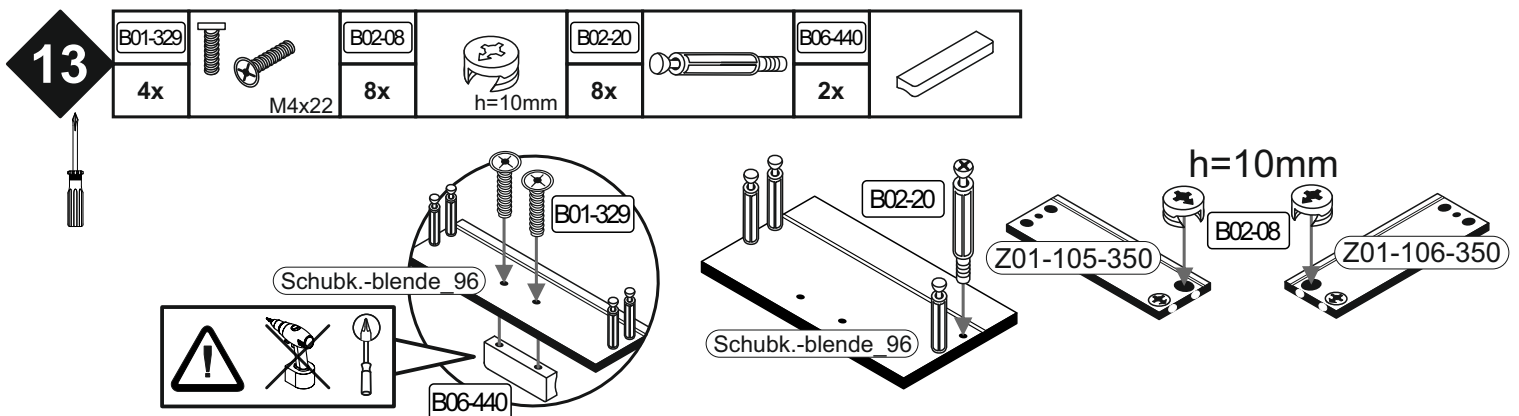
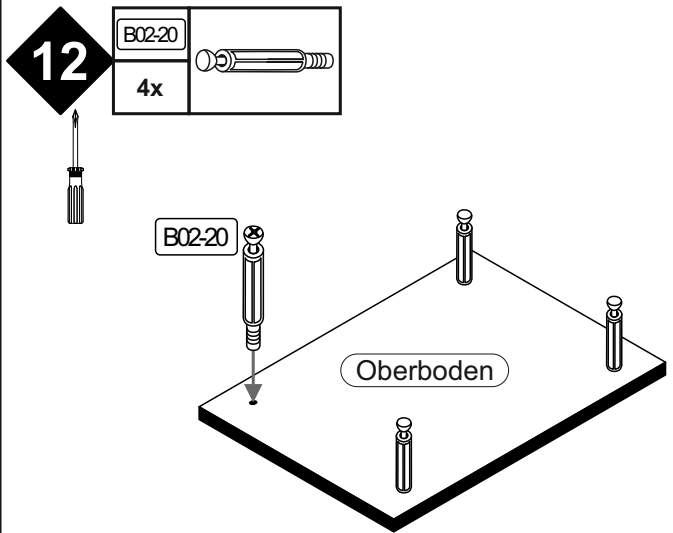
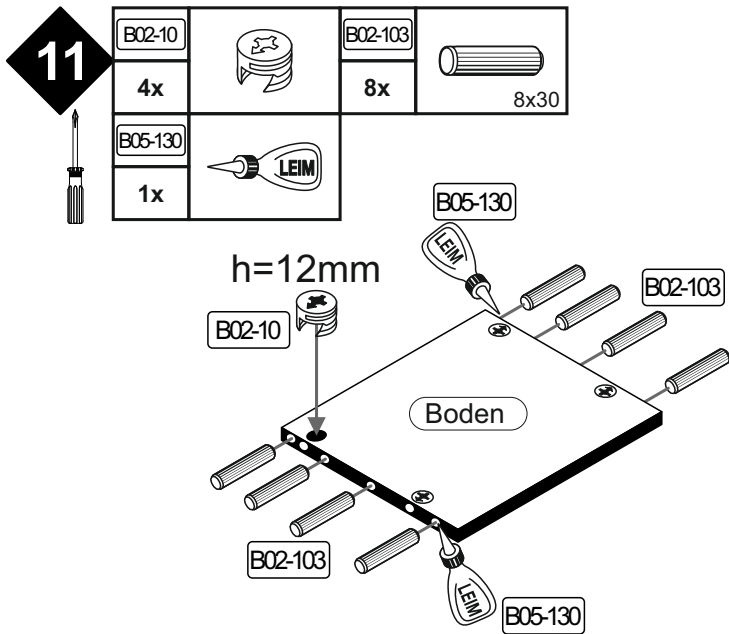
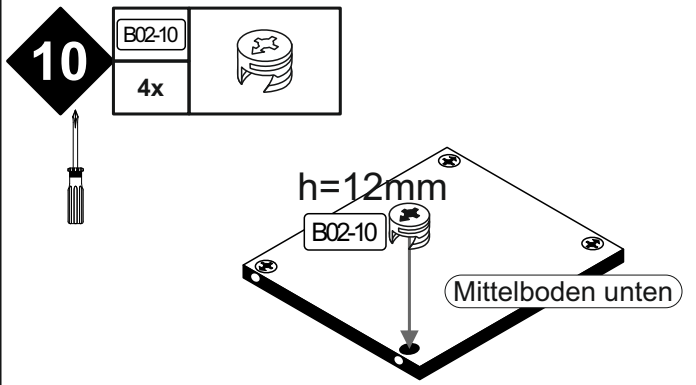
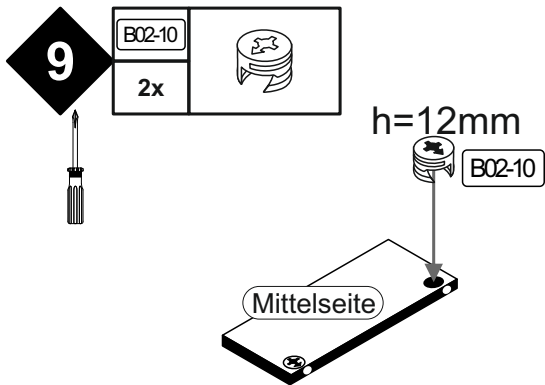
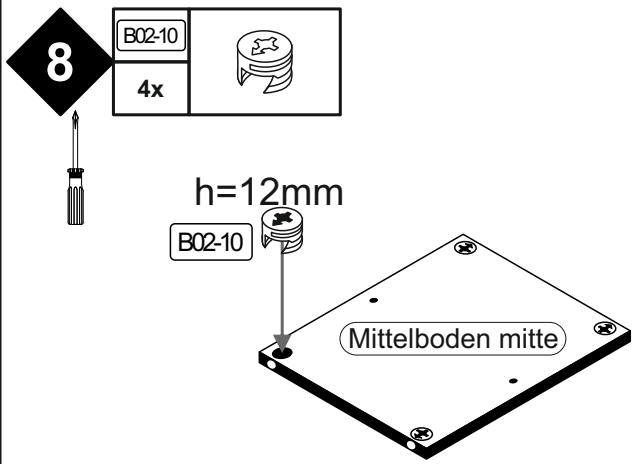
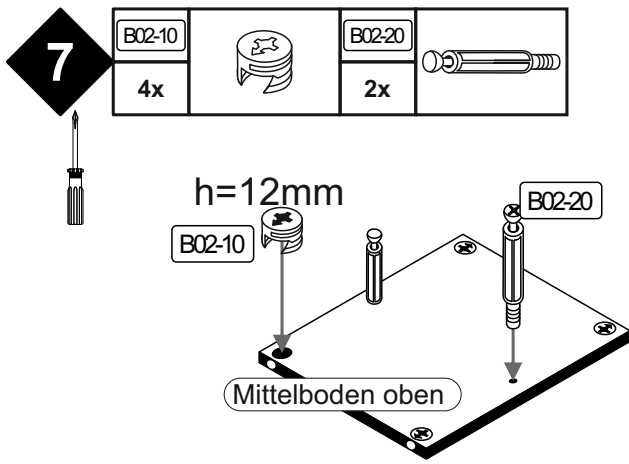

**14**

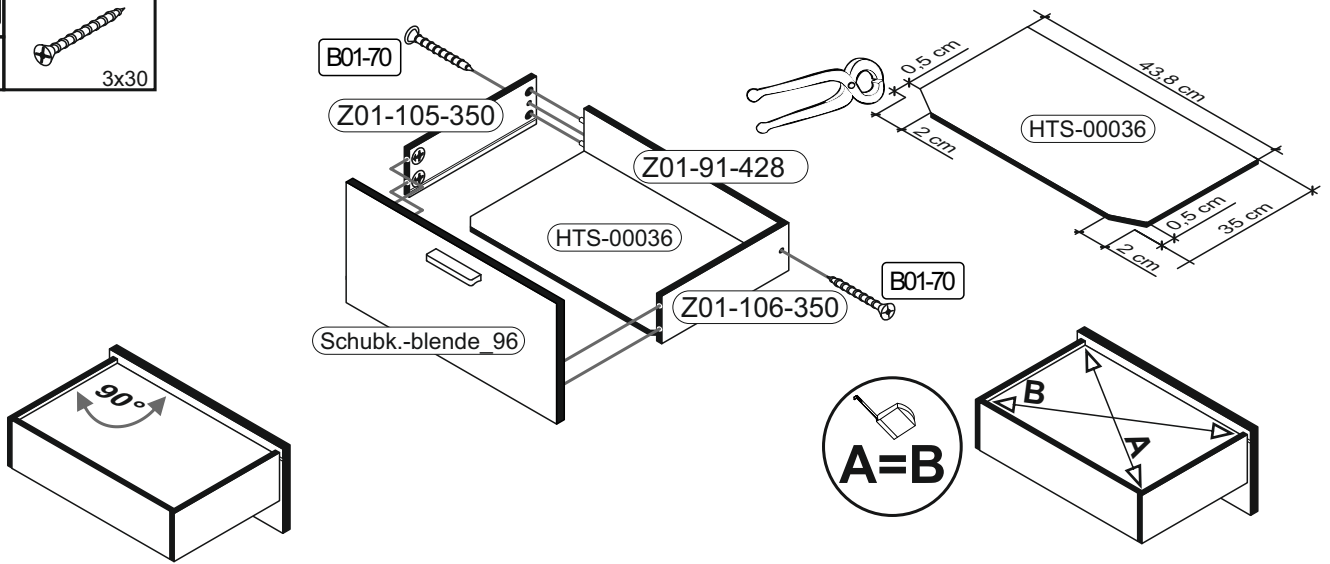

B01-70	
4x	3x30

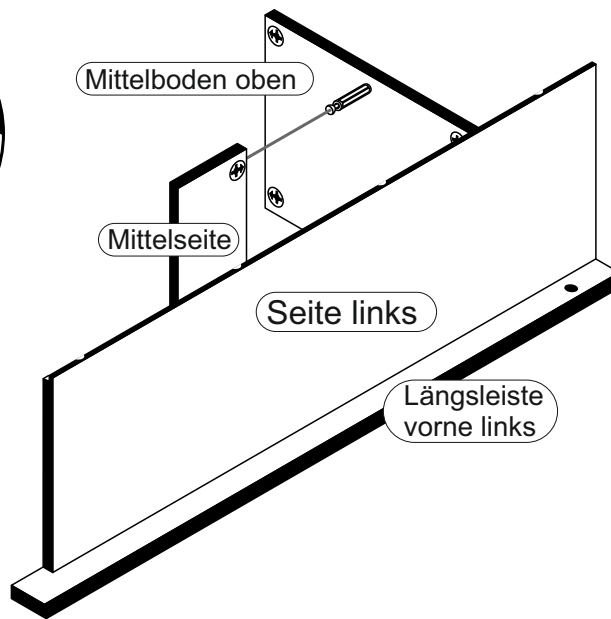
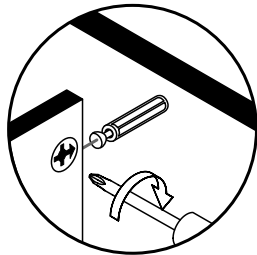

**15**



**16**

B01-120	
2x	3,5x45
B05-130	
1x	LEIM

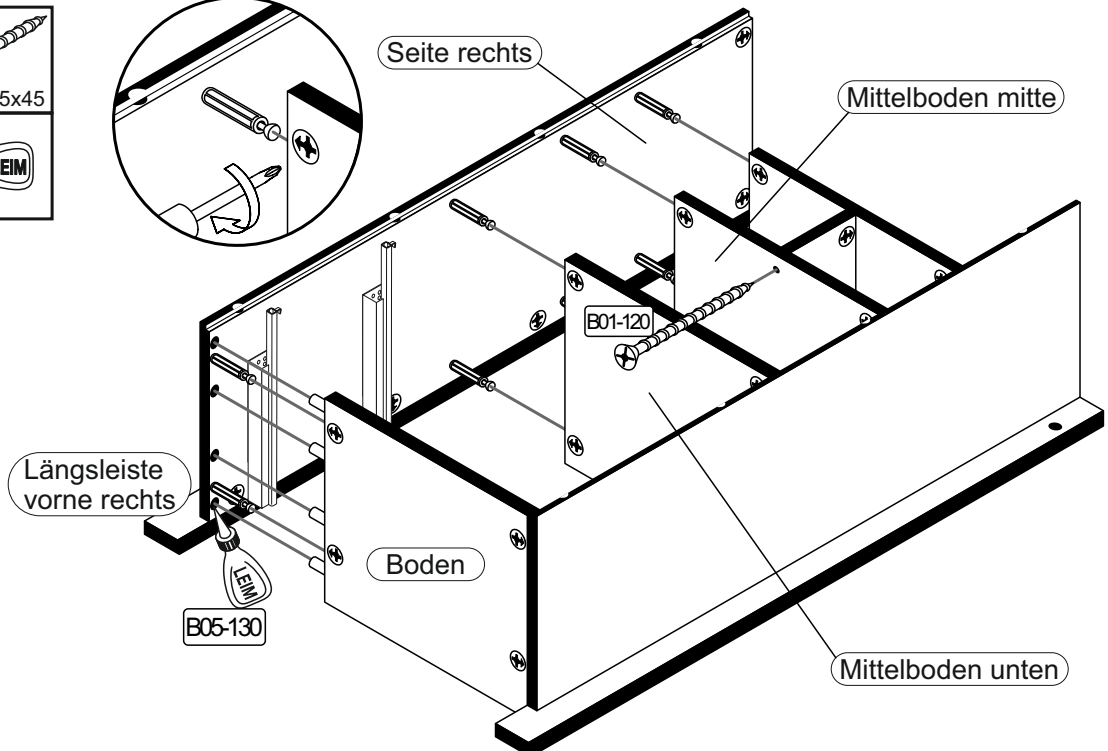
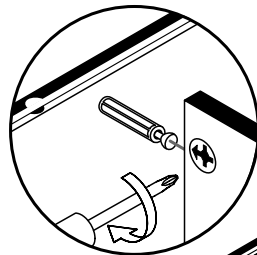

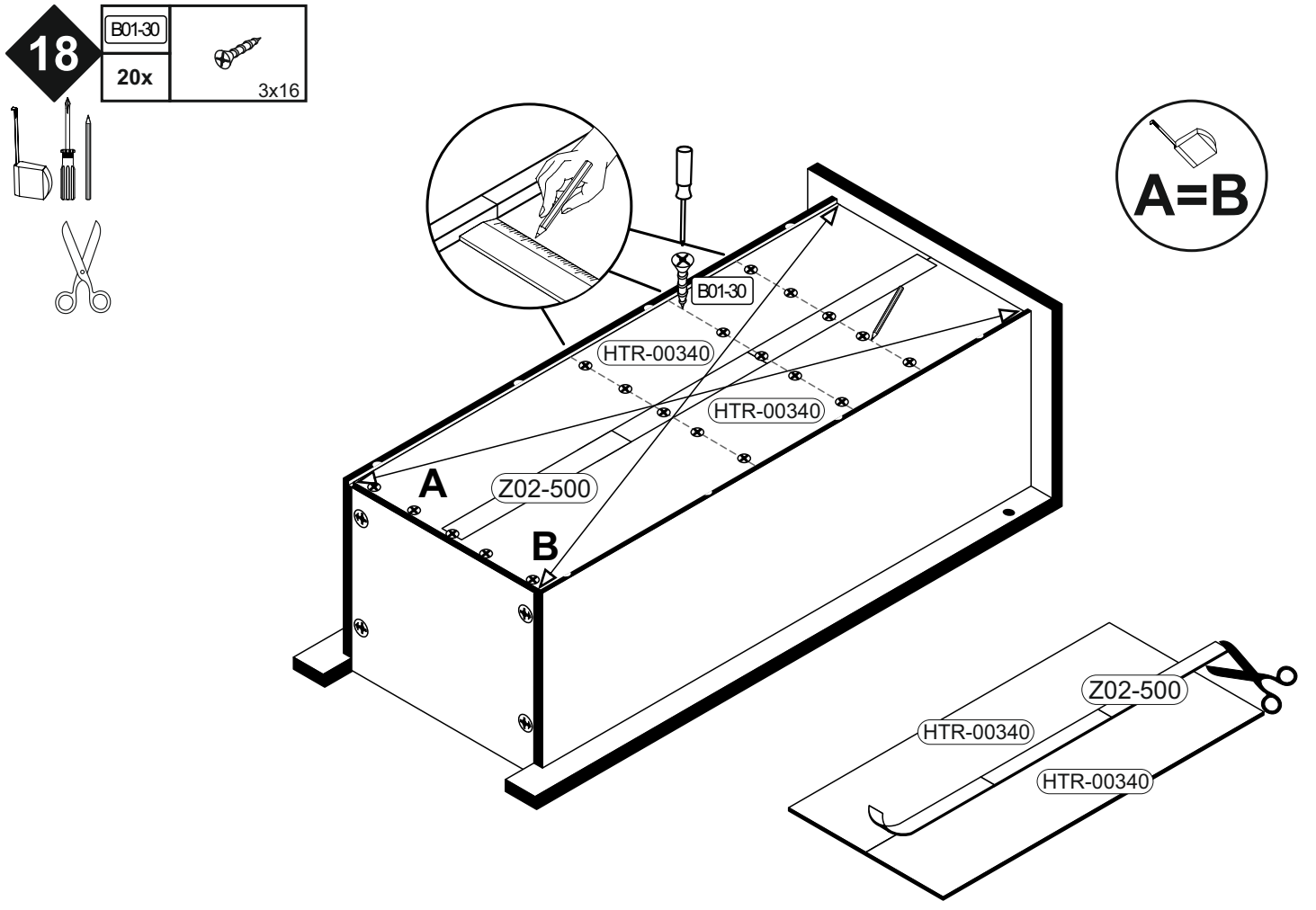
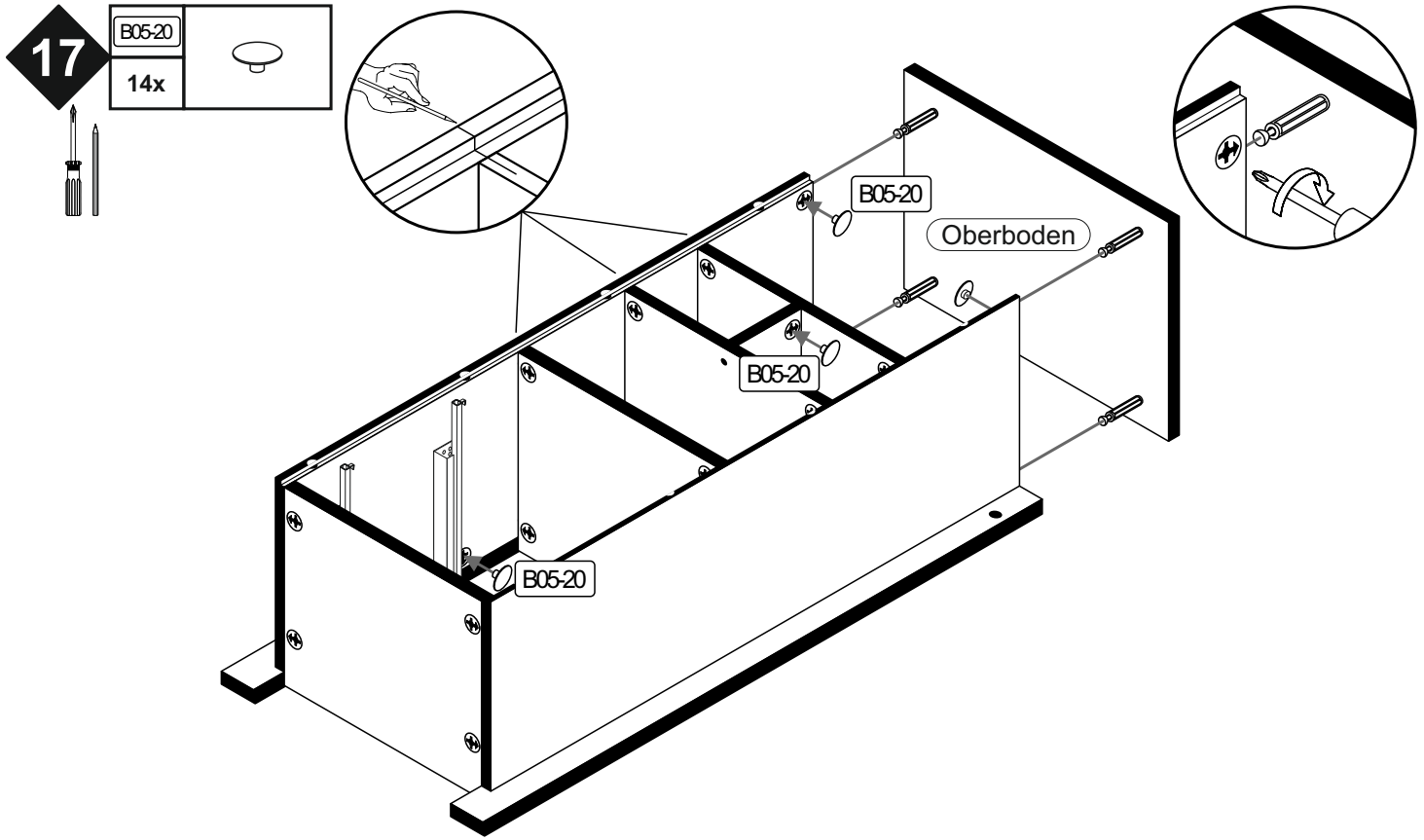

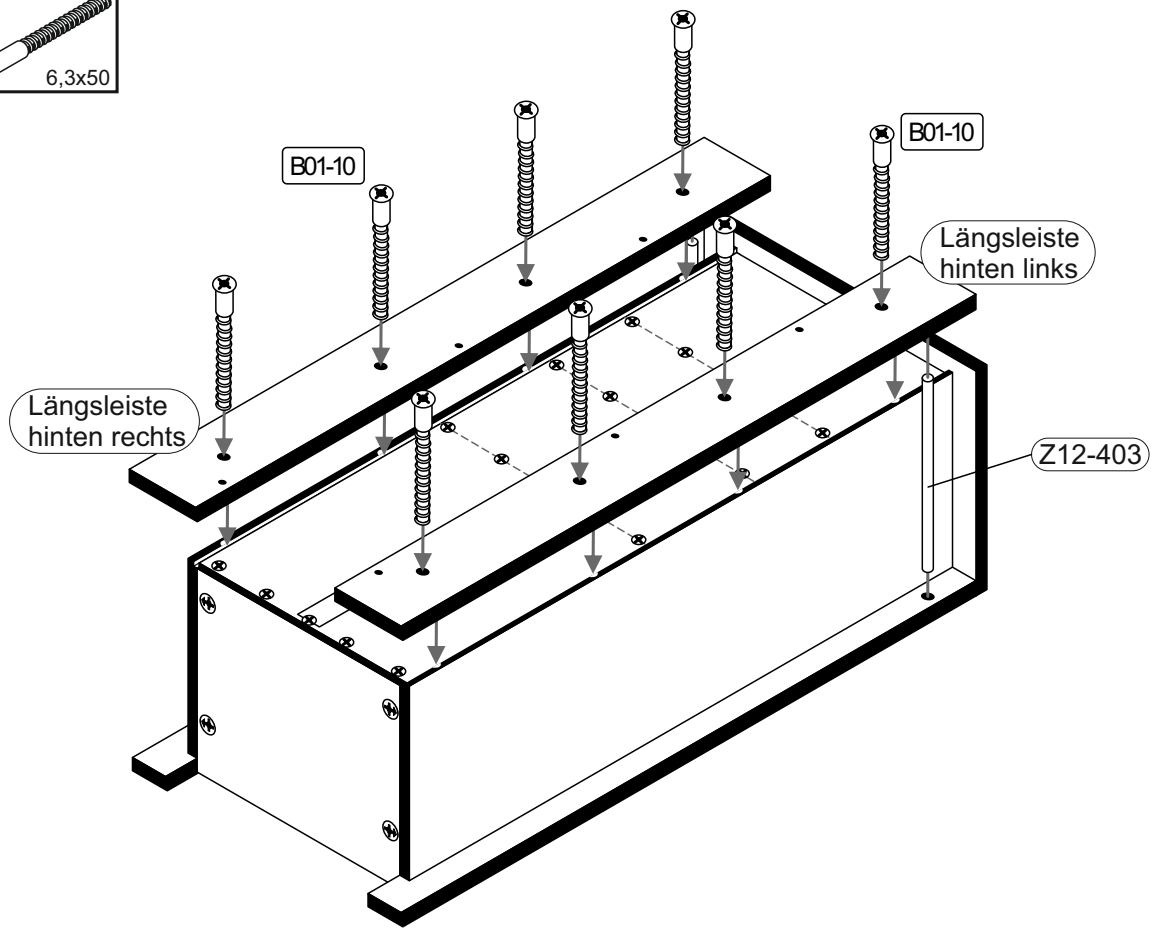

**19**

B01-10	
8x	6,3x50



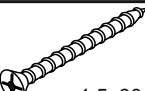

**20**

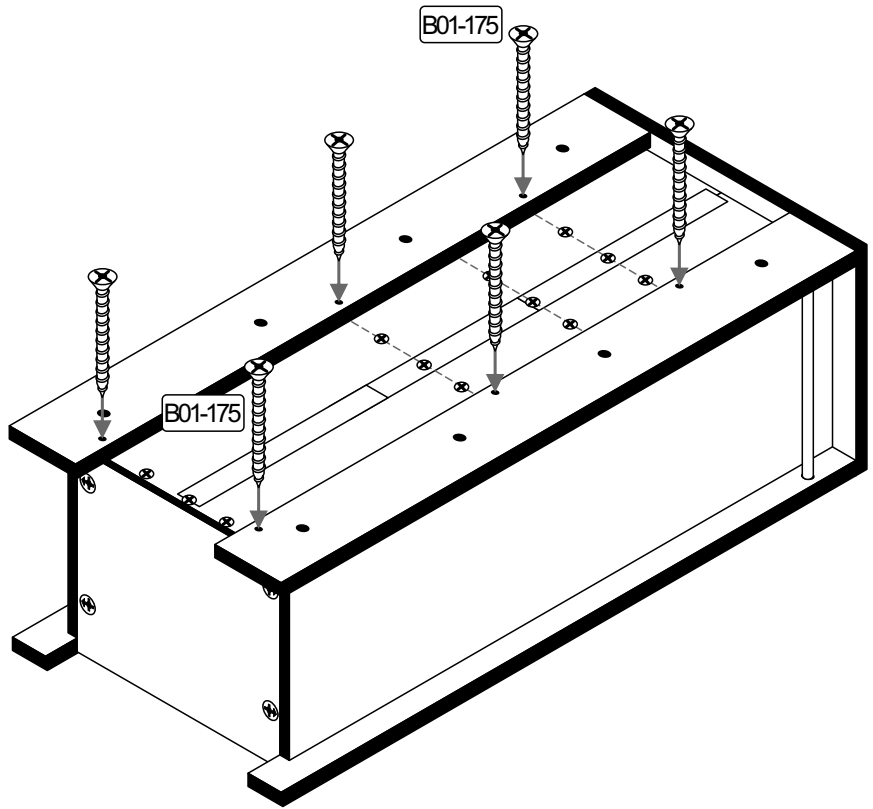
B01-175	
6x	4,5x60



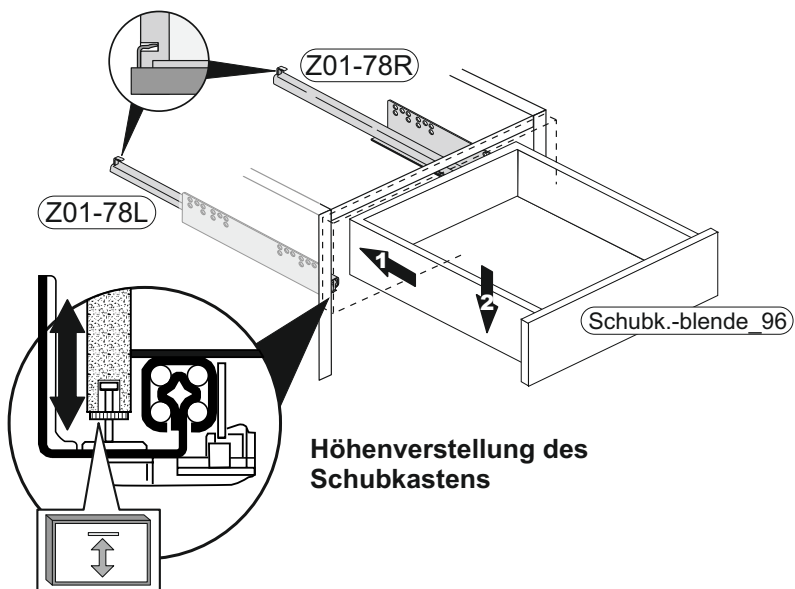
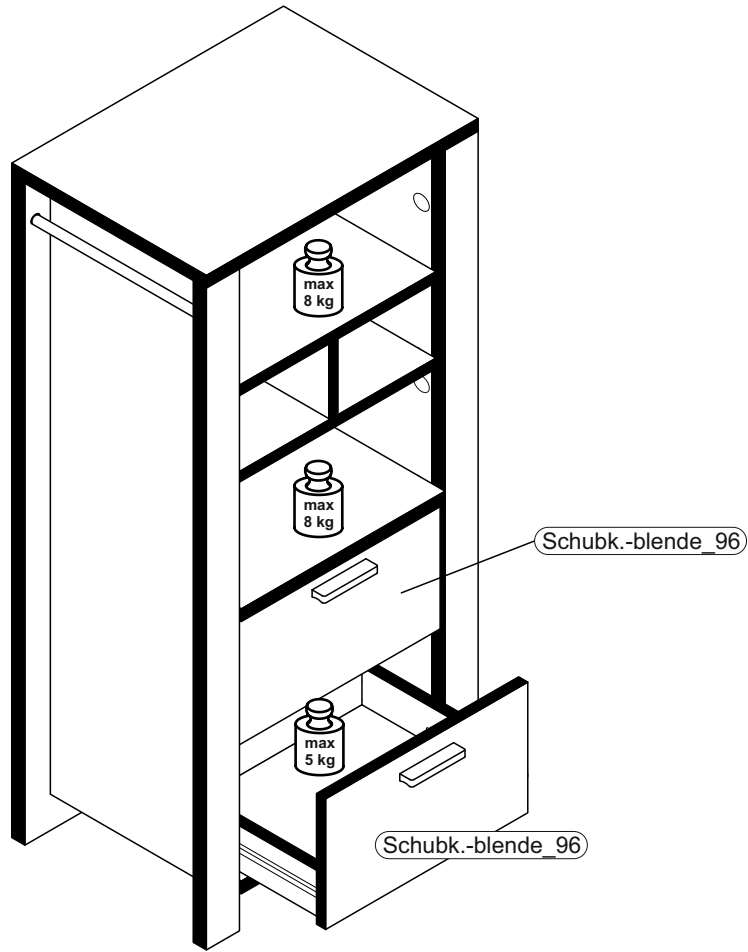

▶ SCAN ME

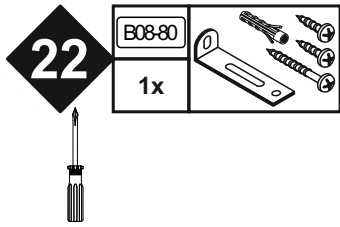

▶ SCAN ME

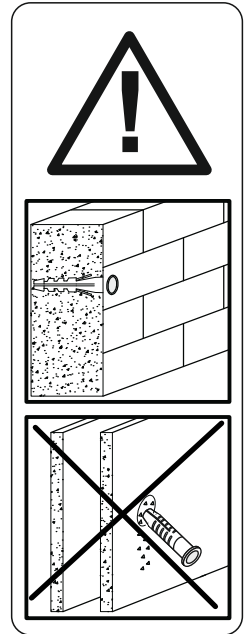
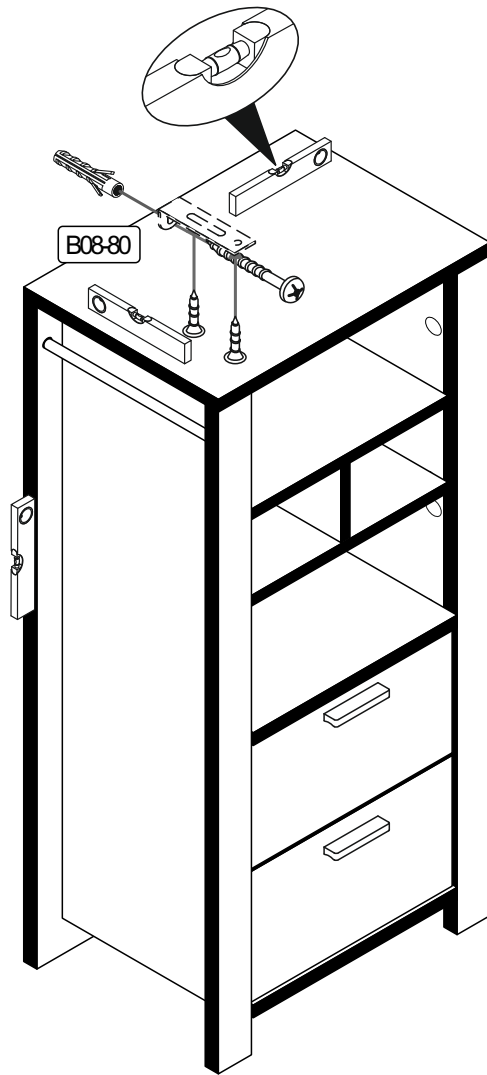

<b>Achtung • Attention • Attenzione • Opgelet • Uwaga • Pozor •            Figyelem • Atenție • Dikkat • Внимание</b>	
(D)	Wandbefestigung dient als Kippschutz - unbedingt anbringen! Bei einigen Wandtypen kann ein Spezialdübel erforderlich sein!
(GB)	The wall fastening serves to prevent tipping - be absolutely sure to mount it! For certain wall types, a special wall plug may be necessary!
(FR)	La fixation murale sert de protection contre le basculement – à installer impérativement ! Pour certains types de murs il faut des chevilles spéciales !
(TR)	Duvardaki sabitleme, devrilmeye karşı bir emniyet tedbiridir ve mutlaka monte edilmelidir! Bazı duvar tiplerinde bunun için özel bir dübel gerekli olabilir!
(IT)	Il fissaggio alla parete serve da protezione anti-ribaltamento – attaccarla assolutamente! Per alcune strutture di parete può essere necessario un tassello speciale!
(NL)	Bevestiging aan de muur dient als kantelbescherming – zeker en vast bevestigen! Bij enkele muurtypes is een speciale plug misschien vereist!
(RU)	Обязательно установите крепление на стене во избежание опрокидывания! Для некоторых типов стен может потребоваться специальный дюбель!
(CZ)	Montáž na stěnu slouží jako ochrana proti převrnutí – bezpodmínečně umístěte! U některých typů stěn může být zapotřebí speciální hmoždinka!
(HU)	A terméket a falhoz kel rögzíteni, különben az felborulhat! Egyes faltípusoknál speciális tiplit kell használni!
(RO)	Sistemul de fixare la perete servește ca protecție la răsturnare - de montat obligatoriu! Pentru unele tipuri de perți este posibil să fie necesar un diblu special!
(PL)	Mocowanie do ściany jest jednocześnie zabezpieczeniem przed przewróceniem – koniecznie zamontować! Do niektórych rodzajów ścian koniecznie zastosować specjalne kołki mocujące.
(SK)	Upevnenie na stenu slúži ako ochrana proti prevráteniu – bezpodmienečne použite! Pre niektoré druhy stien môže byť potrebná špeciálna hmoždinka!