

MELLUM
2501/8300
8100/2503

- | | | | |
|-----------|--|-----------|---|
| D | MONTAGEANLEITUNG
BEDIENUNGSANLEITUNG | GB | ASSEMBLY INSTRUCTIONS
INSTRUCTION MANUAL |
| NL | HANDLEIDING VOOR DE MONTAGE
GEBRUIKSAANWIJZING | PL | INSTRUKCJA MONTAŻU
INSTRUKCJA OBSŁUGI |
| TR | MONTAJ TALIMATI
KULLANIM KLAVUZU | RU | ИНСТРУКЦИЯ ПО МОНТАЖУ
ИНСТРУКЦИЯ ПО ЭКСПЛУАТАЦИИ |
| RO | INSTRUCȚIUNI DE INSTALARE
INSTRUCȚIUNI DE UTILIZARE | IT | ISTRUZIONI DI MONTAGGIO
MANUALE DI ISTRUZIONI |
| FR | NOTICE DE MONTAGE
MANUEL INSTRUCTIONS | SK | MONTÁŽNY NÁVOD
NÁVOD NA POUŽITIE |
| HU | KÖZGYŰLÉS UTASÍTÁSOK
KEZELÉSI UTASÍTÁS | CZ | MONTÁŽNÍ NÁVOD
NÁVOD K POUŽITÍ |
| SI | NAVODILA ZA MONTAŽO
NAVODILA ZA UPORABO | PT | INSTRUÇÕES DE MONTAGEM
MANUAL DO USUÁRIO |
| ES | INSTRUCCIONES DE MONTAJE
MANUAL DEL USUARIO | HR | UPUTE ZA MONTAŽU
UPUTE ZA UPOTREBU |

F/B

220701

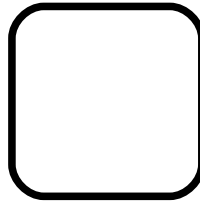
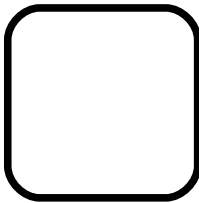

0019

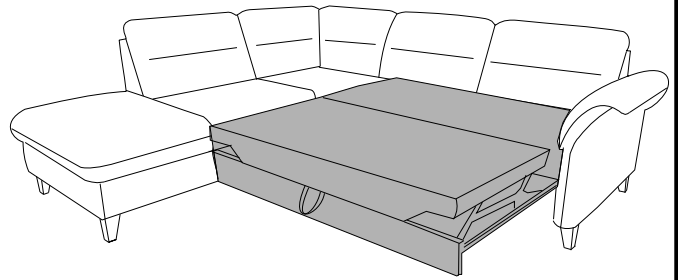
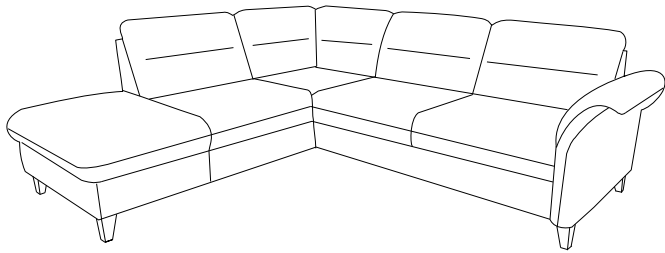

0019

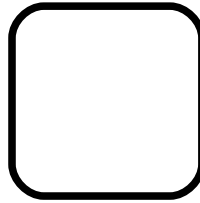
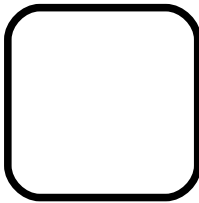

0088

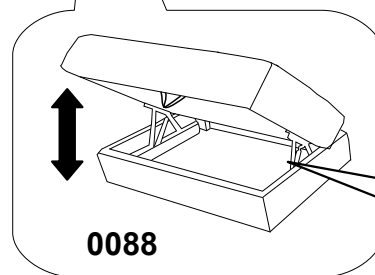
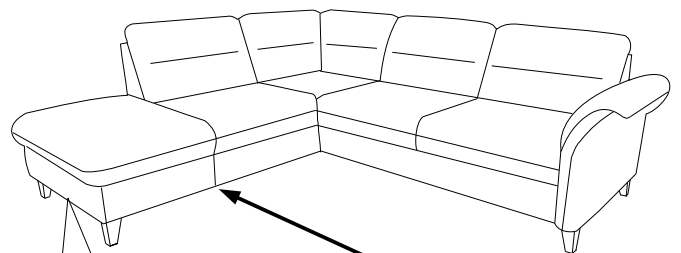
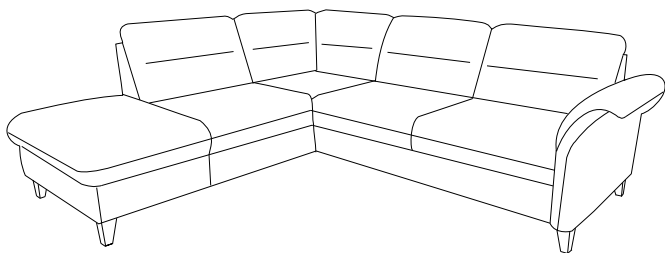
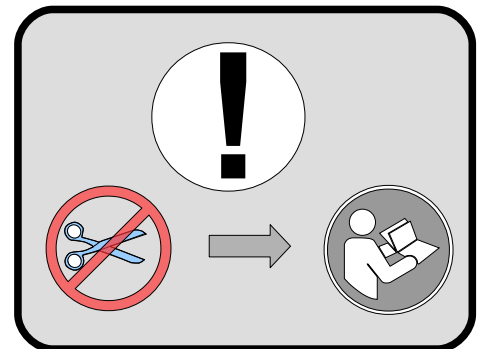

0088

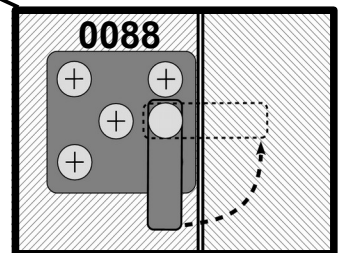

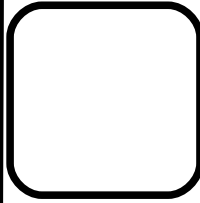
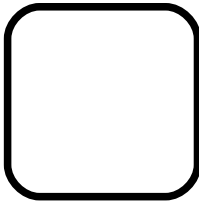

0090

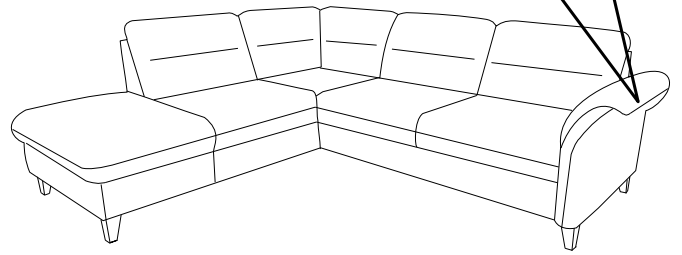
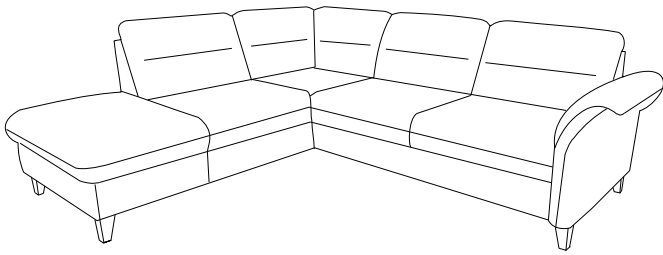
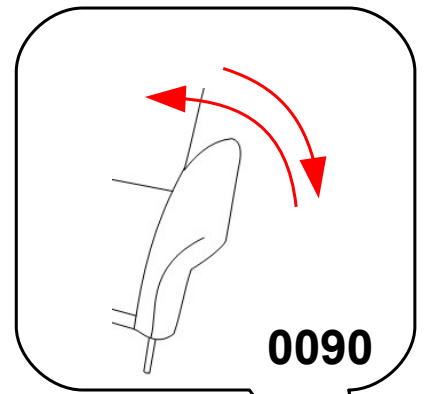



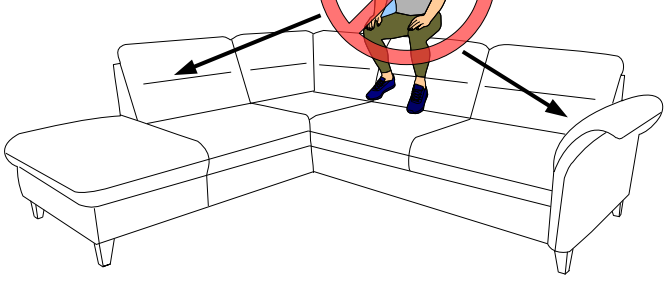

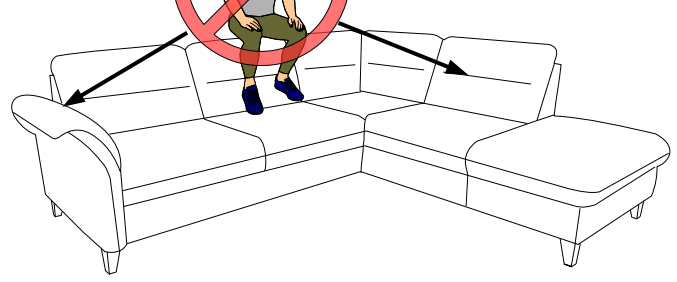

L







R

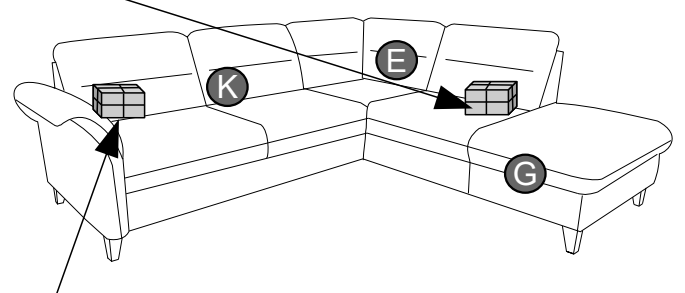
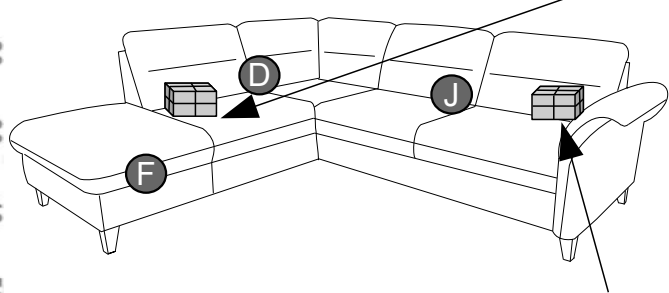

f H- 120 	Z H-120 	V Fi- 35 	X H- 120 	q M8*110 	i L- 5 	[mm]
X1	X3	X3	X3	X3	X1	





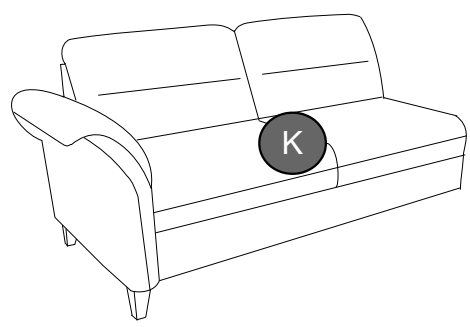
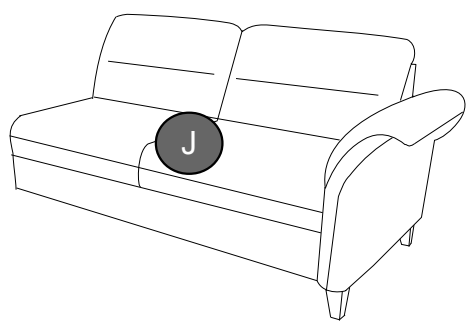
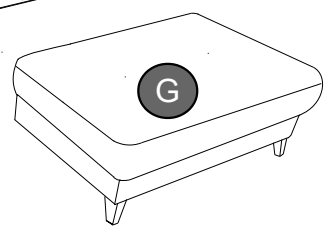
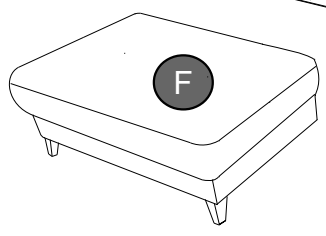
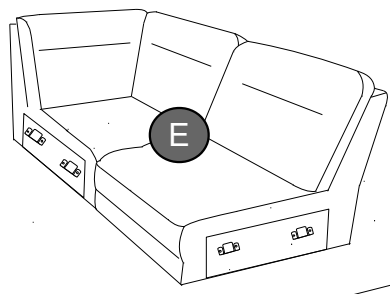
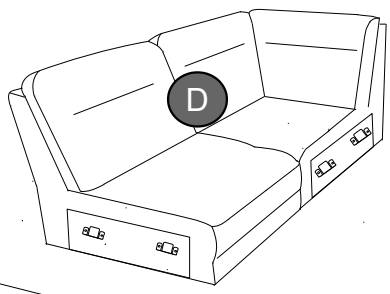

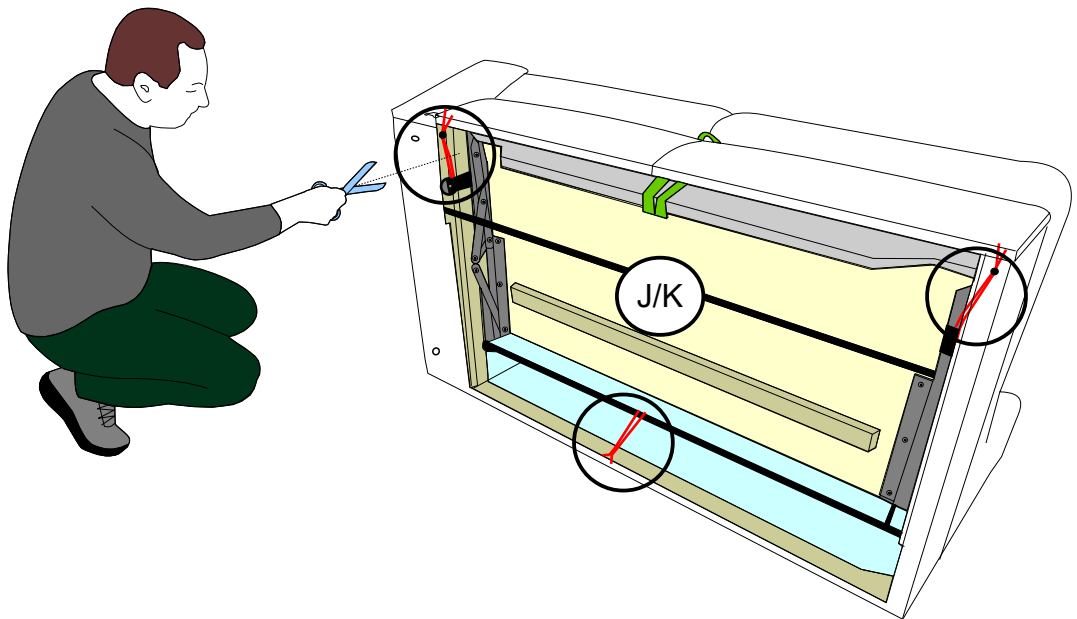
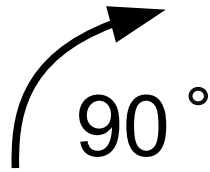
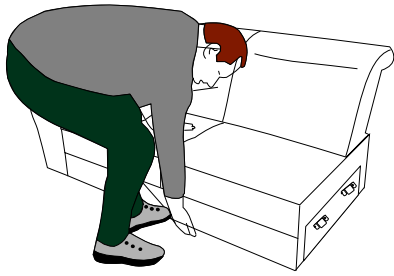

V Fi- 35 	X H- 120 	q M8*110 	i L- 5 
X2	X2	X2	X1





0019

y H-120 	Z H-120 	V Fi-35 	X H-120 	q M8*110 	i L-5 
X1	X3	X5	X5	X3	X1

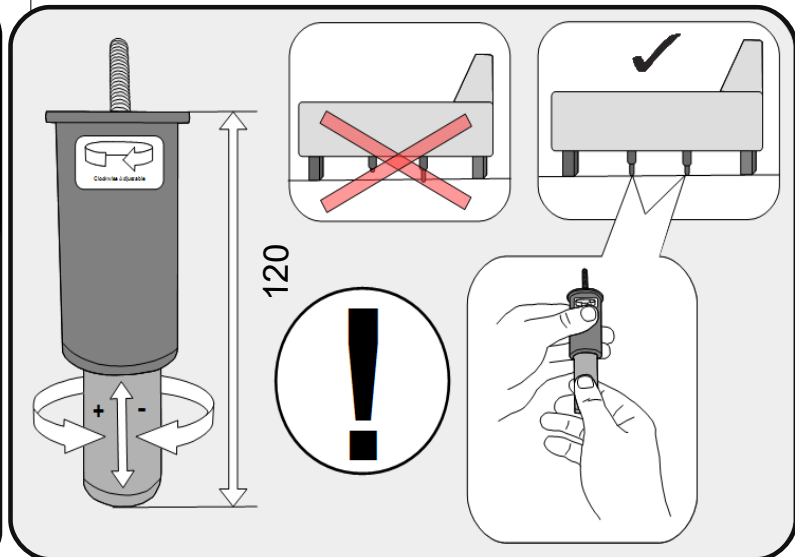
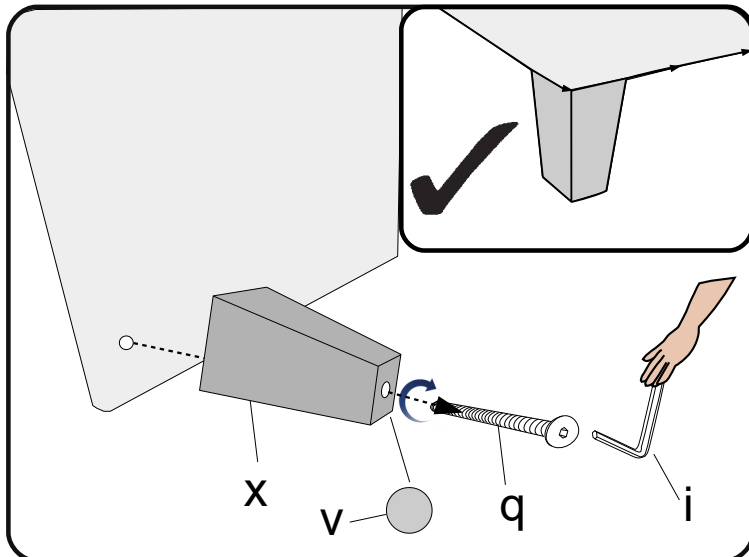
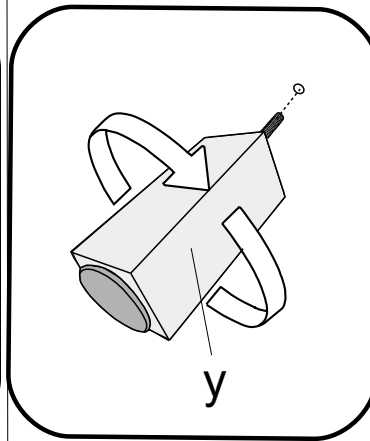
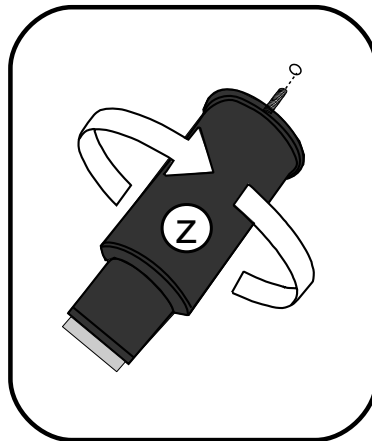
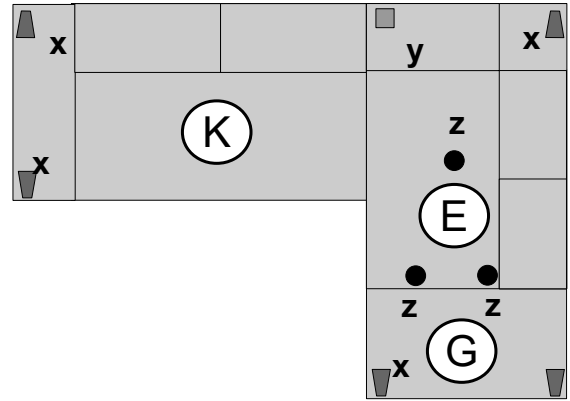
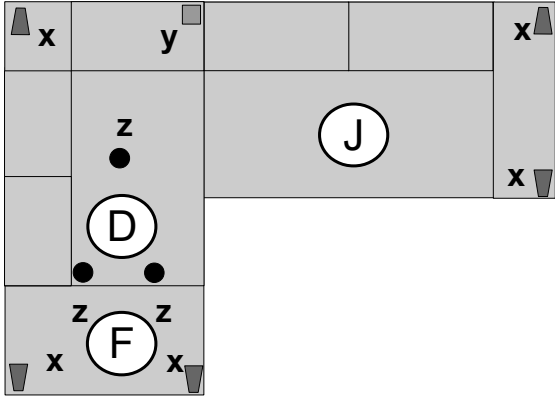
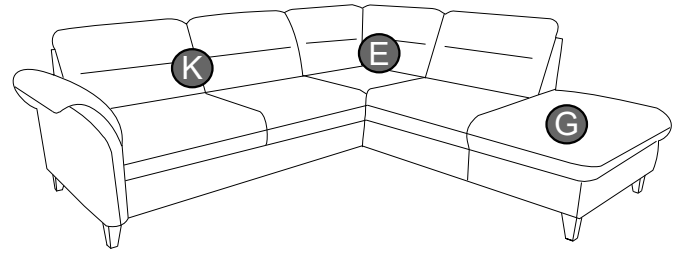
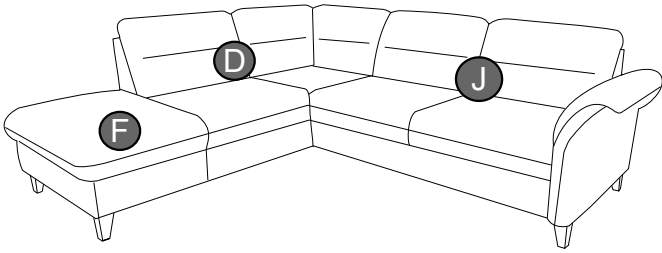

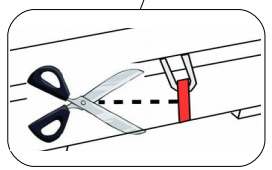
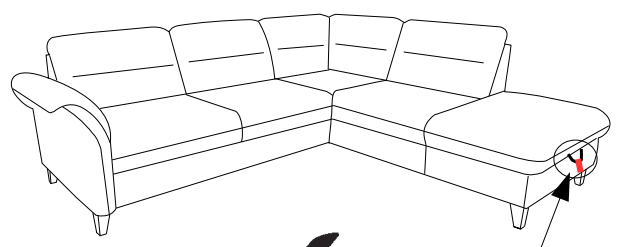
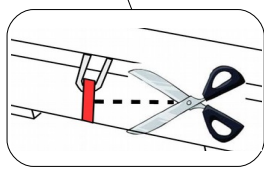
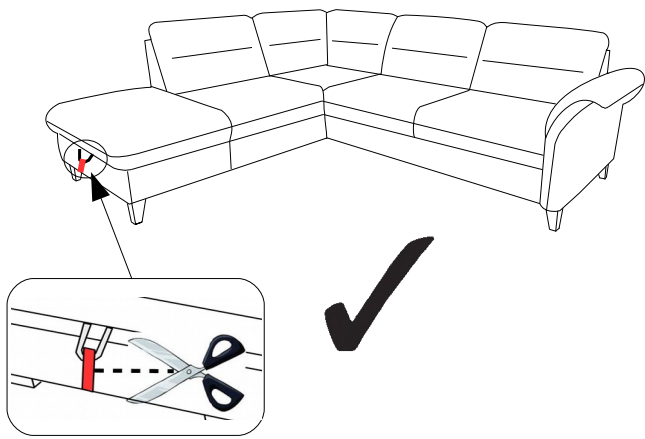
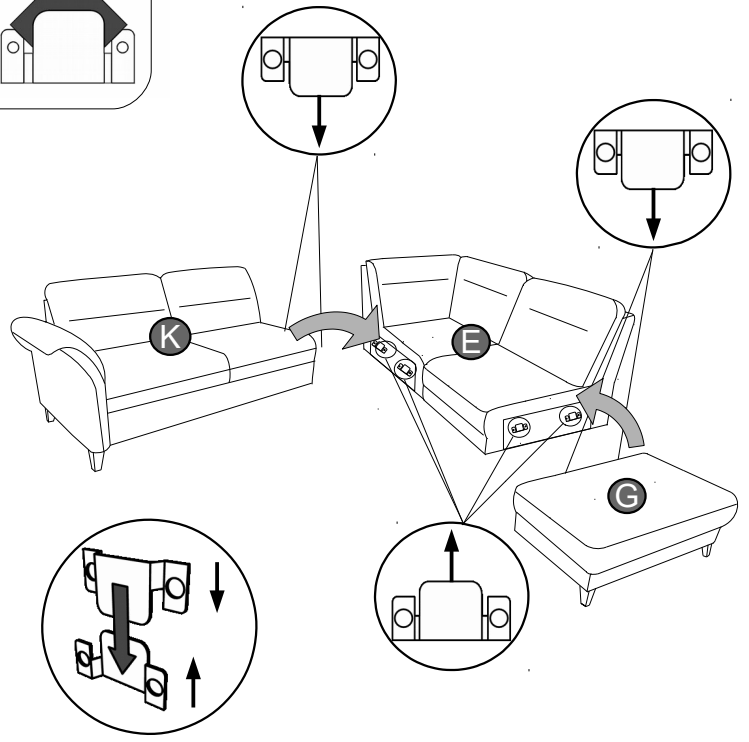
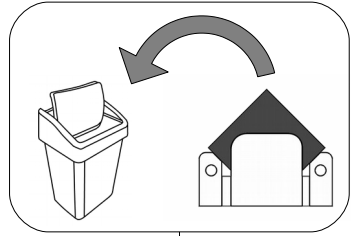
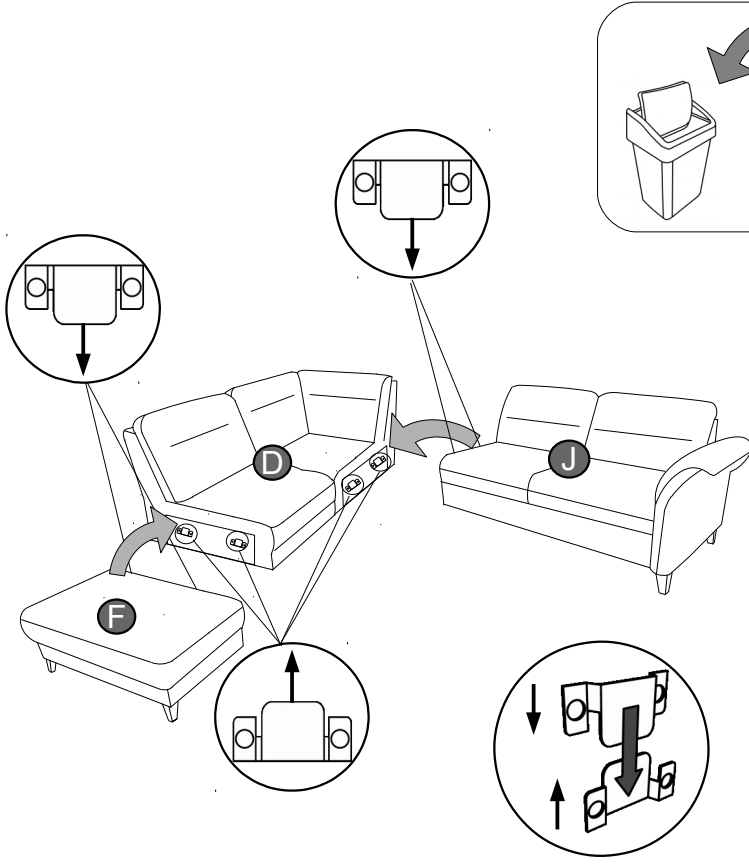

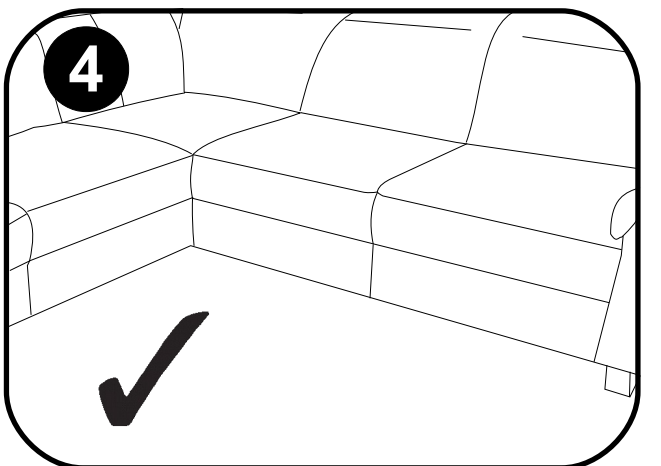
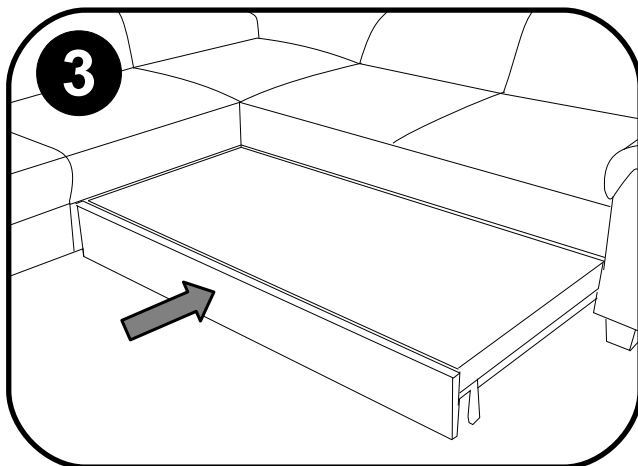
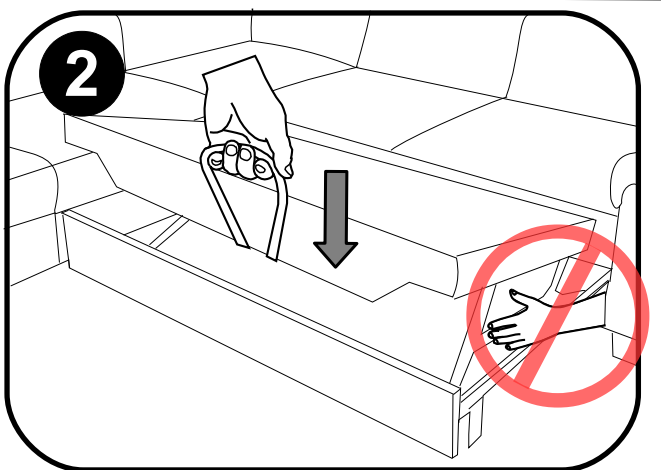
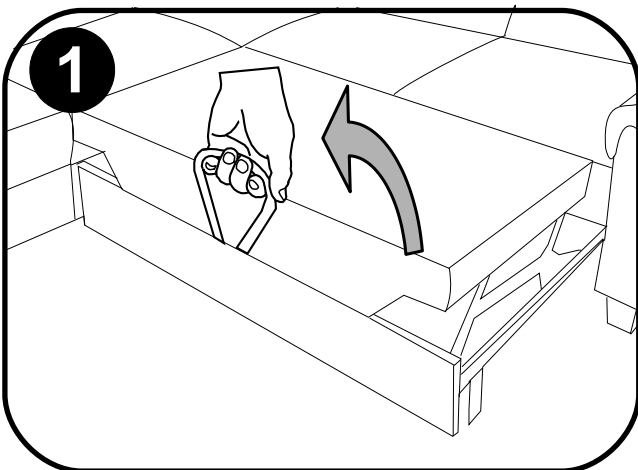
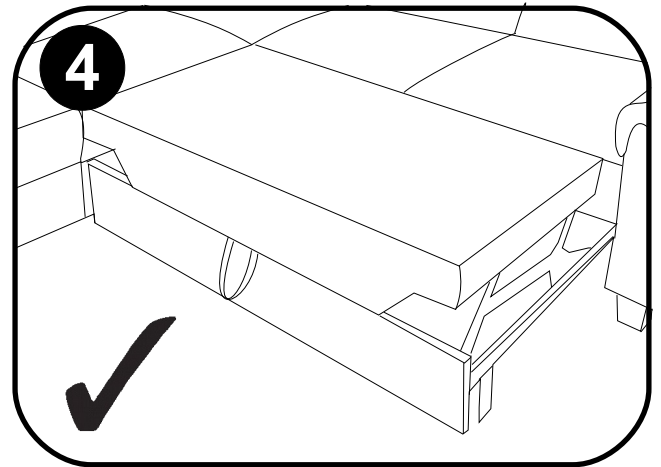
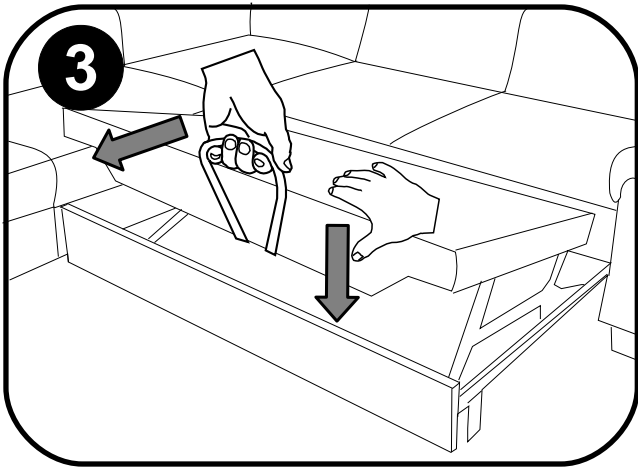
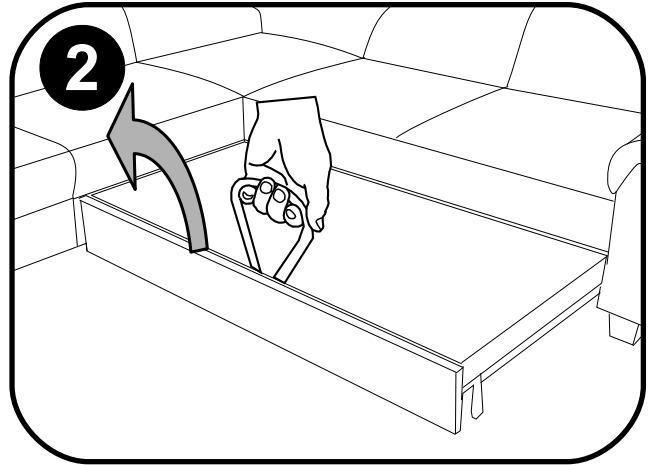
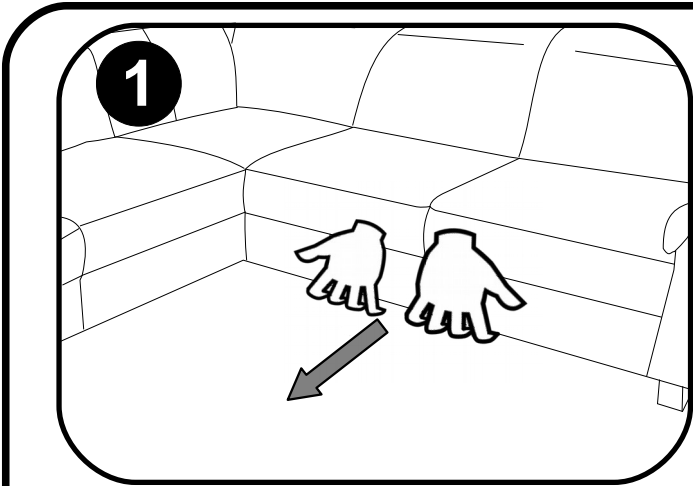
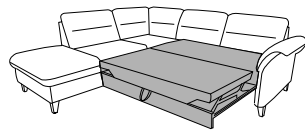
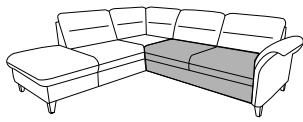

Name · Naam · Nazwa · İsim · Название · Nume · Nome · Názov · Názov ·
 Název · Neve

MELLUM

Typ · Type · Tip · Тип · Tipo · Típus

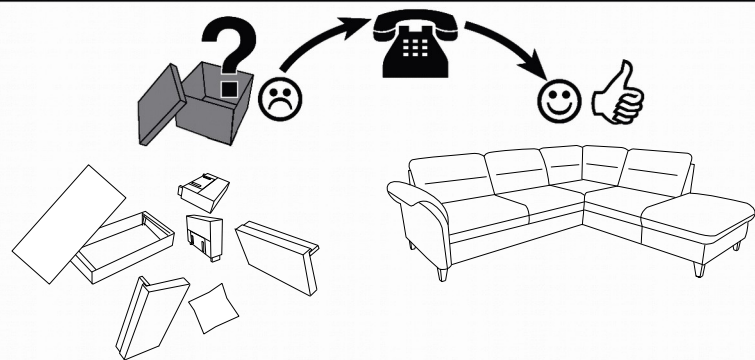
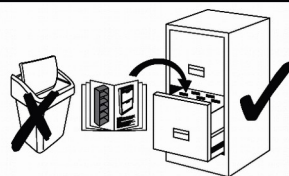

L

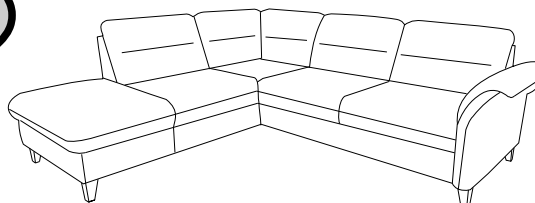

R

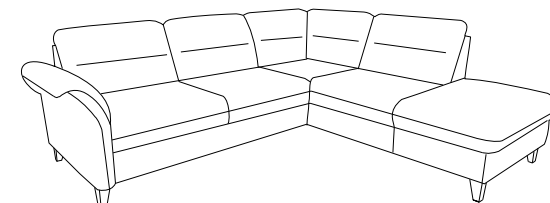

f H-120 	Z H-120 	V Fi-35 	X H-120 	q M8*110 [mm]
--------------------	--------------------	--------------------	--------------------	--------------------------

