

DANGAST

2023-01/03

D MONTAGEANLEITUNG
BEDIENUNGSANLEITUNG

NL HANDLEIDING VOOR DE MONTAGE
GEBRUIKSAANWIJZING

TR MONTAJ TALIMATI
KULLANIM KLAVUZU

RO INSTRUCȚIUNI DE INSTALARE
INSTRUCȚIUNI DE UTILIZARE

FR NOTICE DE MONTAGE
MANUEL INSTRUCTIONS

HU KÖZGYŰLÉS UTASÍTÁSOK
KEZELÉSI UTASÍTÁS

SI NAVODILA ZA MONTAŽO
NAVODILA ZA UPORABO

ES INSTRUCCIONES DE MONTAJE
MANUAL DEL USUARIO

GB ASSEMBLY INSTRUCTIONS
INSTRUCTION MANUAL

PL INSTRUKCJA MONTAŻU
INSTRUKCJA OBSŁUGI

RU ИНСТРУКЦИЯ ПО МОНТАЖУ
ИНСТРУКЦИЯ ПО ЭКСПЛУАТАЦИИ

IT ISTRUZIONI DI MONTAGGIO
MANUALE DI ISTRUZIONI

SK MONTÁŽNY NÁVOD
NÁVOD NA POUŽITIE

CZ MONTÁŽNÍ NÁVOD
NÁVOD K POUŽITÍ

PT INSTRUÇÕES DE MONTAGEM
MANUAL DO USUÁRIO

HR UPUTE ZA MONTAŽU
UPUTE ZA UPOTREBU





Service · Dienstverlening · Serwis · Servis · Сервисная служба · Serviciu · Services · Servizio
 ·Servisný list · Szolgáltatás · Servisní list

Name · Naam · Nazwa · Ísim · Название · Nume · Nome · Názov · Názov ·
 Název · Neve

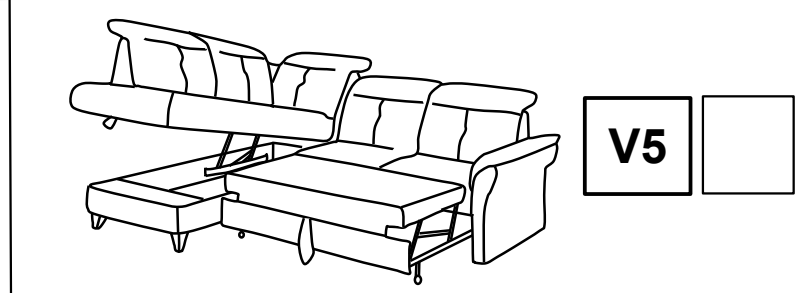
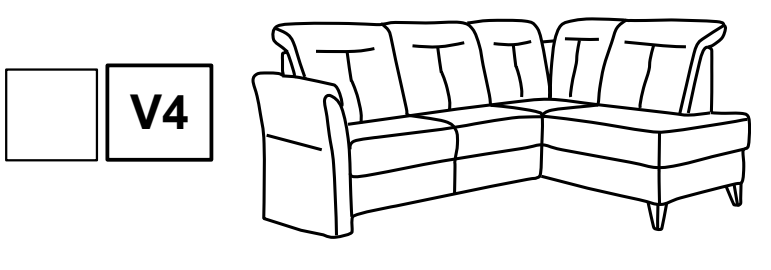
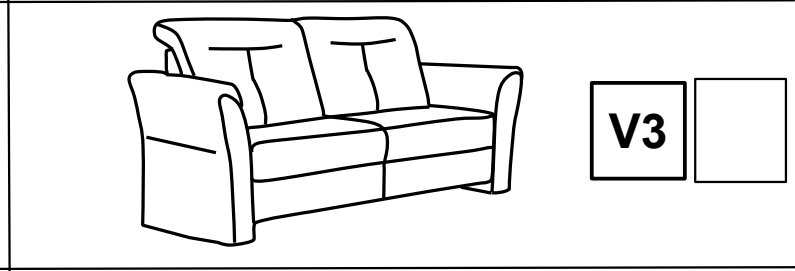
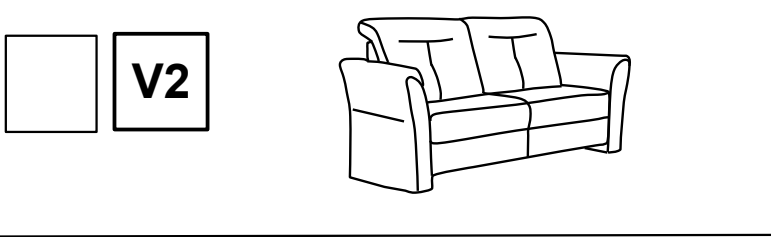
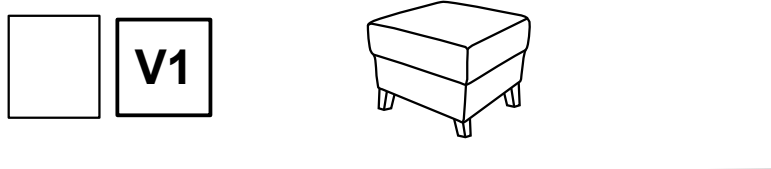
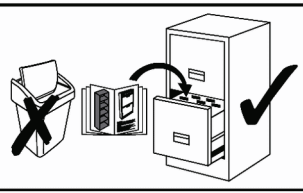
DANGAST

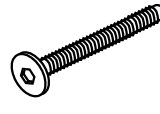
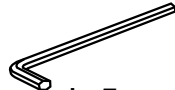
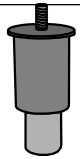
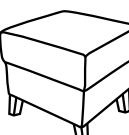
Typ · Type · Tip · Тип · Tipo · Típus

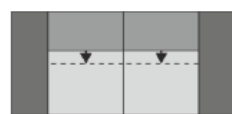

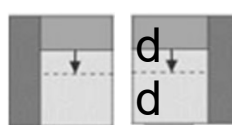





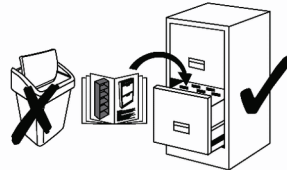

<input checked="" type="checkbox"/>			a	b	c	d
			 a1	 M8x110mm	 L-5	 110-190
	 V1		4x	4x	1x	2x
	 V2		/	/	/	/
	 V3		/	/	/	2x

Name · Naam · Nazwa · Ísim · Название · Nume · Nome · Názov · Názov ·
 Název · Neve

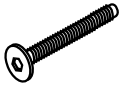
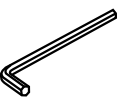
DANGAST

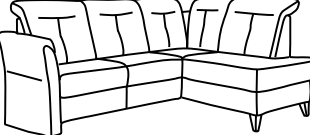
Typ · Type · Tip · Тип · Tipo · Típus

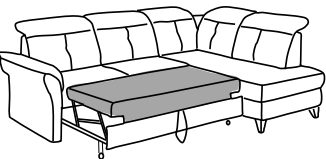

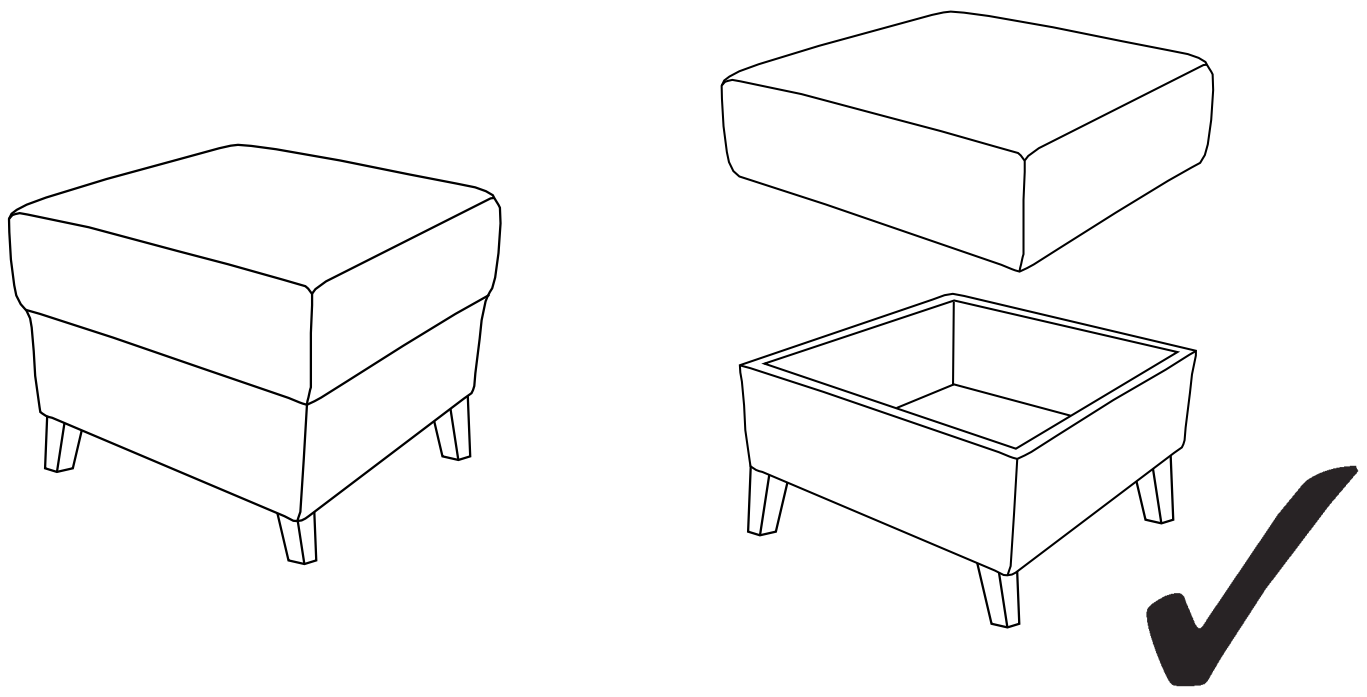
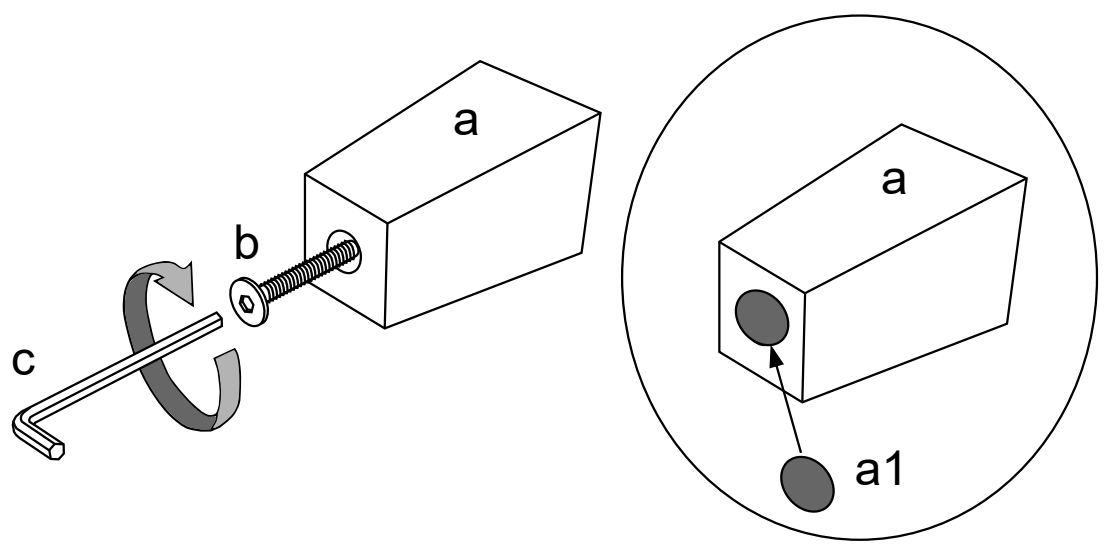
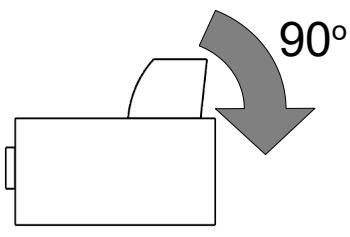
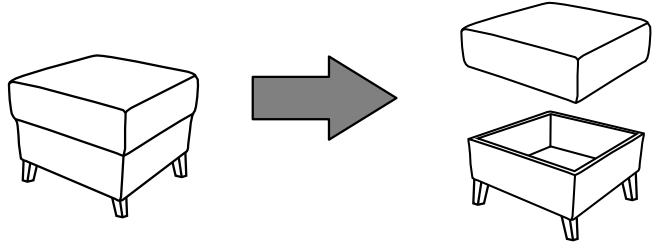

		a	b	c	d
		 a1	 M8x110mm	 L-5	 110mm - 190mm
10	V4 	/	/	/	2x
8		4x	4x	1x	2x
6	V5 	/	/	/	/
4		4x	4x	1x	2x

V1

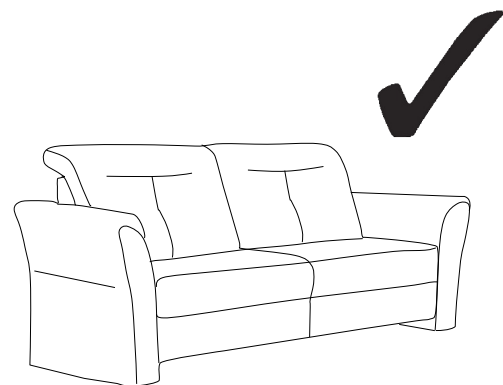
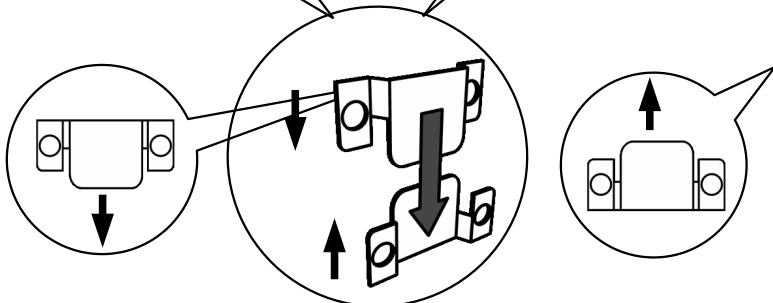
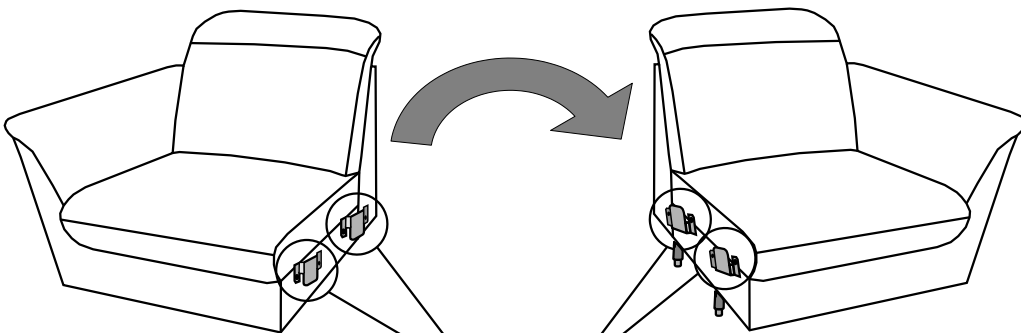
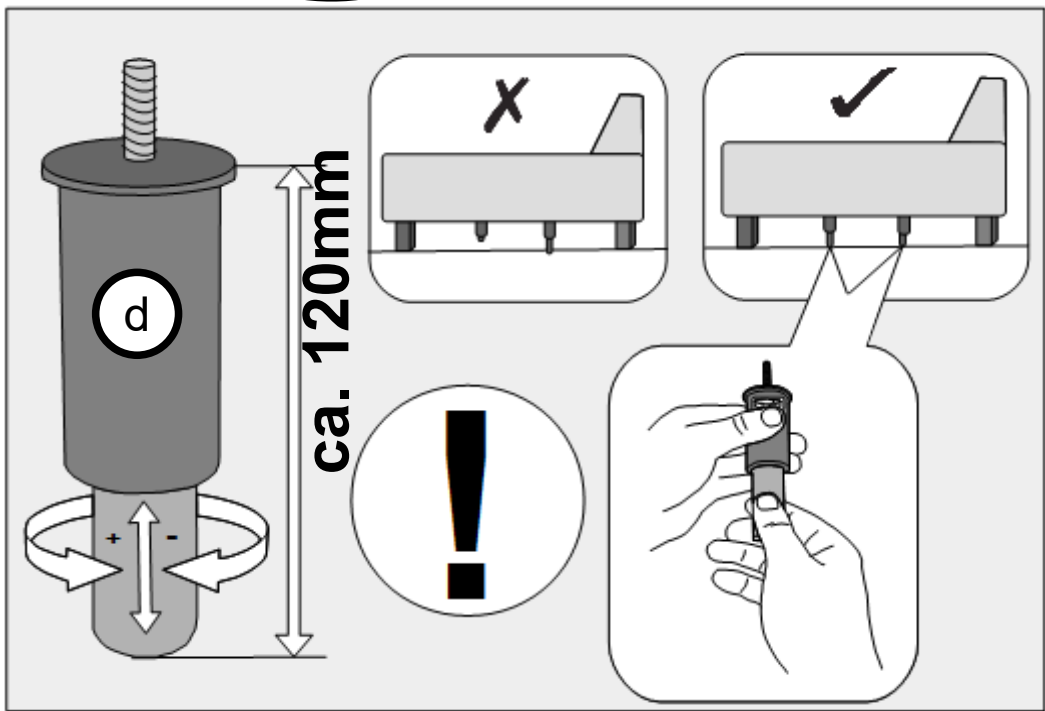
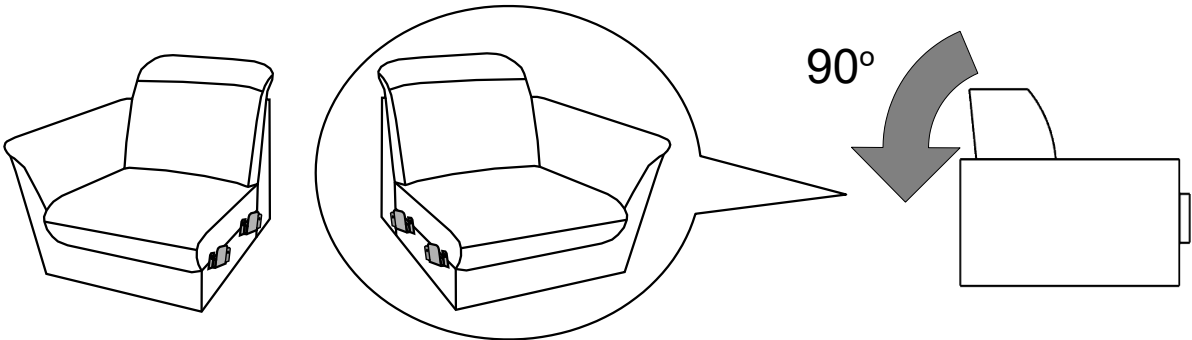
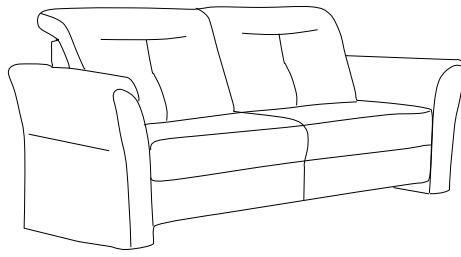

V3



V4

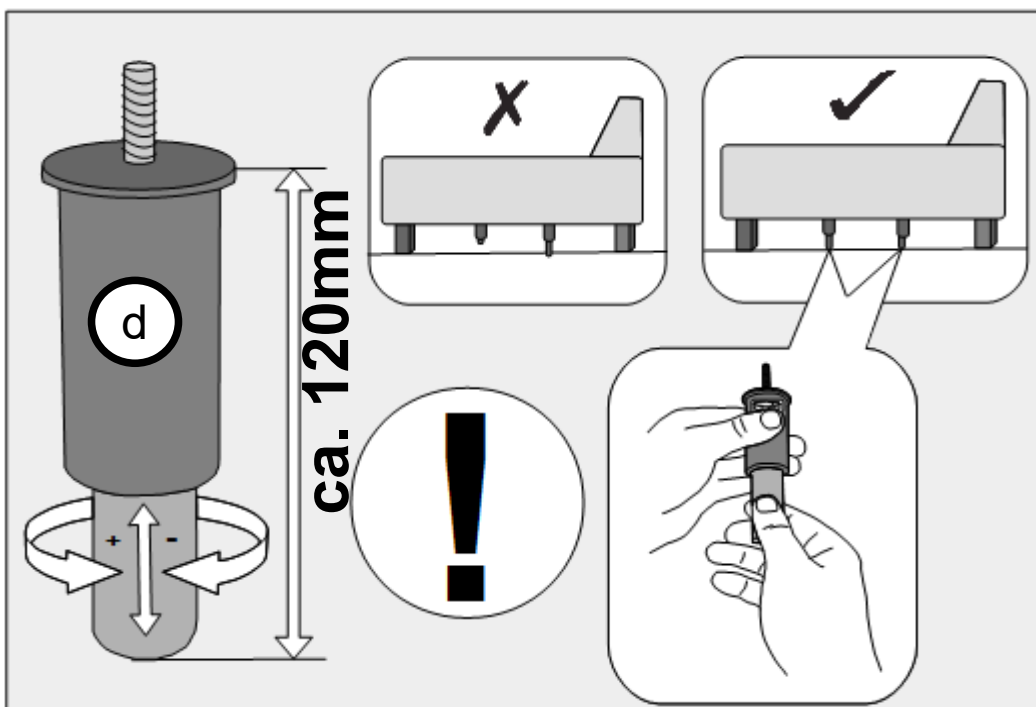
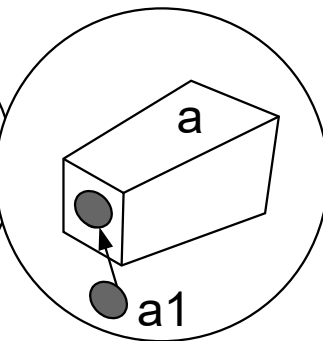
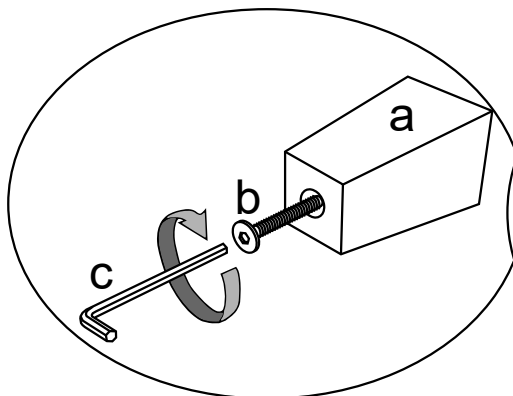
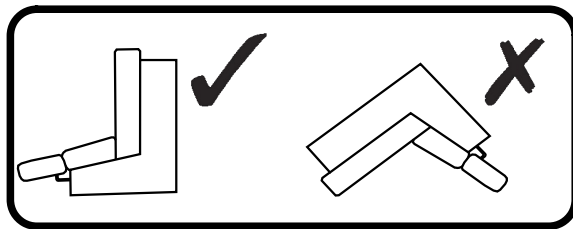
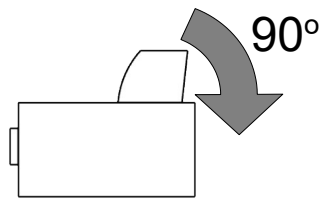
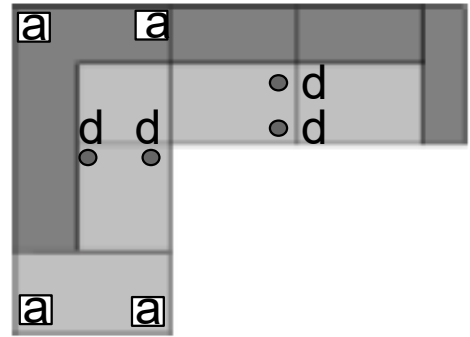
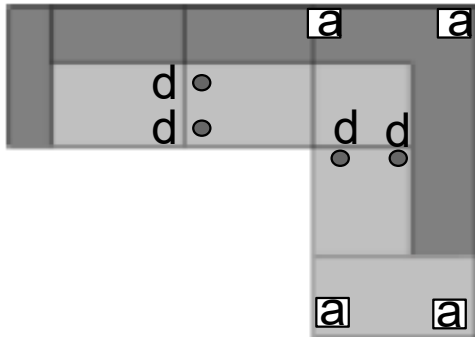
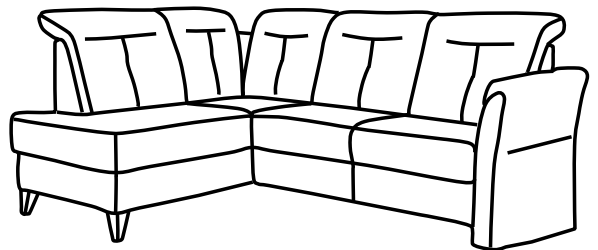
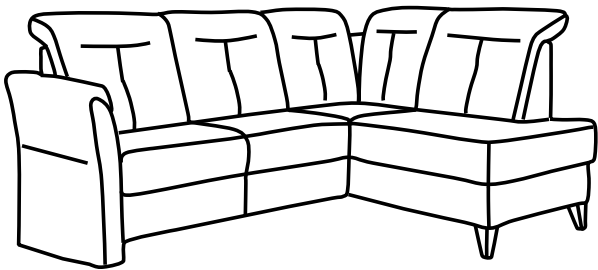

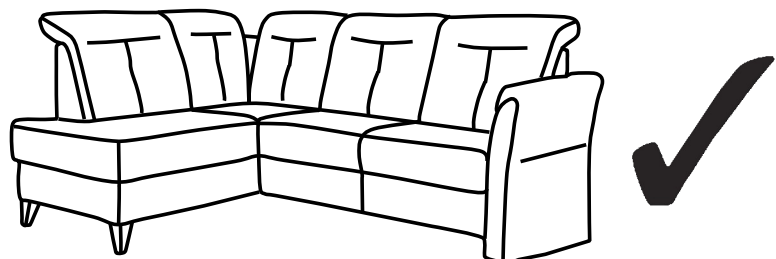
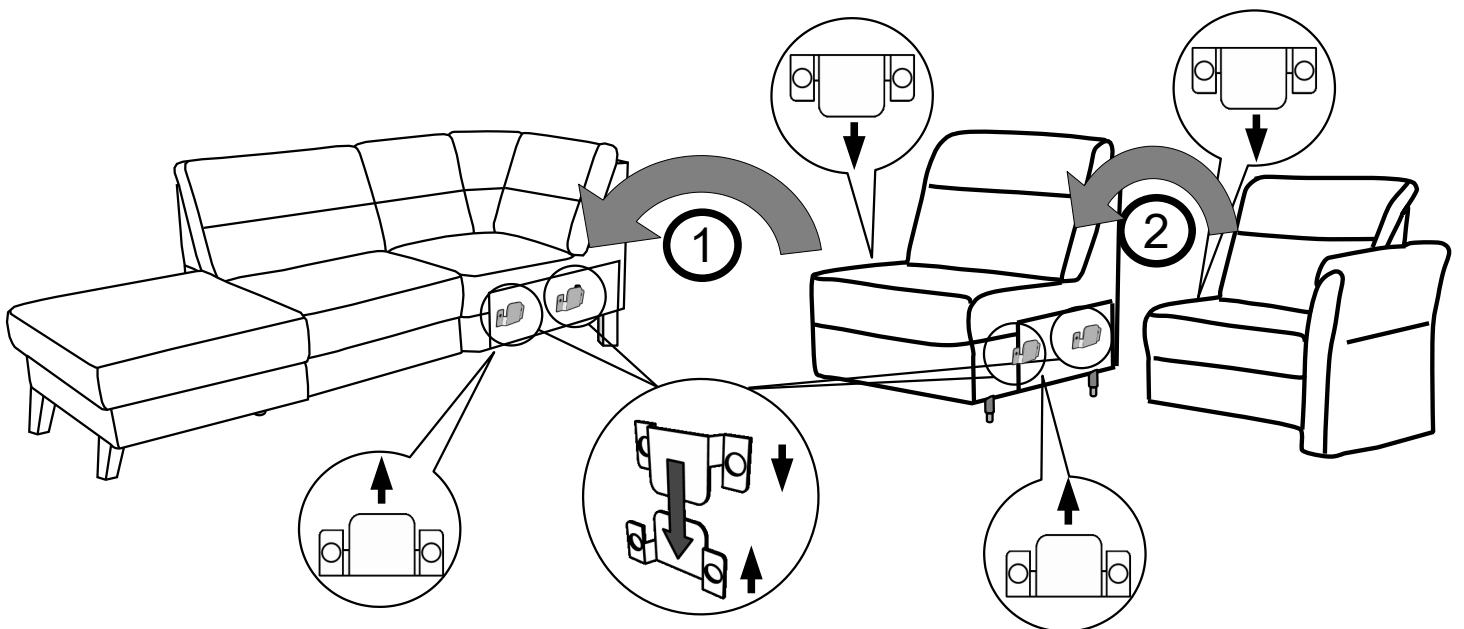
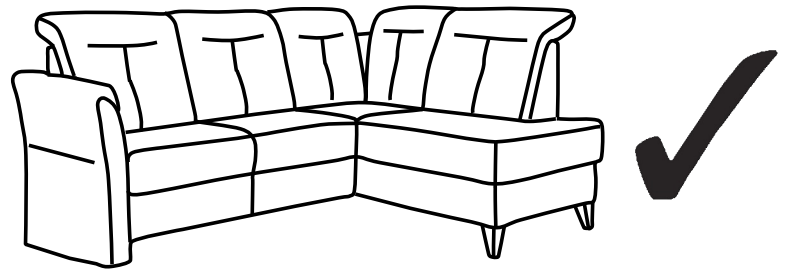
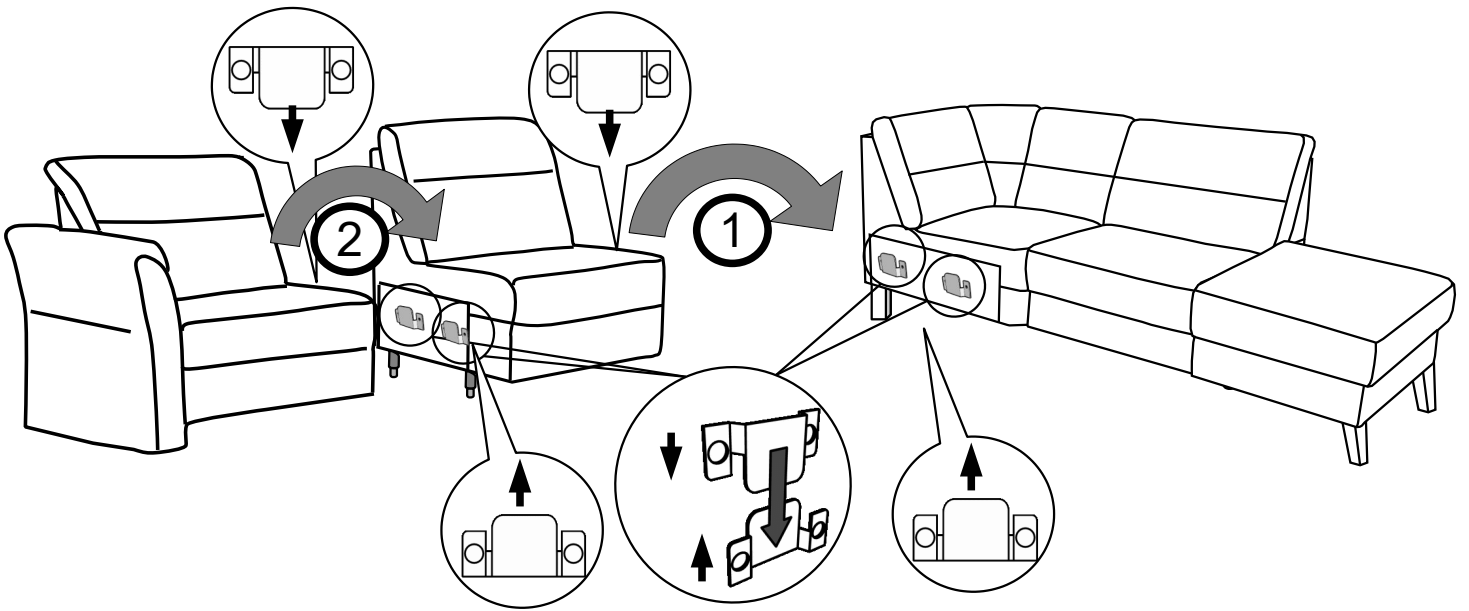

V5

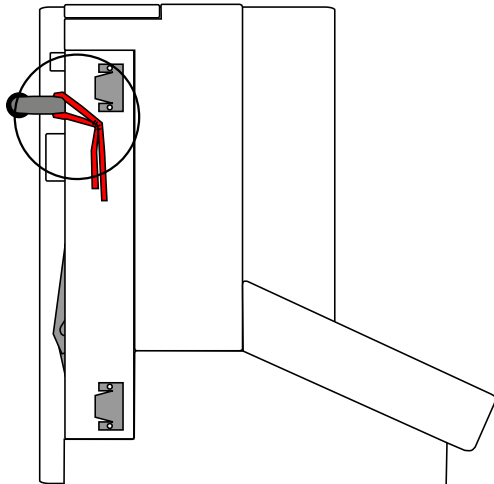
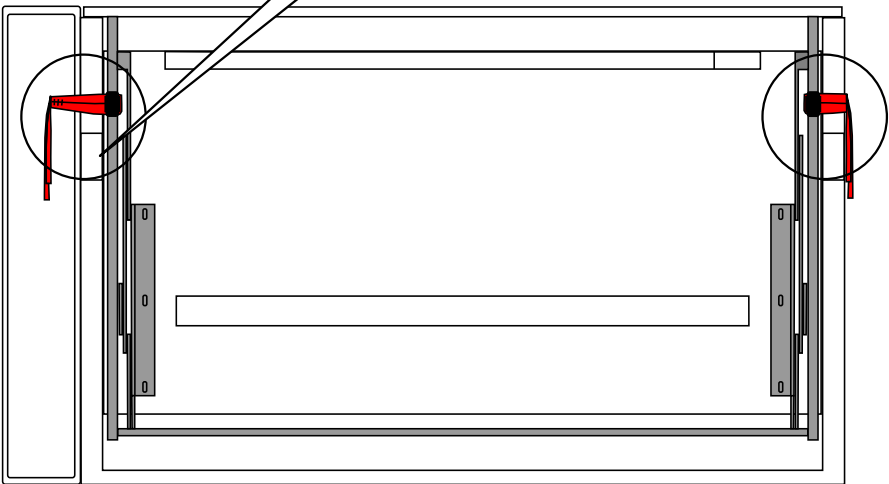
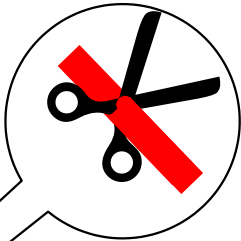
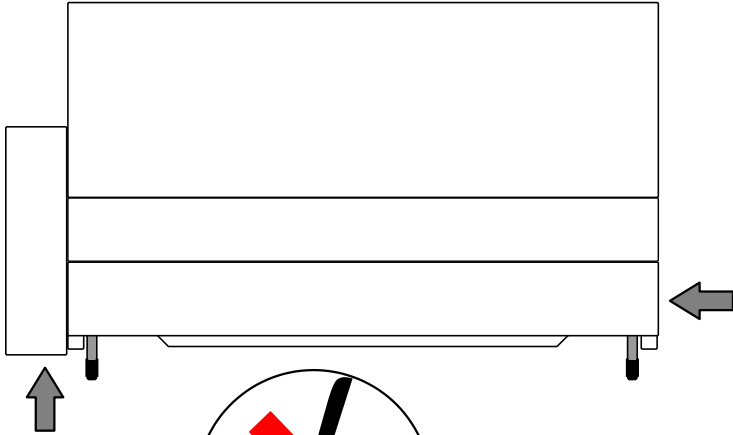
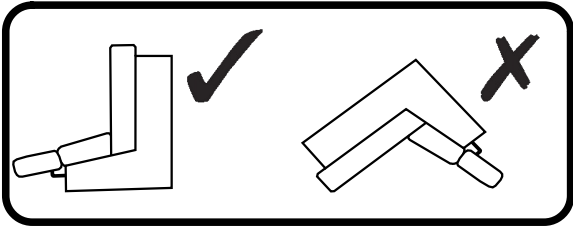
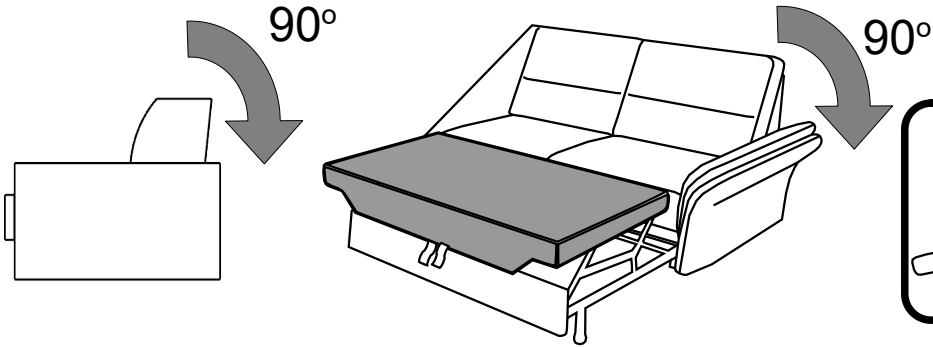
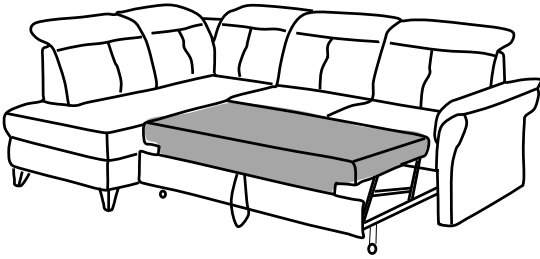
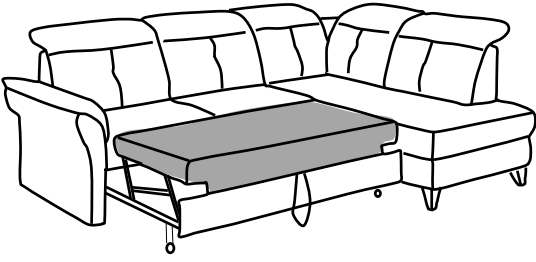

90°

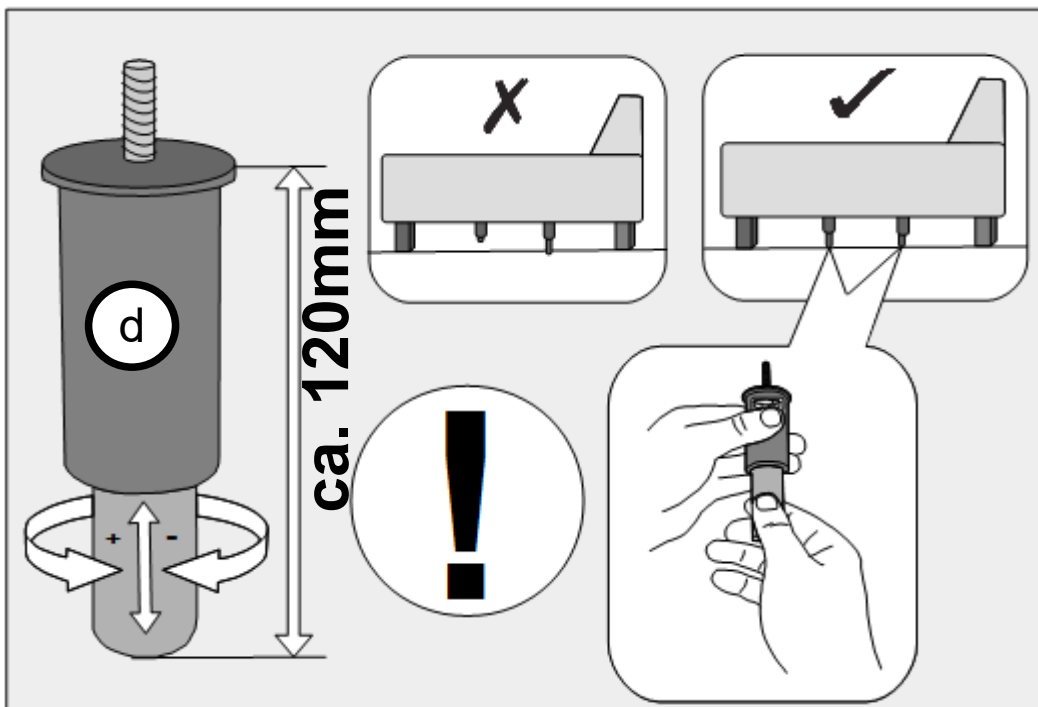
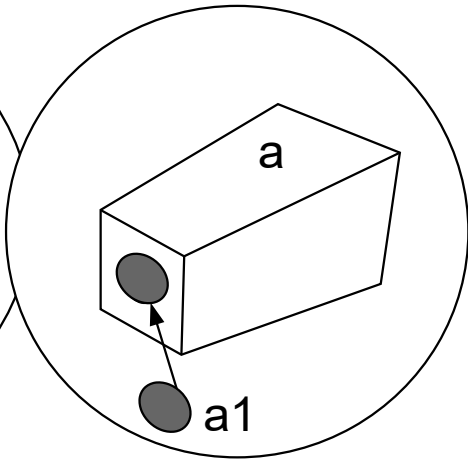
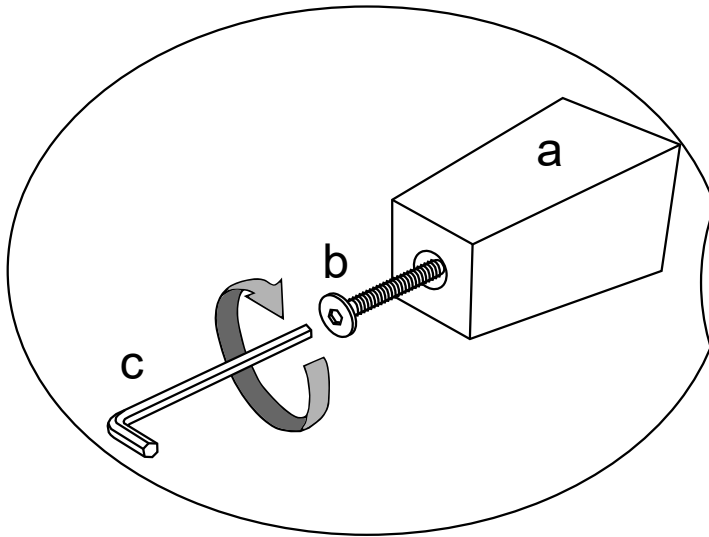
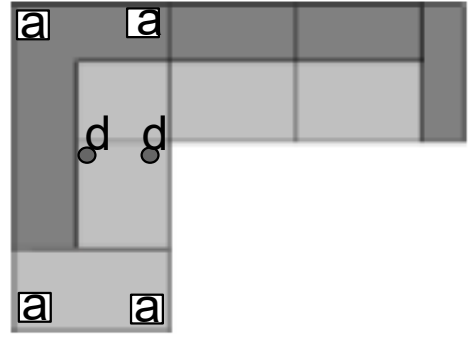
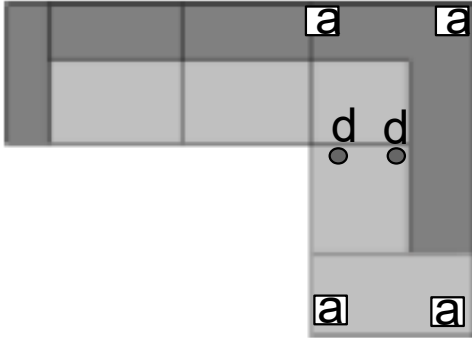
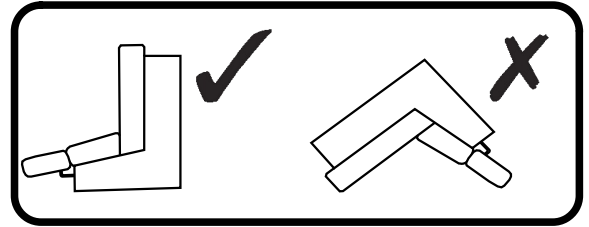
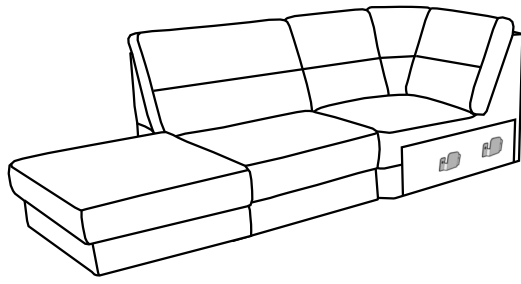
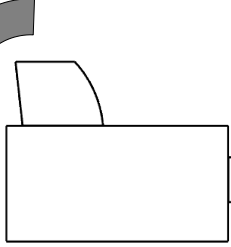

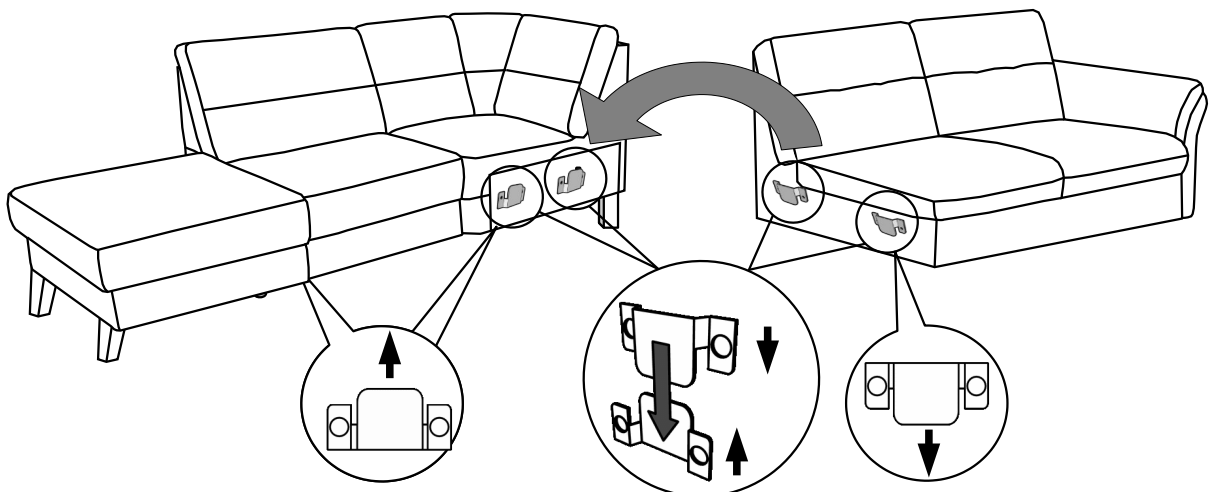
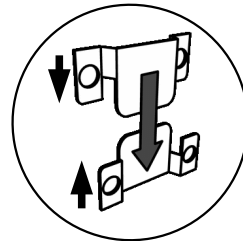
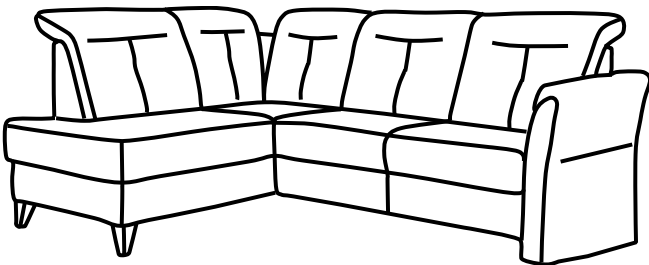
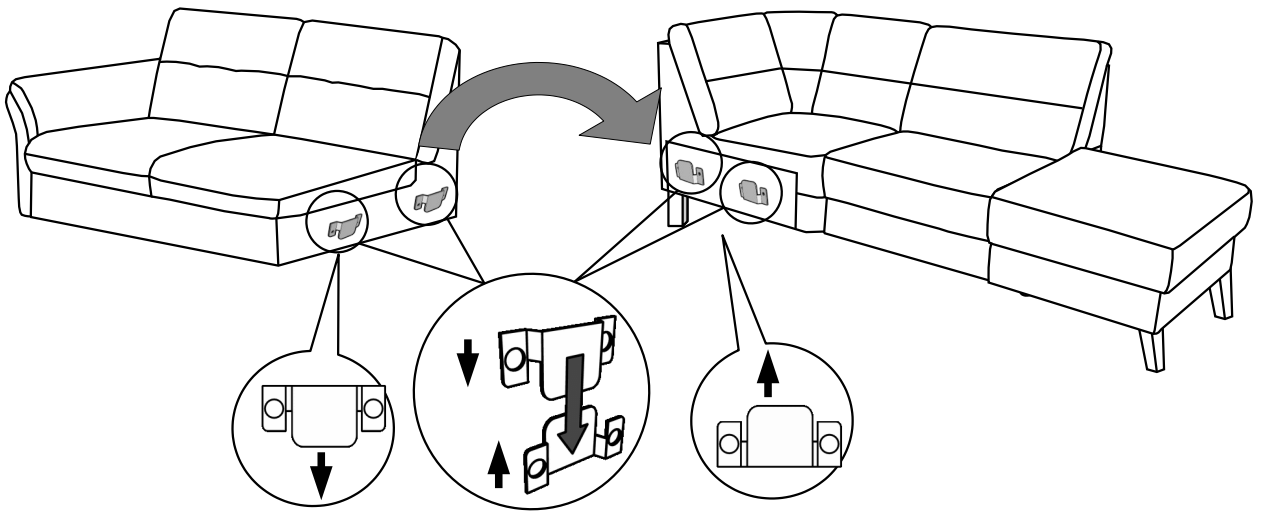
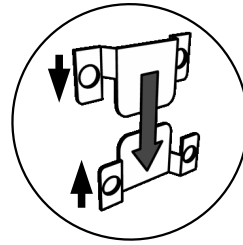
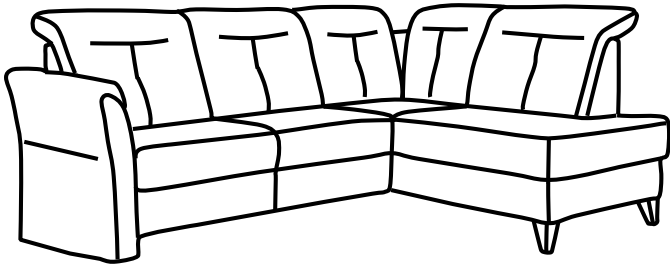

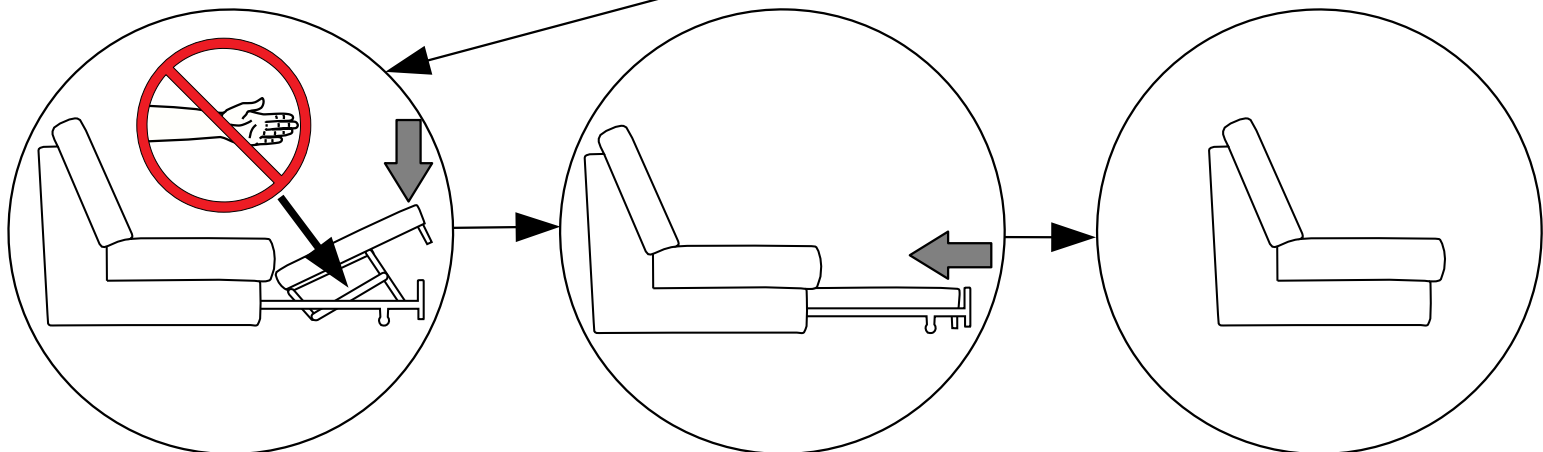
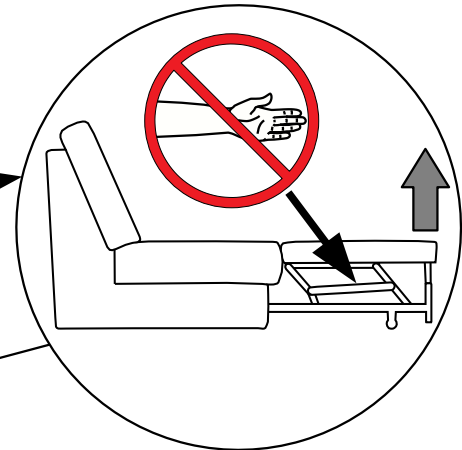
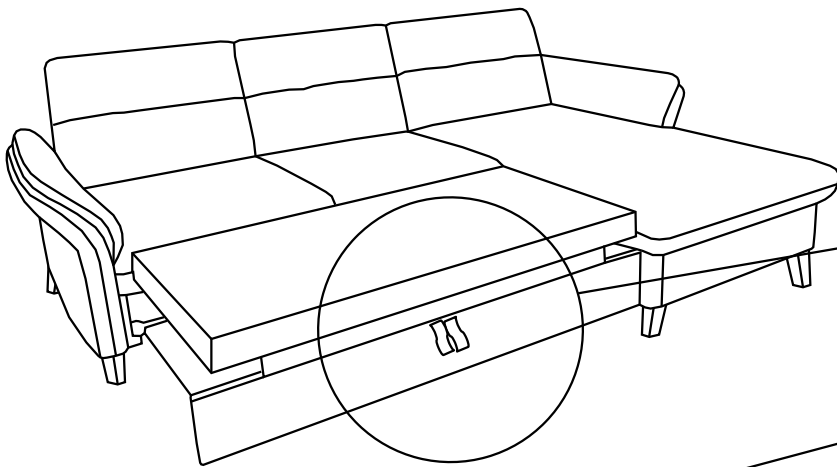
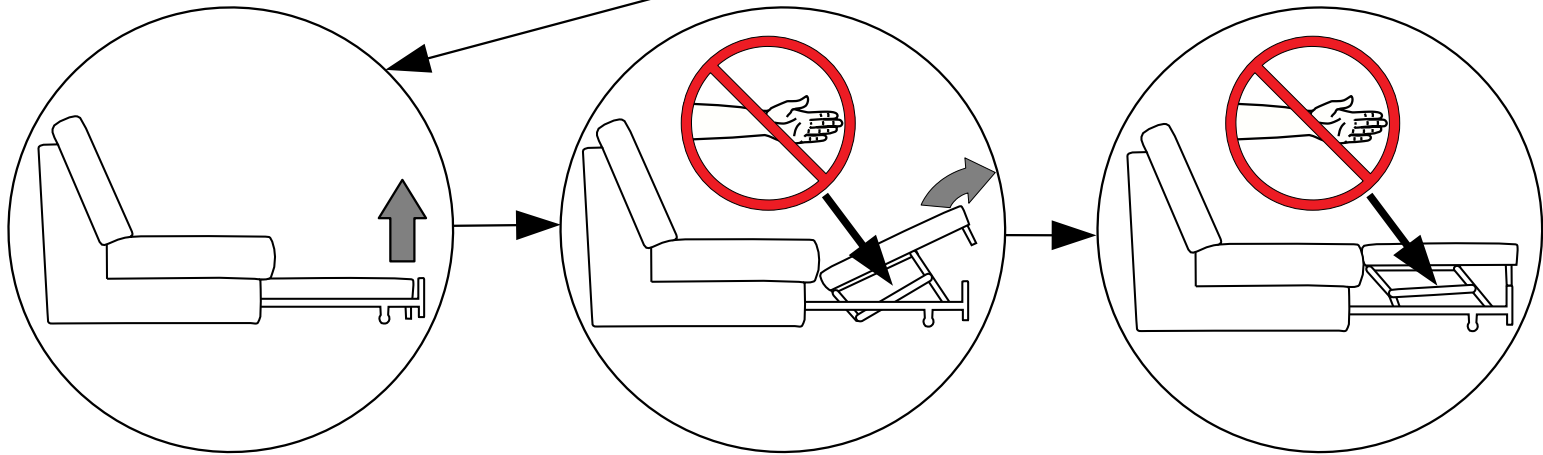
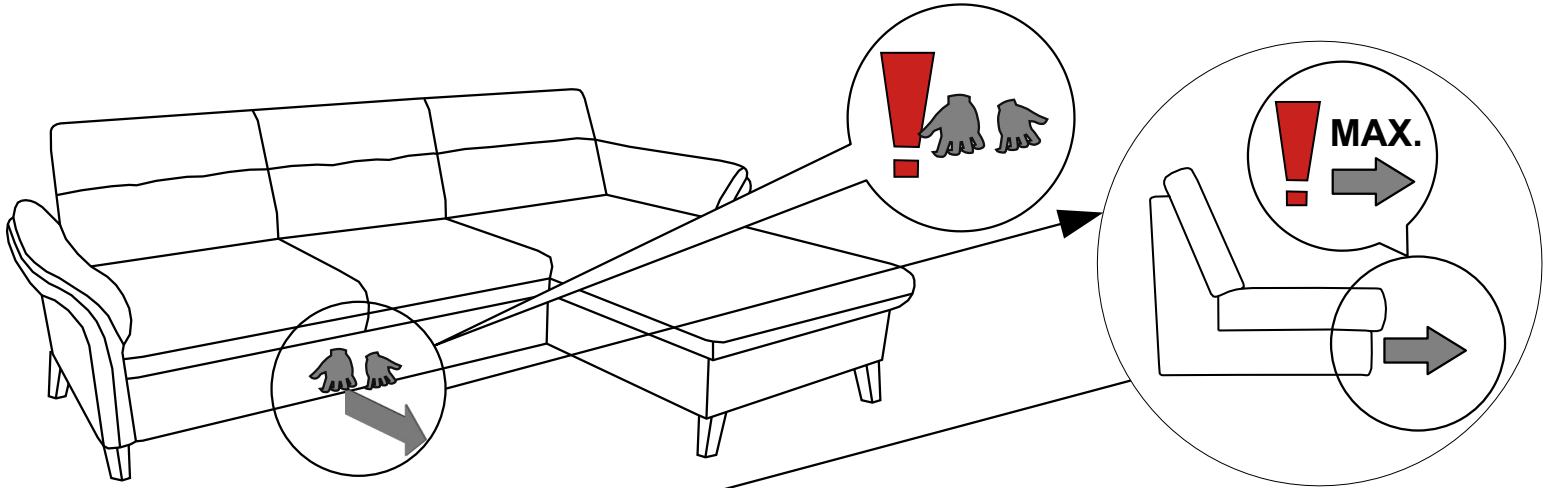
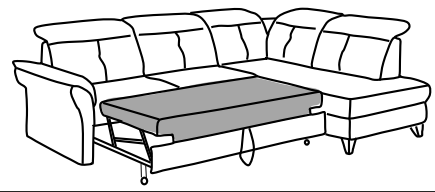
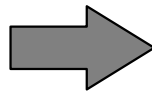
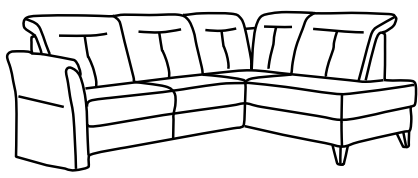

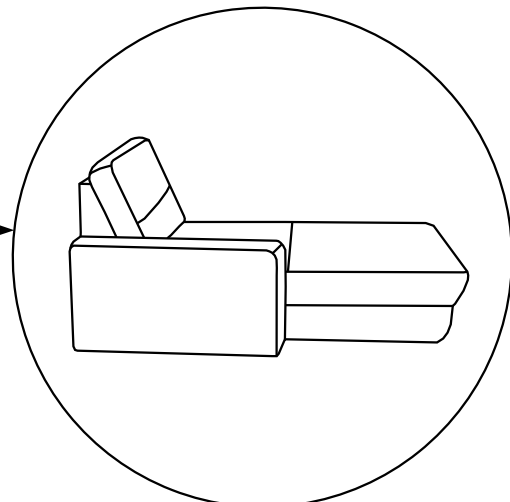
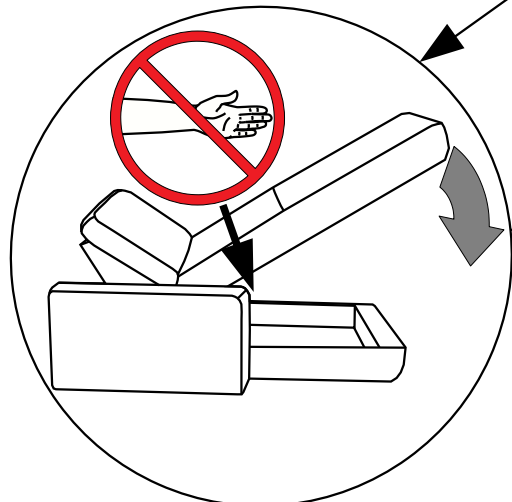
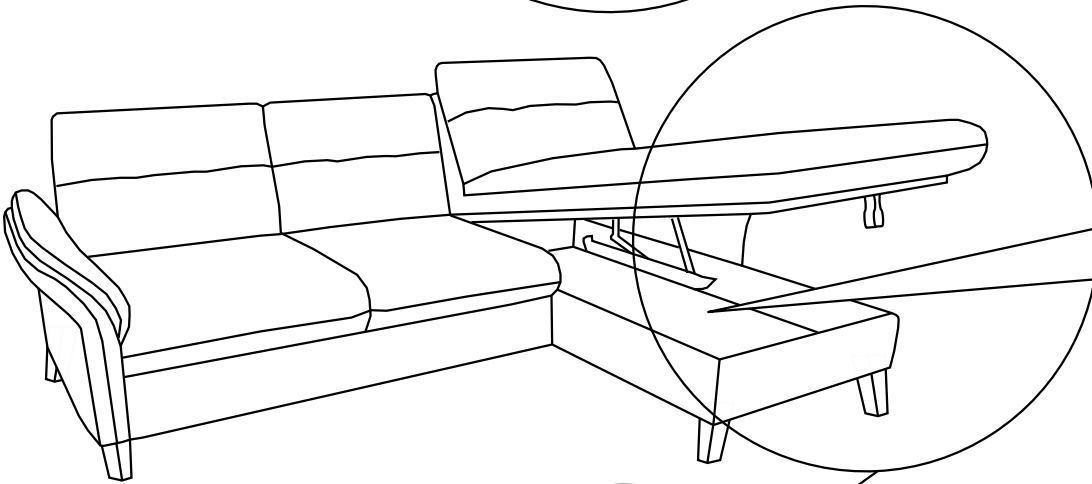
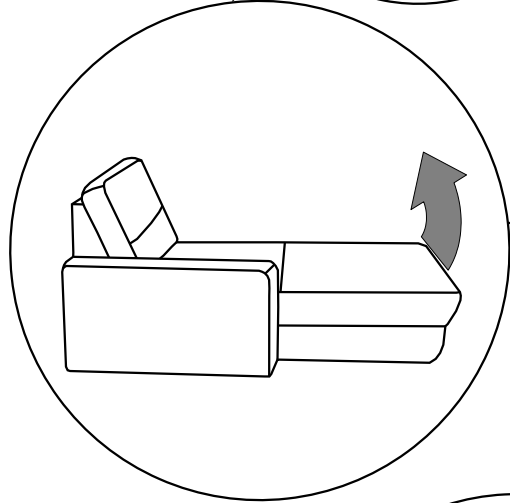
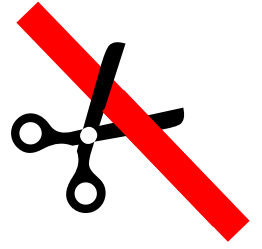
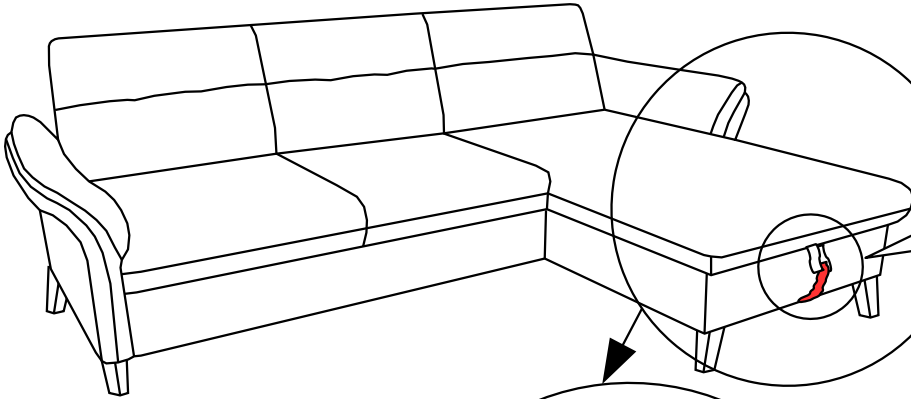
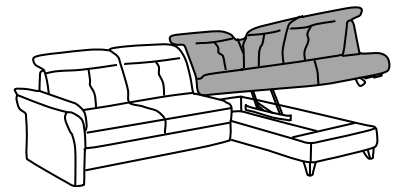
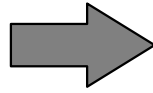
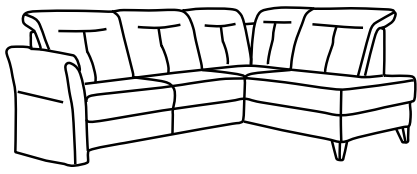

V2 V3 V4 V5

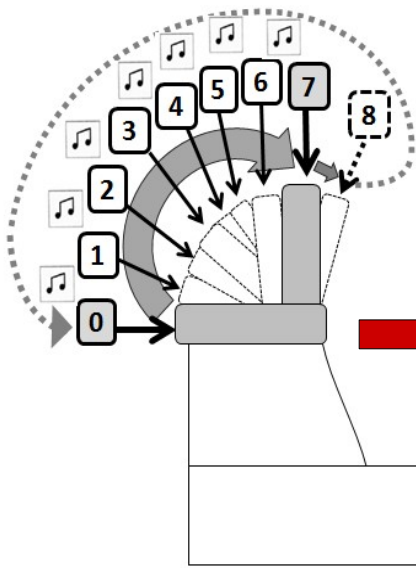
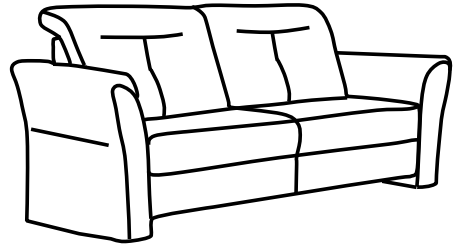
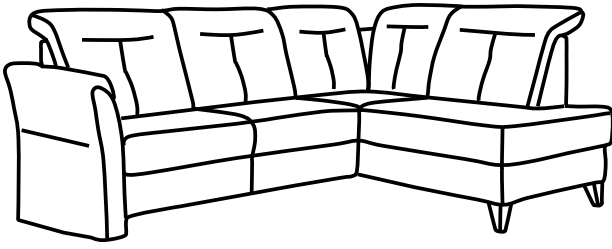

7x

