

3

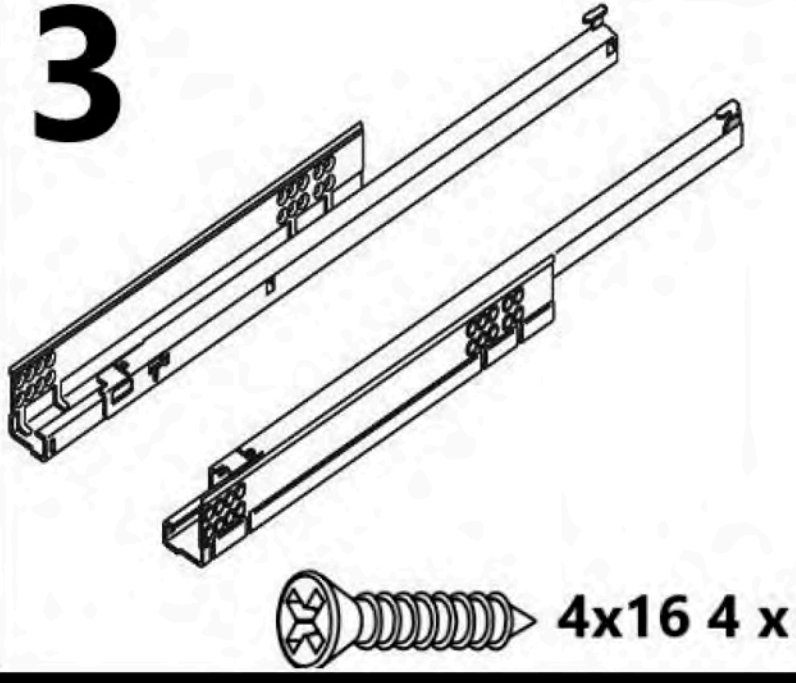

3305-92

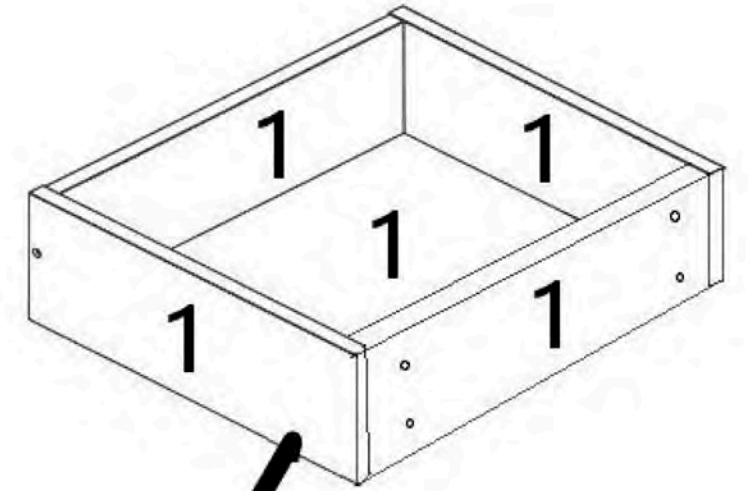

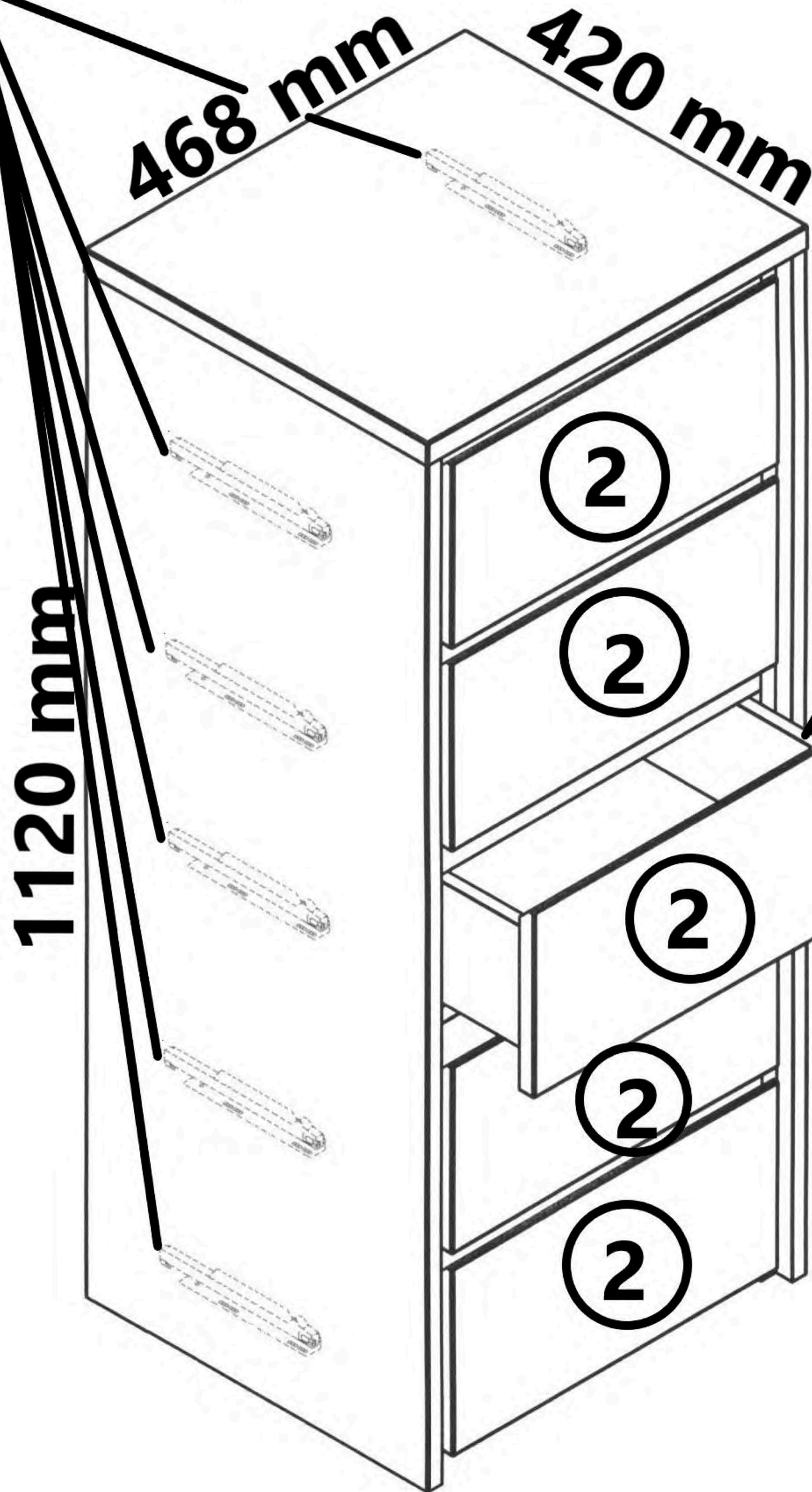

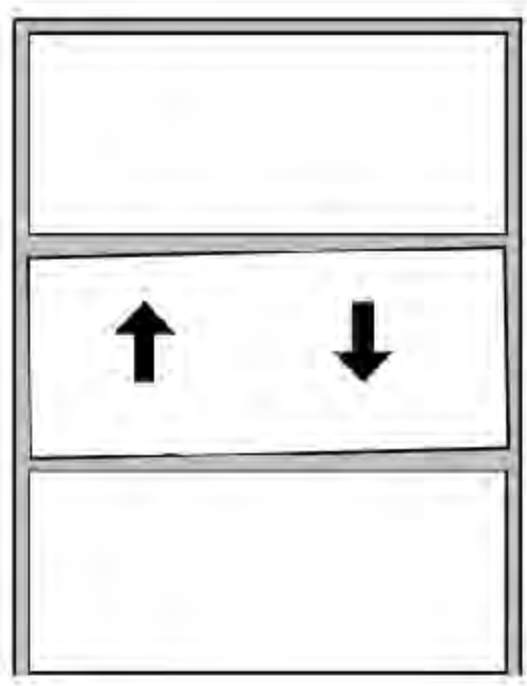

+ - 2 mm

1.

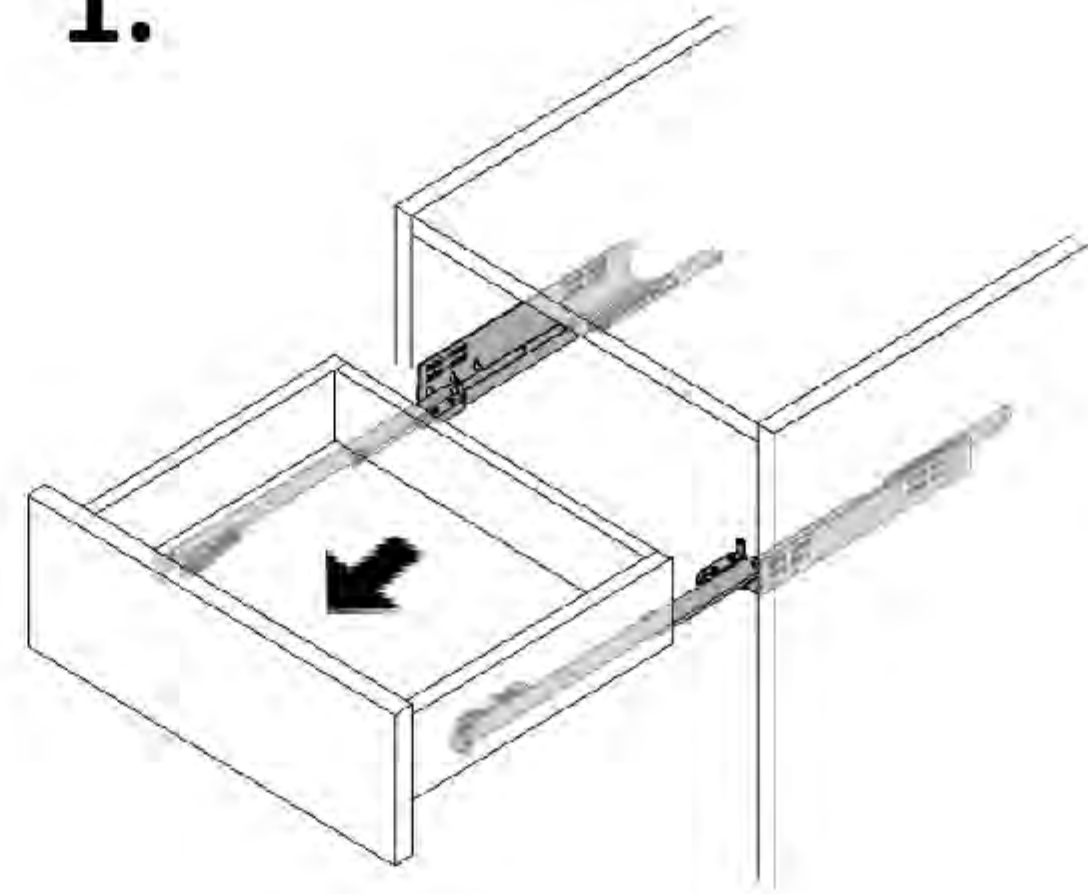

2.

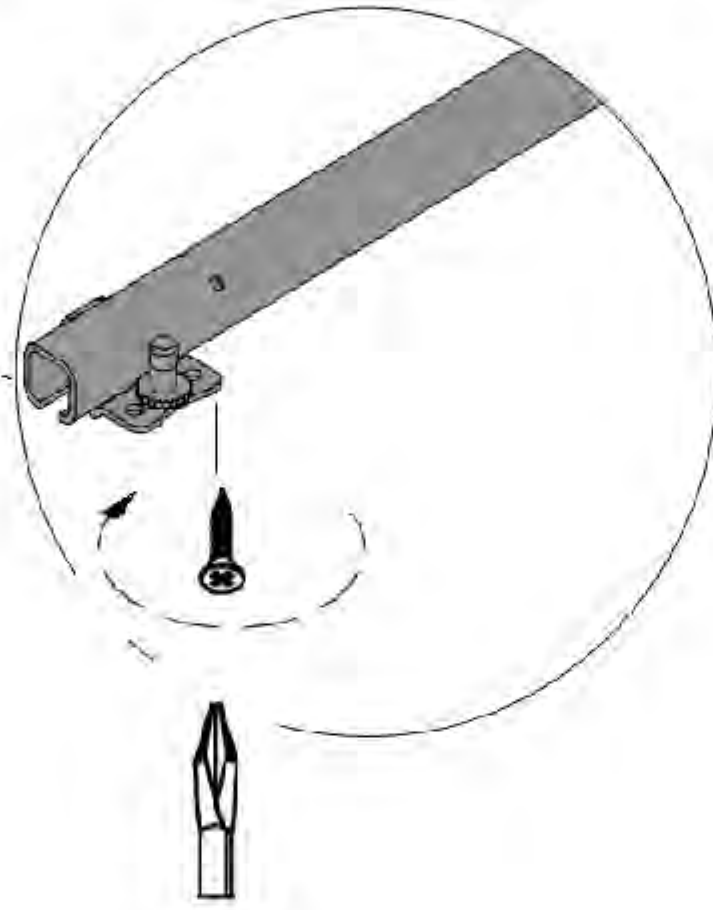
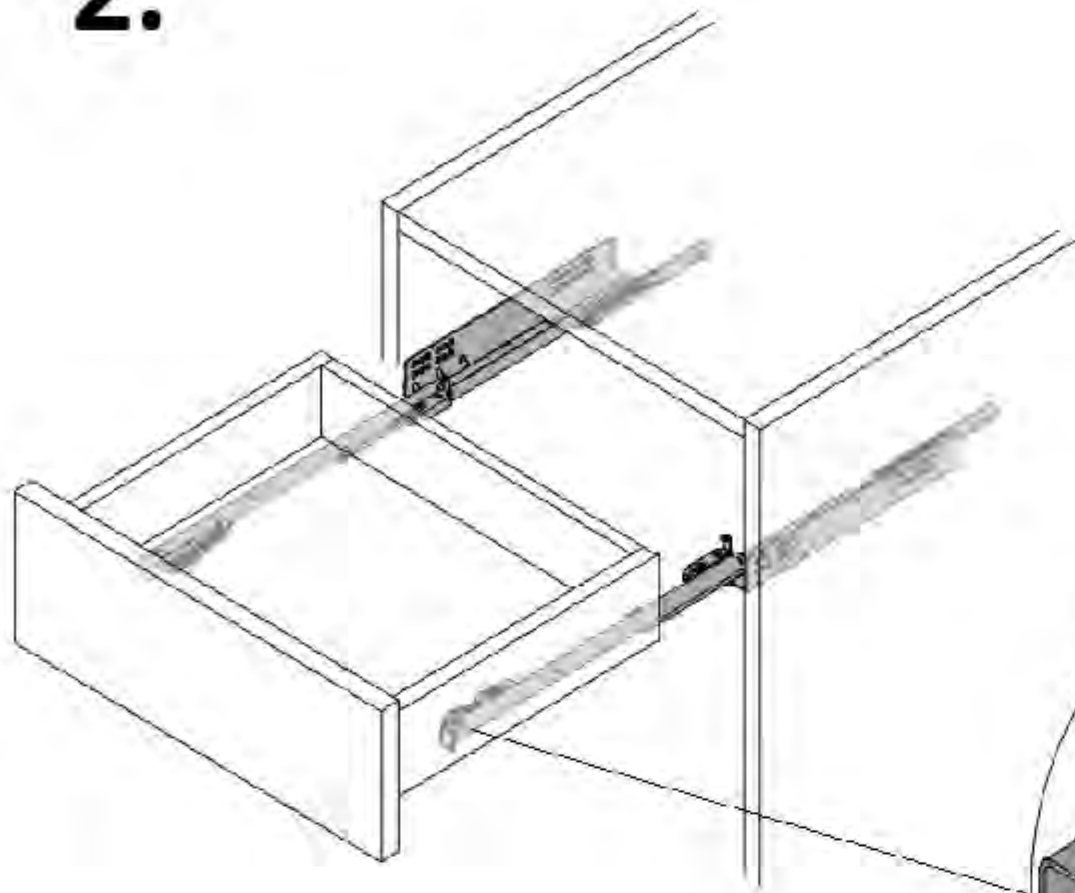

3.

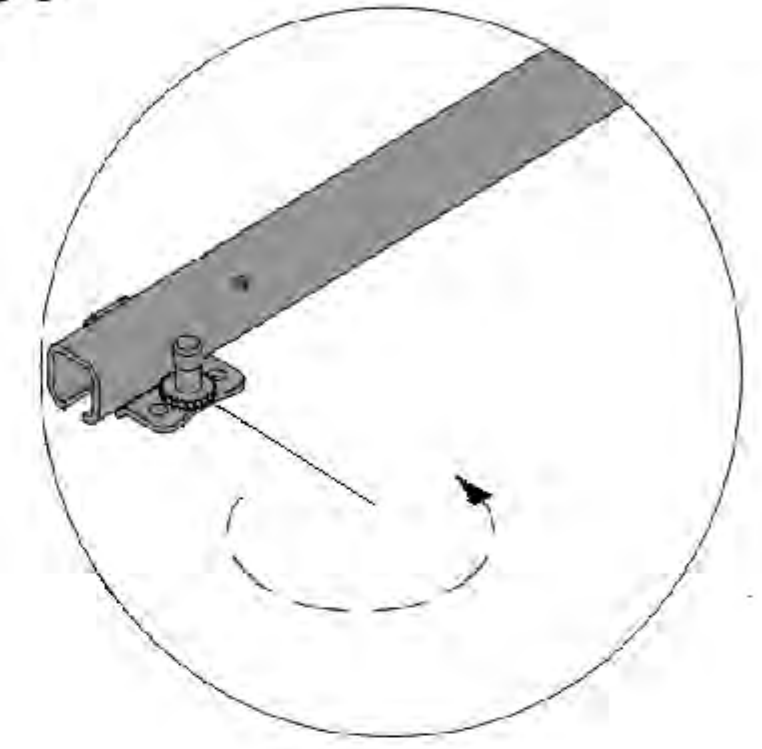

4.

