

Assembly Instruction / Montageanleitung

WF324457+WF324458

Sideboard

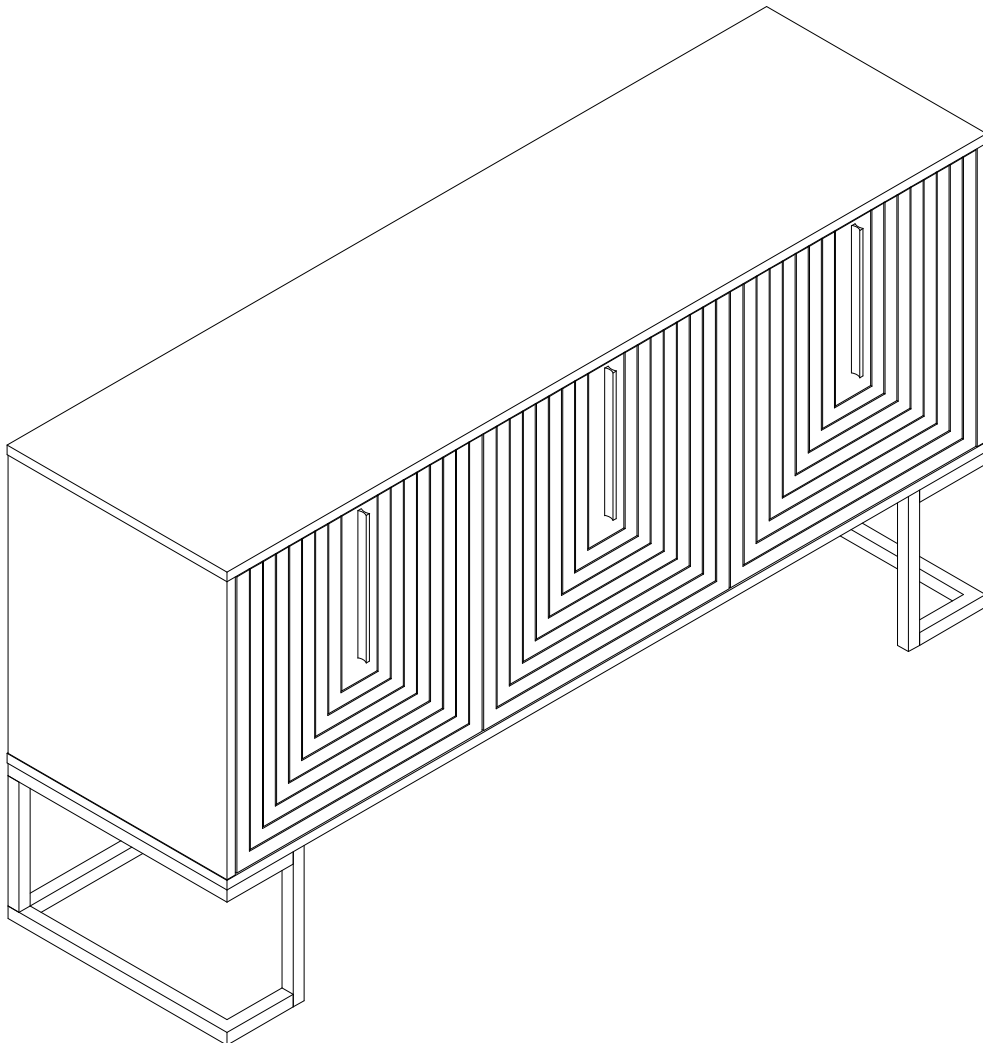

Our product will be delivered to you in 2 packages. The delivery times of these 2 packages may differ, please be patient and thank you for your understanding. Please read these instructions fully before starting assembly:

Tools required: Phillips screwdriver (medium & large)

1. Check you have all the components and tools listed on the following pages.
2. Remove all fittings from the plastic bags and separate them into their groups.
3. Keep children and animals away from the work area, small parts could choke if swallowed.
4. Make sure you have enough space to layout the parts before starting.
5. During assembly do not stand or put weight on the product, this could cause damage.
6. Assemble the item as close to its final position (in the same room) as possible.
7. Assemble on a soft level surface to avoid damaging the unit or your floor.
8. Parts of the assembly will be easier with 2 people.
9. To reduce the likelihood of damaging your product please ensure that your power drill is set on a low torque setting.
10. Assemble all parts and bolts loosely during assembly, only once the product is complete should you fully tighten the bolts.
11. Regularly check and ensure that all bolts and fittings are tightened properly.
12. Please do not place items that exceed the load capacity.

Care and maintenance:

Only clean using a damp cloth and mild detergent, do not use bleach or abrasive cleaners.

Unser Produkt wird Ihnen in 2 Paketen geliefert. Die Lieferzeiten dieser 2 Pakete können abweichen, bitte haben Sie etwas Geduld und vielen Dank für Ihr Verständnis. Bitte lesen Sie diese Anweisungen vollständig durch, bevor Sie mit der Montage beginnen: Erforderliches Werkzeug: Kreuzschlitzschraubendreher (mittel und groß)

1. Überprüfen Sie, ob alle auf den folgenden Seiten aufgeführten Komponenten und Werkzeuge vorhanden sind.

2. Entfernen Sie alle Zubehörteile aus den Plastiktüten und teilen Sie sie in ihre Gruppen auf.

3. Halten Sie Kinder und Tiere vom Arbeitsbereich fern, es besteht Erstickungsgefahr durch Kleinteile wenn verschluckt.

4. Stellen Sie sicher, dass Sie genügend Platz zum Anordnen der Teile haben, bevor Sie beginnen.

5. Stellen Sie sich während der Montage nicht auf das Produkt und belasten Sie es nicht, da dies zu Schäden führen kann.

6. Bauen Sie den Artikel so nah wie möglich an seiner endgültigen Position (im selben Raum) zusammen.

7. Stellen Sie das Gerät auf eine weiche, ebene Oberfläche, um eine Beschädigung des Geräts oder Ihres Bodens zu vermeiden.

8. Teile der Montage lassen sich einfacher mit 2 Personen durchführen.

9. Um die Wahrscheinlichkeit einer Beschädigung Ihres Produkts zu verringern, stellen Sie bitte sicher, dass Ihre Bohrmaschine auf ein niedriges Drehmoment eingestellt ist.

10. Setzen Sie alle Teile und Schrauben während der Montage locker zusammen. Erst wenn das Produkt fertig ist, sollten Sie die Schrauben vollständig festziehen.

11. Überprüfen Sie regelmäßig und stellen Sie sicher, dass alle Schrauben und Anschlüsse ordnungsgemäß festgezogen sind.

12. Bitte platzieren Sie keine Gegenstände, die die Tragfähigkeit überschreiten.

Pflege und Wartung:

Reinigen Sie es nur mit einem feuchten Tuch und einem milden Reinigungsmittel.

Verwenden Sie keine Bleichmittel oder Scheuermittel.

Assembly Instruction / Montageanleitung

ITEM:WF324457&WF324458

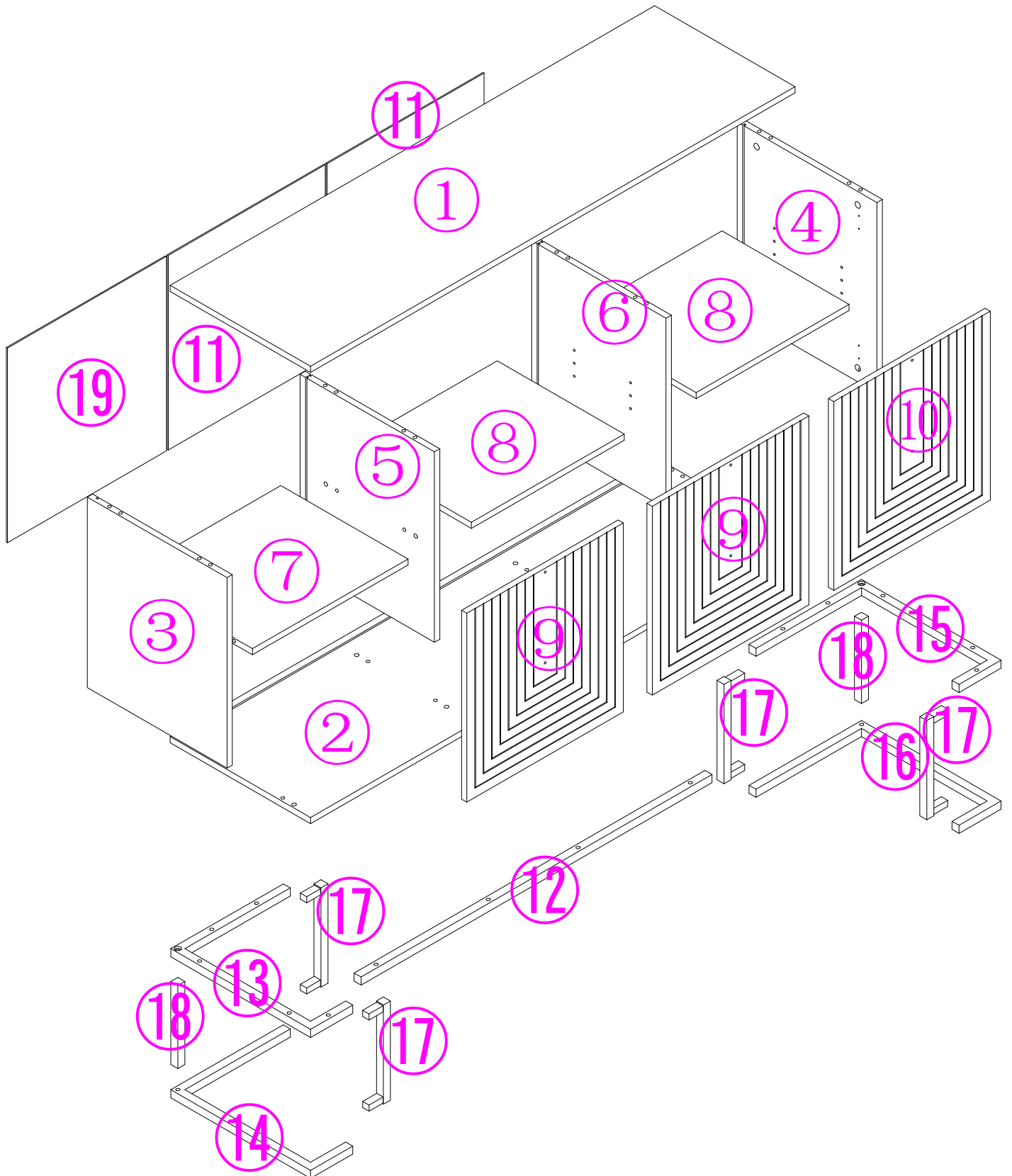



Part List / Stückliste

Please check you have all the panels listed below

/Bitte überprüfen Sie, ob alle unten aufgeführten Panels vorhanden sind

Note: The quantities below are the correct amount to complete the assembly. In some cases more fittings may be supplied than are required. / Hinweis: Die unten angegebenen Mengen sind die richtigen Mengen, um die Montage abzuschließen. In manchen Fällen können mehr Armaturen geliefert werden, als erforderlich sind.

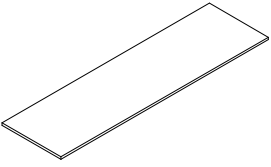
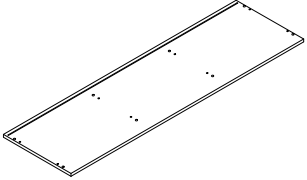
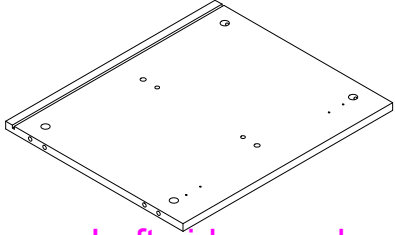
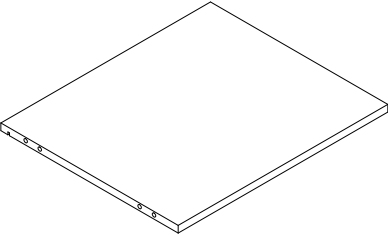
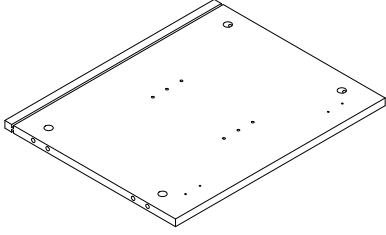
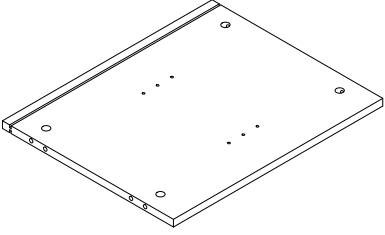
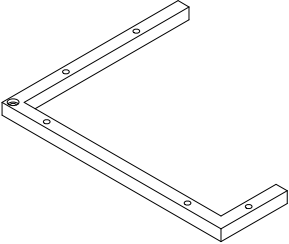
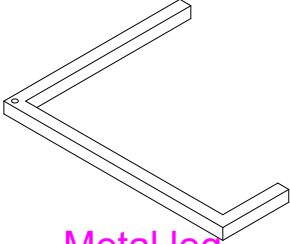
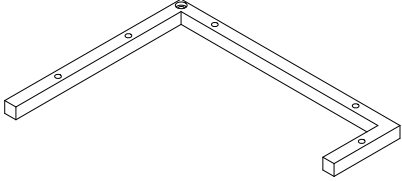
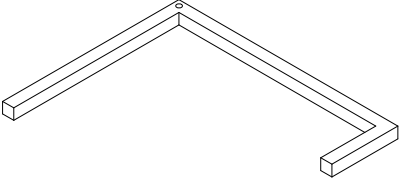
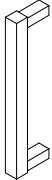
WF324457

<p>① x 1</p>  <p>Top panel</p>	<p>② x 1</p>  <p>Bottom panel</p>	<p>③ x 1</p>  <p>Left side panel</p>
<p>④ x 1</p>  <p>Right side panel</p>	<p>⑤ x 1</p>  <p>Left Middle panel</p>	<p>⑥ x 1</p>  <p>Right Middle panel</p>
<p>⑬ x 1</p>  <p>Metal leg</p>	<p>⑭ x 1</p>  <p>Metal leg</p>	<p>⑮ x 1</p>  <p>Metal leg</p>
<p>⑯ x 1</p>  <p>Metal leg</p>	<p>⑰ x 4</p>  <p>Metal leg</p>	<p>⑱ x 2</p>  <p>Metal leg</p>

Part List / Stückliste

Please check you have all the panels listed below

/Bitte überprüfen Sie, ob alle unten aufgeführten Panels vorhanden sind

Note: The quantities below are the correct amount to complete the assembly. In some cases more fittings may be supplied than are required. / Hinweis: Die unten angegebenen Mengen sind die richtigen Mengen, um die Montage abzuschließen. In manchen Fällen können mehr Armaturen geliefert werden, als erforderlich sind.

WF324458

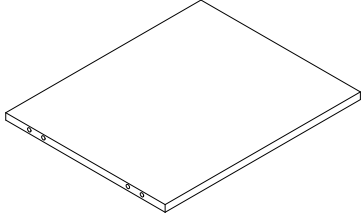
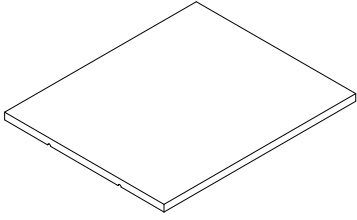
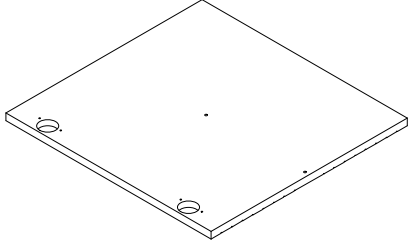
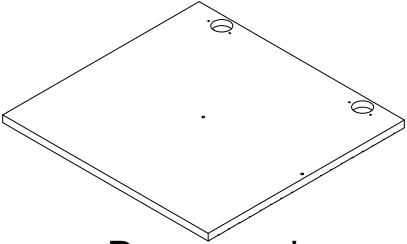
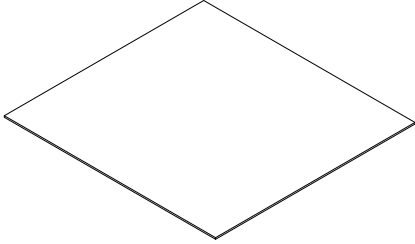
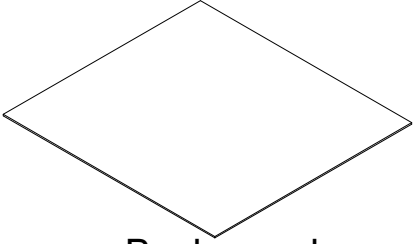
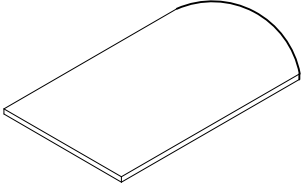
<p>⑦ X 1</p>  <p>Shelf panel</p>	<p>⑧ X 2</p>  <p>Shelf panel</p>	<p>⑨ X 2</p>  <p>Door panel</p>
<p>⑩ X 1</p>  <p>Door panel</p>	<p>⑪ X 2</p>  <p>Back panel</p>	<p>⑲ X 1</p>  <p>Back panel</p>
 <p>Hardware kit</p>		

Hardware list / Hardwareliste













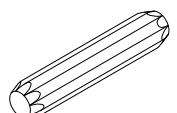

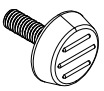

ITEM:WF324457&WF324458

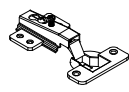
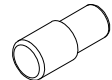
Please check you have all the panels listed below

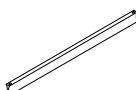
/Bitte überprüfen Sie, ob alle unten aufgeführten Panels vorhanden sind

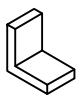
Note: The quantities below are the correct amount to complete the assembly. In some cases more fittings may be supplied than are required. / Hinweis: Die unten angegebenen Mengen sind die richtigen Mengen, um die Montage abzuschließen. In manchen Fällen können mehr Armaturen geliefert werden, als erforderlich sind.

WF324457&WF324458

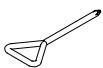
 <p>A1 x 20 eccentric rod</p>	 <p>A2 x 20 eccentric rod gear</p>	 <p>8x40mm B x 20 Dowels</p>	 <p>3.5x14 C x 48 Screws</p>	 <p>6x30mm D x 14 Bolts</p>	 <p>6x20mm E x 20 Bolts</p>
 <p>F x 6 Adjustable footres</p>	 <p>G x 4 Hook</p>	 <p>H x 2 Hook</p>	 <p>J x 8 Shelf support</p>	 <p>K x 20 Perfect cover</p>	 <p>L x 12 panel hook</p>
 <p>M1 x 3 Handles</p>	 <p>6x18mm M2 x 6 Bolts</p>	 <p>N1 x 2 Anti collapse</p>	 <p>N2 x 2 Anti collapse</p>	 <p>3.5x14mm N3 x 2 Screws</p>	 <p>3.5x35mm N4x 2 Screws</p>
 <p>N5 x 2 Anchor</p>	 <p>P x 1 Tool</p>				

Assembly Instruction Montageanleitung

ITEM:WF324457&WF324458

Step 1

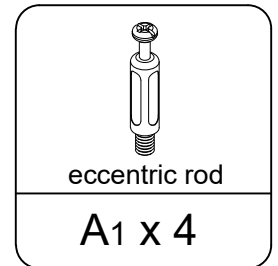
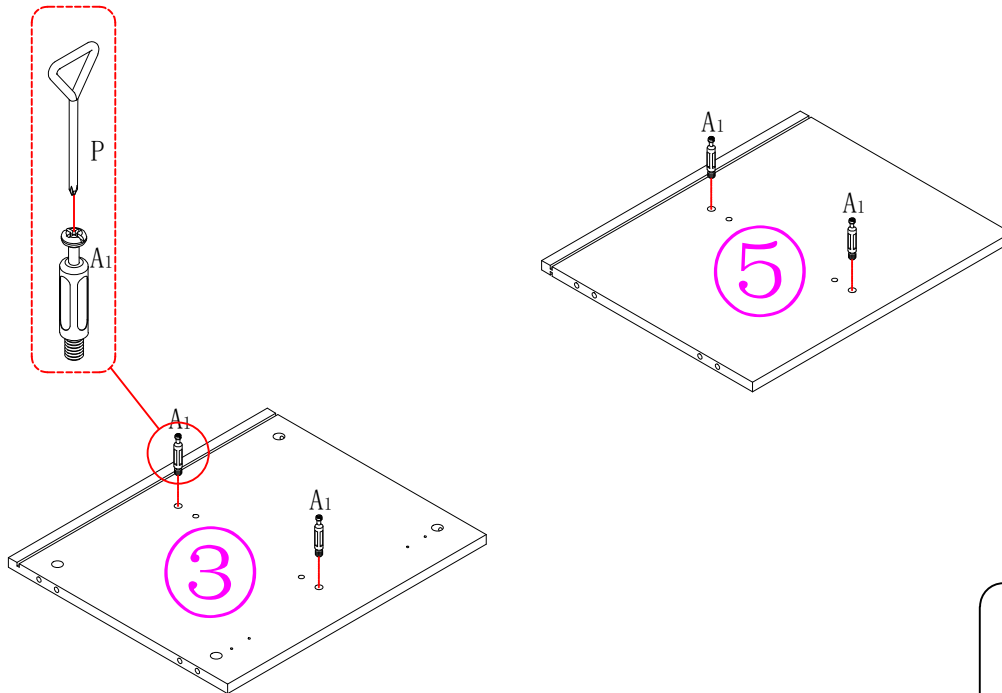

Step 2

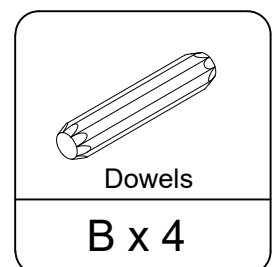
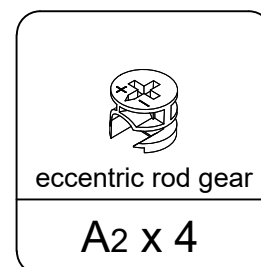
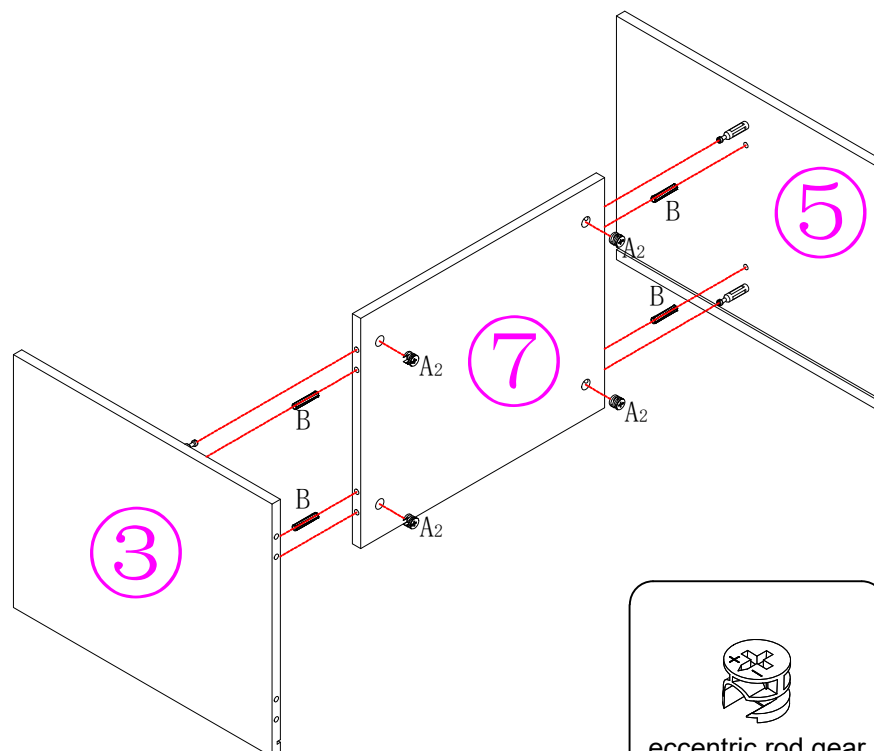

Assembly Instruction / Montageanleitung

ITEM:WF324457&WF324458

Step 3

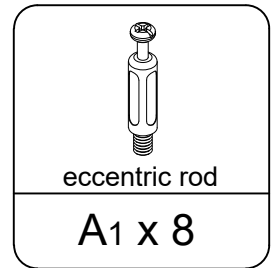
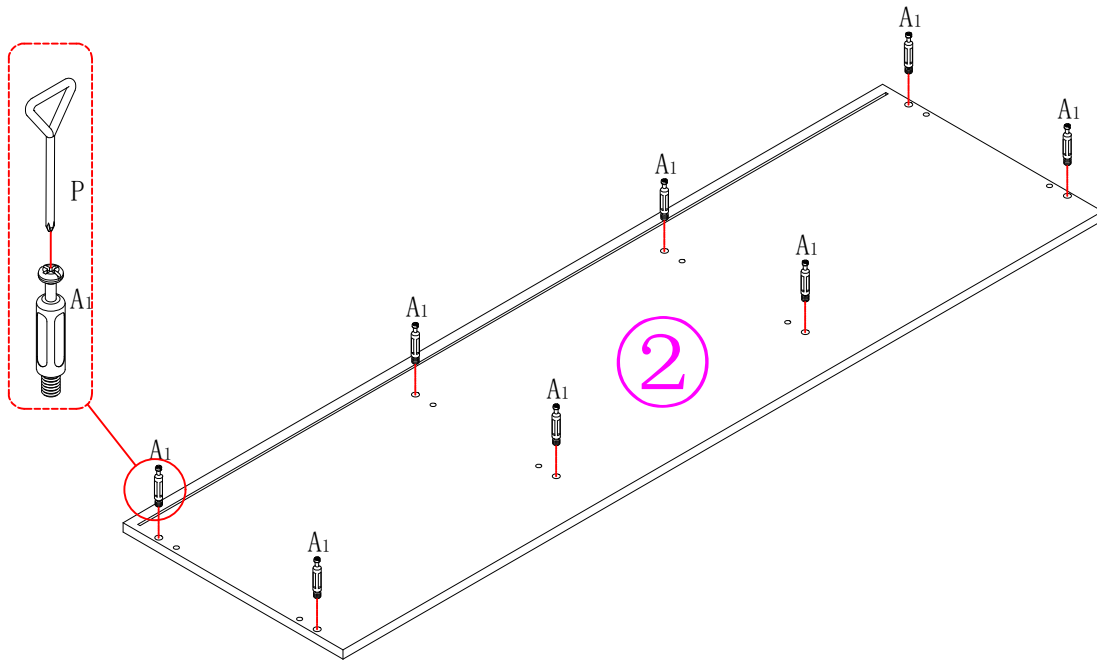

Step 4

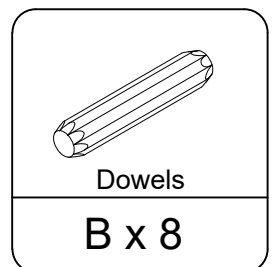
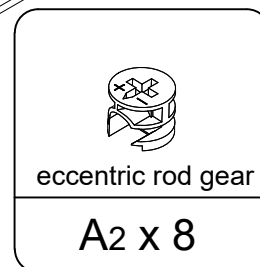
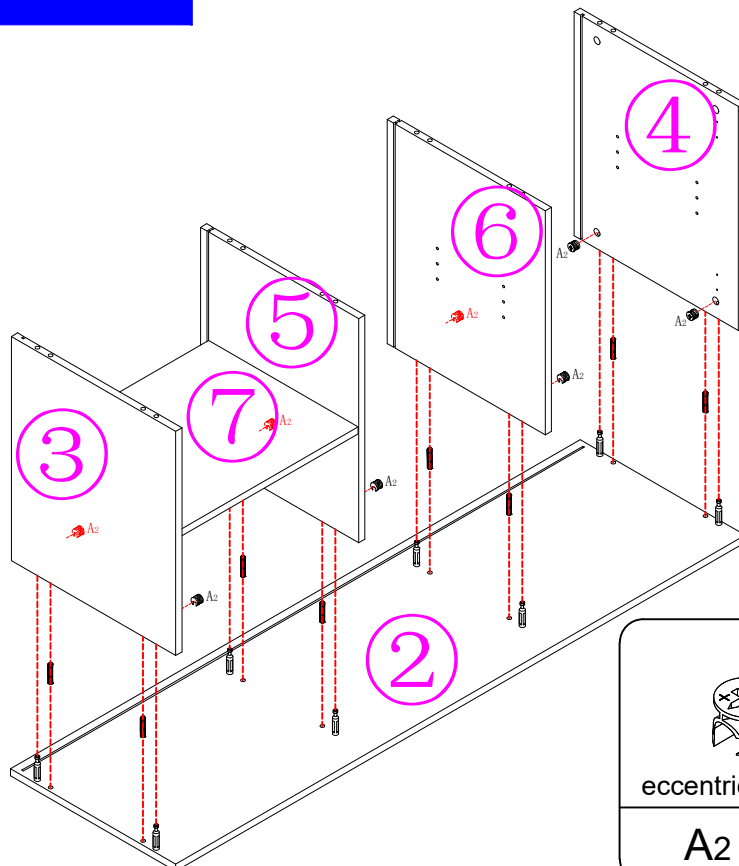

Assembly Instruction / Montageanleitung

ITEM:WF324457&WF324458

Step 5

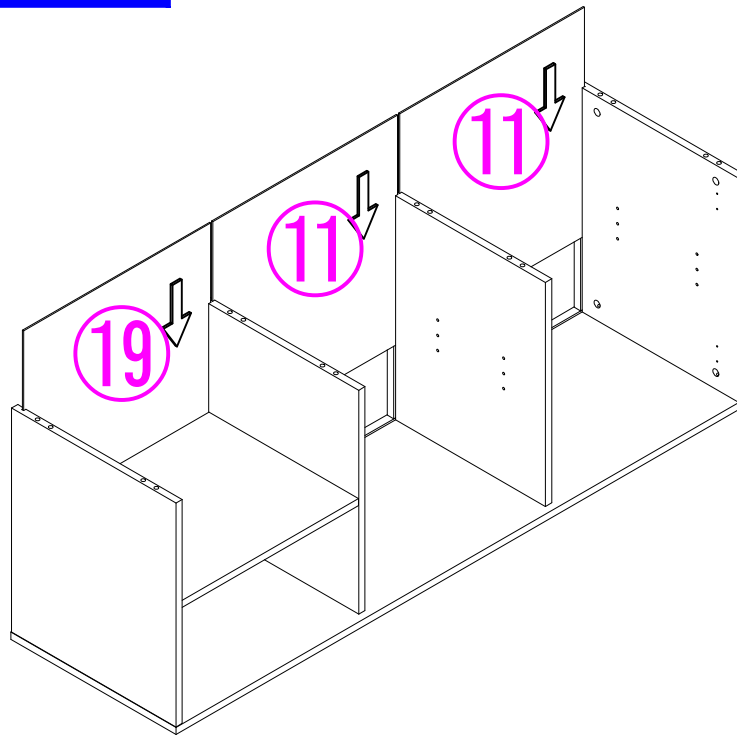

Step 6

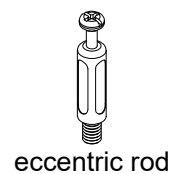
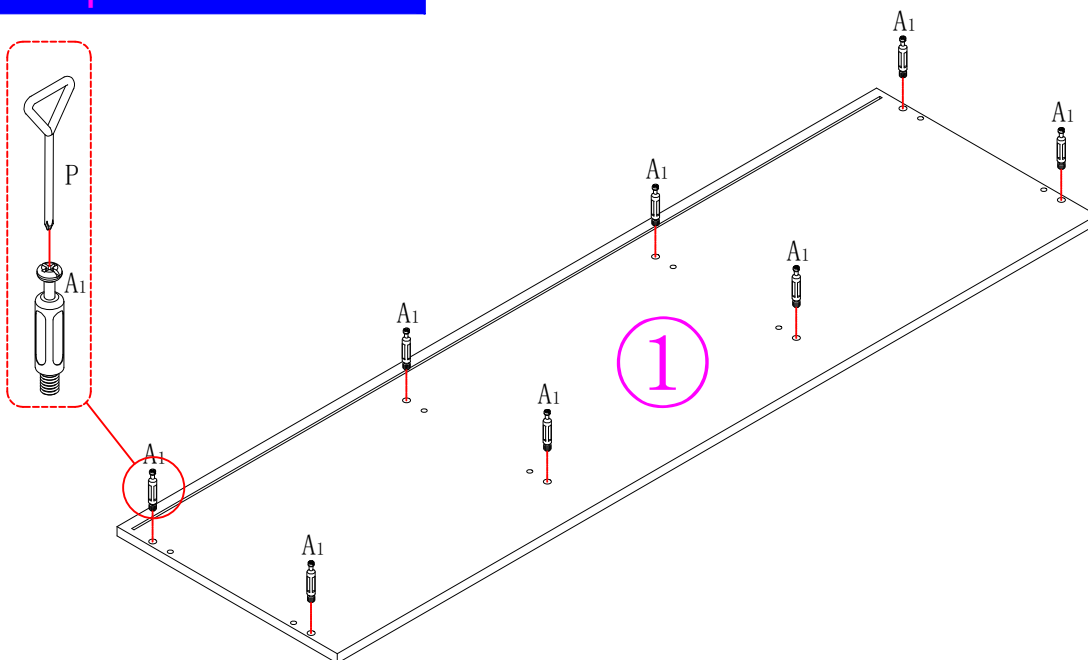

eccentric rod

A1 x 8

Assembly Instruction / Montageanleitung

ITEM:WF324457&WF324458

Step 7

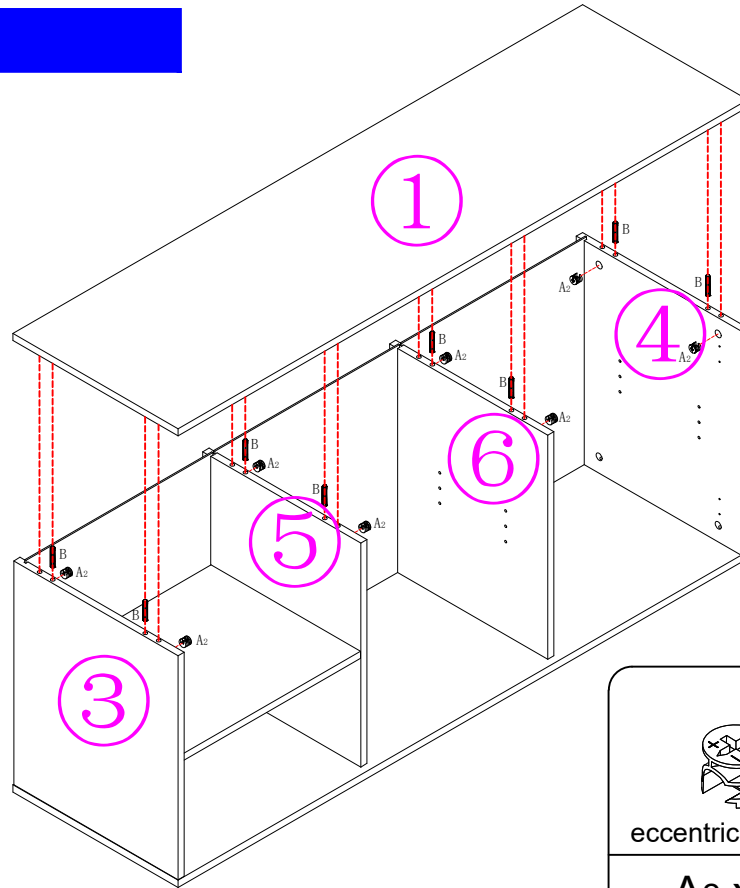

eccentric rod gear

A2 x 8

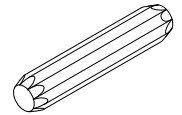

Dowels

B x 8

Step 8

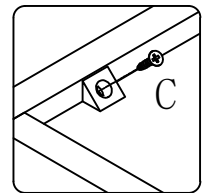
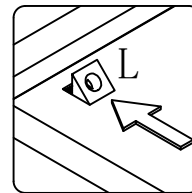
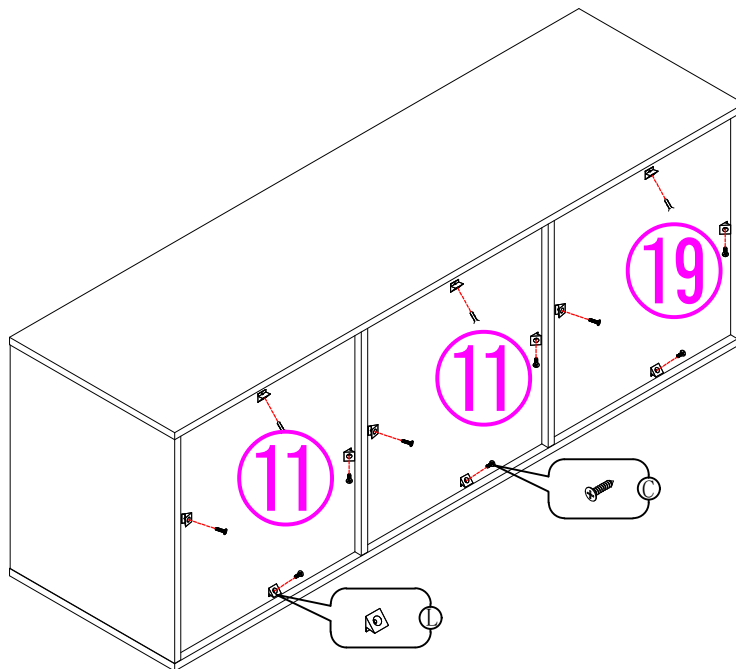

Screws

C x 12



panel hook

L x 12

Assembly Instruction / Montageanleitung

ITEM:WF324457&WF324458

Step 9

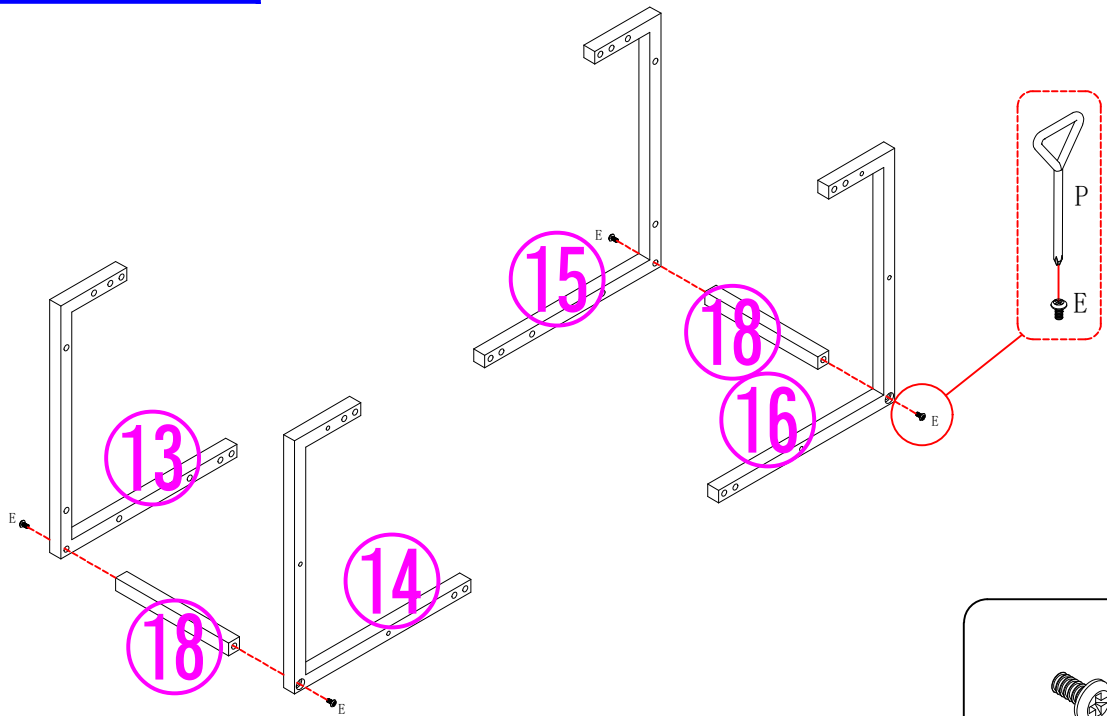

Bolts

E x 4

Step 10

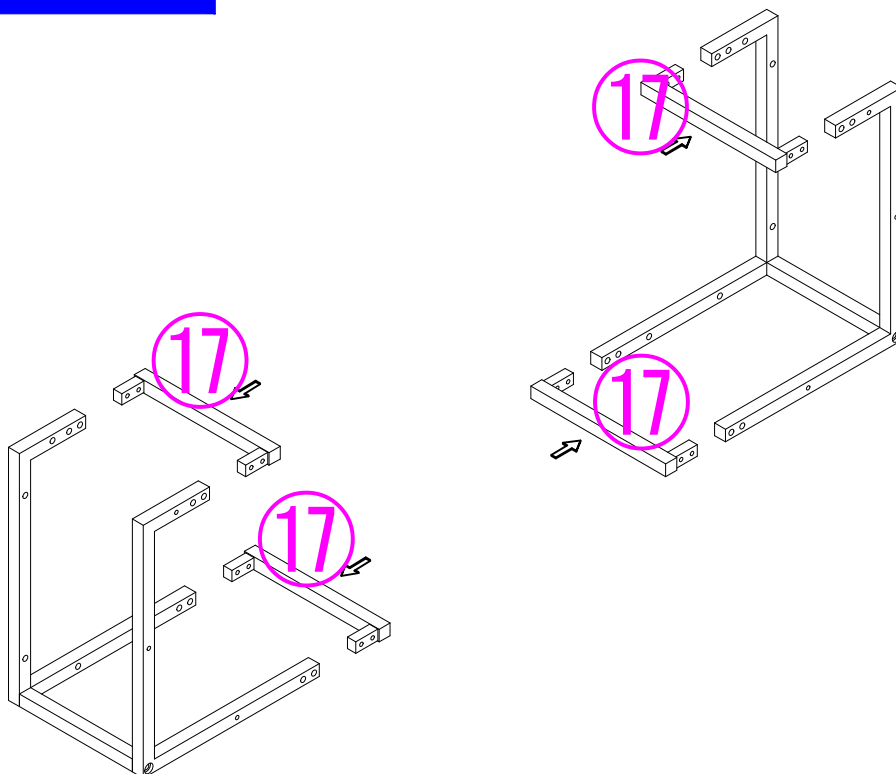

Assembly Instruction / Montageanleitung

ITEM:WF324457&WF324458

Step 11

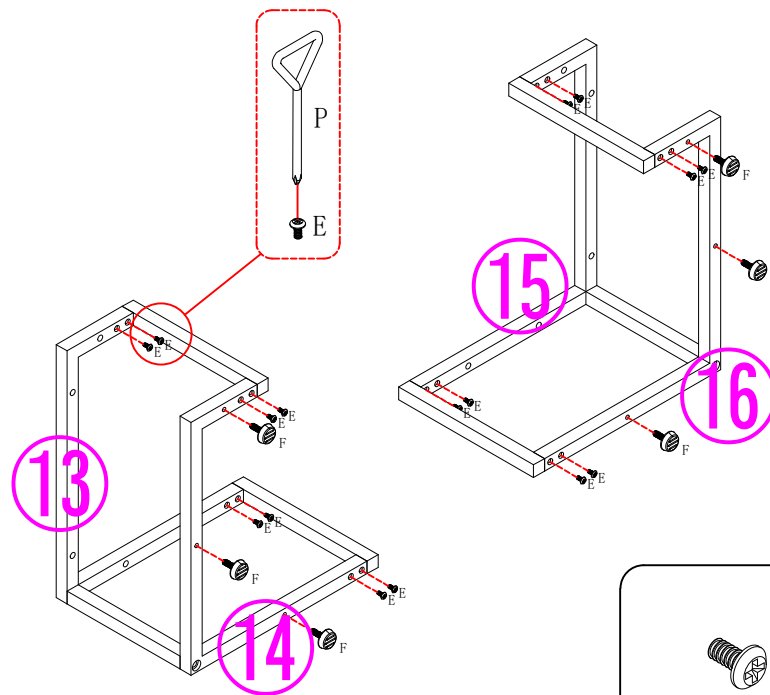

Bolts
E x 16



Adjustable footres
F x 6

Step 12

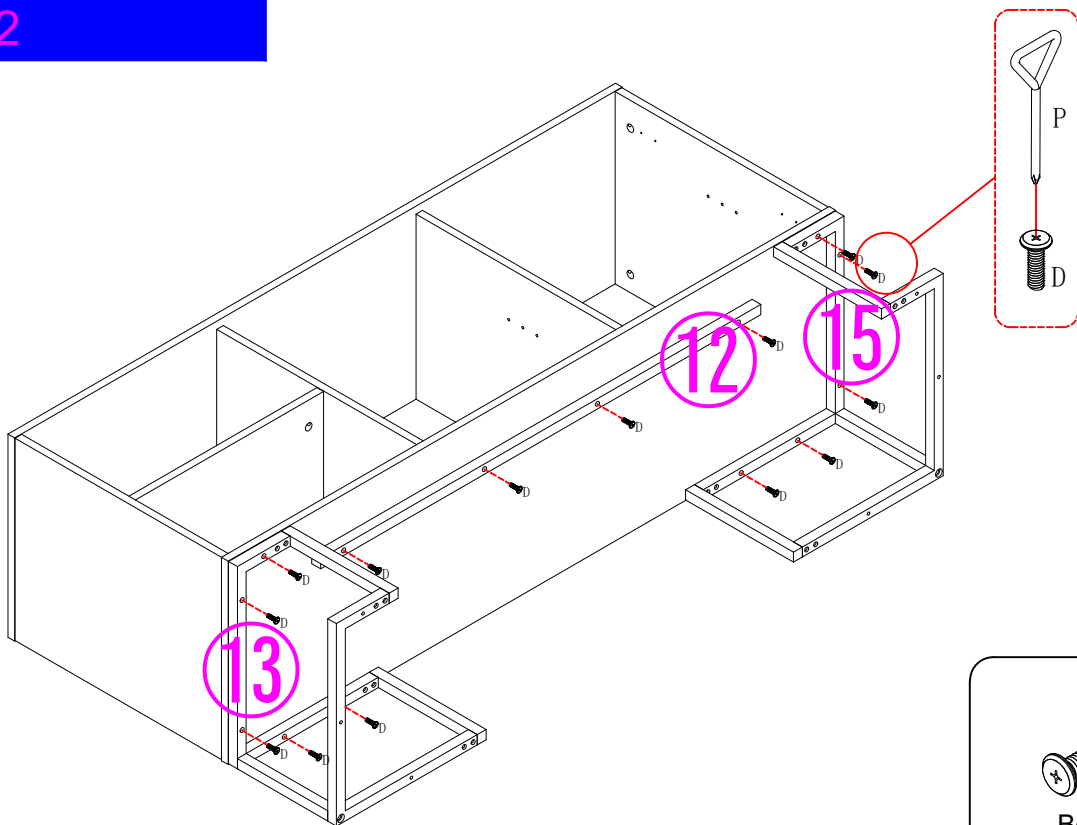

Bolts
D x 14

Assembly Instruction / Montageanleitung

ITEM:WF324457&WF324458

Step 13

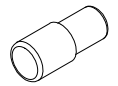
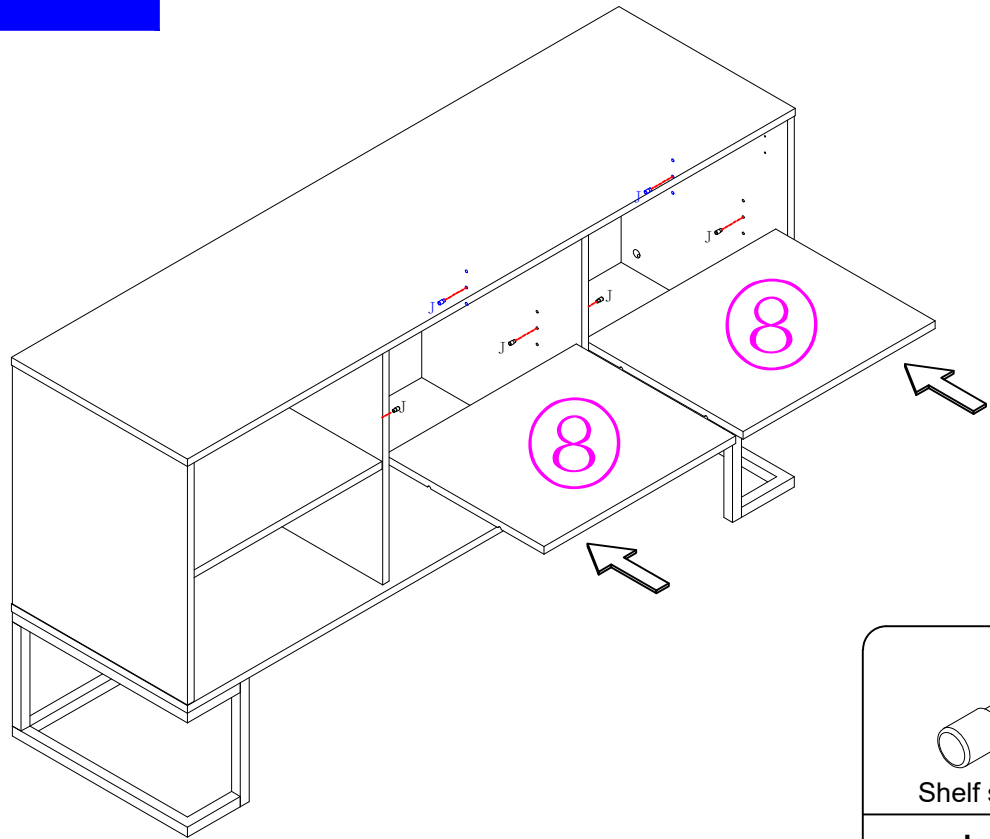

Shelf support

J x 8

Step 14

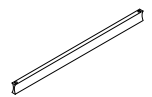
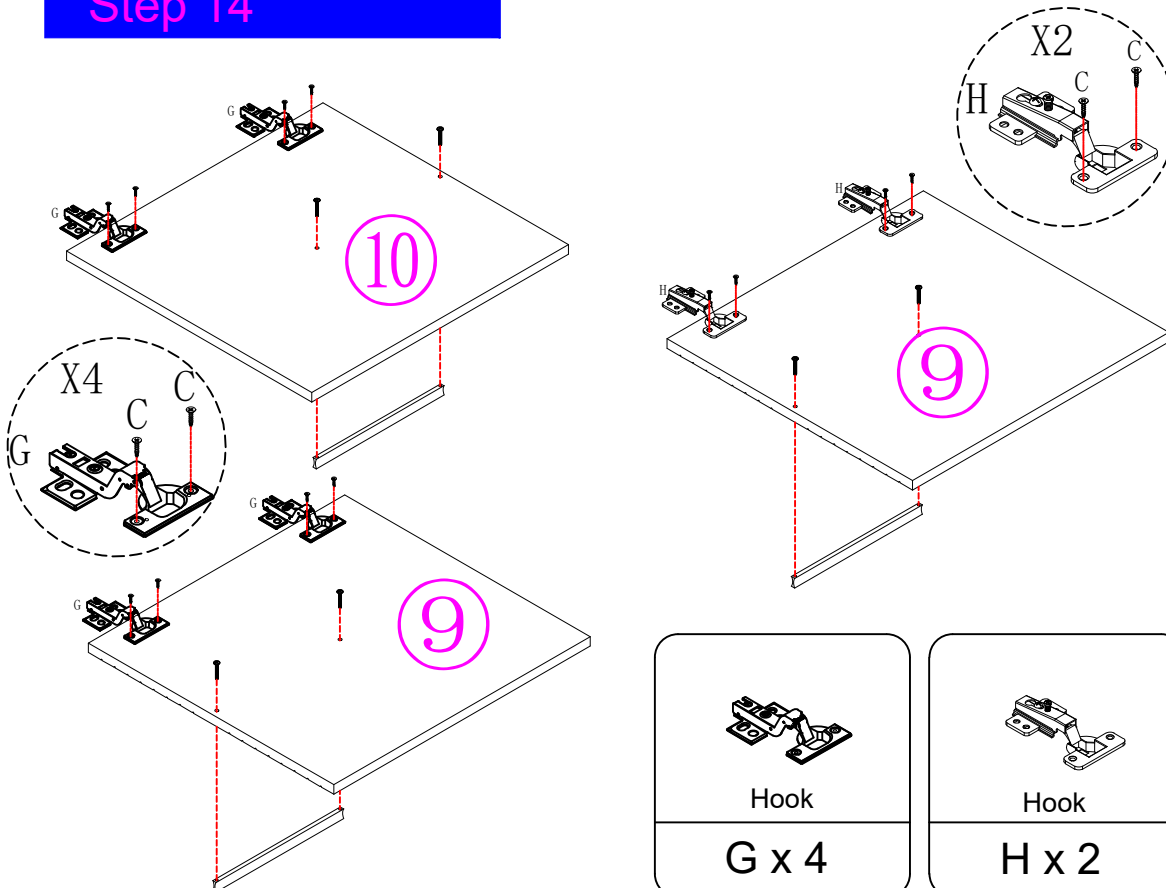

Handles

M1 x 3



Bolts

M2 x 6



Hook

G x 4



Hook

H x 2



Screws

C x 12

Assembly Instruction / Montageanleitung

ITEM:WF324457&WF324458

Step 15

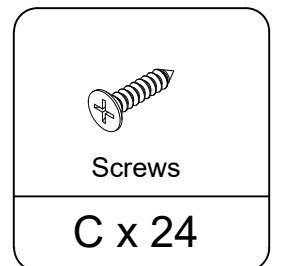
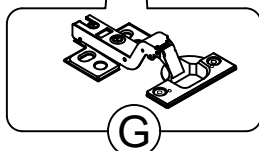
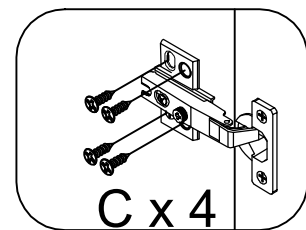
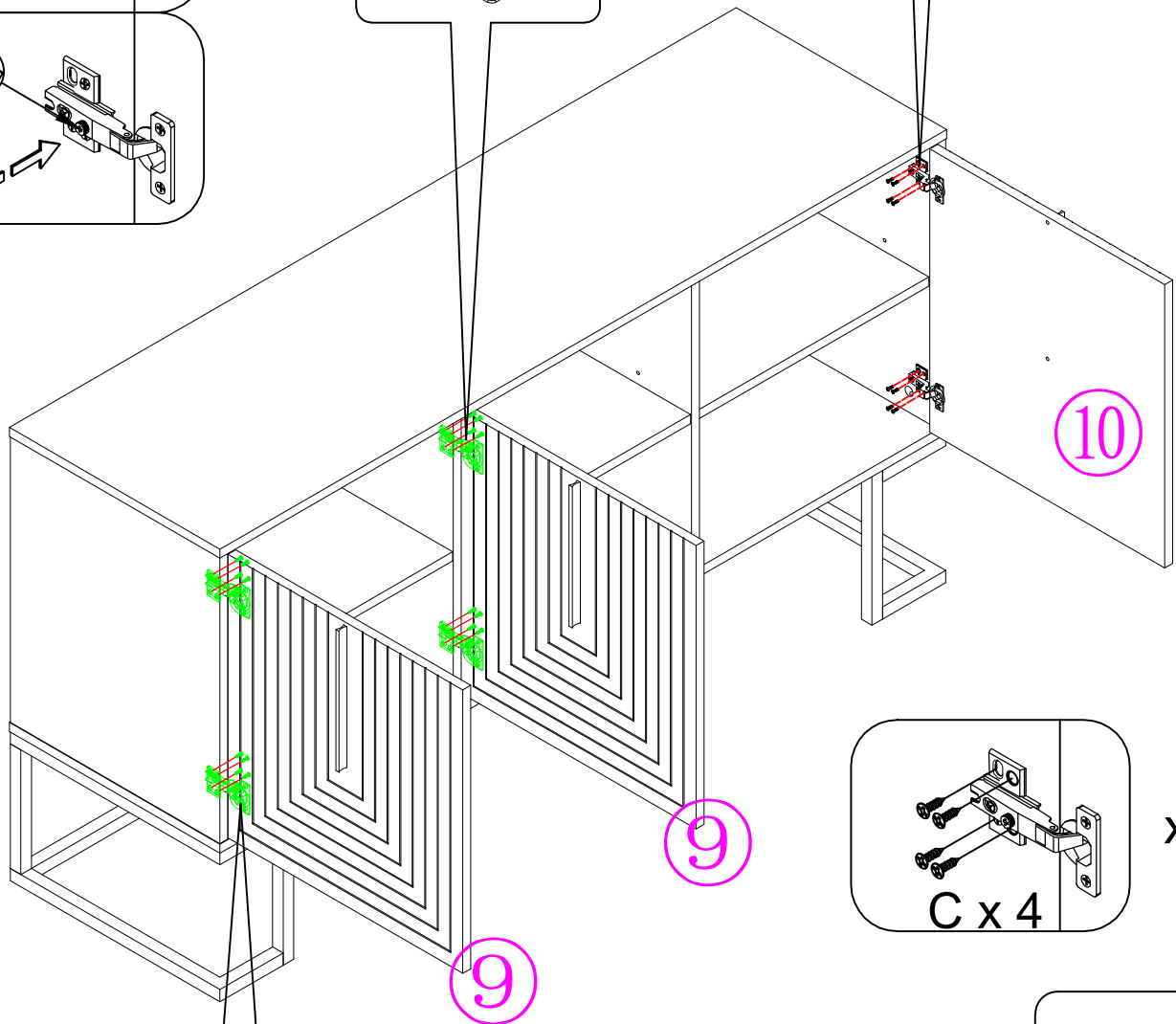
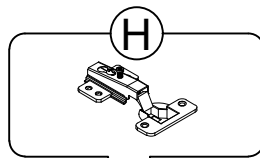
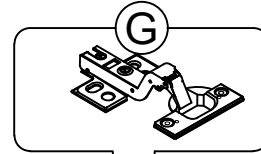
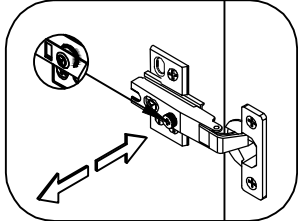
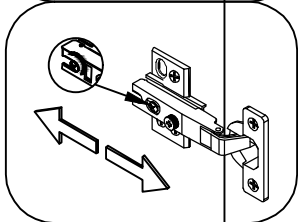
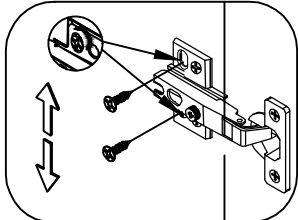

Assembly Instruction / Montageanleitung

ITEM:WF324457&WF324458

Step 16

UK: After installing the product, stick the number J on the perforated position

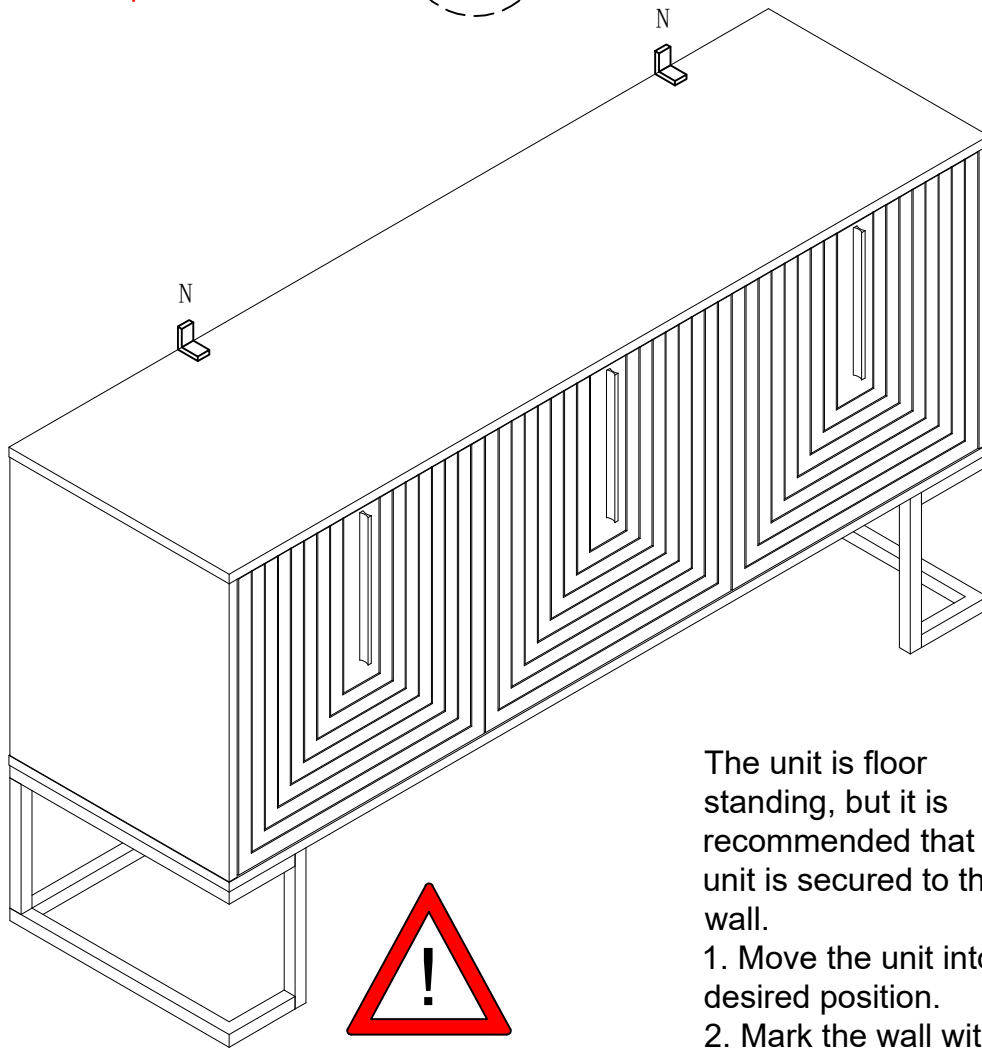
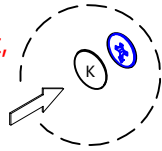

Warning:
Before drilling, check wall for hidden pipes and cables.

The unit is floor standing, but it is recommended that the unit is secured to the wall.

1. Move the unit into desired position.
2. Mark the wall with a suitable scribe the position of the fixing holes.
3. Drill holes and insert 2 x wall plug

