

<http://www.bega-gruppe.de>

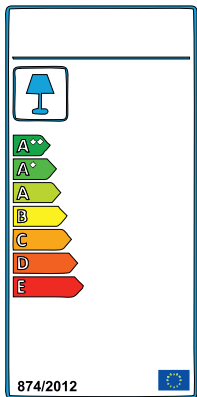

BG	Bulgarisch	български
CS	Tschechisch	čeština
DA	Dänisch	Dansk
DE	Deutsch	Deutsch
ET	Estnisch	Eesti
EL	Griechisch	ελληνικά
EN	Englisch	English
ES	Spanisch	español
FR	Französisch	Français
FI	Finnisch	suomalainen
HR	Kroatisch	hrvatski
HU	Ungarisch	magyar
IT	Italienisch	Italiano
LV	Lettisch	Latvijas
LT	Litauisch	Lietuvos
NL	Niederländisch	Nederlands
PL	Polnisch	Polski
PT	Portugiesisch	português
RO	Rumänisch	român
SK	Slowakisch	slovenský
SL	Slowenisch	slovenščina
SV	Schwedisch	Svenska

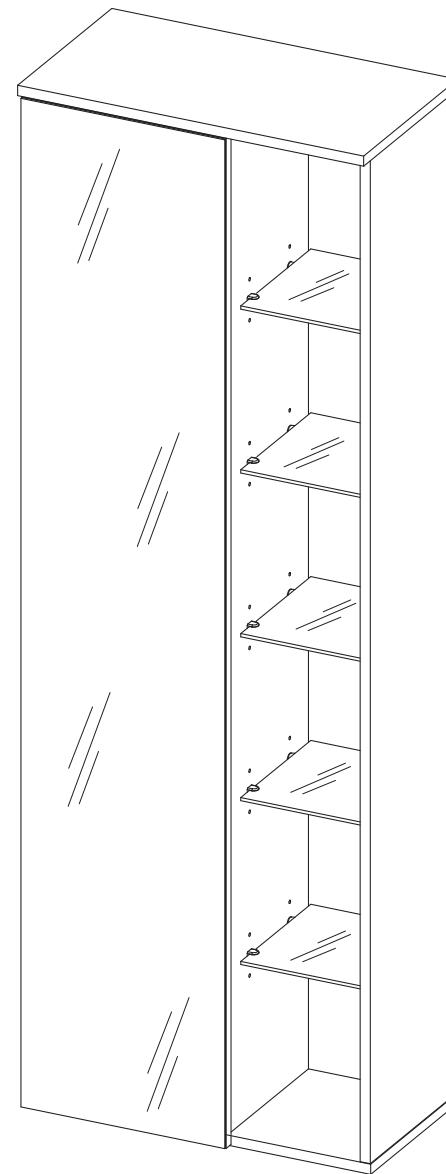

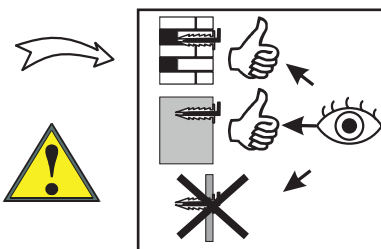
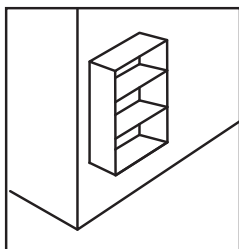
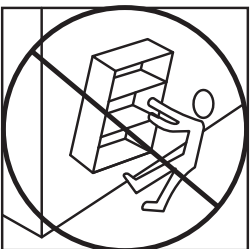
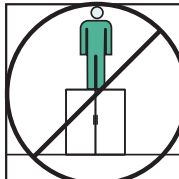
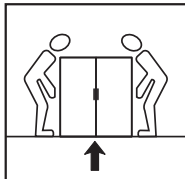
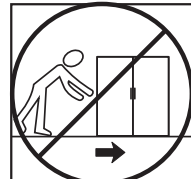
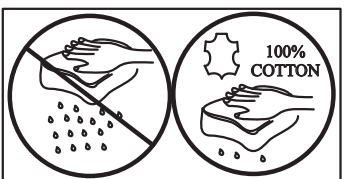
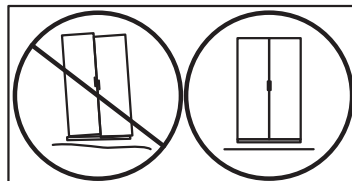
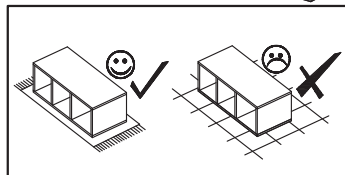
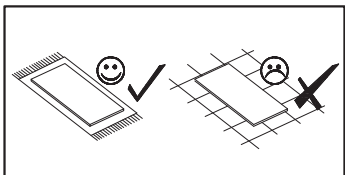
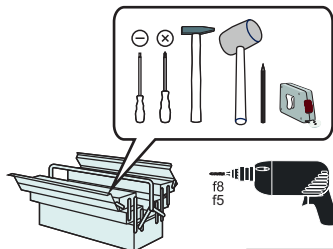
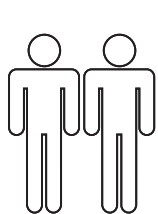
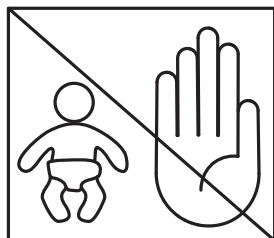
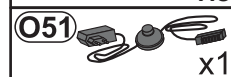
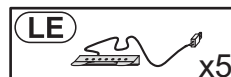
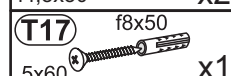
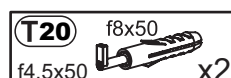
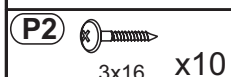
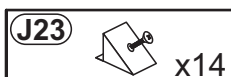
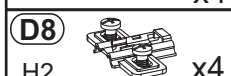
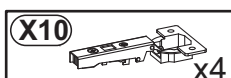
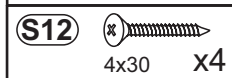
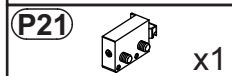
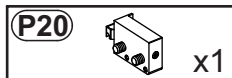
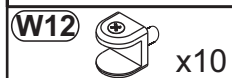
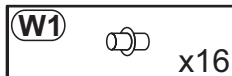
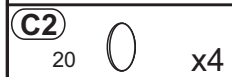
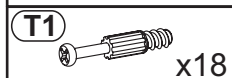
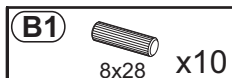

Nr	Ausmaß			St	Colli
1	1568	277	16	1	1
2	1568	257	16	1	1
3	1568	277	16	1	1
4	552	300	16	1	2
5	291	248	16	4	2
6	204	223	5	5	2
7	291	257	16	1	2
8	552	278	16	1	2
9	1578	326	19	1	1
10	518	80	16	1	2
11	1582	532	2	1	2

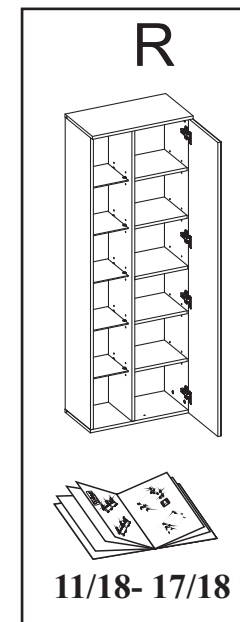
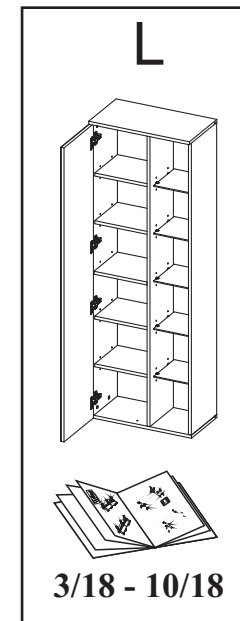
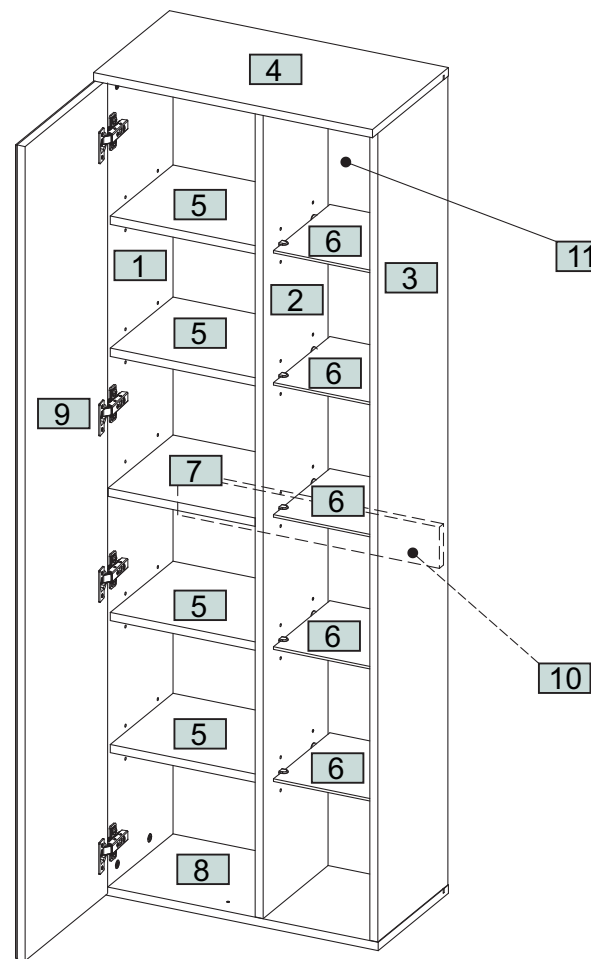
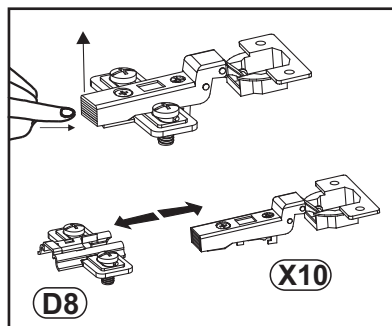



0 10 20 30 40 50 60 70 80 90 100 110 120 130 140 150 160 170 180 190 200



1

B1  $\varnothing 8 \times 28$ x8

T1  x4

P20  x1

D8  H2 x4

C2  20 x8

P21  x1

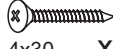
S12  4x30 x4

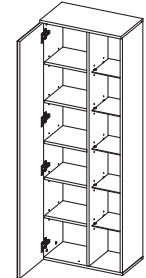
L 

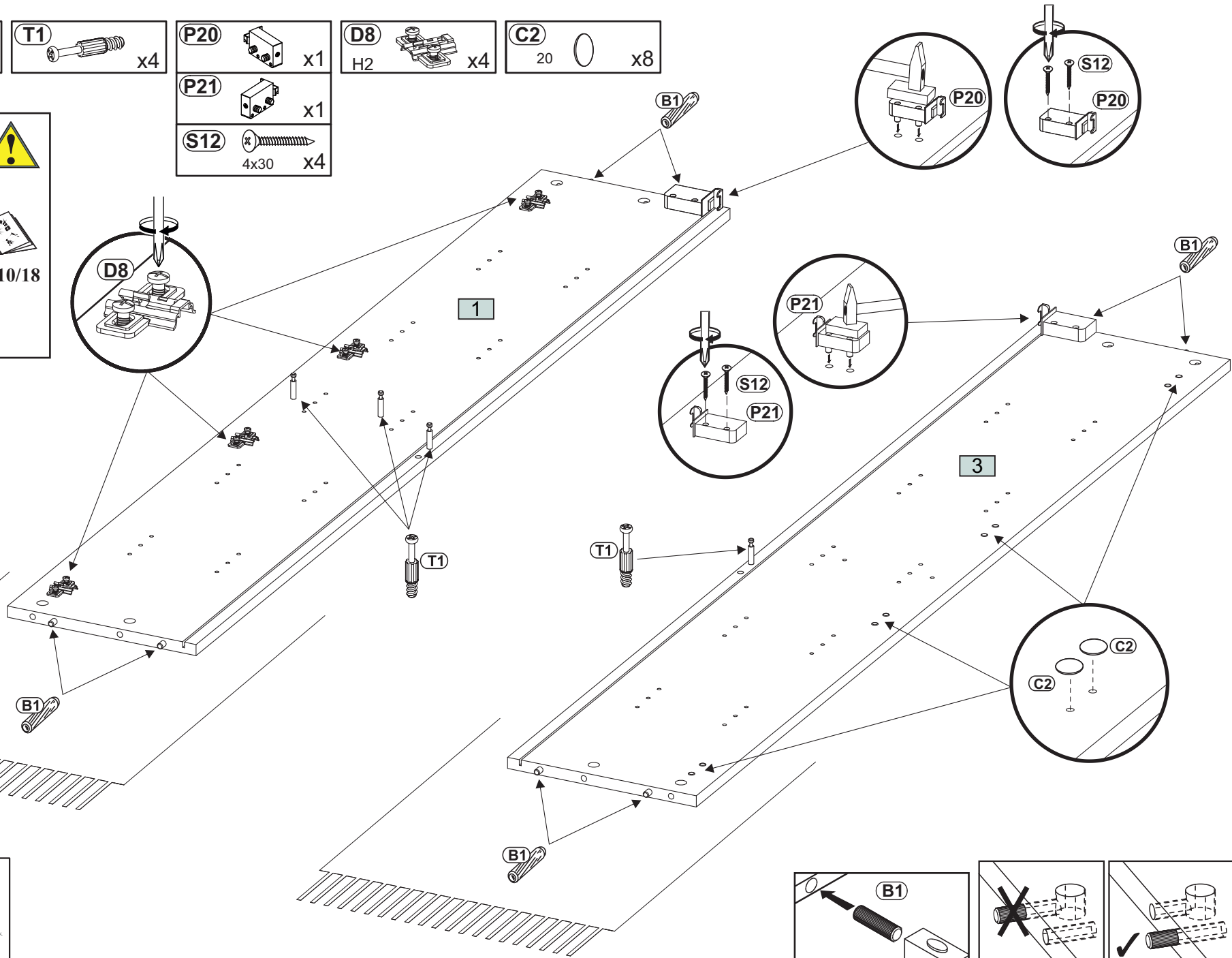
3/18 - 10/18

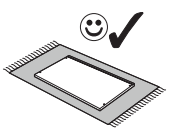
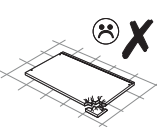

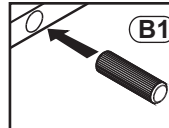

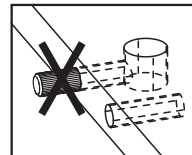
 **B1**

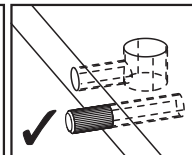



2

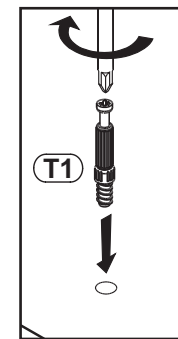
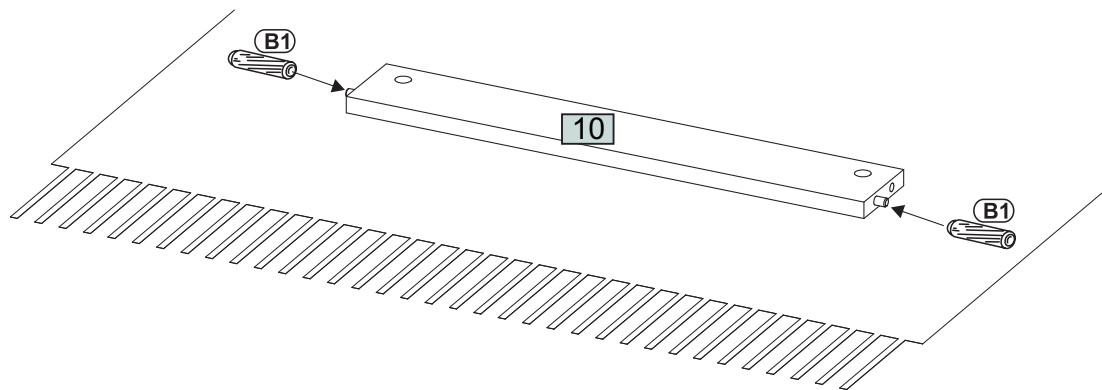
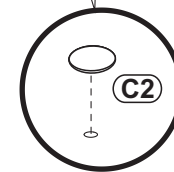
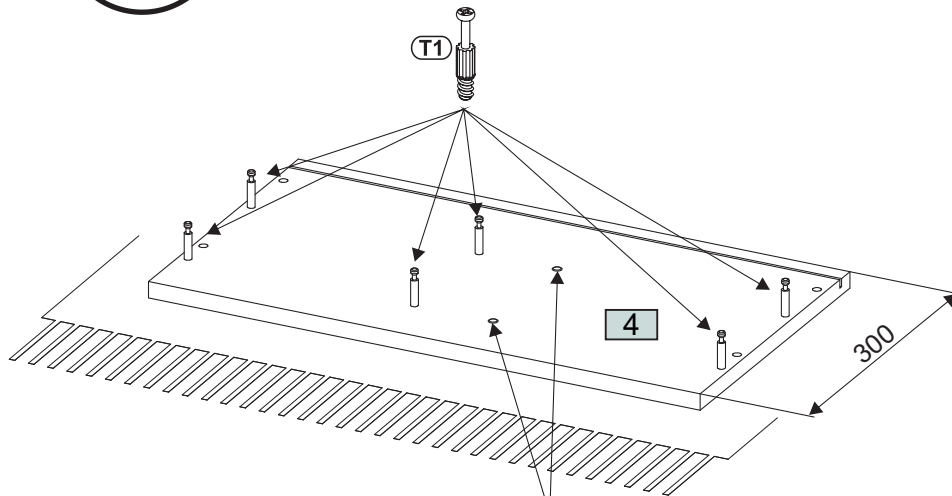
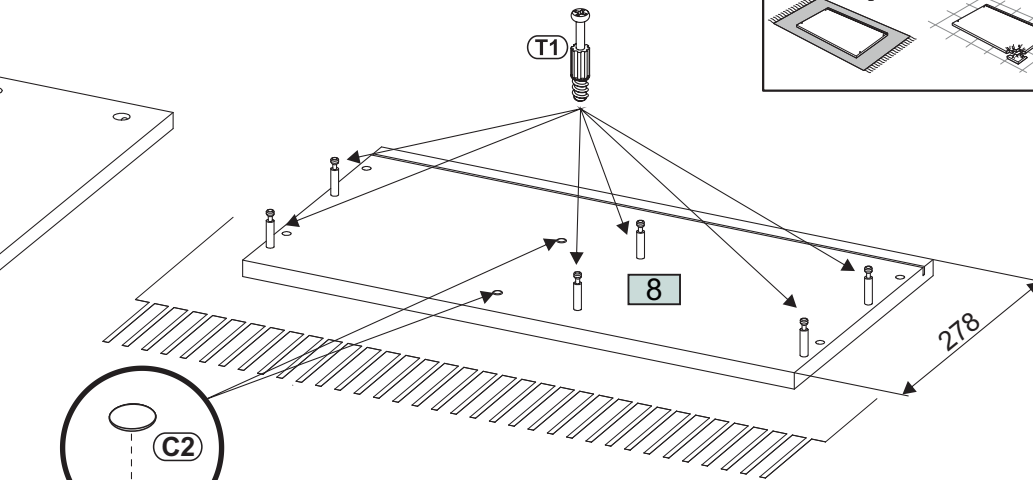
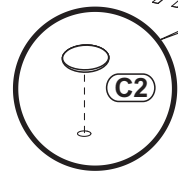
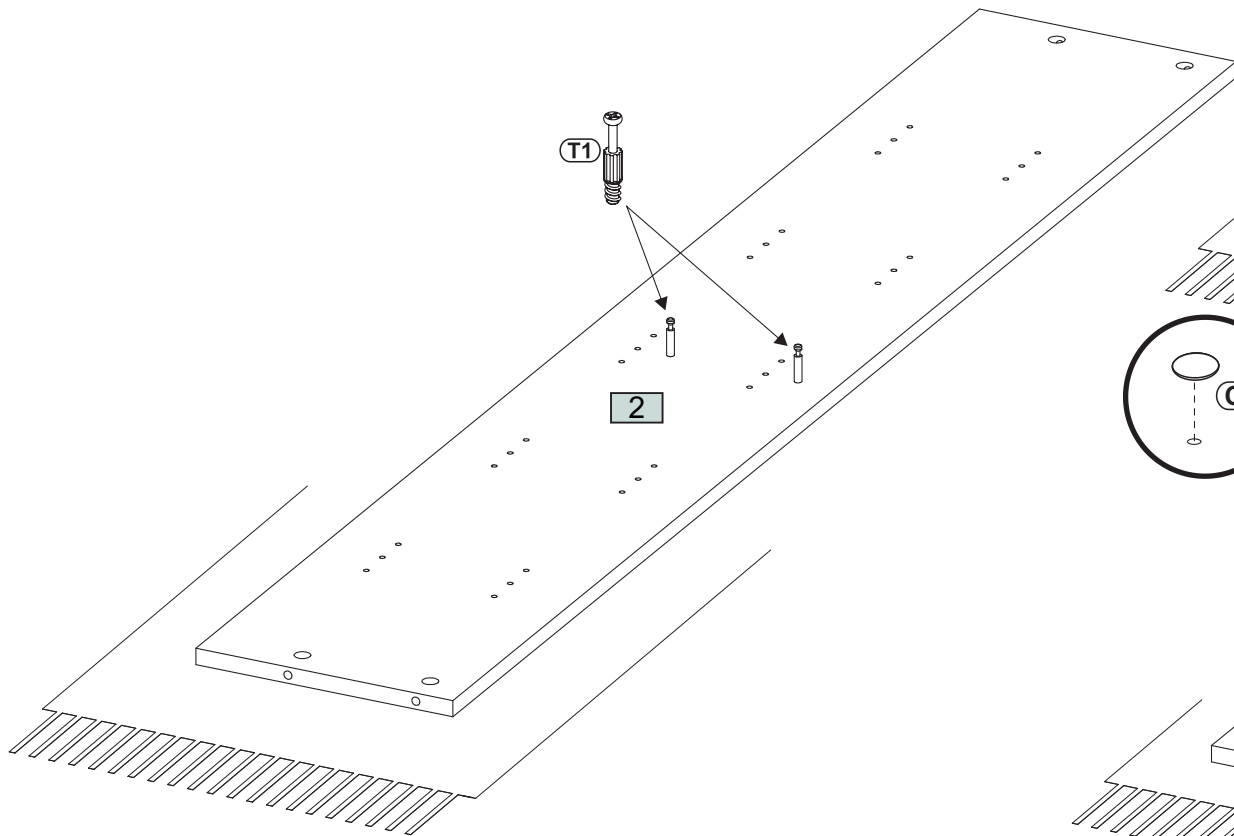
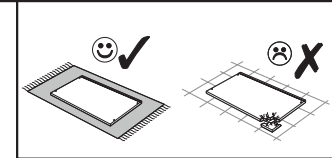
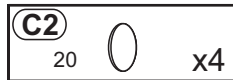
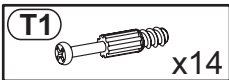
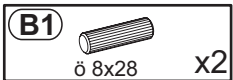

3

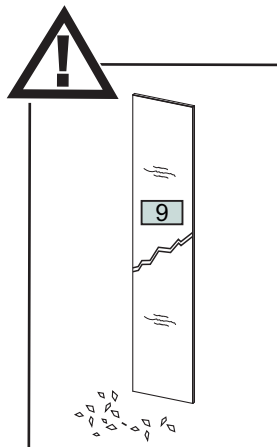
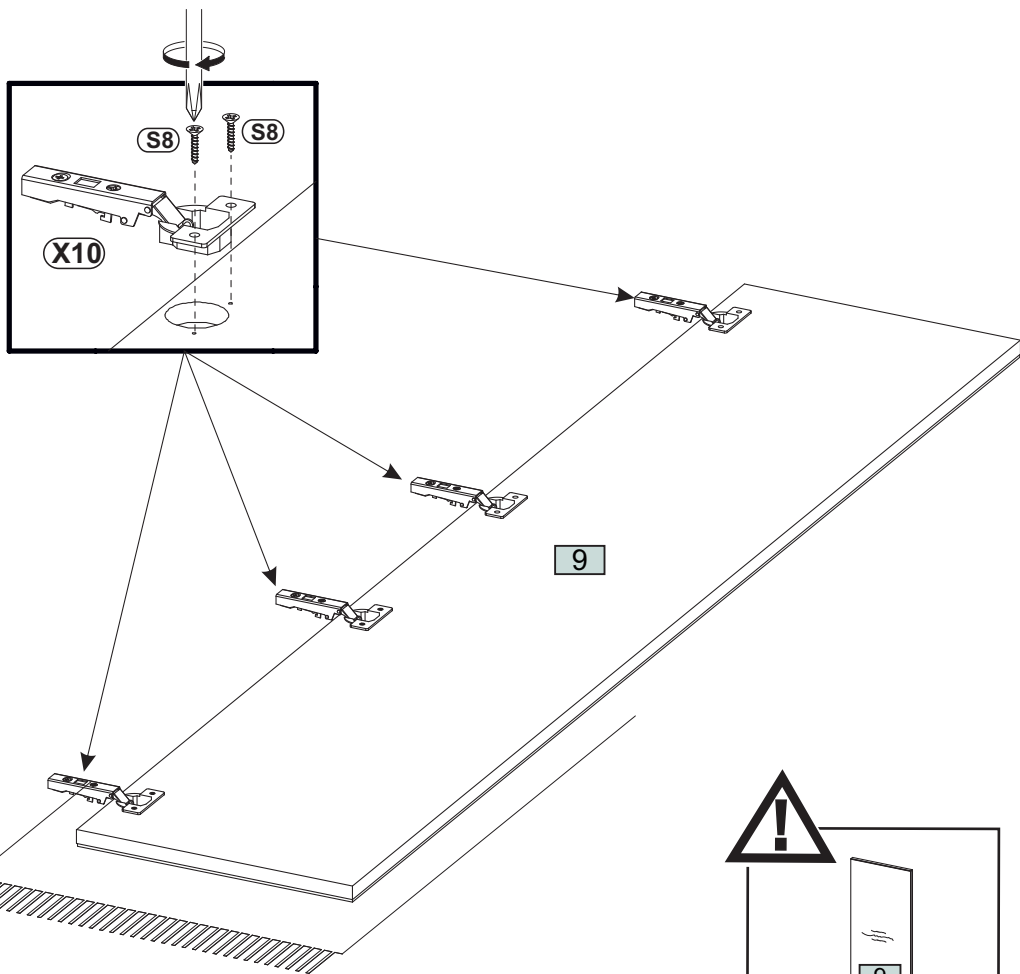
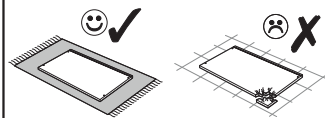

4

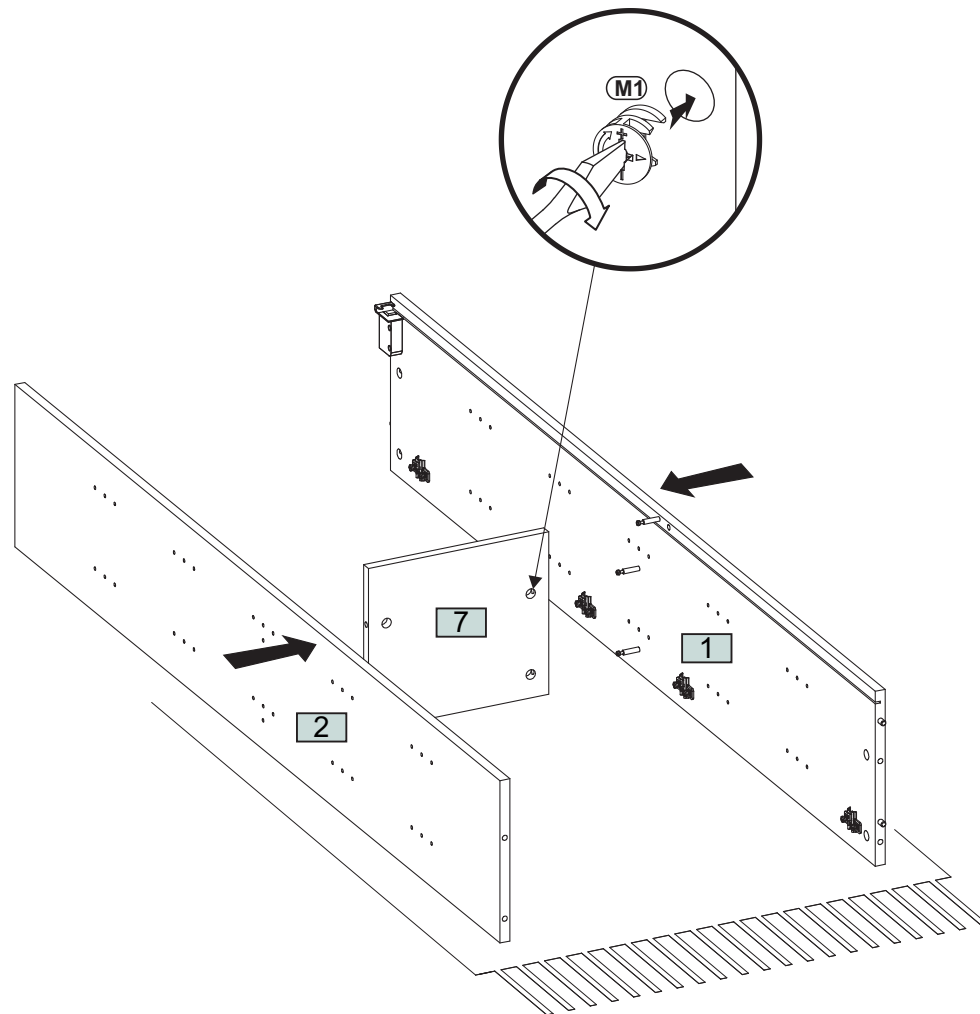
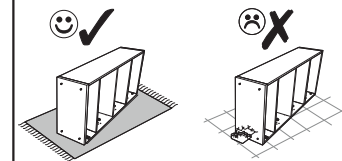

5

M1  x2

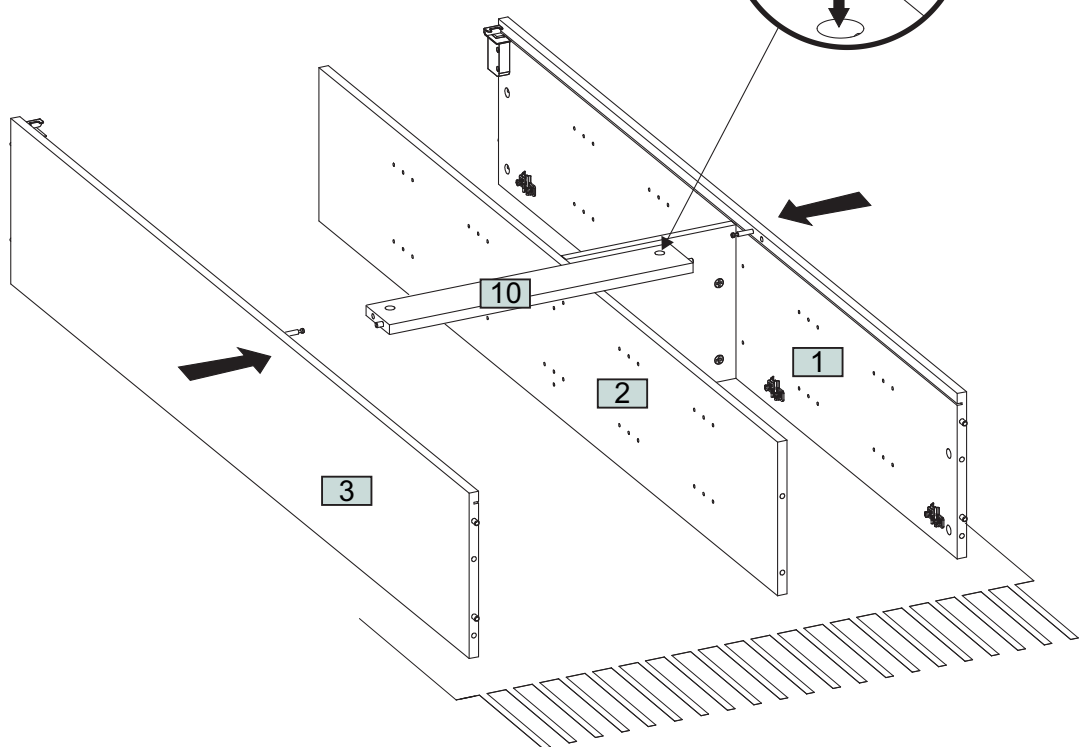
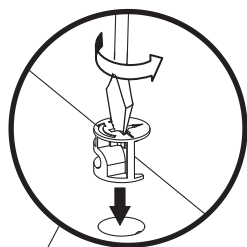
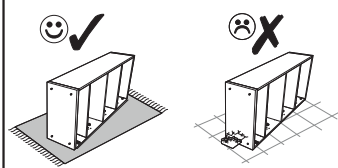

6

M1  x6

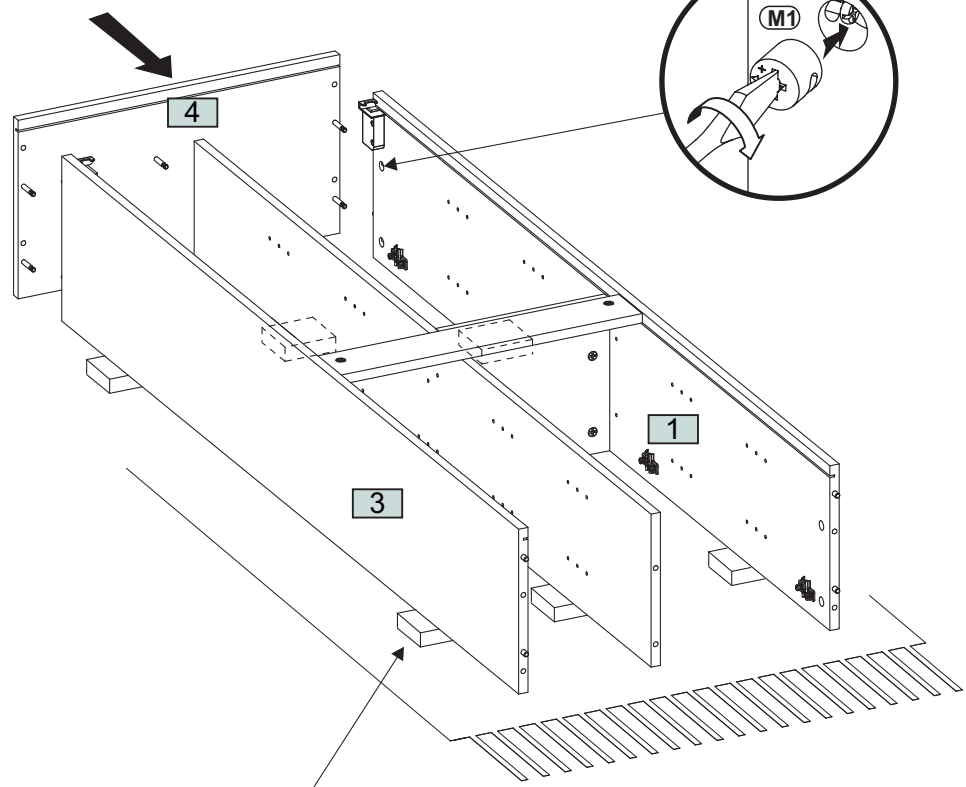
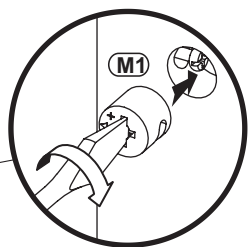
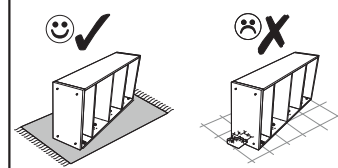

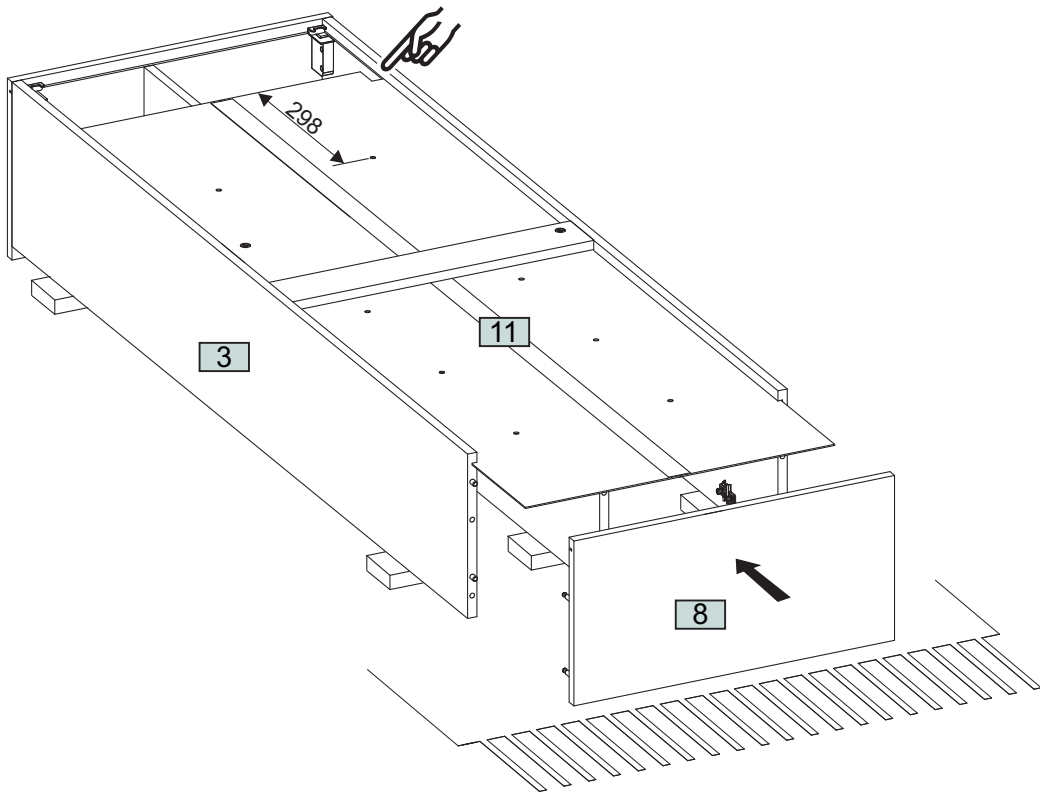
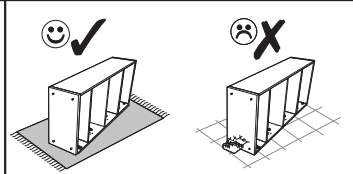

7

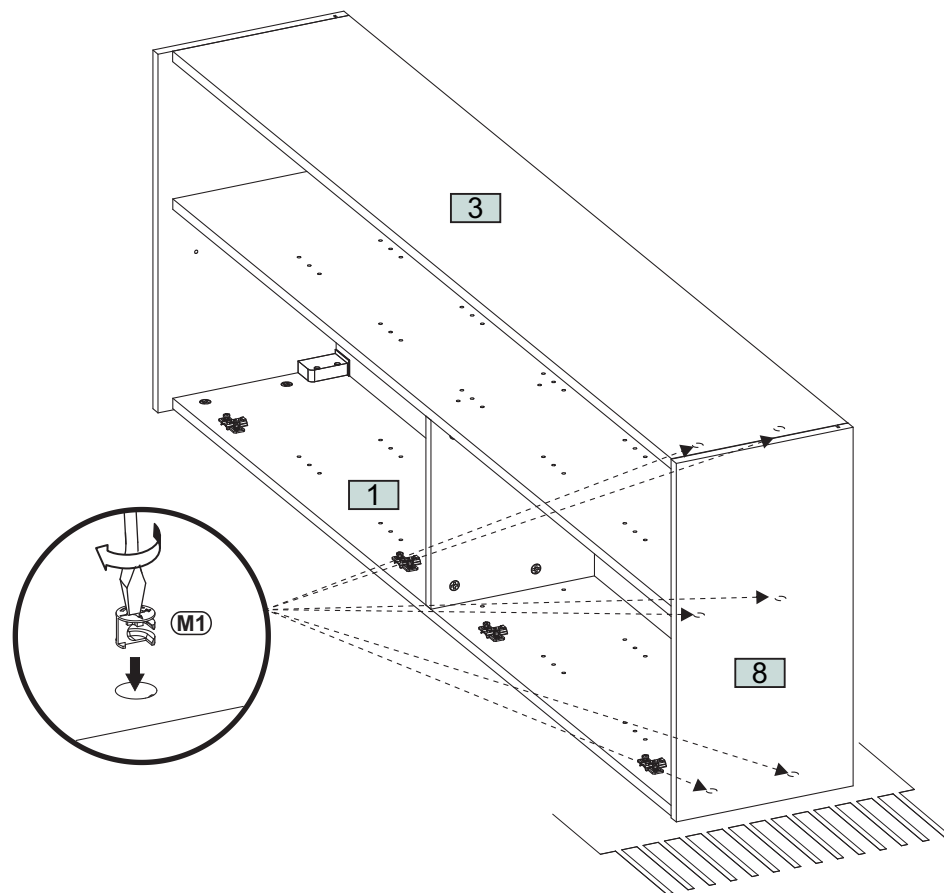
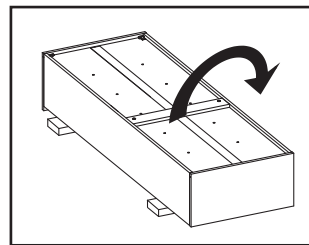
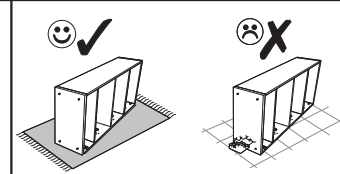

8



9

- J23  x14
- P2  3x16 x10

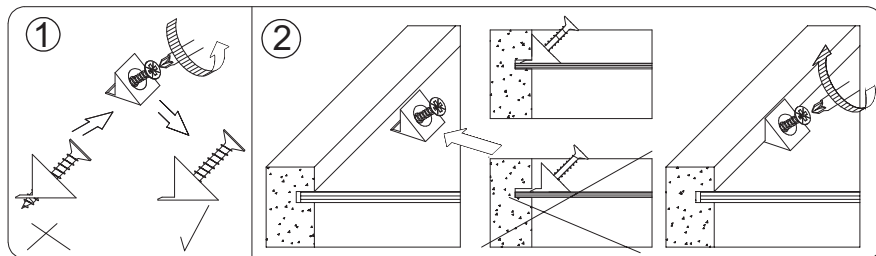
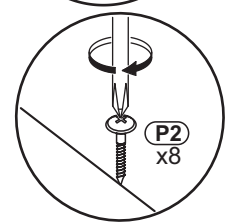
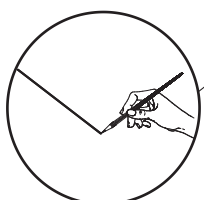
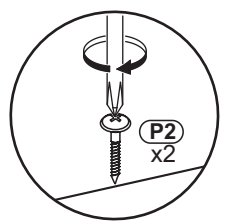
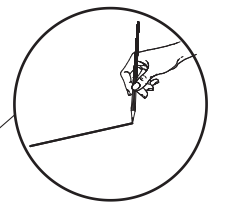
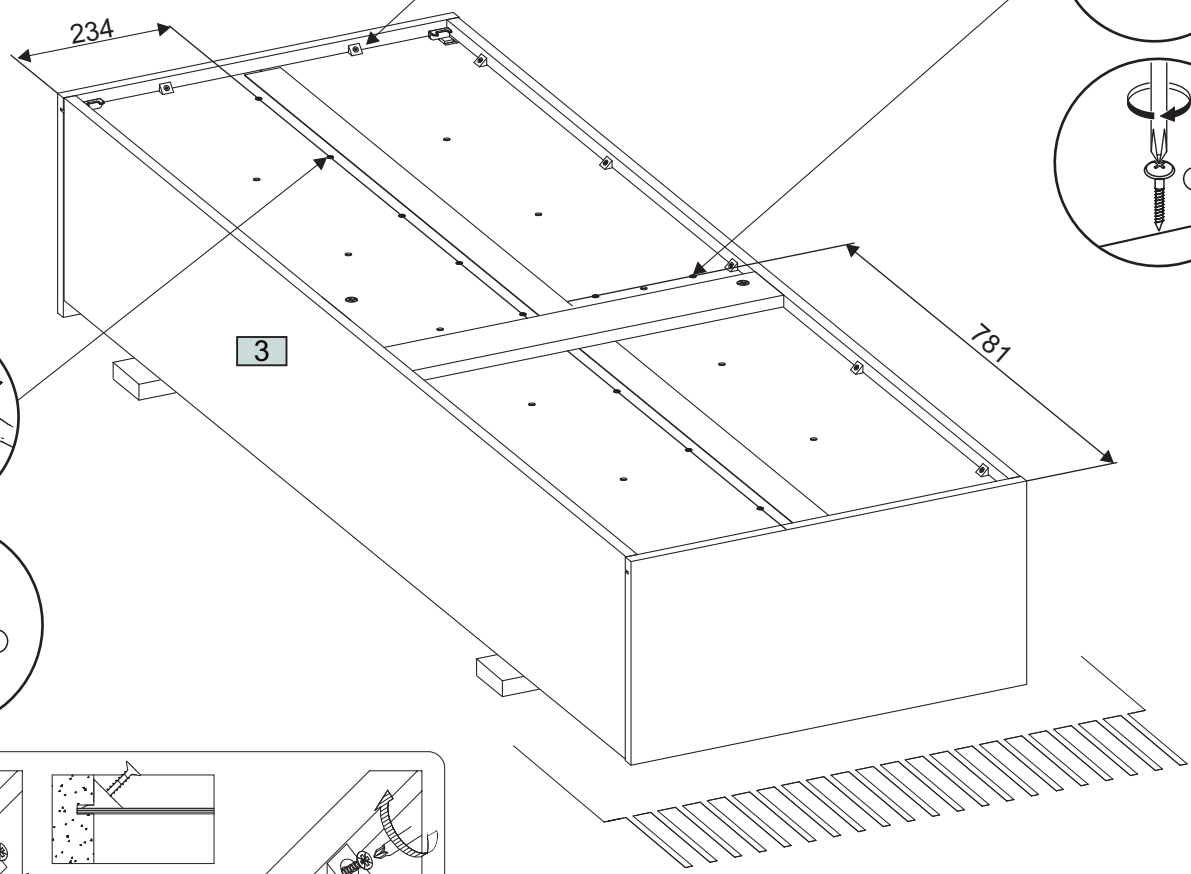
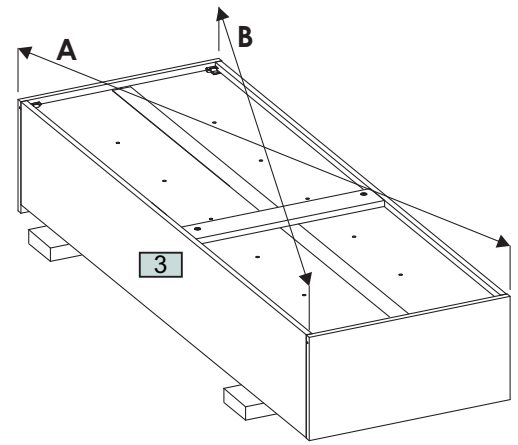
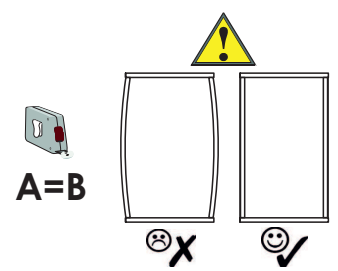
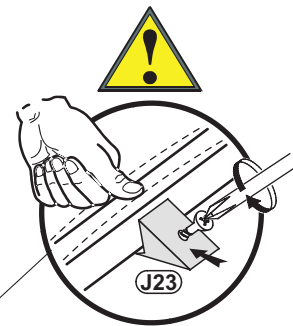
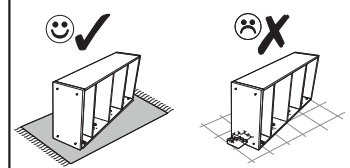

10

- T10** f8x50 x2
- T17** f8x50 5x60 x1
- C2** 20 x18
- C2** 20 x4

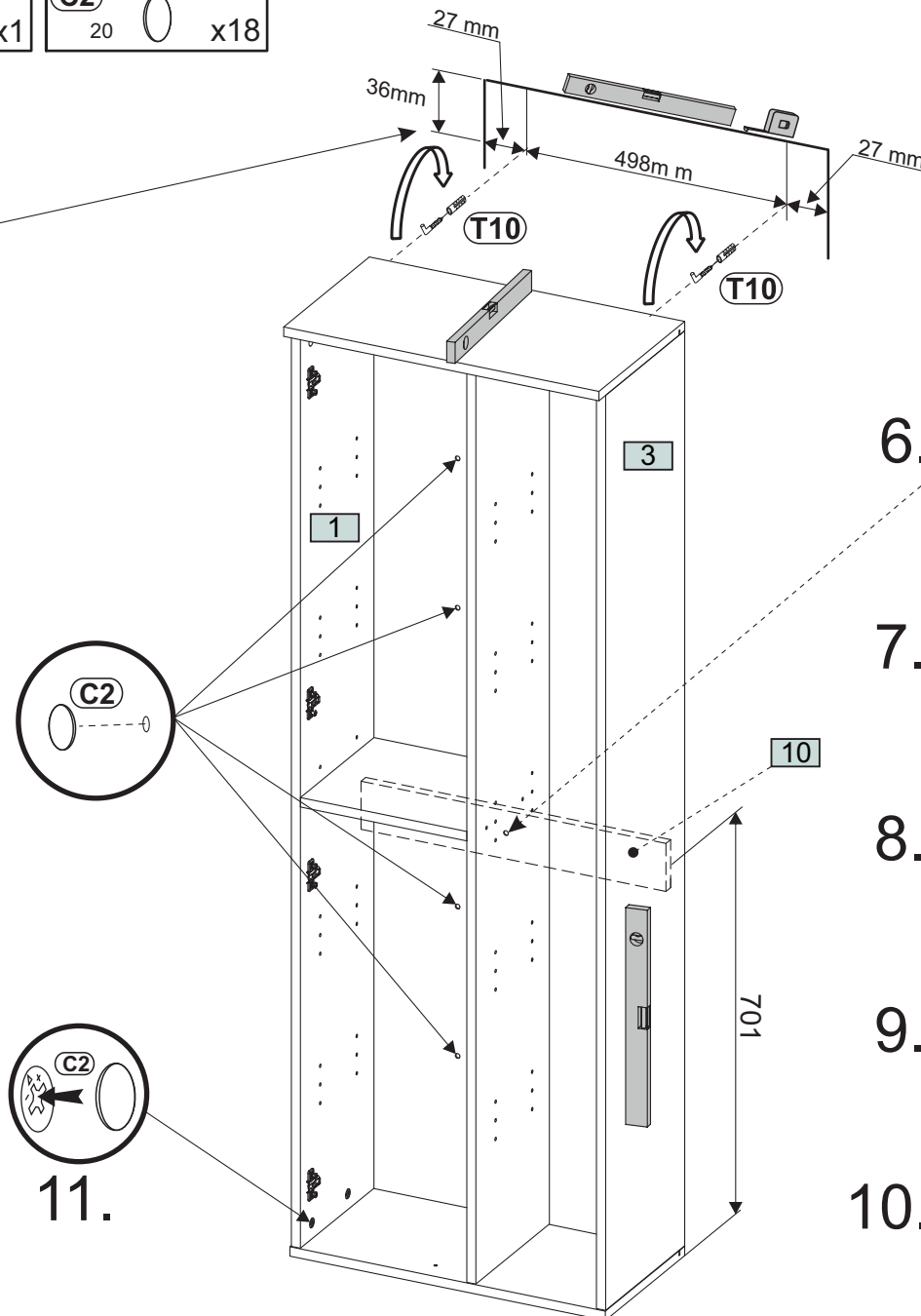

-
-
-
-
-



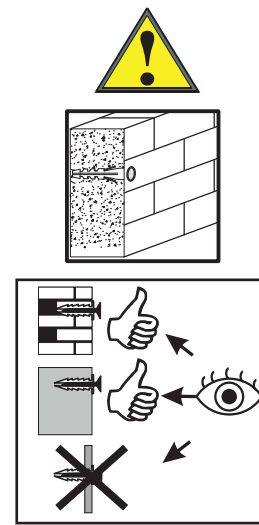

-
-
-
-
-



11

- W1**  x16
- W12**  x10
- W13**  x10

- LE**  x5
- O51**  x1

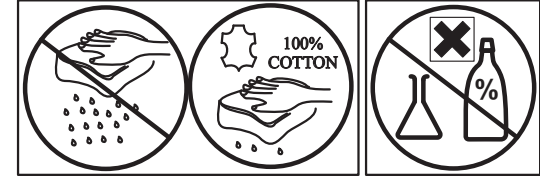
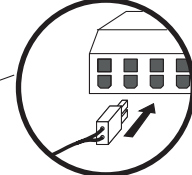
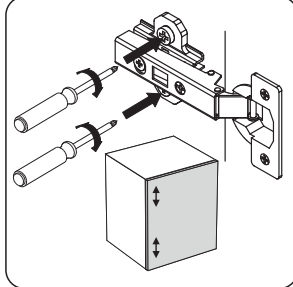
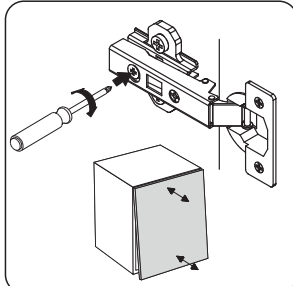
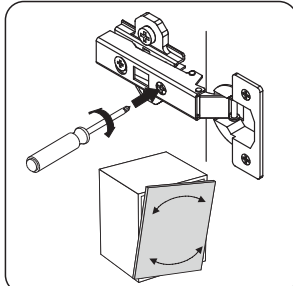
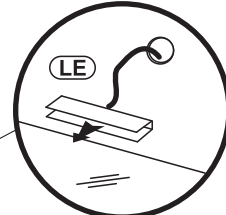
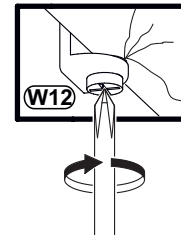
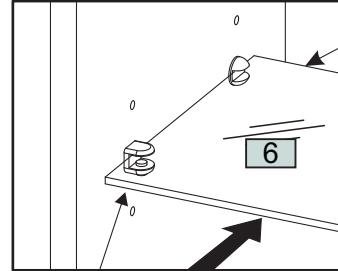
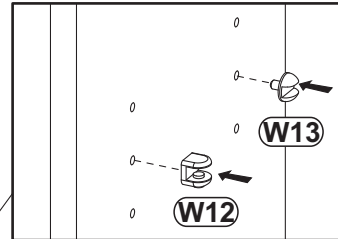
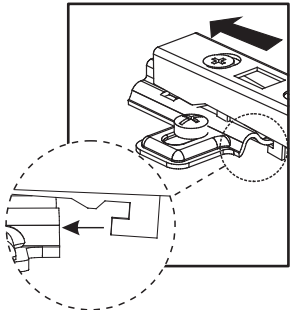
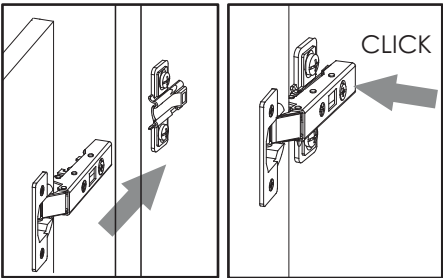
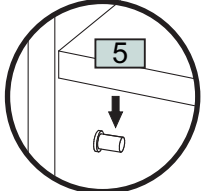
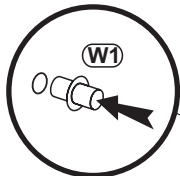
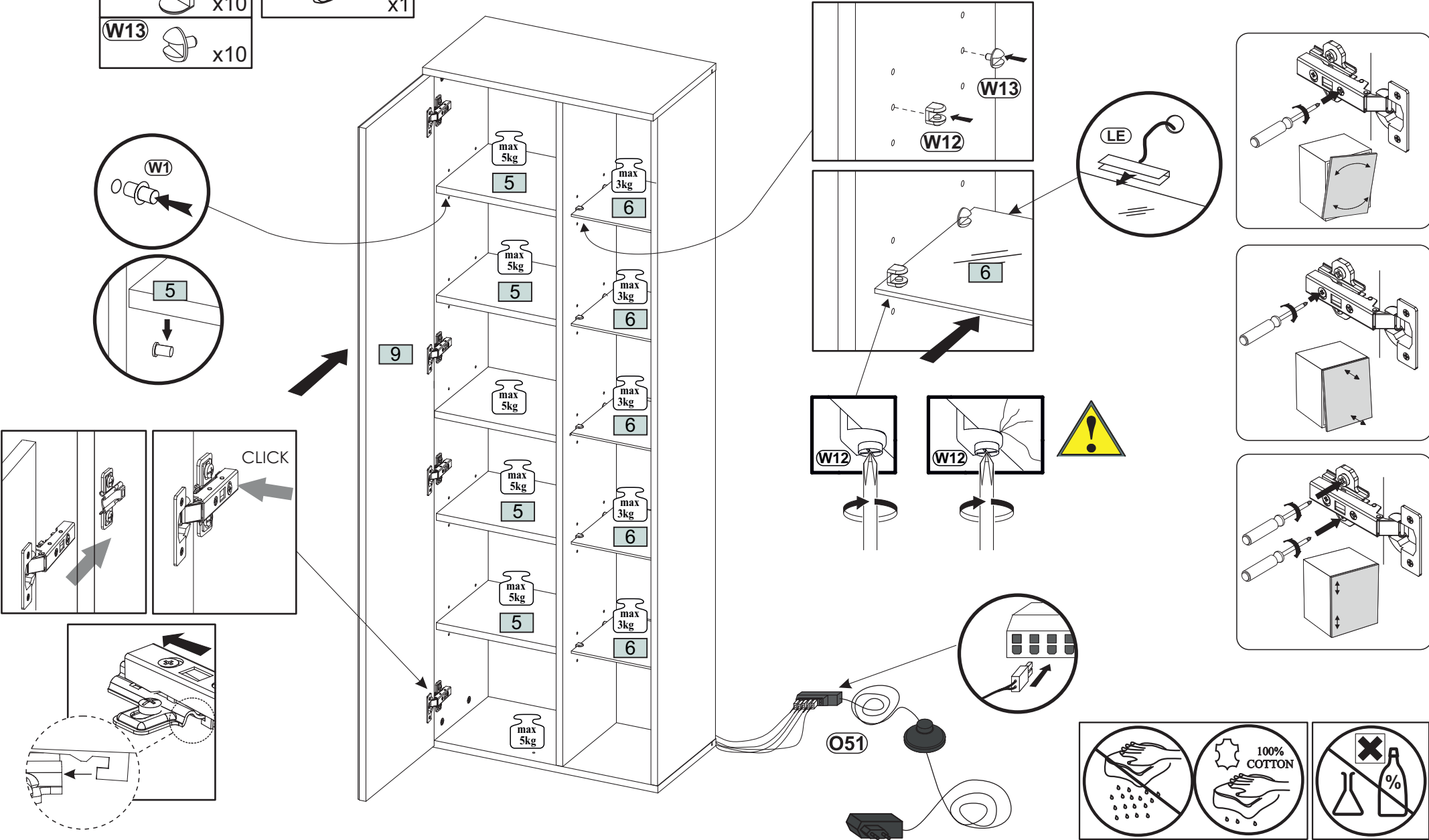

1

B1  $\varnothing 8 \times 28$ x8

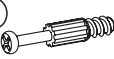
T1  x4

P20  x1

D8  H2 x4

C2  20 x8

P21  x1

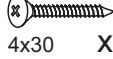
S12  4x30 x4

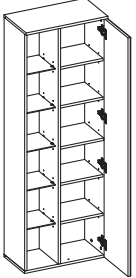
R  
 11/18 - 18/18

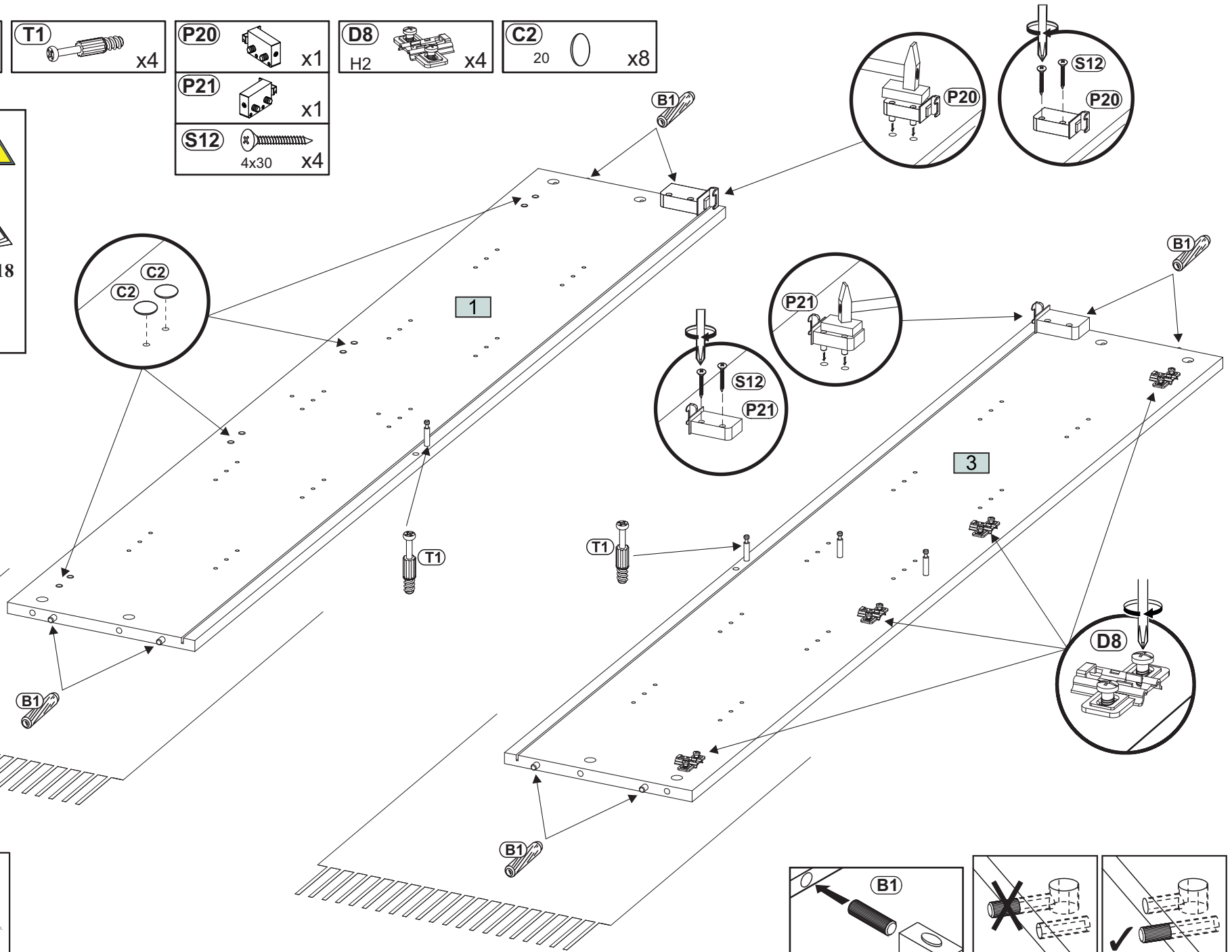

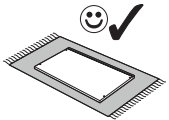
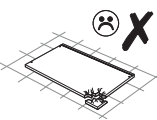

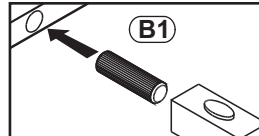
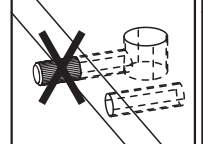
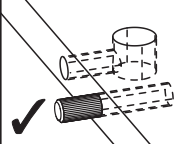
2

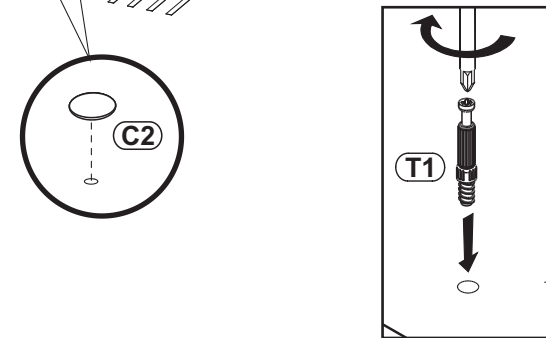
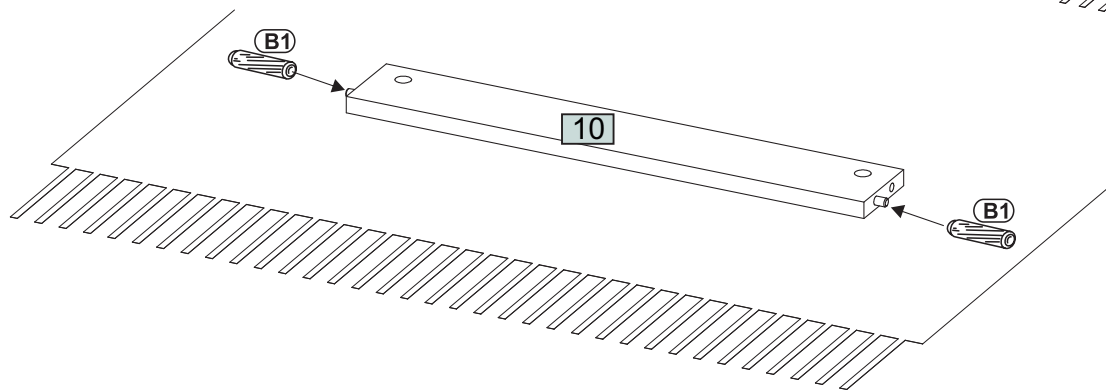
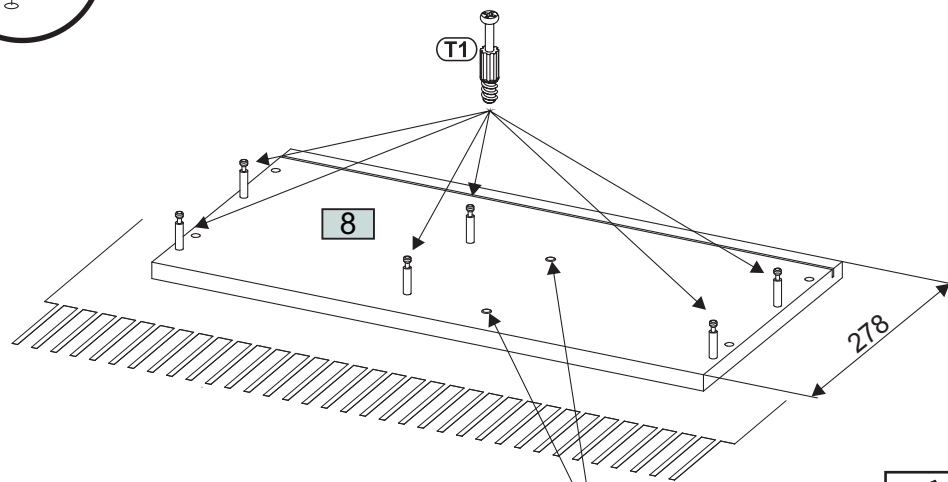
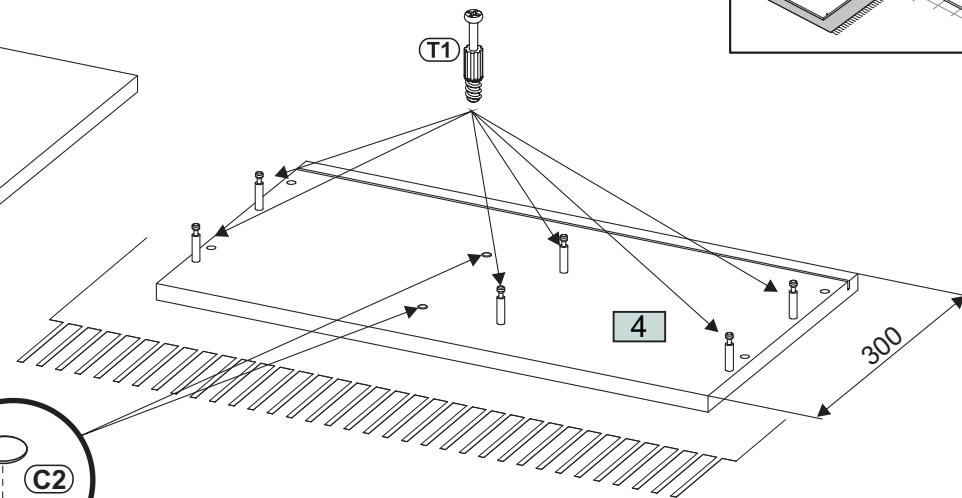
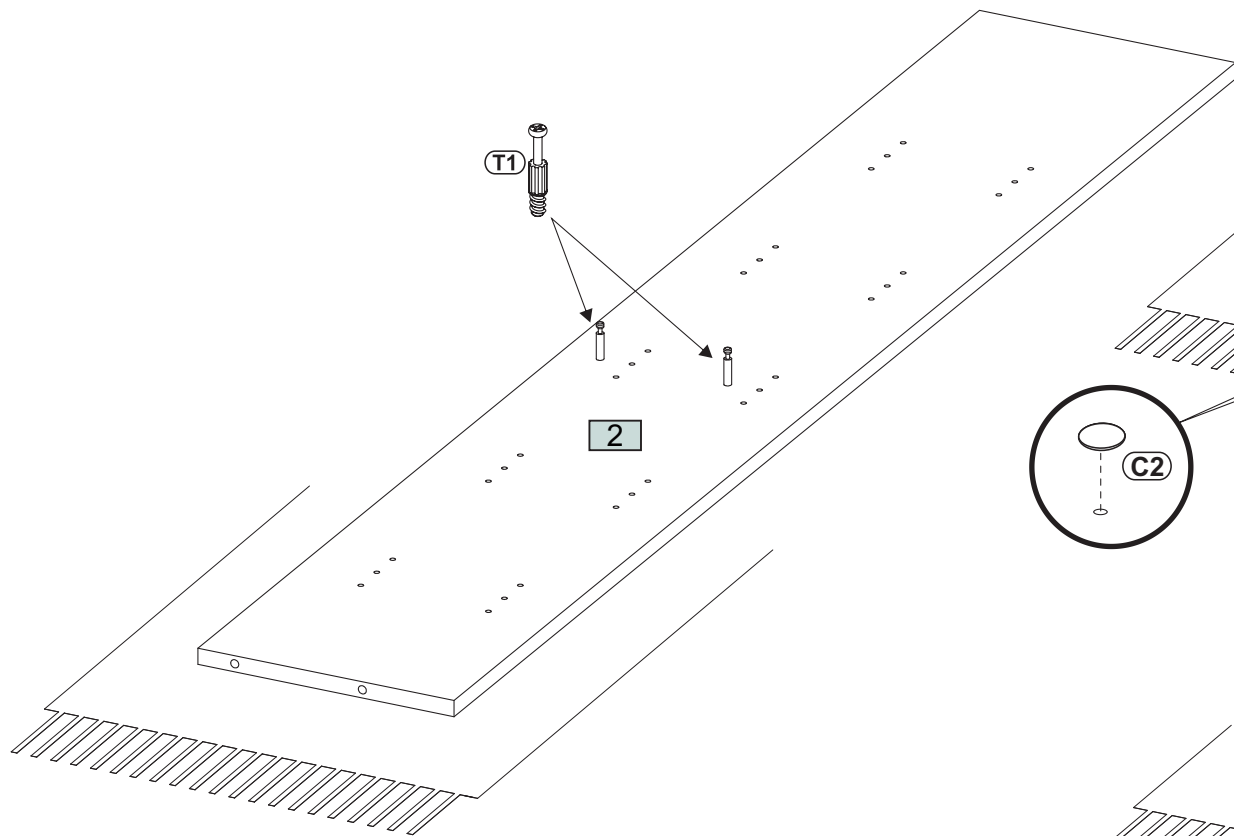
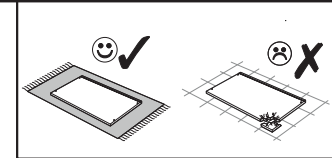
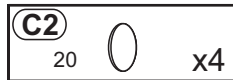
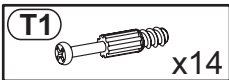
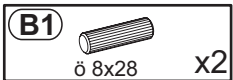

3

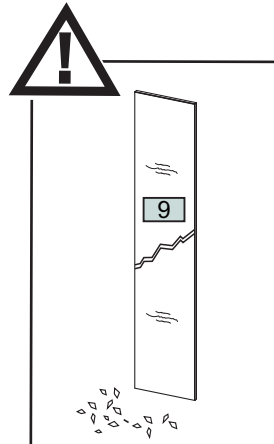
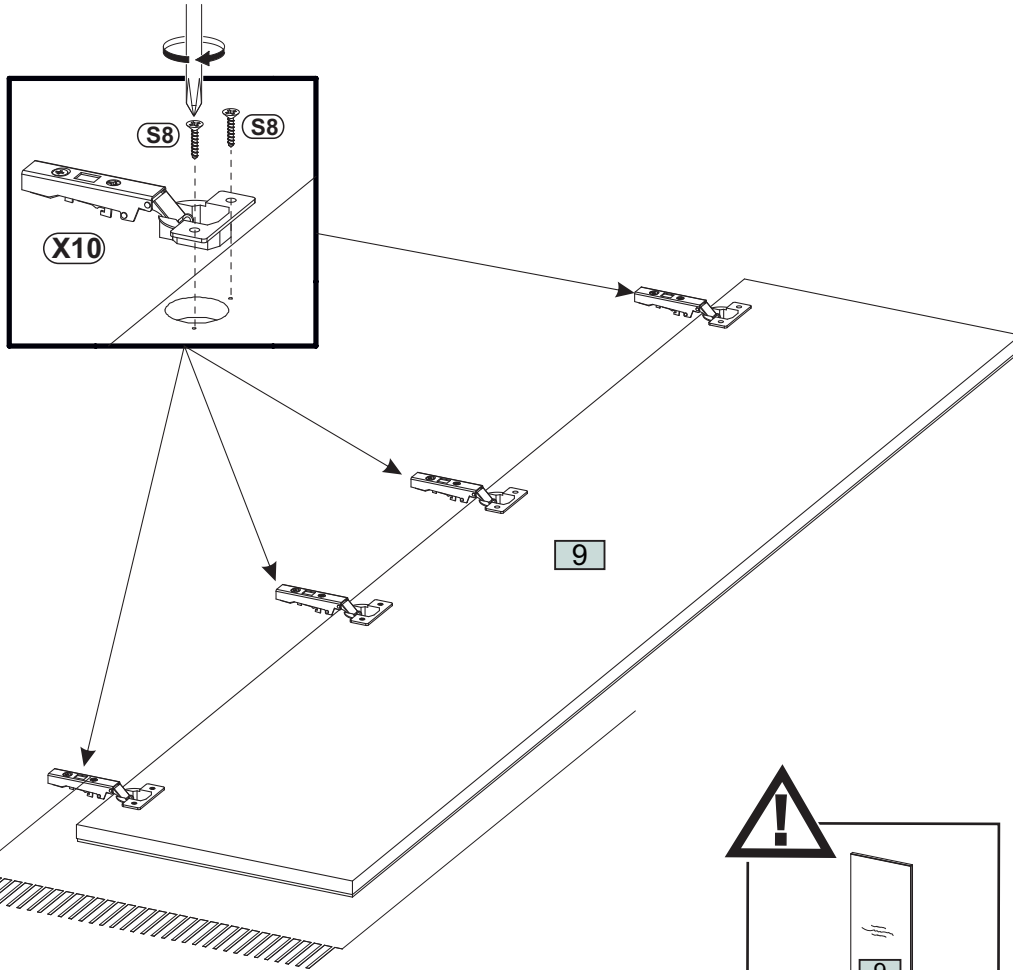
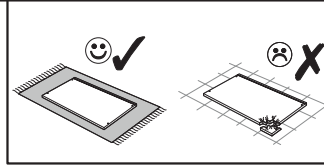
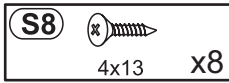
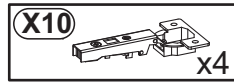

4

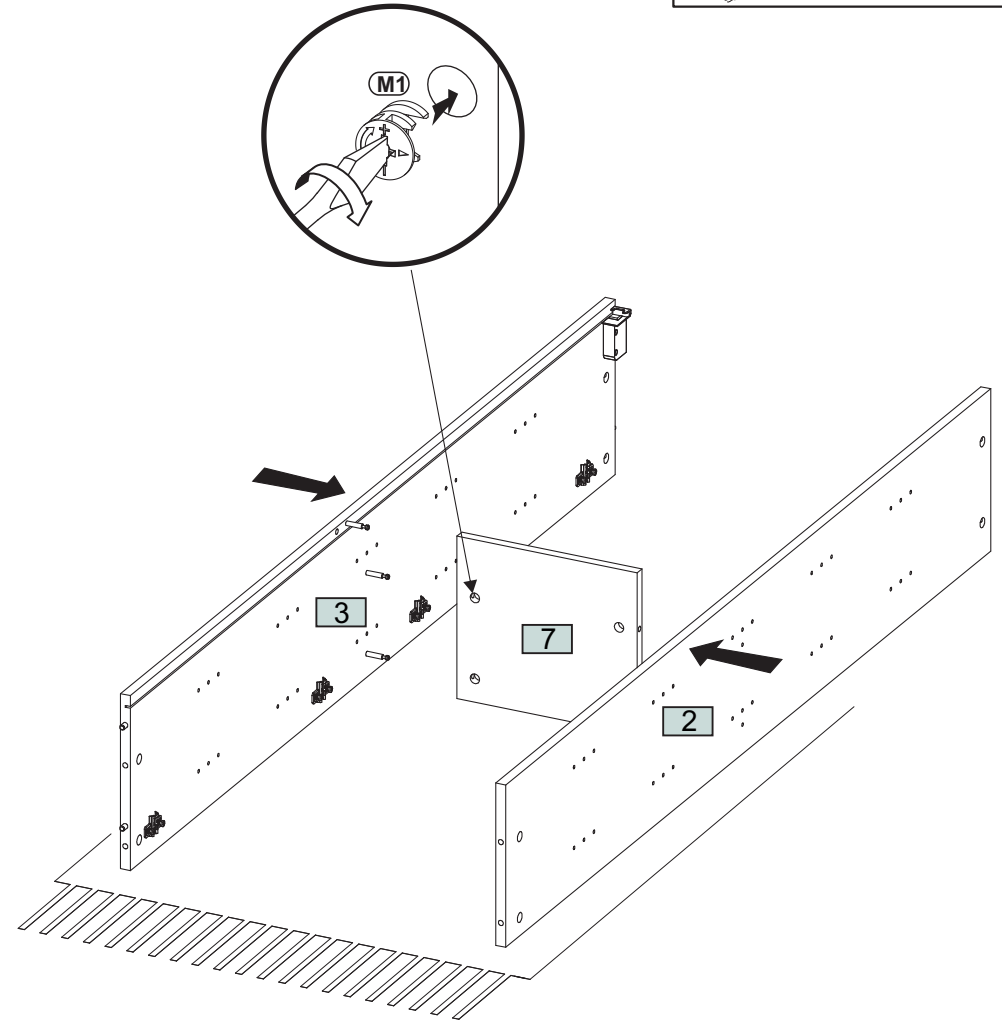
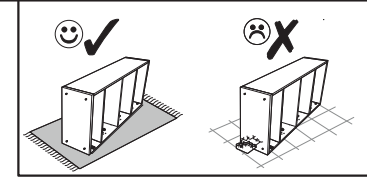

5

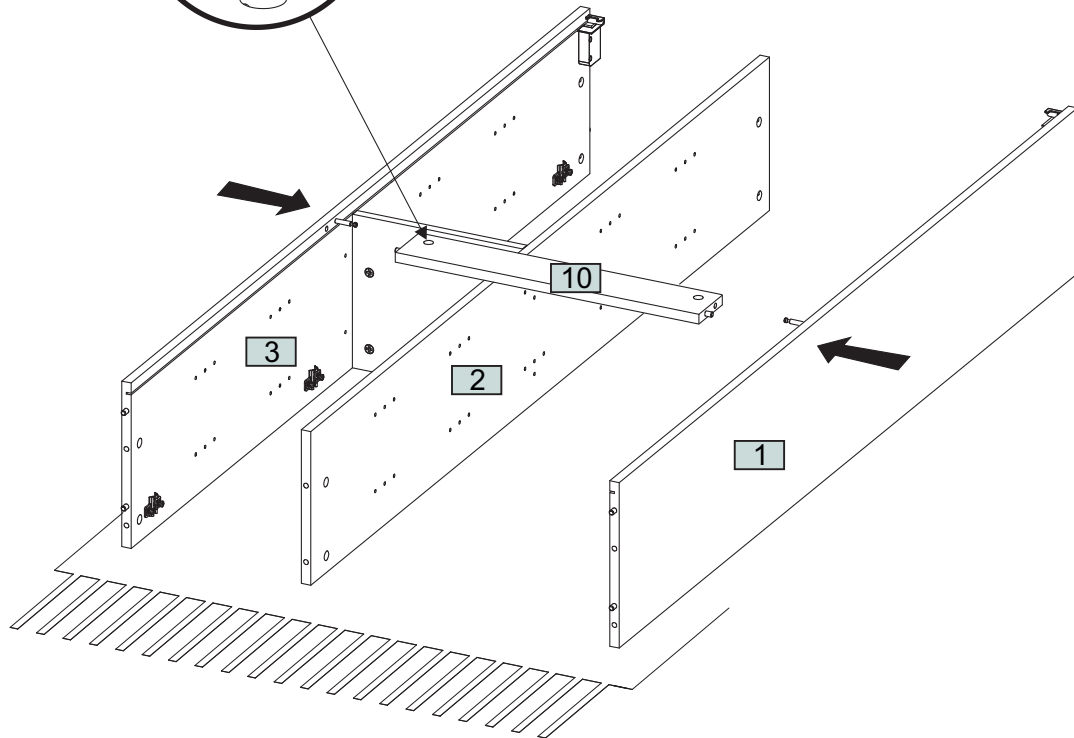
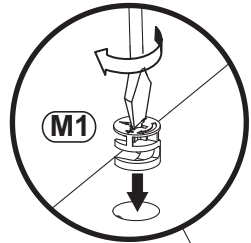
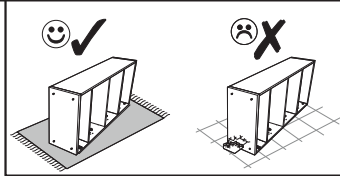

6

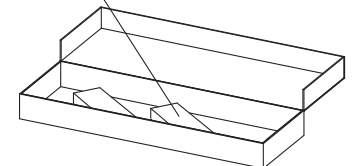
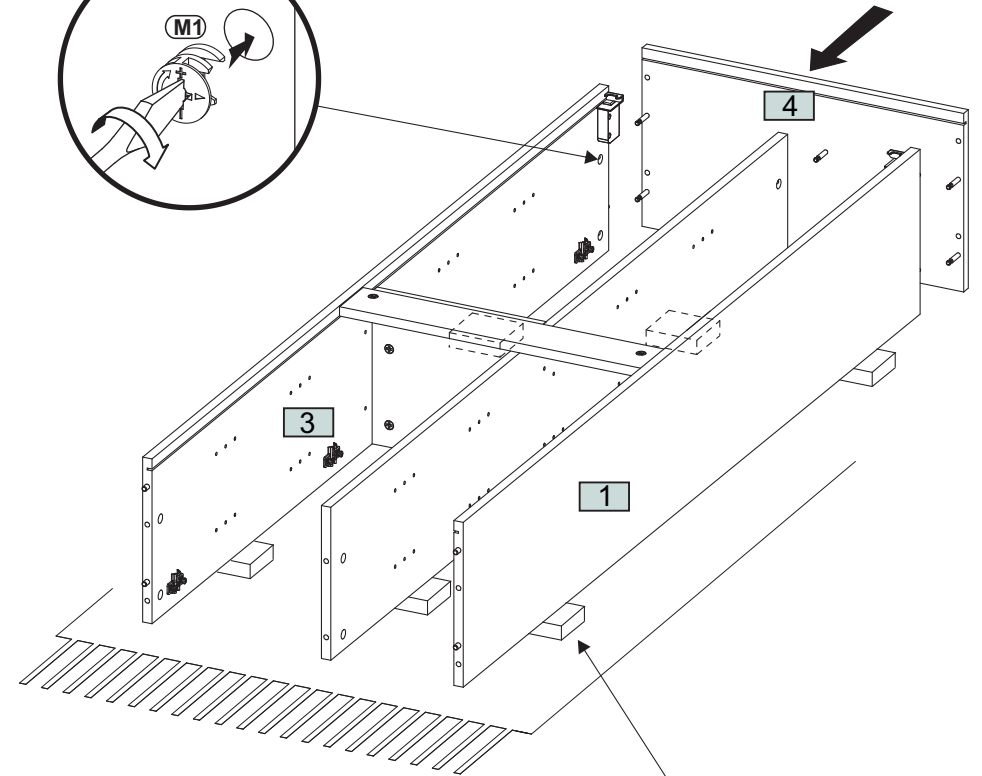
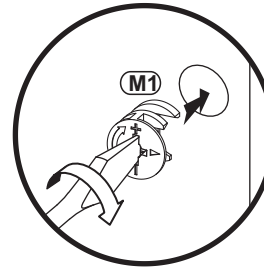
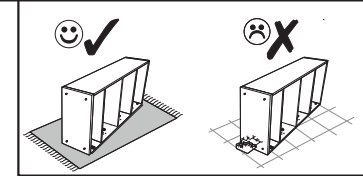

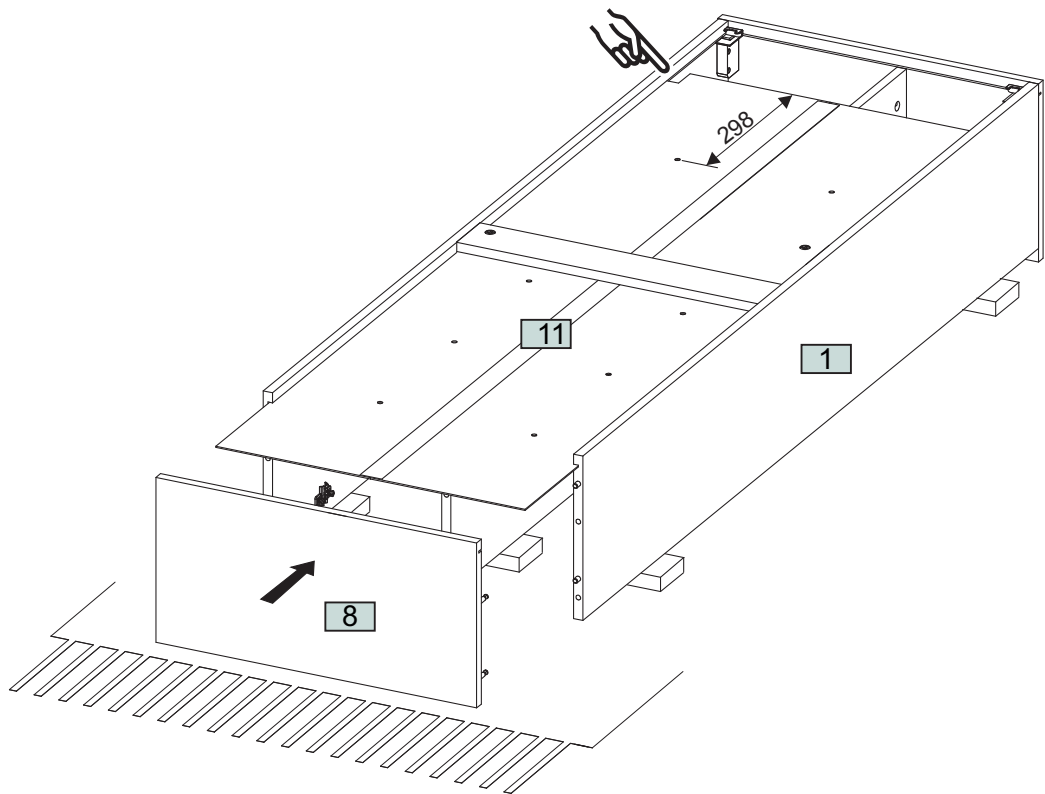
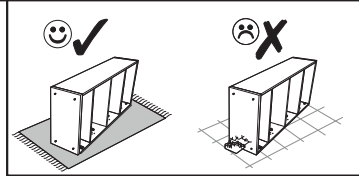

7



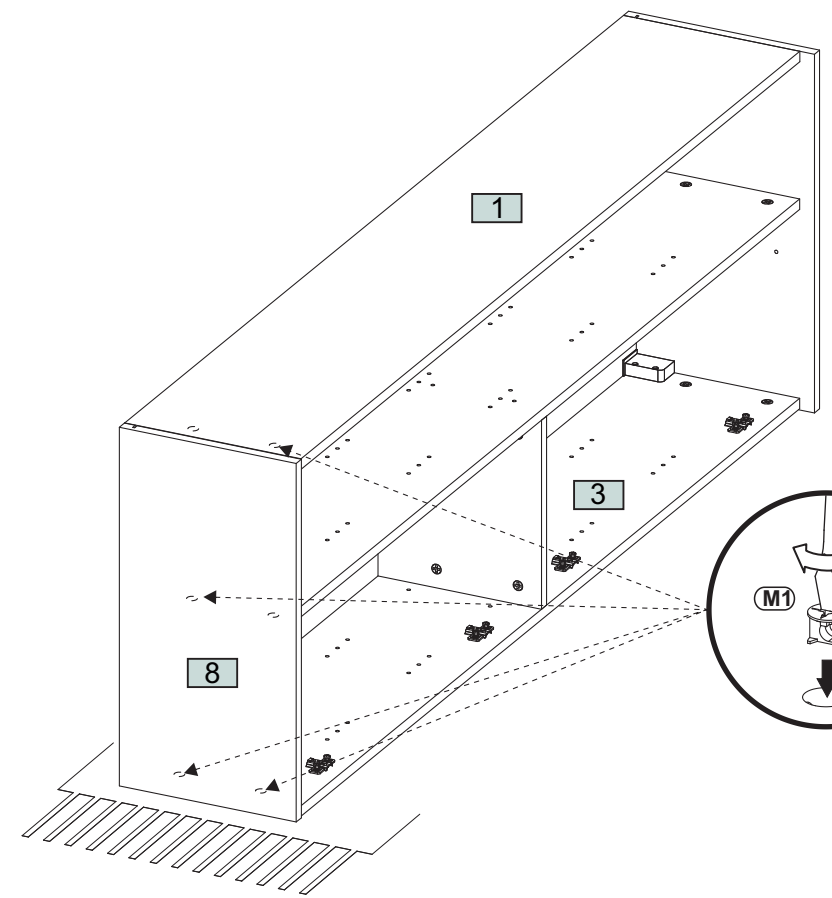
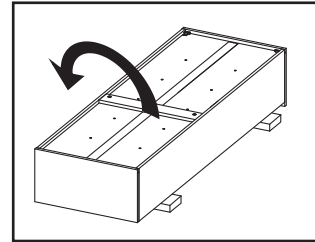
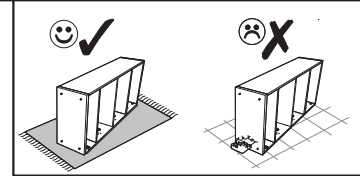



8



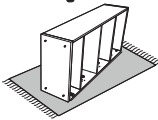
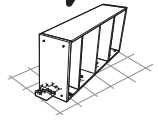

9

J23		x14
P2		3x16 x10

 **A=B**









J23

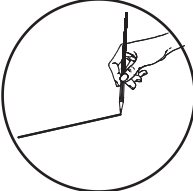

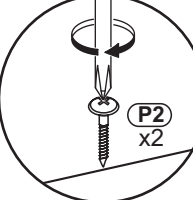

P2
x2

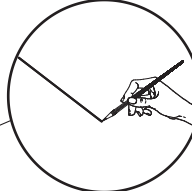

P2
x8

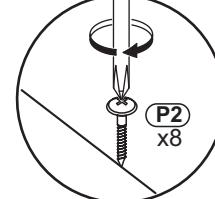

P2
x8

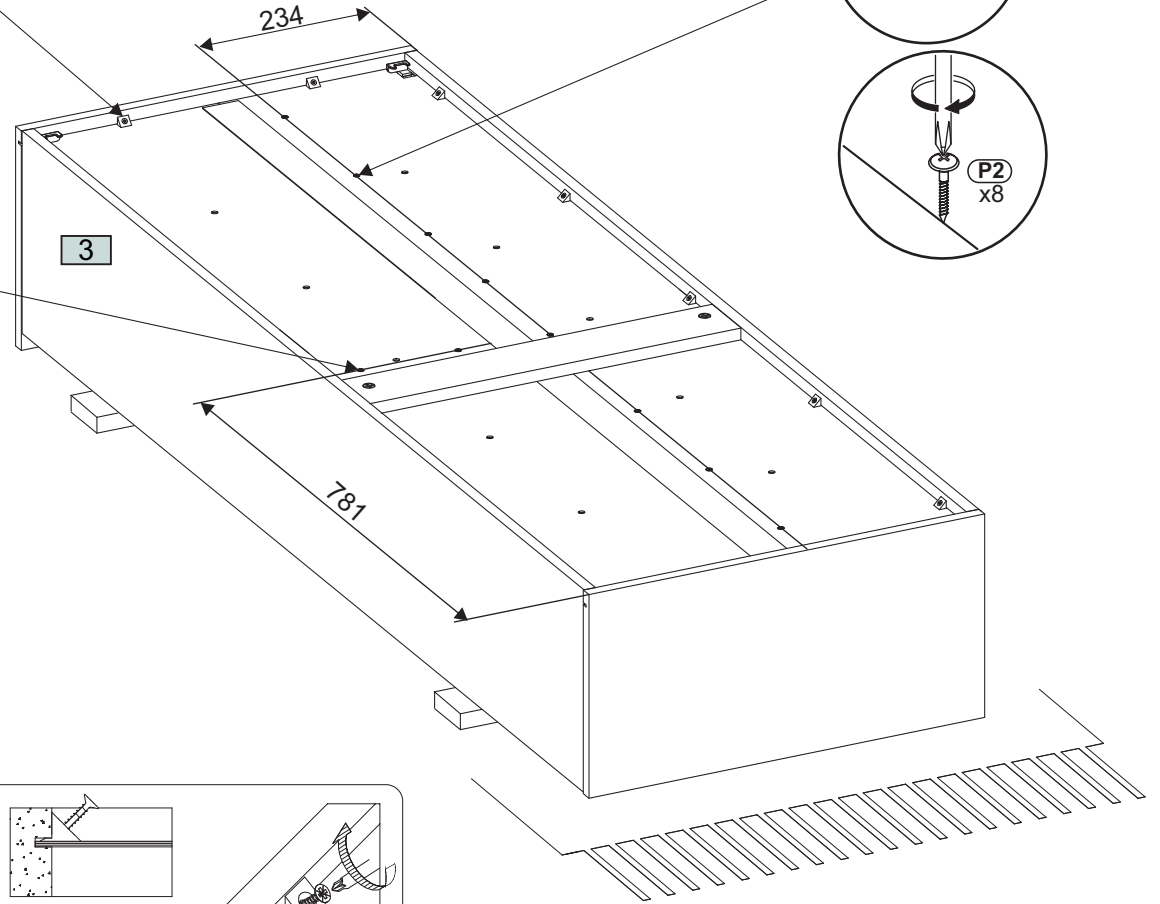
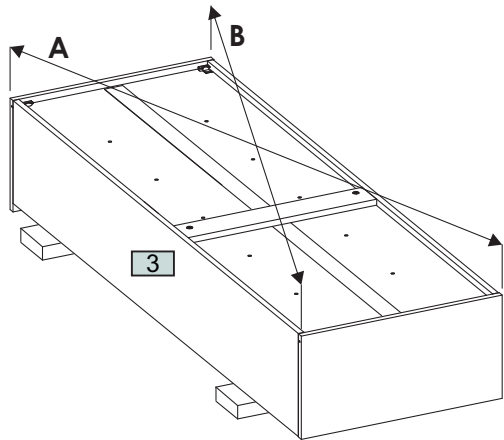

1

2

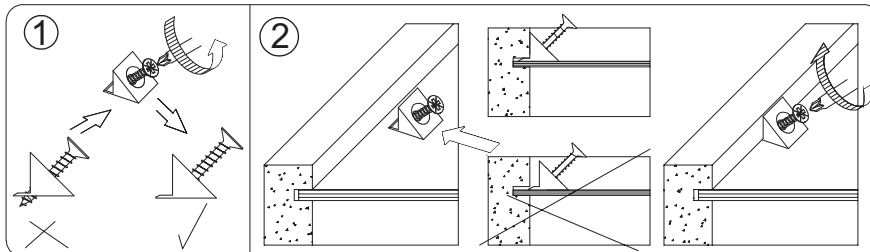

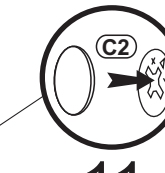
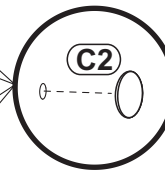
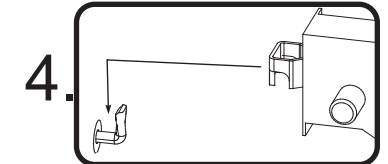
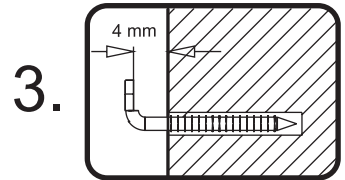
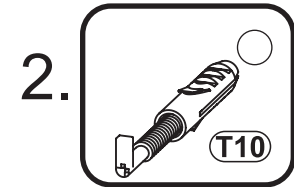
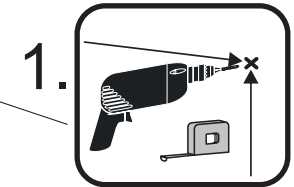
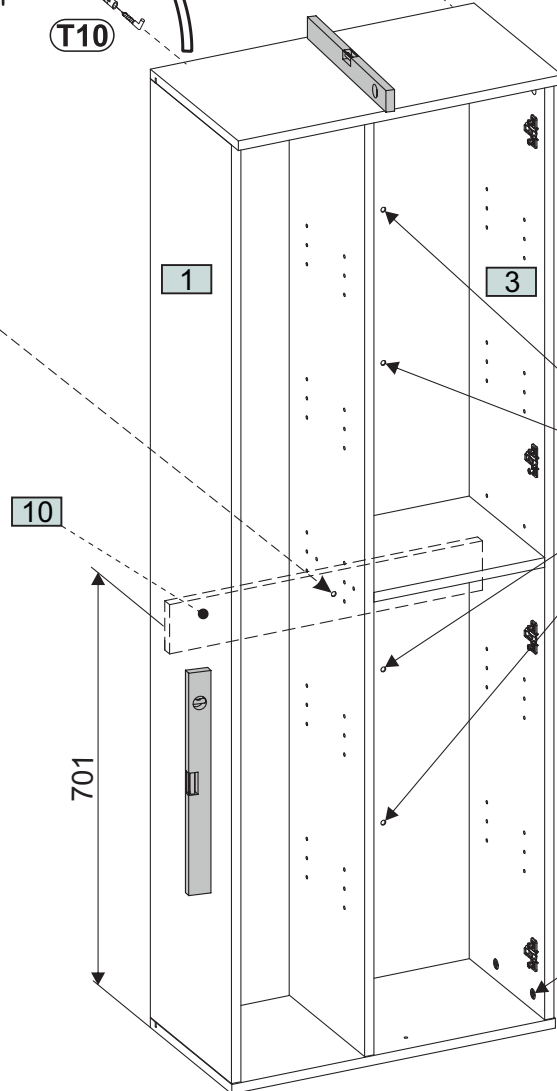
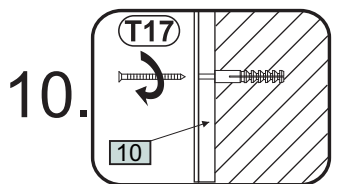
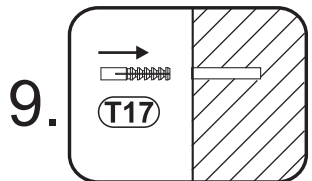
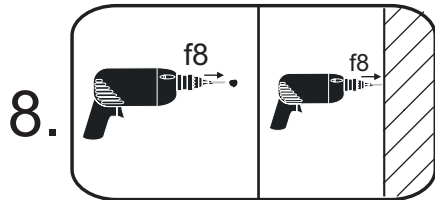
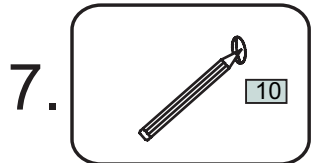
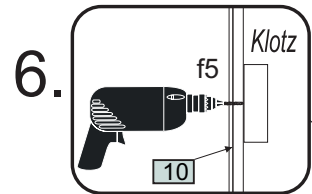
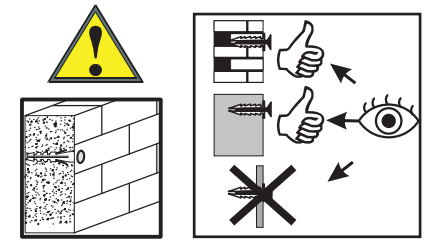
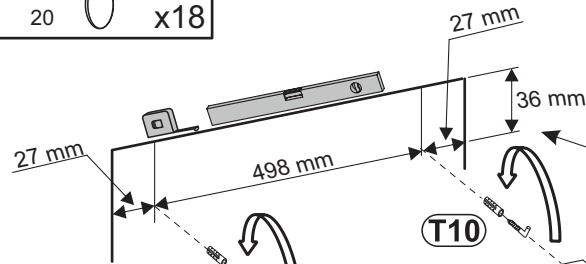
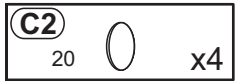
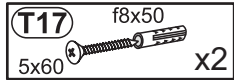
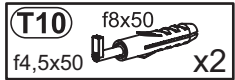

10



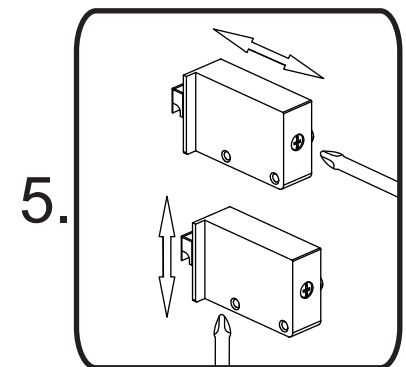

11.



11

W1  x16 **W12**  x10 **W13**  x10

LE  x5 **O51**  x1

