

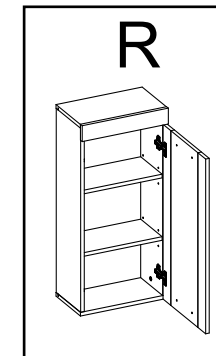

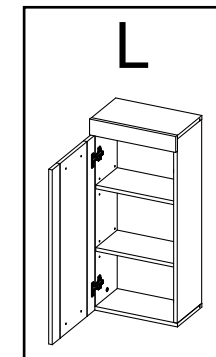

Nr	Ausmaß			St	Colli
1	775	204	15	1	1
2	775	204	15	1	1
3	360	204	15	1	1
4	360	204	15	1	1
5	328	170	15	2	1
6	360	65	15	1	1
7	716	356	15	1	1
8	769	342	2	1	1

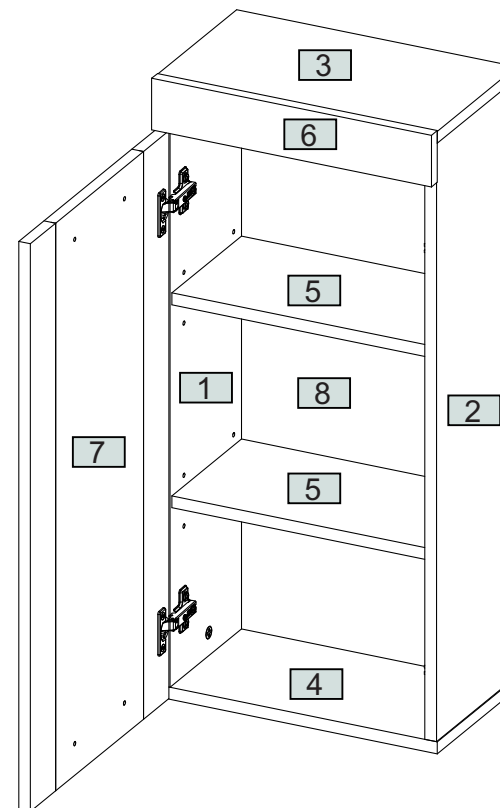

# 1

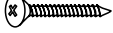
- P20**  x1
- P21**  x1
- S12**  4x30 x4

- B1**  18x28 x8

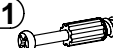
- T1**  x2

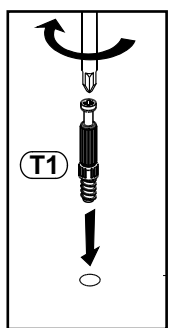
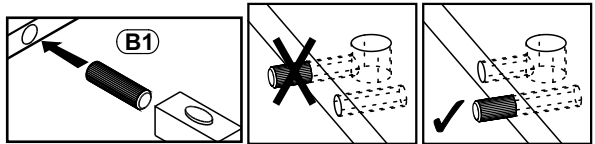
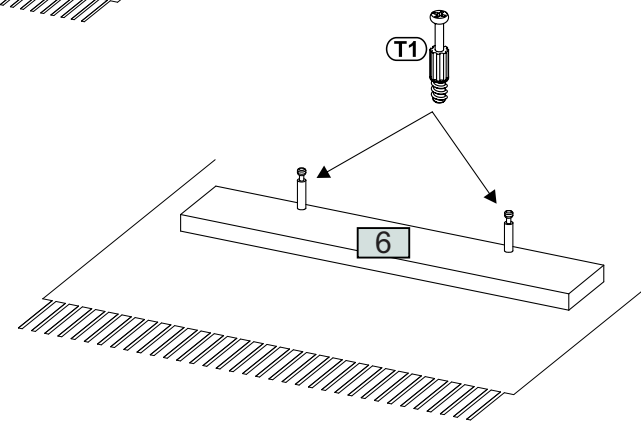
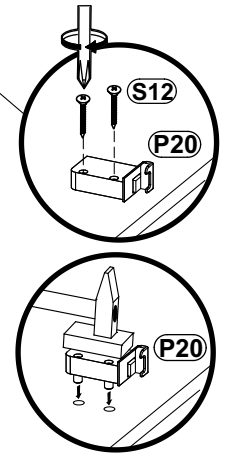
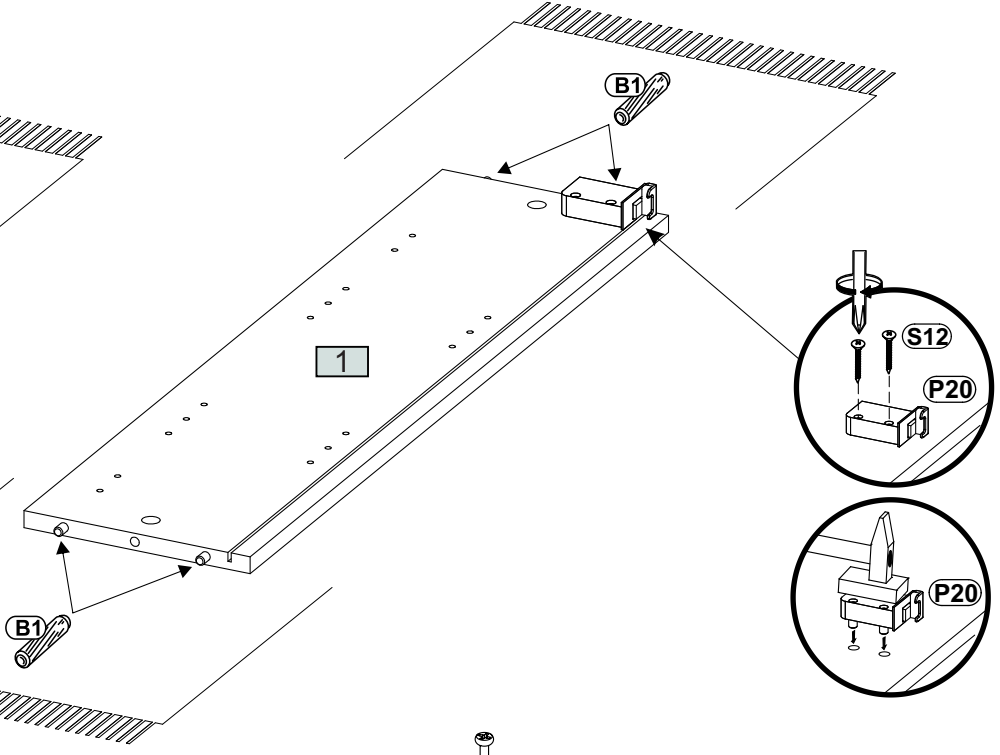
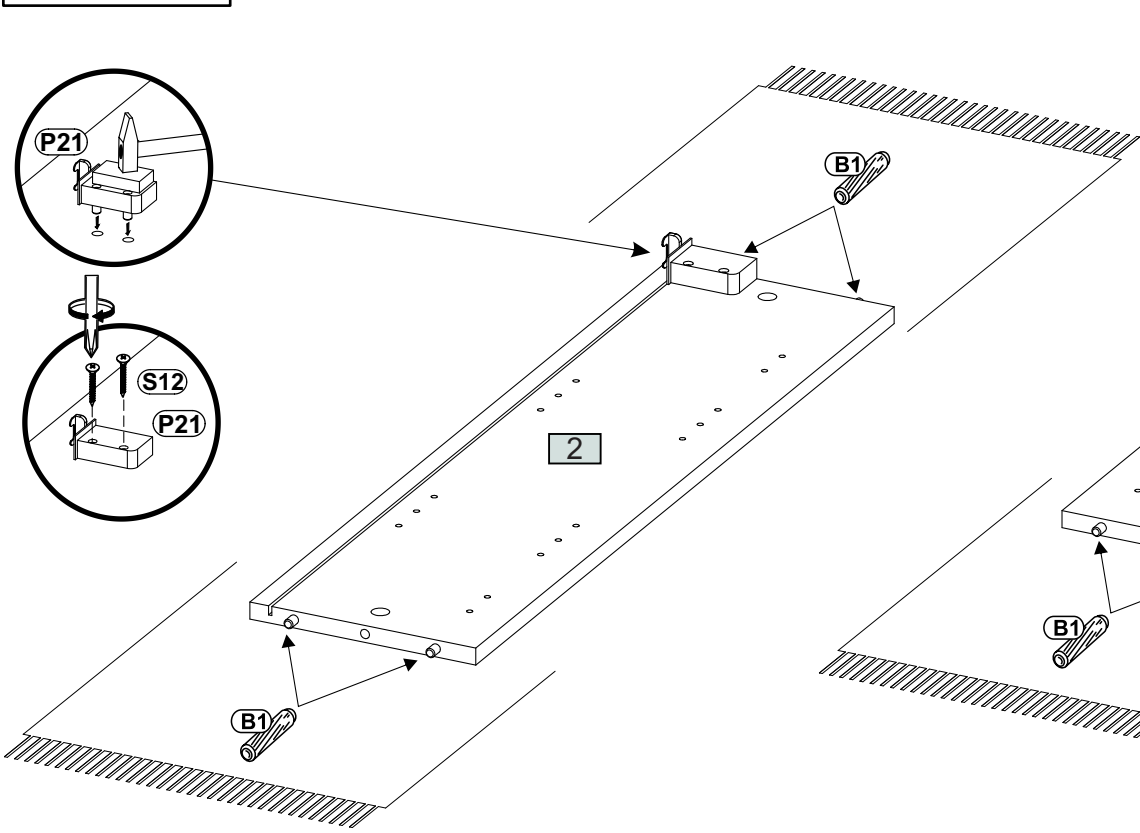
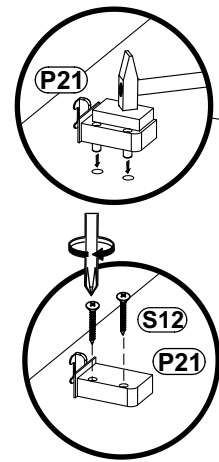
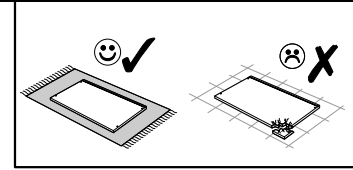

2

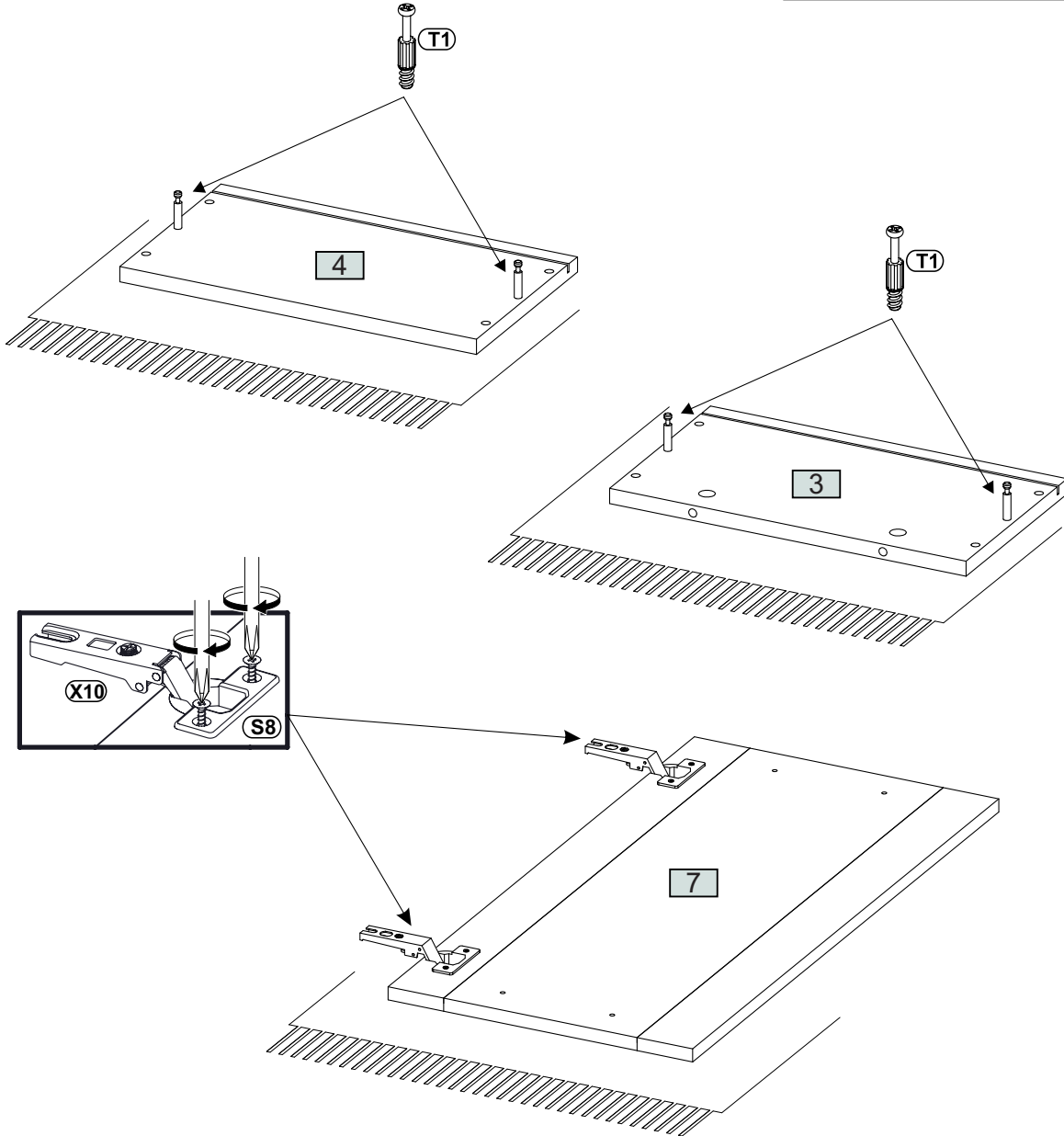
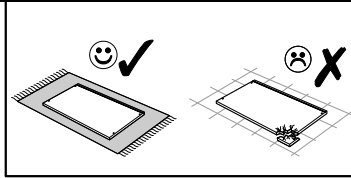
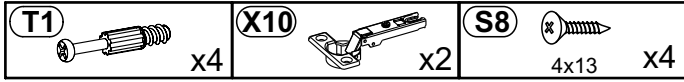

3

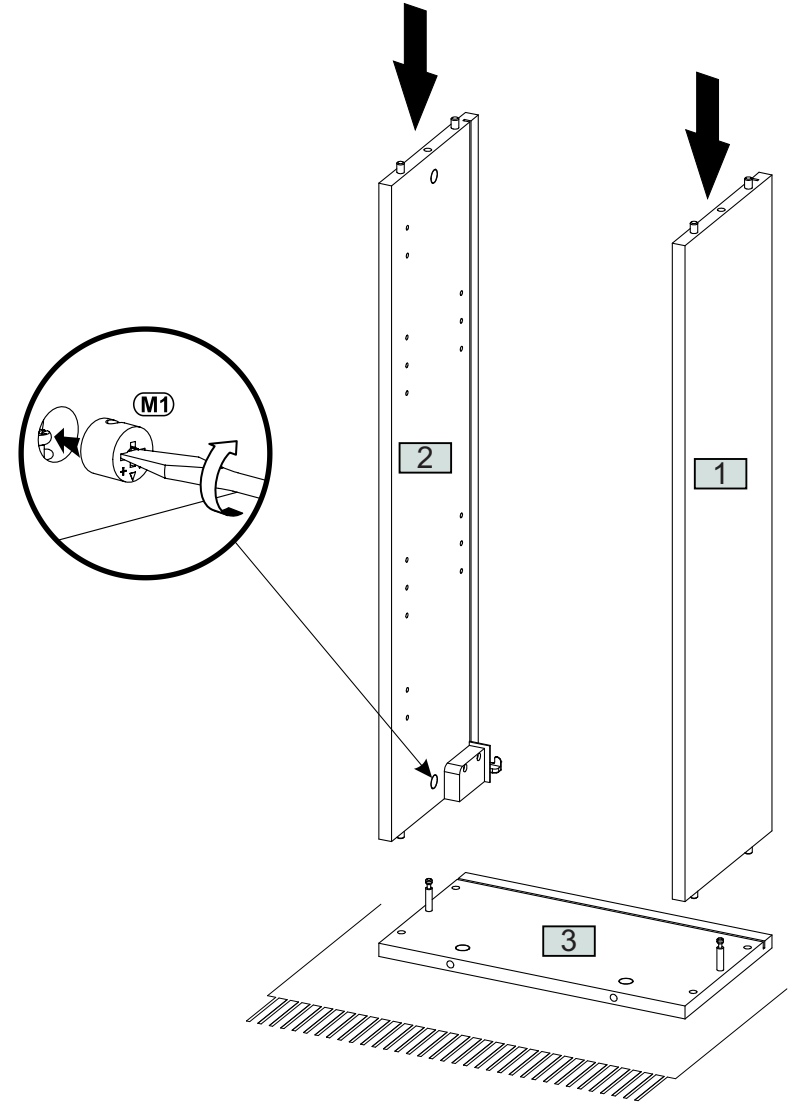
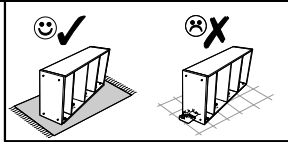

4

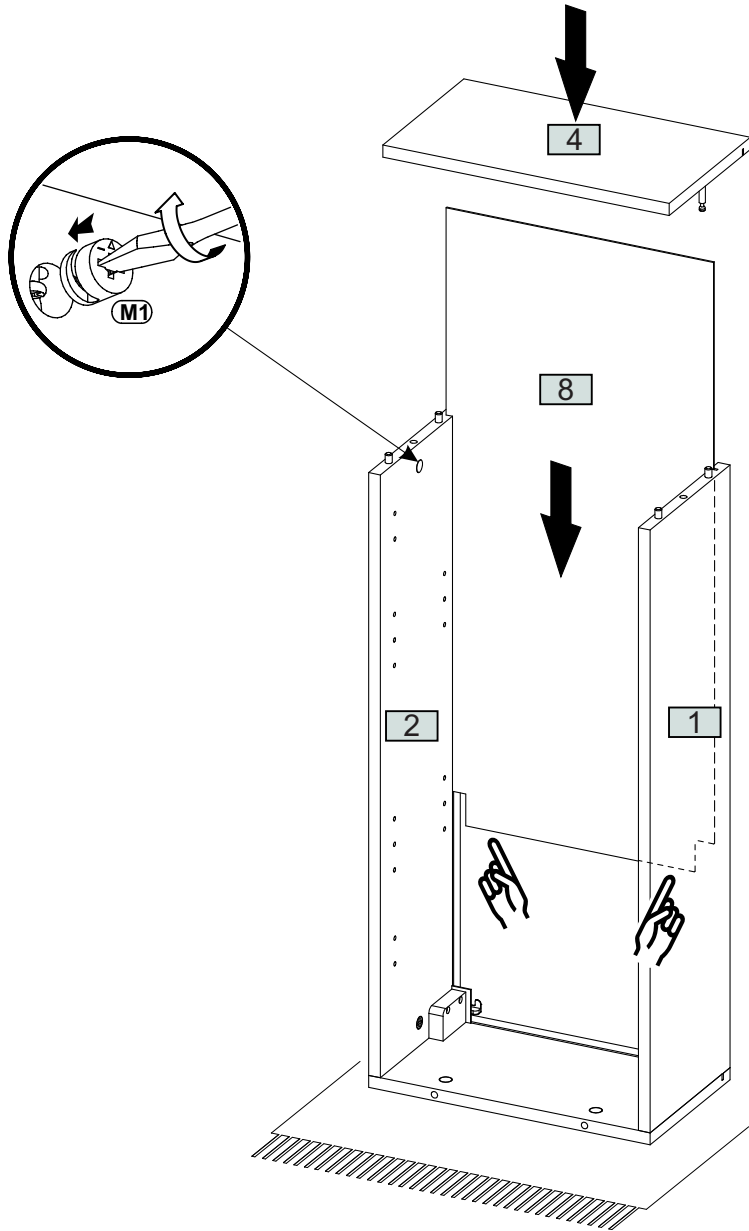
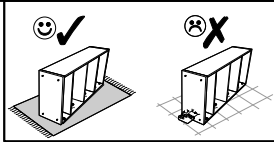

5

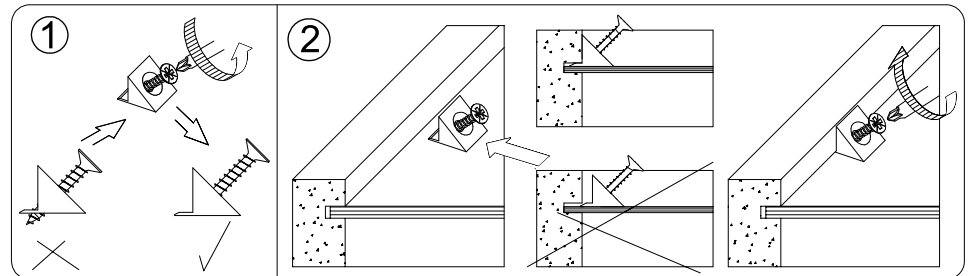
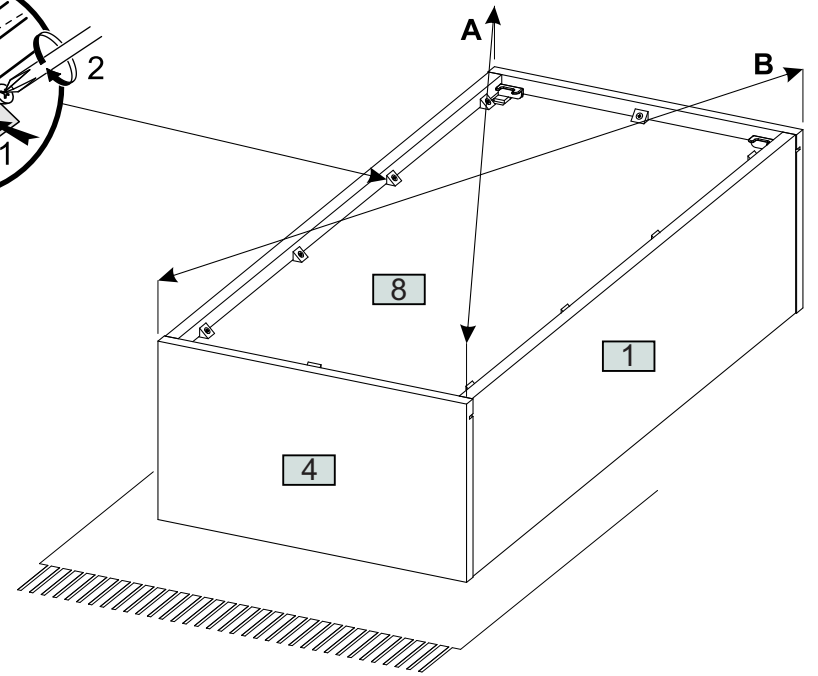
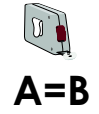
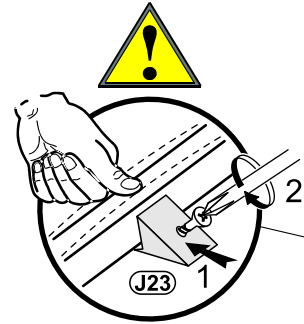
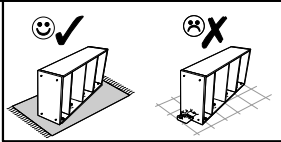
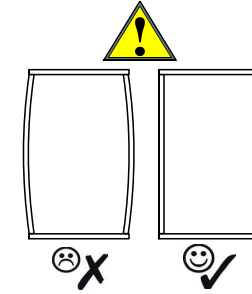
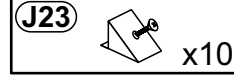

## 6

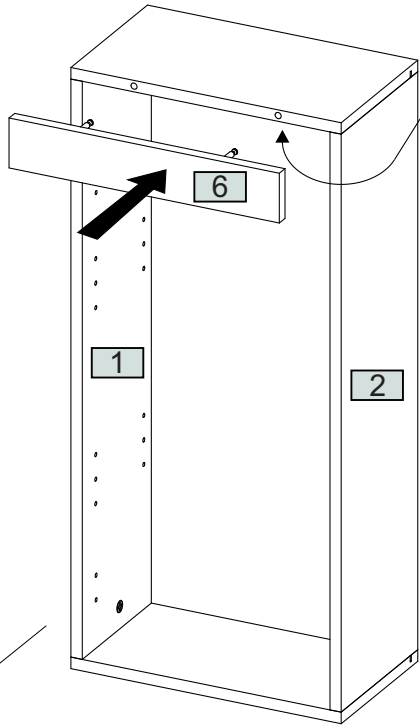
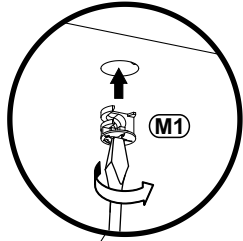
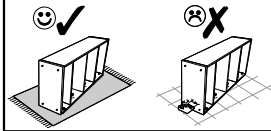

## 7

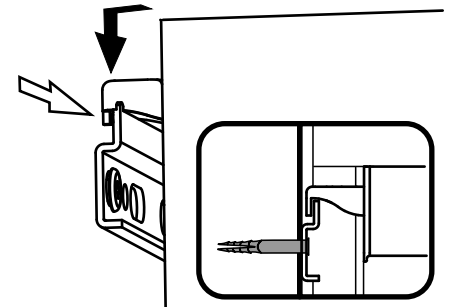
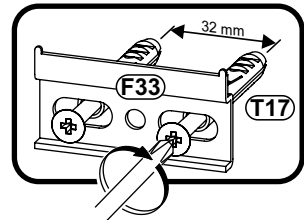
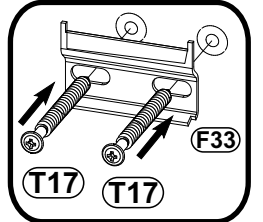
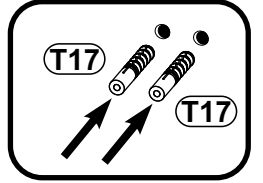
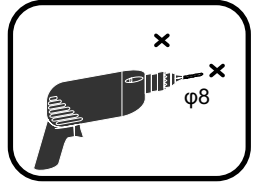
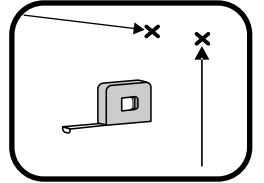
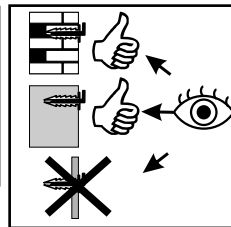
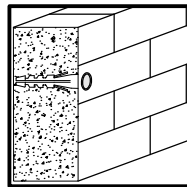
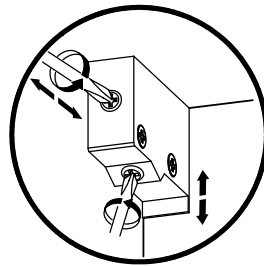
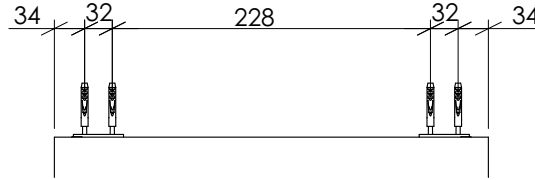
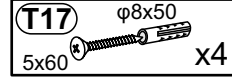
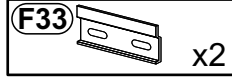

8

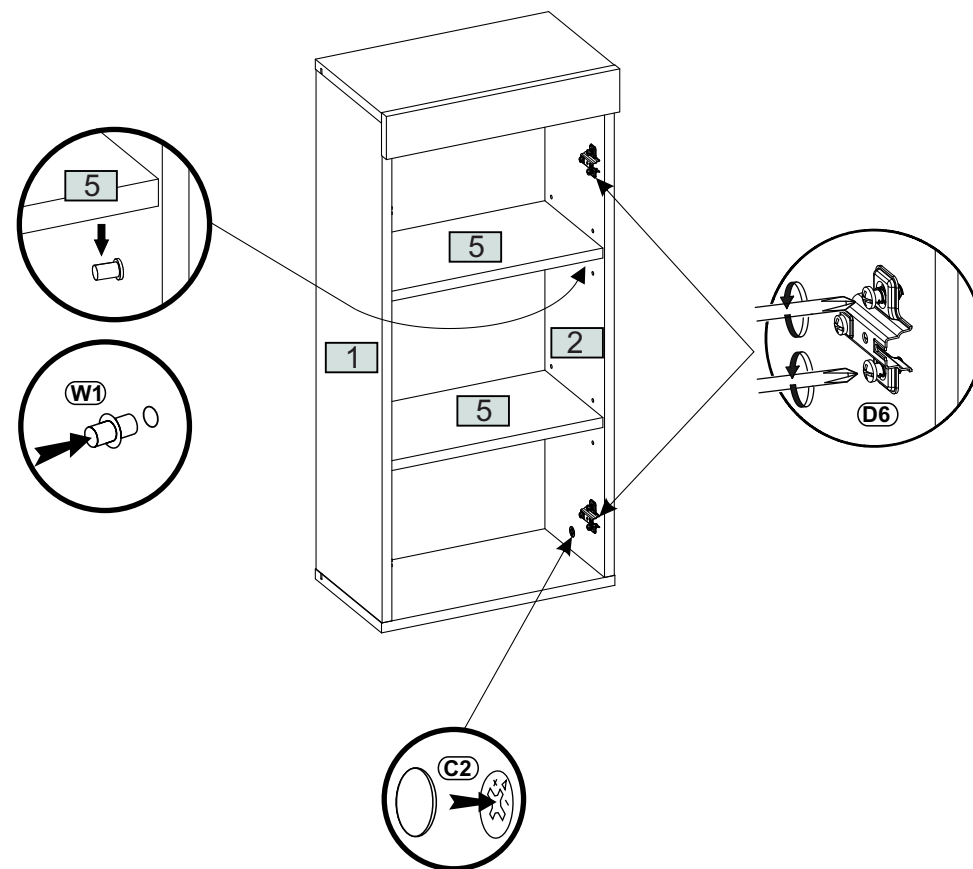
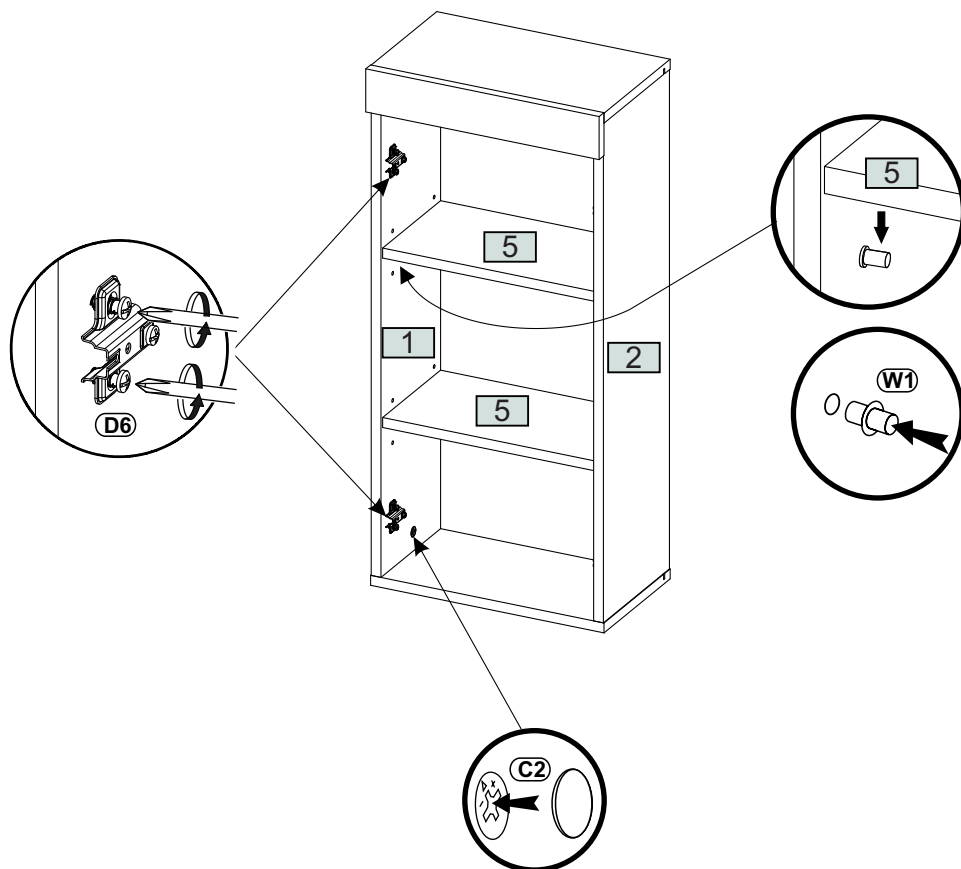
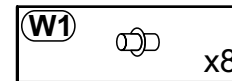
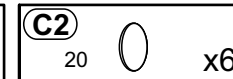
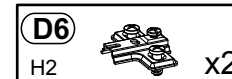
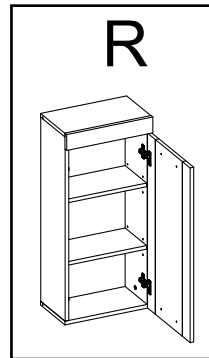
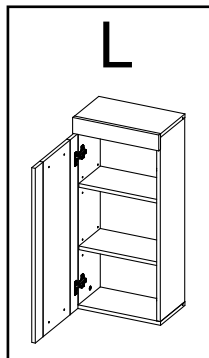
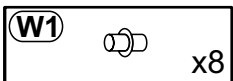
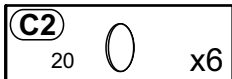
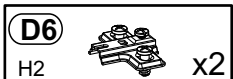

9

