

SALERNO

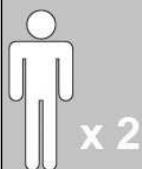
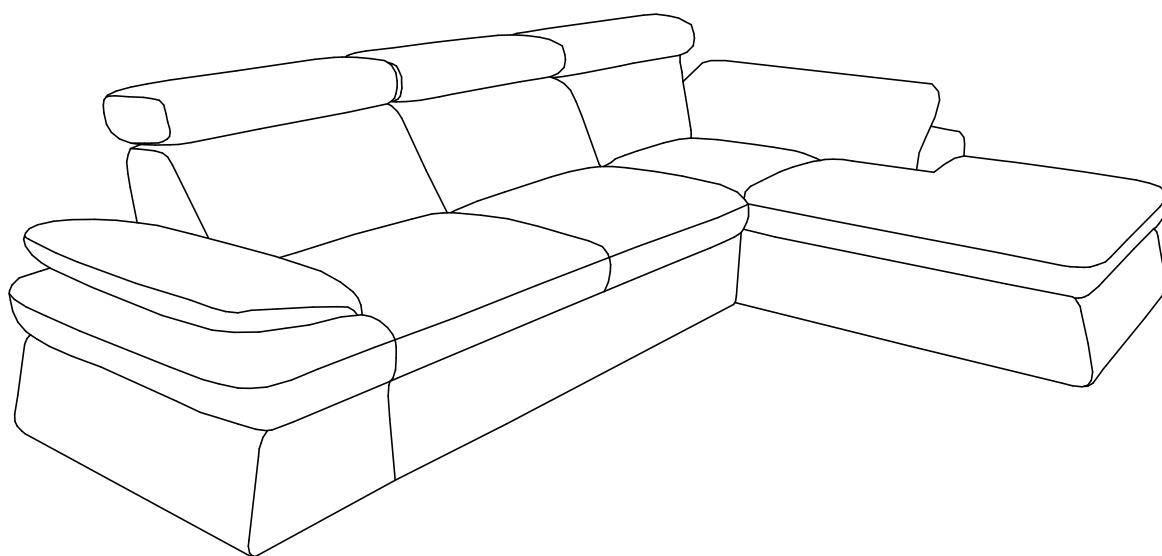

PL

INSTRUKCJA MONTAŻU
INSTRUKCJA OBSŁUGI

GB

ASSEMBLY INSTRUCTIONS
INSTRUCTION MANUAL

D

MONTAGEANLEITUNG
BEDIENUNGSANLEITUNG

NL

HANDLEIDING VOOR DE MONTAGE
GEBRUIKSAANWIJZING

TR

MONTAJ TALIMATI
KULLANIM KLAVUZU

RU

ИНСТРУКЦИЯ ПО МОНТАЖУ
ИНСТРУКЦИЯ ПО ЭКСПЛУАТАЦИИ

RO

INSTRUCȚIUNI DE INSTALARE
INSTRUCȚIUNI DE UTILIZARE

IT

ISTRUZIONI DI MONTAGGIO
MANUALE DI ISTRUZIONI

FR

NOTICE DE MONTAGE
MANUEL 'INSTRUCTIONS

SK

MONTÁŽNY NÁVOD
NÁVOD NA POUŽITIE

HU

SZERELÉSI ÚTMUTATÁS
KEZELÉSI UTASÍTÁS

CZ

MONTÁŽNÍ NÁVOD
NÁVOD K POUŽITÍ

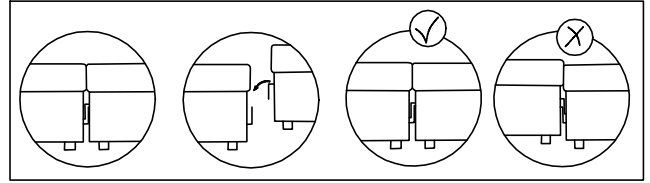
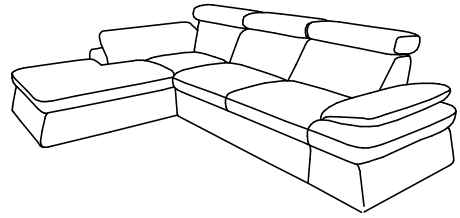
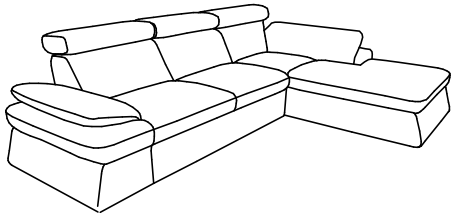

1

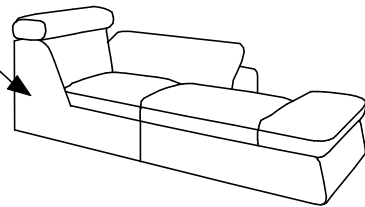
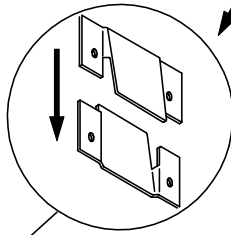
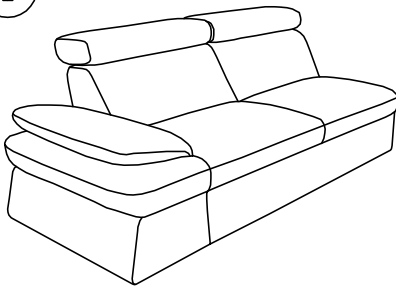



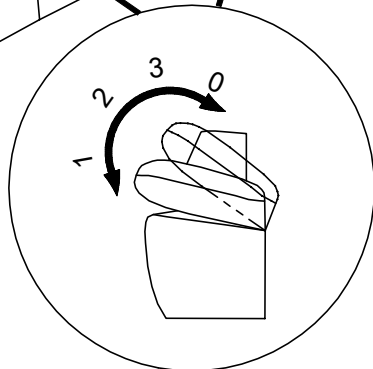
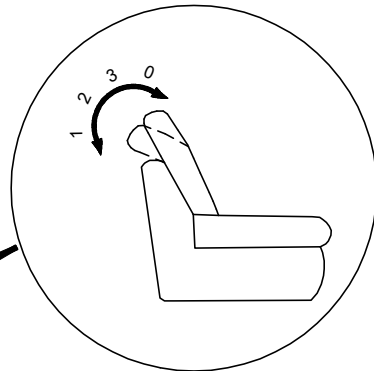
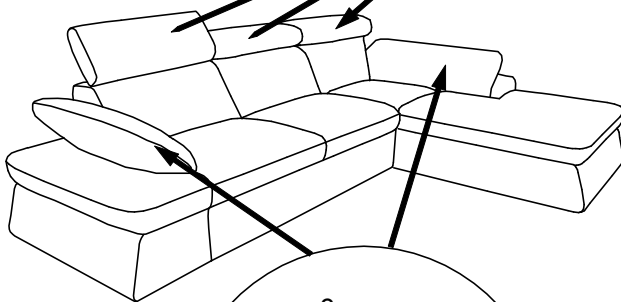

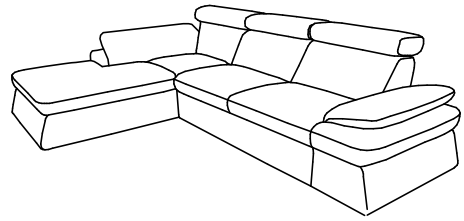
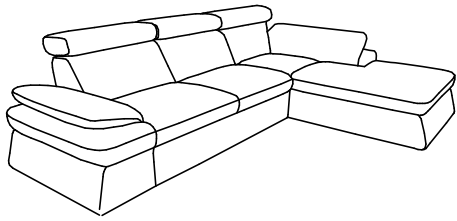





2



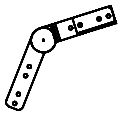
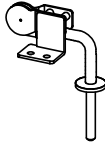

Service - Assistenza - Dienstverlening - Serwis - Servis - Szerviz - Сервисная служба

<p>A</p>  <p>.....</p>	<p>B</p>  <p>.....</p>	<p>C</p>  <p>Ø 5 x 50</p> <p>.....</p>
<p>D</p>  <p>Ø 4 x 20</p> <p>.....</p>	<p>E</p>  <p>M6 x 20</p> <p>.....</p>	<p>F</p>  <p>M6 x 25</p> <p>.....</p>
<p>G</p>  <p>.....</p>	<p>H</p>  <p>.....</p>	<p>I</p>  <p>Ø 50x50</p> <p>.....</p>
<p>J</p>  <p>.....</p>	<p>K</p>  <p>M6 x 40</p> <p>.....</p>	<p>L</p>  <p>M6 x 25</p> <p>.....</p>