

Nikita II (2AL-3HO)(3HO-2AL) RGB LED+SOUND SYSTEM







- | | |
|----------------------------------|--------------------------------|
| (DE) Montageanleitung | (IT) Istruzioni di montaggio |
| (PL) Instrukcja montażu | (FR) Notice de montage |
| (NL) Handleiding voor de montage | (RO) Instrucțiuni de asamblare |
| (GB) Assembly instructions | (SK) Montážny návod |
| (TR) Montaj talimatı | (CZ) Montážní návod |
| (RU) Инструкция по монтажу | (HU) Szerelési útmutató |

Service - Servis - Dienstverlening - Servis - Serwis - Сервисная служба - Servizio - Service
 Serviciu - Služby - Szolgáltatás

Name - Nazwa - Naam - Name - Isim - название
 Nome - Nom - Numele - Meno - Jméno - Neve

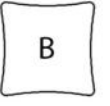

Nikita II (2AL-3HO)(3HO-2AL) RGB LED+SOUND SYSTEM

 A	 B	 200cm 40cm	 1x	 200cm	 K
7x	55x55 2x	45x45 1x	1x	1x	1x



09-07-2024

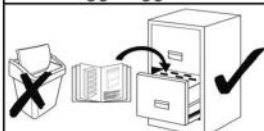
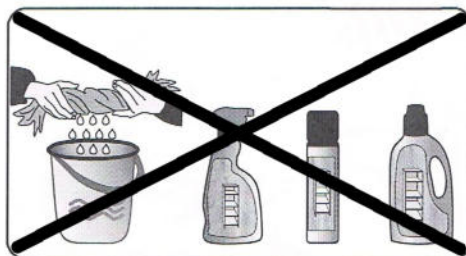

- | | | | |
|---|--|---|---|
|  <p>200cm
40cm</p> |  <p>1x</p> |  <p>200cm</p> |  <p>K</p> |
| 1x | 1x | 1x | 1x |

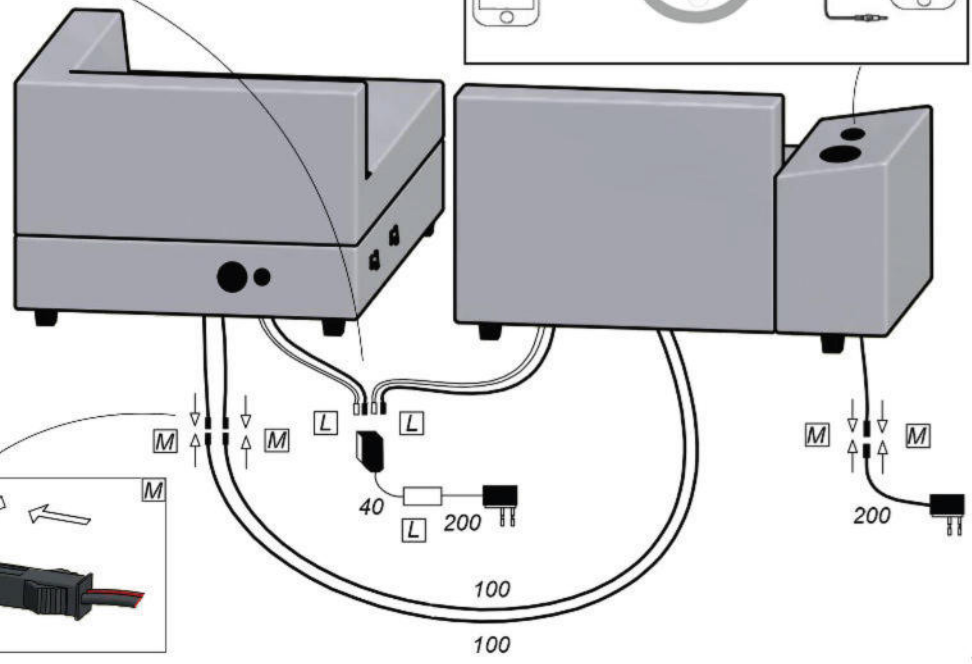
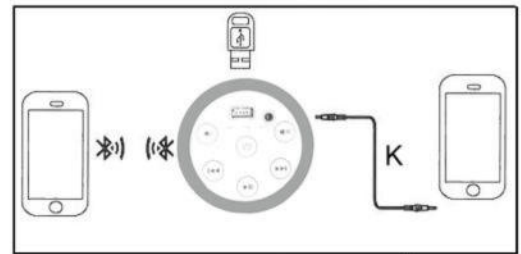
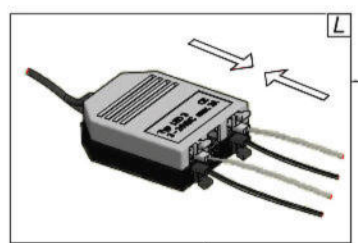
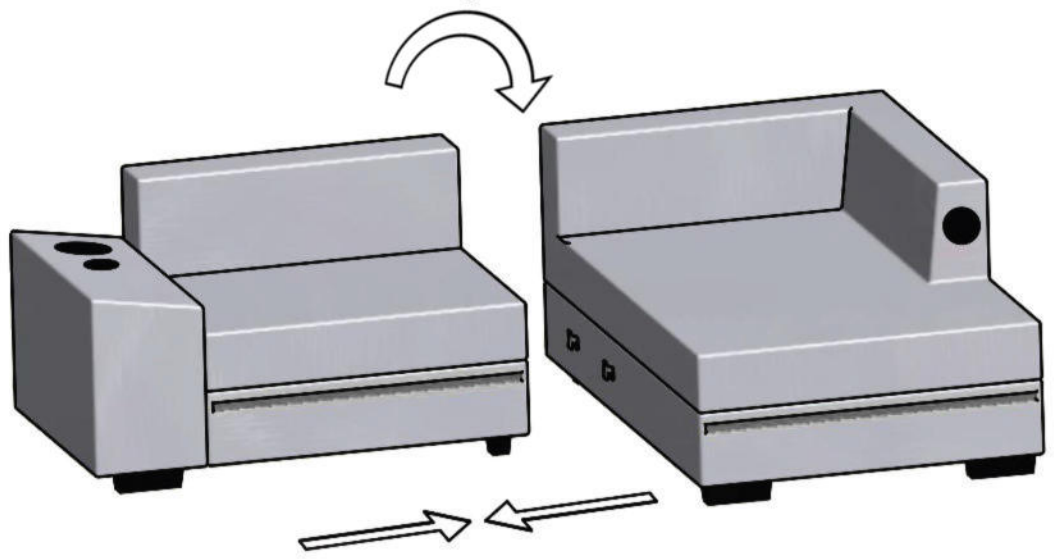
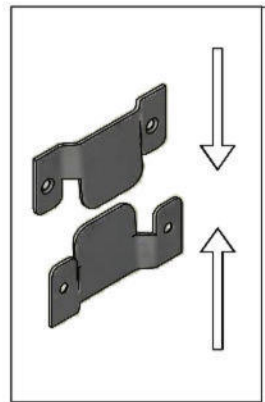

09-07-2024

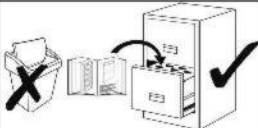
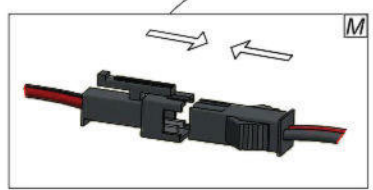
Nikita II (2AL-3HO)(3HO-2AL) RGB LED+SOUND SYSTEM

- DE** Alle elektrischen Komponenten, die in den Möbeln verwendet werden, müssen in den für Elektroschrott vorgesehenen Behälter entsorgt werden.
- PL** Wszystkie elementy elektryczne zastosowane w meblach należy wyrzucać do pojemników przewidzianych na odpady elektryczne.
- NL** Alle in meubilair gebruikte elektrische onderdelen moeten worden weggegooid in de daarvoor bestemde containers voor elektrisch afval.
- GB** All electrical components used in furniture should be disposed of in the containers provided for electrical waste.
- TR** Mobilyalarda kullanılan tüm elektrikli bileşenler, elektrikli atıklar için sağlanan konteynerlere atılmalıdır.
- RU** Все электрические компоненты, используемые в мебели, должны быть утилизированы в контейнеры, предусмотренные для электротехнических отходов.
- IT** Tutti i componenti elettrici utilizzati nei mobili devono essere smaltiti nei contenitori previsti per i rifiuti elettrici.
- FR** Tous les composants électriques utilisés dans le mobilier doivent être jetés dans les conteneurs prévus pour les déchets électriques.
- RO** Toate componentele electrice utilizate în mobilier trebuie aruncate în containerele prevăzute pentru deșeurile electrice.
- SK** Všetky elektrické komponenty použité v nábytku by sa mali likvidovať do kontajnerov určených na elektroodpad.
- CZ** Všechny elektrické součásti použité v nábytku by měly být likvidovány v kontejnerech určených pro elektroodpad.
- HU** A bútorokban használt összes elektromos alkatrészt az elektromos hulladékok számára fenntartott konténerekben kell megsemmisíteni.

Nikita II (2AL-3HO)(3HO-2AL) RGB LED+SOUND SYSTEM

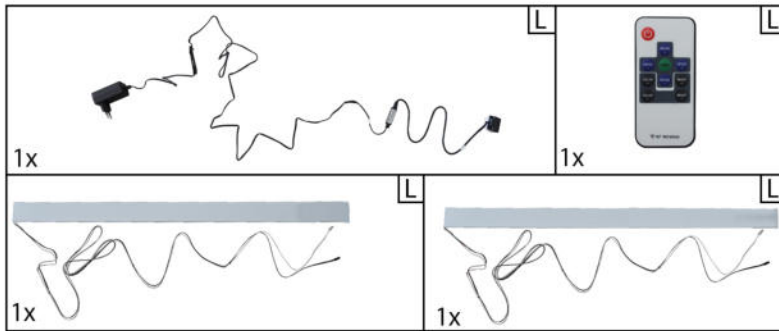
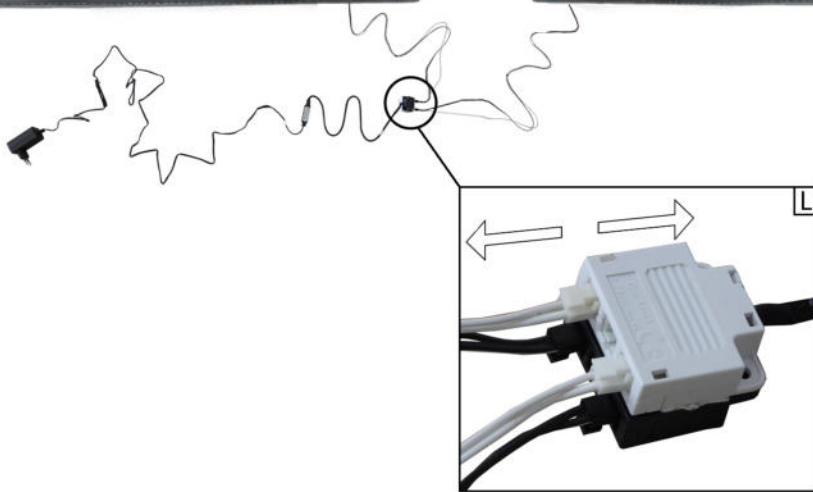
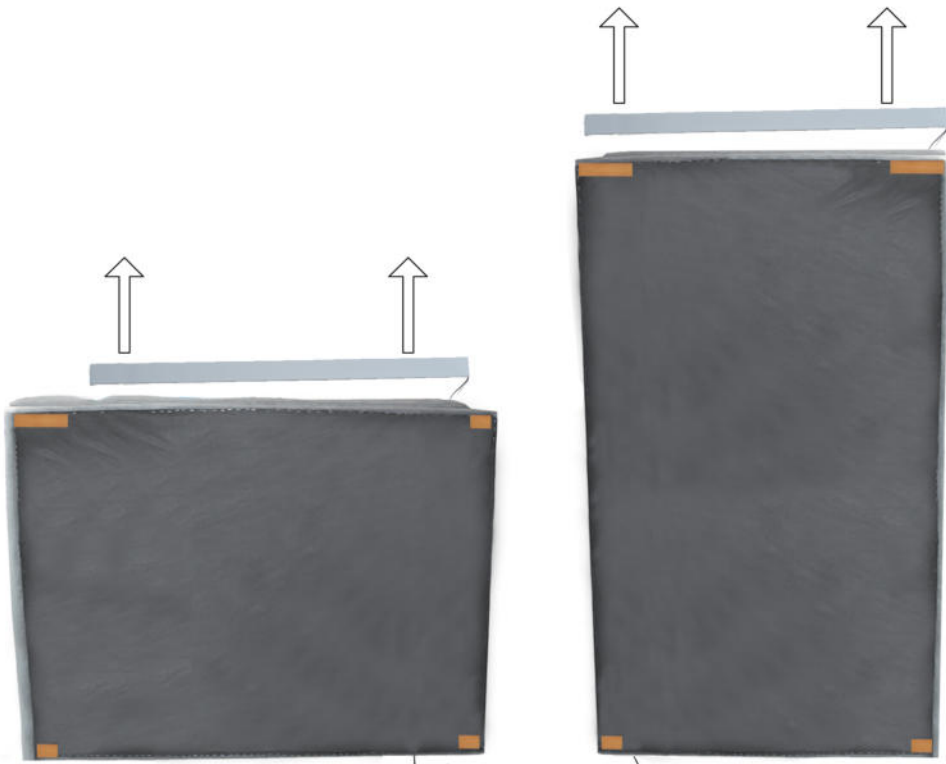

09-07-2024

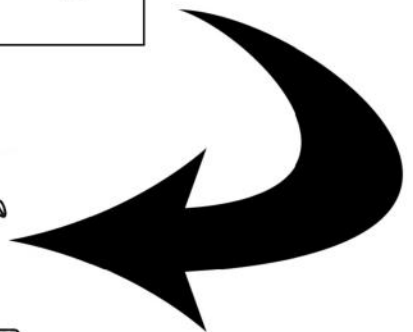
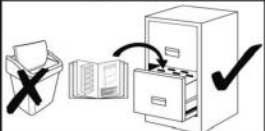
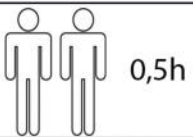

Nikita II (2AL-3HO)(3HO-2AL) RGB LED+ SOUND SYSTEM

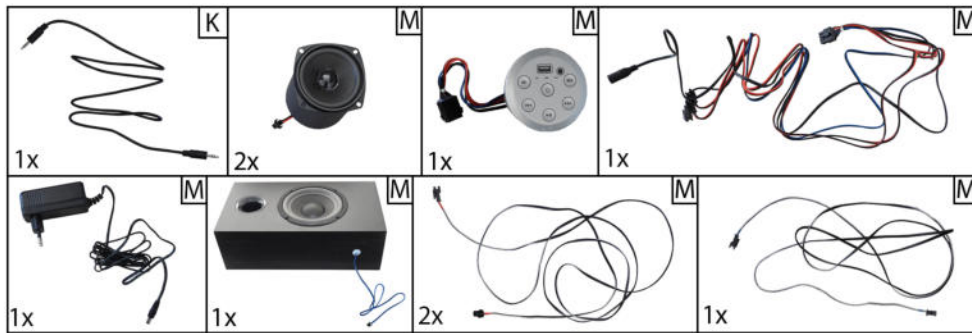
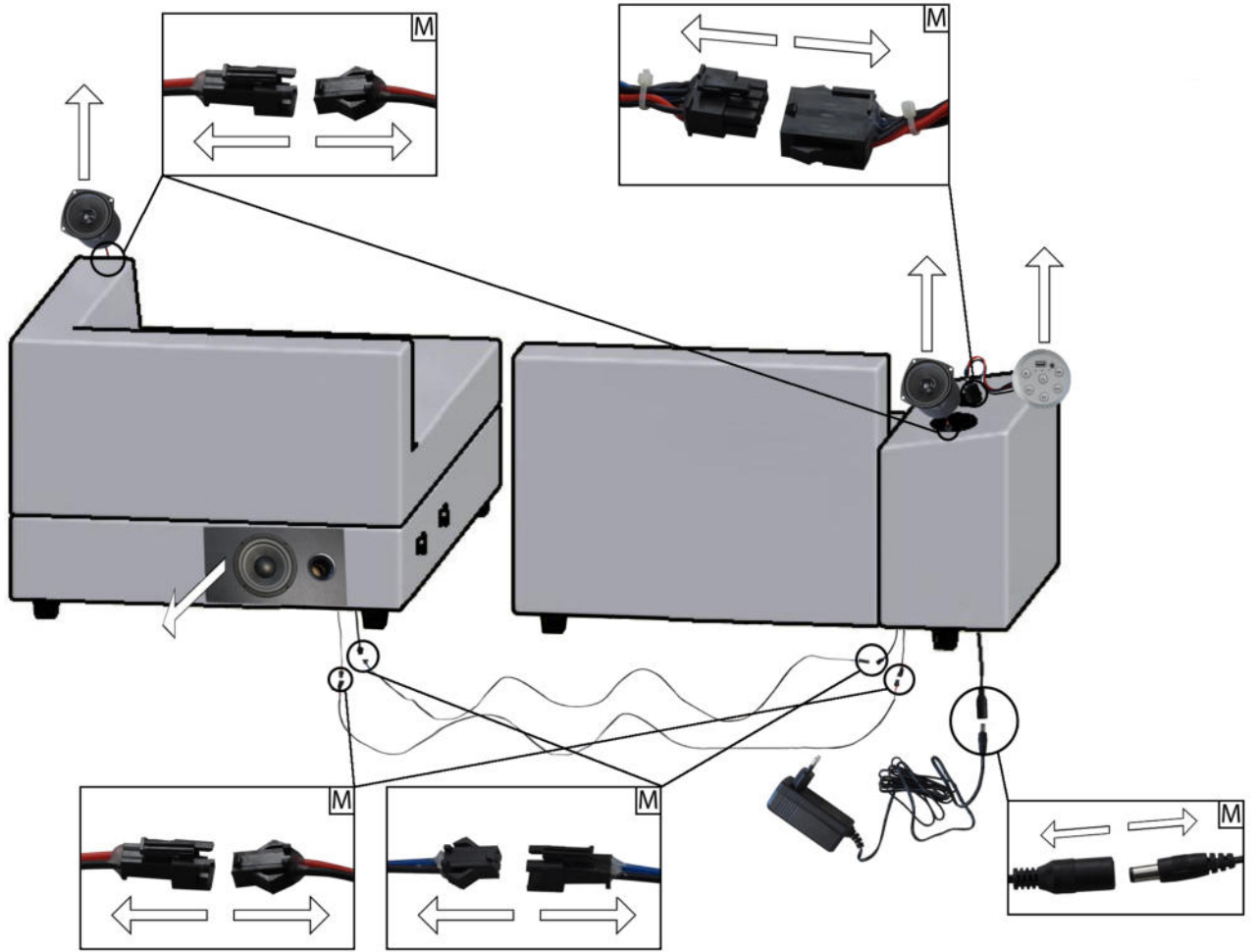

09-07-2024

