



(D) Montageanleitung

(GB) Assembly instructions

(FR) Notice de montage

(TR) Montaj talimatı

(IT) Istruzioni di montaggio

(NL) Handleiding voor de montage

(RU) Инструкция по монтажу

(CZ) Montážní návod

(HU) Szerelési útmutató

(RO) Instrucțiuni de montaj

(PL) Instrukcja montażu

(SK) Návod na montáž

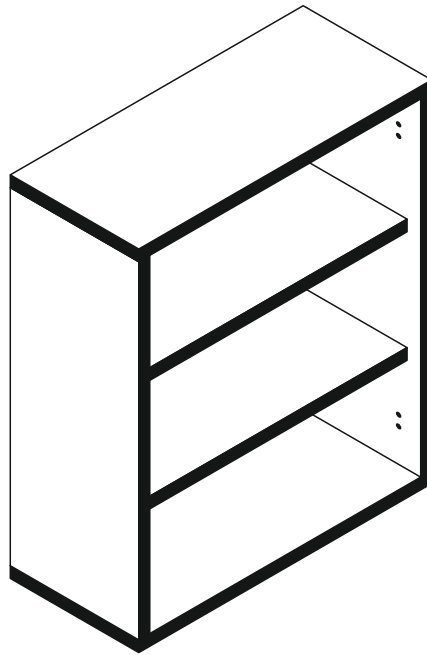

0200_81x109 Aktenregal





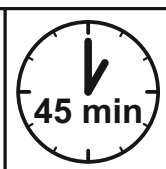
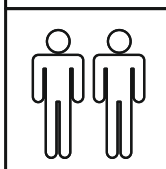
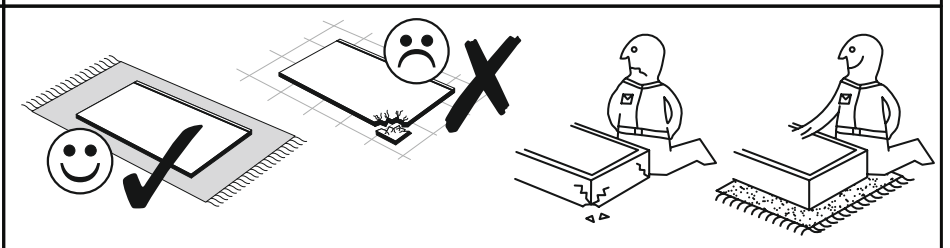
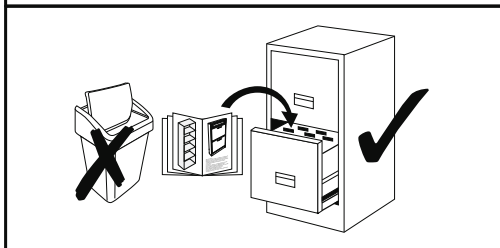
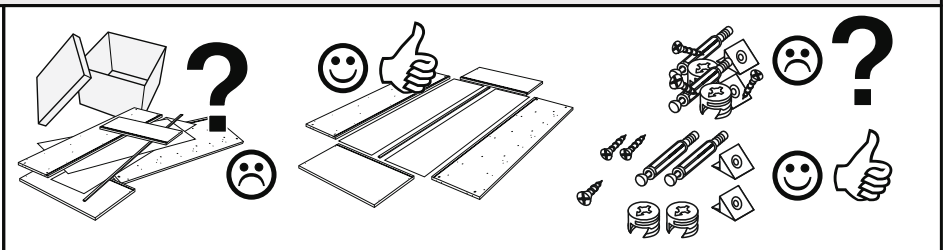
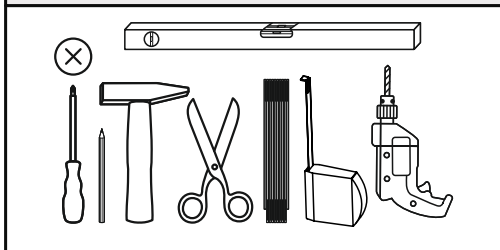

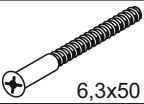

REPC-Nr.:

Service • Assistenza • Dienstverlening • Servis
Servis • Szerviz • Сервисная служба



Colli 1/1: 1 2 3 4 5 6 7 8 Beutel 1/1

Beutel 1/1

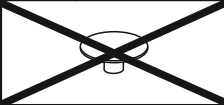
1-10 4x	 6,3x50	1-80 8x	 3,5x13	1-90 10x	 3,5x20	2-10 4x		2-20 4x	
2-162 8x		2-170 6x		5-185 4x		8-80 1x			
 <p>Artikel enthält keine Abdeckkappen für Excenter (Teil 2-10)!</p>									

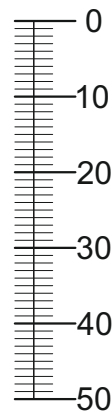

Colli 1/1

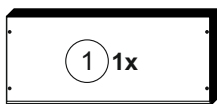

807 x 354

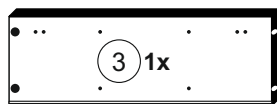

1042 x 354

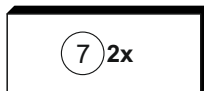

768 x 313

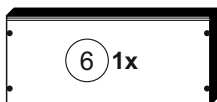

807 x 354

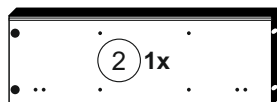

1042 x 354



1054 x 390

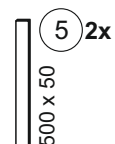

500 x 50

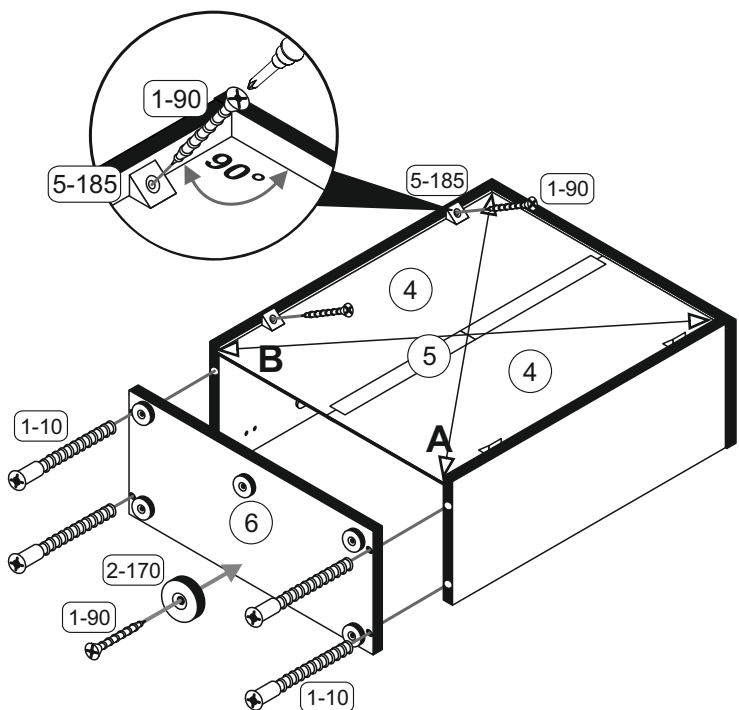
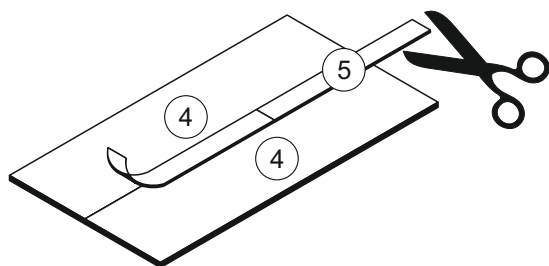
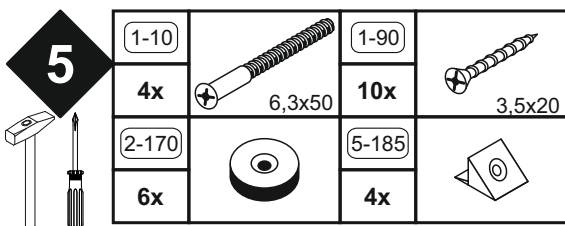
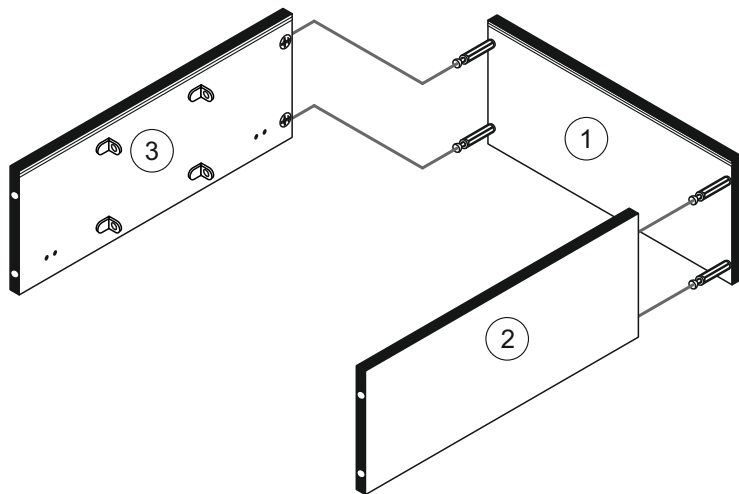
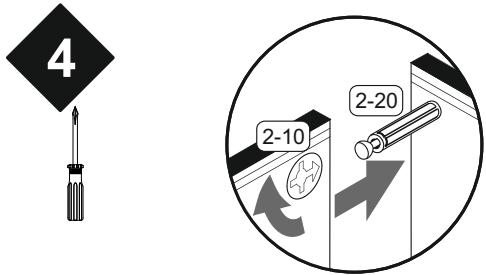
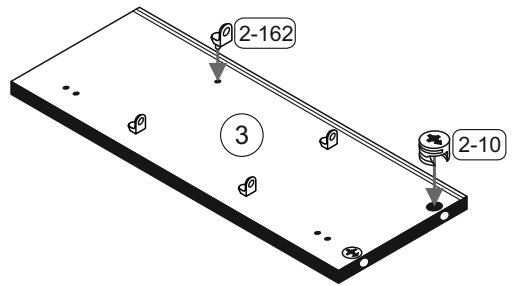
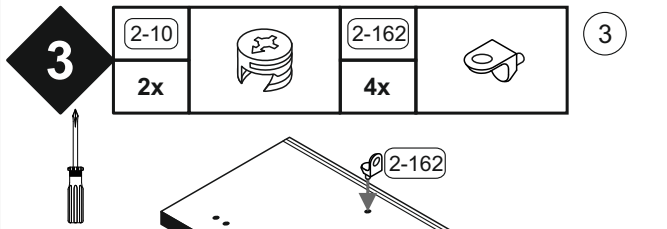
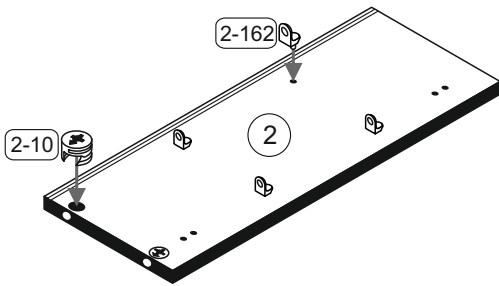
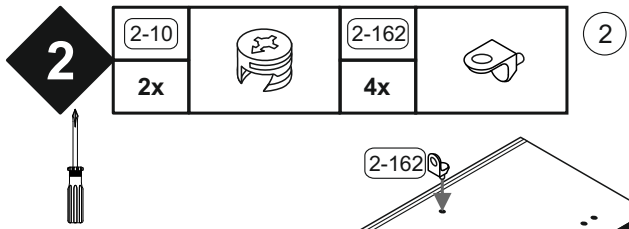
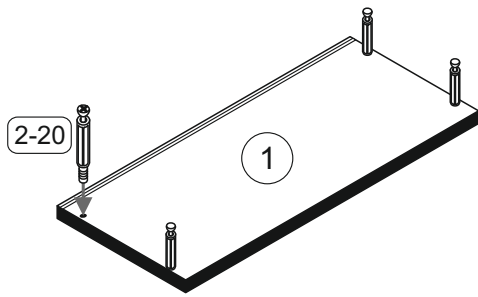
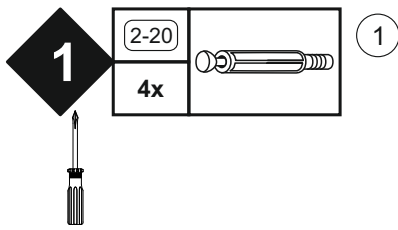

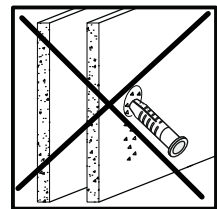
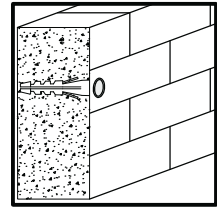
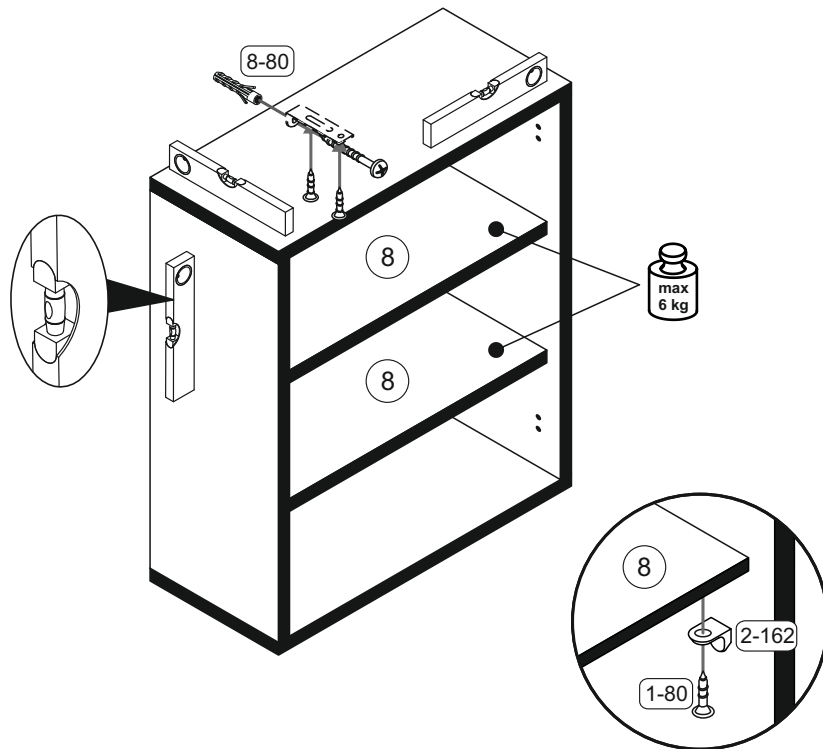
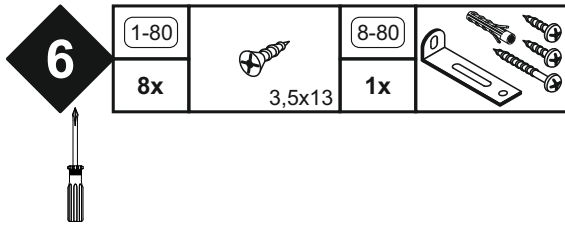

Achtung • Attention • Attenzione • Opgelet • Uwaga • Pozor • Figyelem • Atenție • Dikkat • Внимание	
(D)	Wandbefestigung dient als Kippschutz - unbedingt anbringen! Bei einigen Wandtypen kann ein Spezialdübel erforderlich sein!
(GB)	The wall fastening serves to prevent tipping - be absolutely sure to mount it! For certain wall types, a special wall plug may be necessary!
(FR)	La fixation murale sert de protection contre le basculement – à installer impérativement ! Pour certains types de murs il faut des chevilles spéciales !
(TR)	Duvardaki sabitleme, devrilmeye karşı bir emniyet tedbiridir ve mutlaka monte edilmelidir! Bazı duvar tiplerinde bunun için özel bir dübel gerekli olabilir!
(IT)	Il fissaggio alla parete serve da protezione anti-ribaltamento – attaccarla assolutamente! Per alcune strutture di parete può essere necessario un tassello speciale!
(NL)	Bevestiging aan de muur dient als kantelbescherming – zeker en vast bevestigen! Bij enkele muurtypes is een speciale plug misschien vereist!
(RU)	Обязательно установите крепление на стене во избежание опрокидывания! Для некоторых типов стен может потребоваться специальный дюбель!
(CZ)	Montáž na stěnu slouží jako ochrana proti převrnutí – bezpodmínečně umístěte! U některých typů stěn může být zapotřebí speciální hmoždinka!
(HU)	A terméket a falhoz kel rögzíteni, különben az felborulhat! Egyes faltípusoknál speciális tiplik kell használni!
(RO)	Sistemul de fixare la perete servește ca protecție la răsturnare - de montat obligatoriu! Pentru unele tipuri de pereți este posibil să fie necesar un diblu special!
(PL)	Mocowanie do ściany jest jednocześnie zabezpieczeniem przed przewróceniem – koniecznie zamontować! Do niektórych rodzajów ścian konieczne zastosować specjalne kołki mocujące.
(SK)	Upevnenie na stenu slúži ako ochrana proti prevráteniu – bezpodmienečne použite! Pre niektoré druhy stien môže byť potrebná špeciálna hmoždinka!