

23.10.2017

Stand

01

Revision

MVI

Verfasser

1 / 1

Seite(n)

Armlehnenfunktion

Bezeichnung

FOB_BE_0015

lfd. Nr.

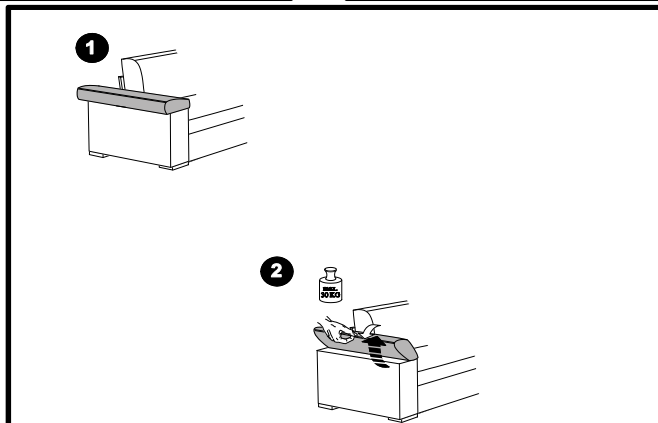
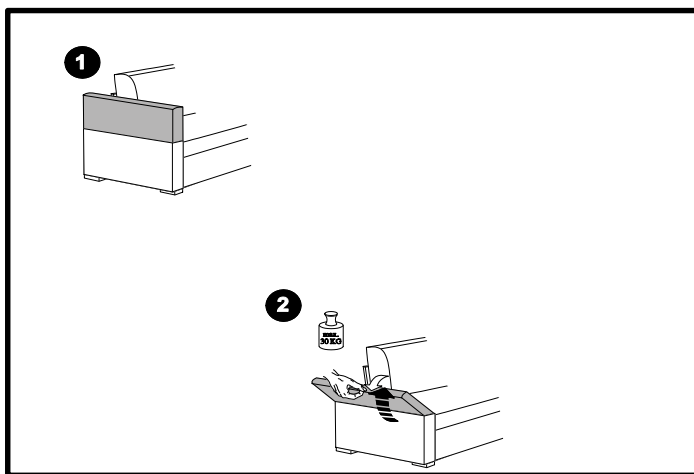
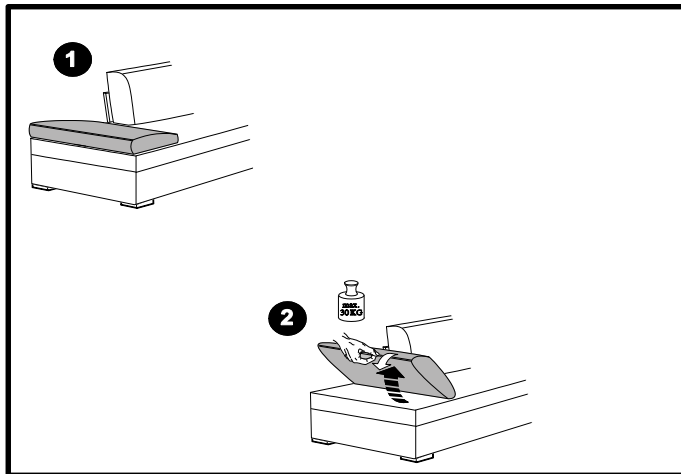

30.11.2011

Stand

00

Revision

VHÖ

Verfasser

1 / 1

Seite(n)

Bedienungsanleitung Elementverbinder

Bezeichnung

FOB_MO_0004

lfd. Nr.

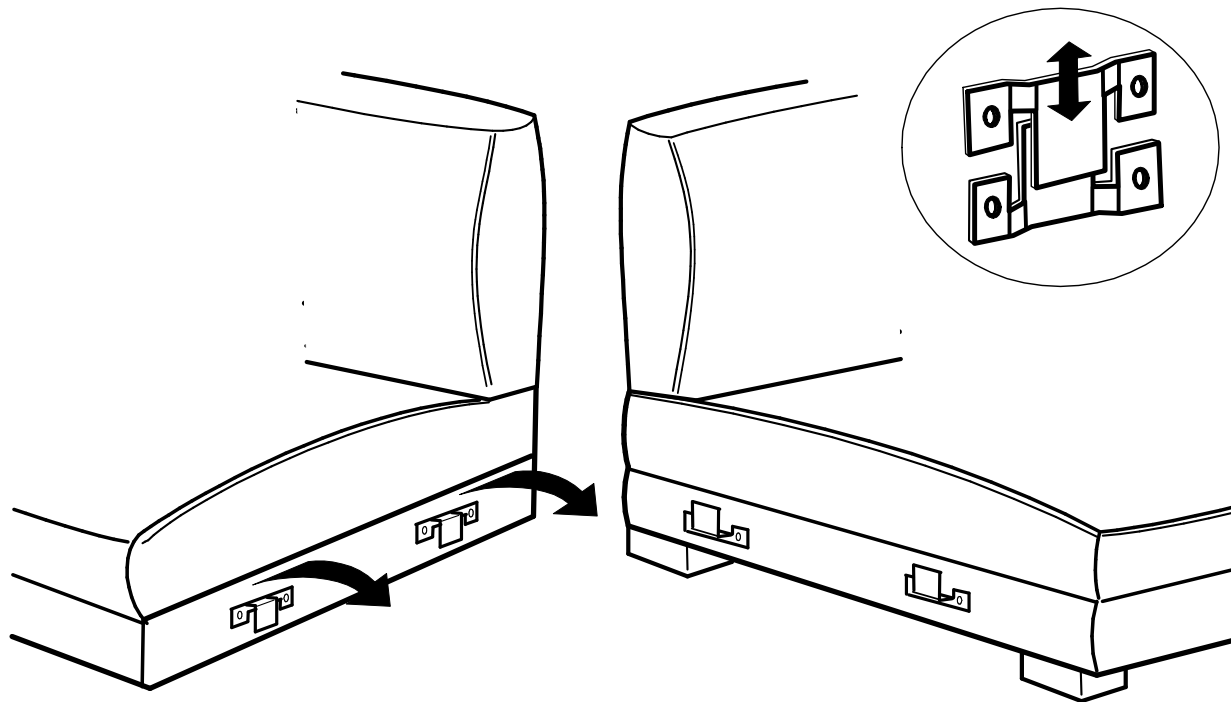

FOB_FU_0695

Metallkufe

DE Fuß / Position

EN Foot / Position

NL Poot / Positie

IT Piedi / Posizione

RU Ноги / Позиция

FR Pied / Position

ES Pie / Posición

TR Ayak / Pozisyon

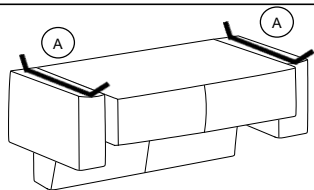

2-Sitzer mit 2 Armlehnen (SR60,SR75)

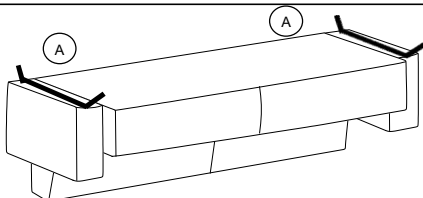

3-Sitzer mit 2 Armlehnen (SR 90)

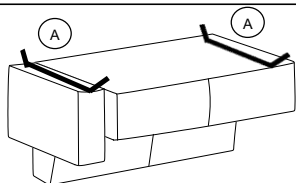

2-Sitzer mit AL. Links/rechts (SR60,SR75)

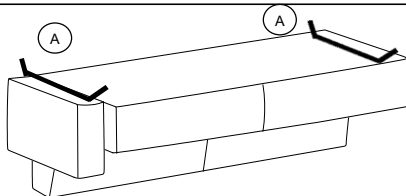

3-Sitzer mit AL. Links/rechts (SR 90)

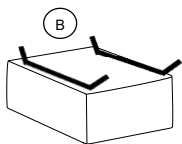

Hocker



Montage

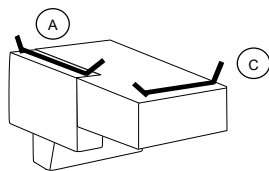

Longchair mit Armlehne li./re. (SR 90)

- A** Metallkufe 682 H200 Schwarz matt L950
Metallkufe 965 H200 Chrom glänzend L950
- C** Metallkufe 685 H200 Schwarz matt struktur L1255
Metallkufe 966 H200 Chrom glänzend L1255
- B** Metallkufe 689 H200 Schwarz matt L855
Metallkufe 967 H200 Chrom glänzend L855

A Höhe 20cm	B Höhe 20cm	C Höhe 20cm	D	E	F
Metallkufe	Metallkufe	Metallkufe			
Kundenseitig	Kundenseitig	Kundenseitig			

Modellnummer

35049

Stand

09.05.2023

Revision

01

Verfasser

RSZ

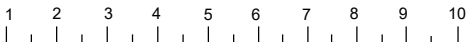

FOB_FU_0695

Metallkufe

DE Fuß / Position

EN Foot / Position

NL Poot / Positie

IT Piedi / Posizione

RU Ноги / Позиция

FR Pied / Position

ES Pie / Posición

TR Ayak / Pozisyon

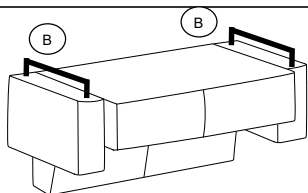

2-Sitzer mit 2 Armlehnen (SR60,SR75)

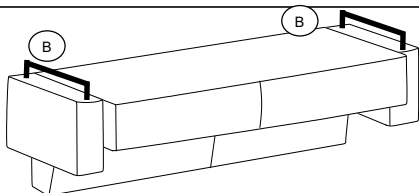

3-Sitzer mit 2 Armlehnen (SR 90)

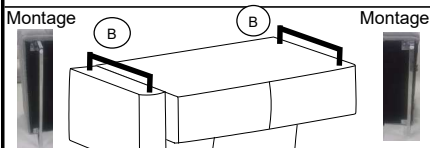

2-Sitzer mit AL. Links/rechts (SR60,SR75)

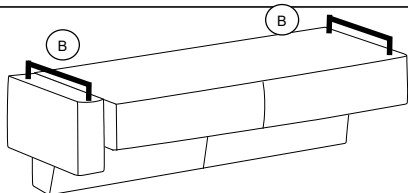

3-Sitzer mit AL. Links/rechts (SR 90)

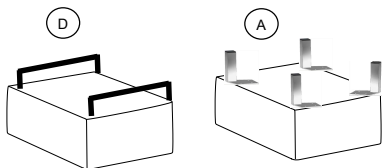

Hocker

Metallfuß Longchair hinten

Metallfuß 382 Chrom glänzend h - 20cm
Metallfuß 384 schwarz matt h - 20cm



Montage

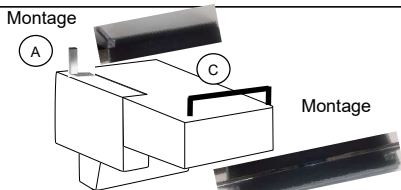

Longchair mit Armlehne li./re. (SR 90)

Metallkufe

Metallkufe 376 Chrom glänzend h - 20cm
Metallkufe 380 schwarz matt h - 20cm

Metallkufe Longchair vorne

Metallkufe 453 Chrom glänzend h - 20cm
Metallkufe 452 schwarz matt h - 20cm

Metallkufe Hocker

Metallkufe 786 Chrom glänzend h - 20cm
Metallkufe 785 schwarz matt h - 20cm

(A) Höhe 20cm	(B) Höhe 20cm	(C) Höhe 20cm	(D) Höhe 20cm	(E)	(F)	Modellnummer
						35049
Metallfuß	Metallkufe	Metallfuß	Metallfuß			Stand
Kundenseitig	Kundenseitig	Kundenseitig	Kundenseitig			09.05.2023
						Revision
						01
						Verfasser
						RSZ

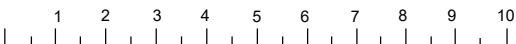

30.11.2011

Stand

00

Revision

VHÖ

Verfasser

1 / 1

Seite(n)

Kopfteilfunktion

Bezeichnung

FOB_BE_0009

lfd. Nr.

1

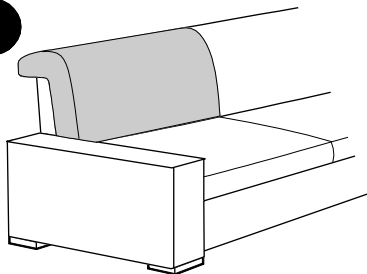

2

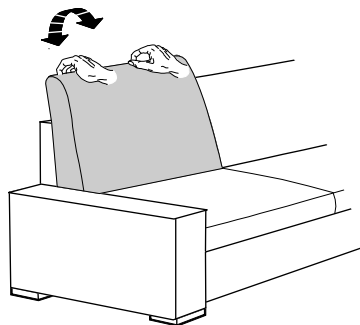

30.09.2020

Stand

01

Revision

MVI

Verfasser

1 / 1

Seite(n)

Rückentiefenverstellung man./Schwenkrücken

Bezeichnung

FOB_BE_0011

lfd. Nr.

1

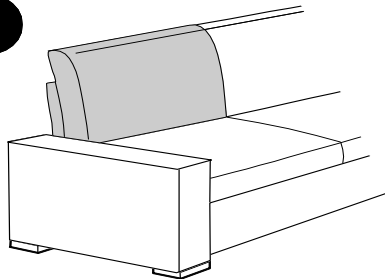

2

