

980423

1.

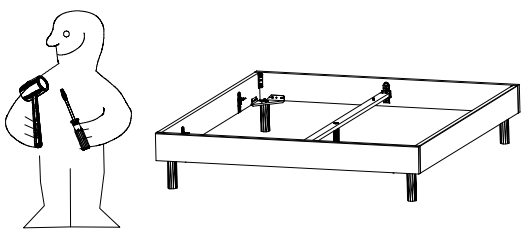

2.

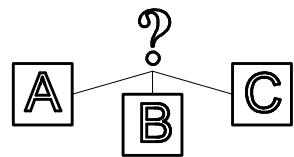
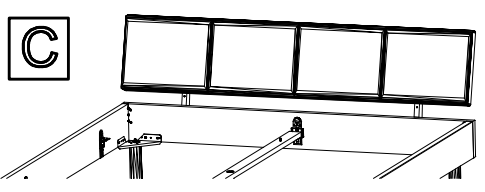
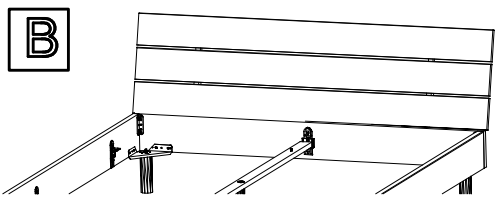
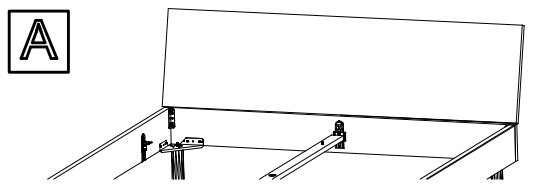
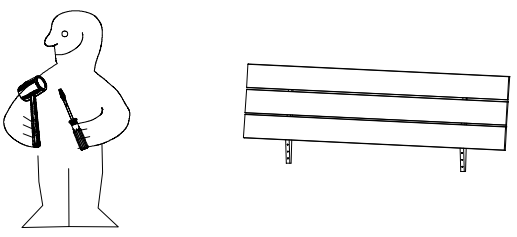

A

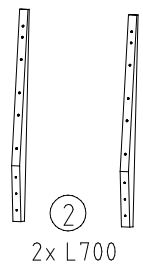
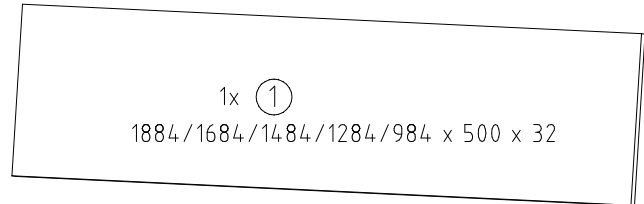

B

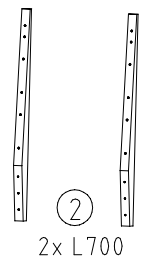
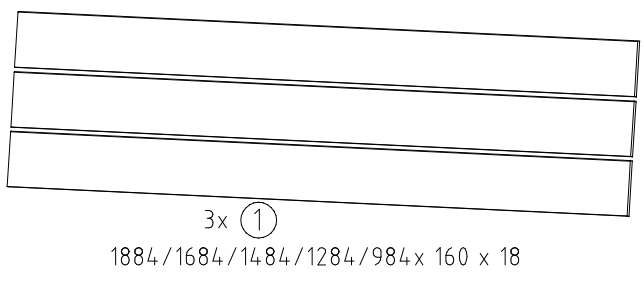

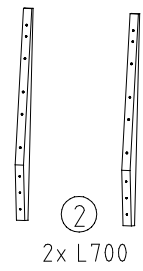
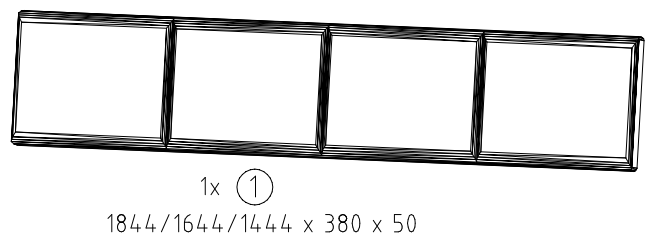

C

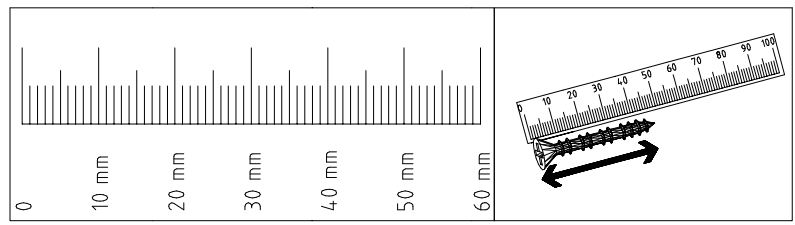
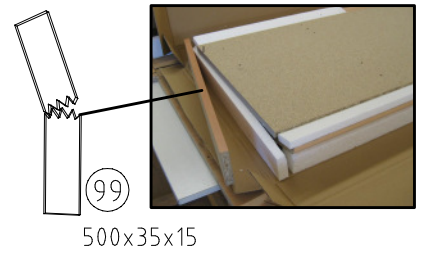
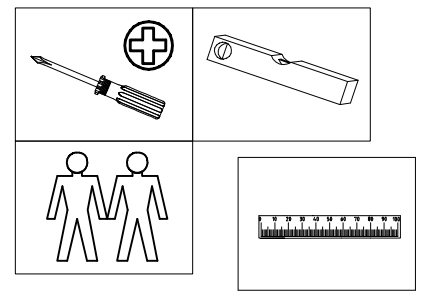

o16	A	B
	2x	
111 004 4,0 x 15 mm	A	B
G23	8x	
121 110		
121 115	SP40	
	6x	
4 X 40 mm		
4 X 27mm	A	B
SP27	6x	12x10x
122620		

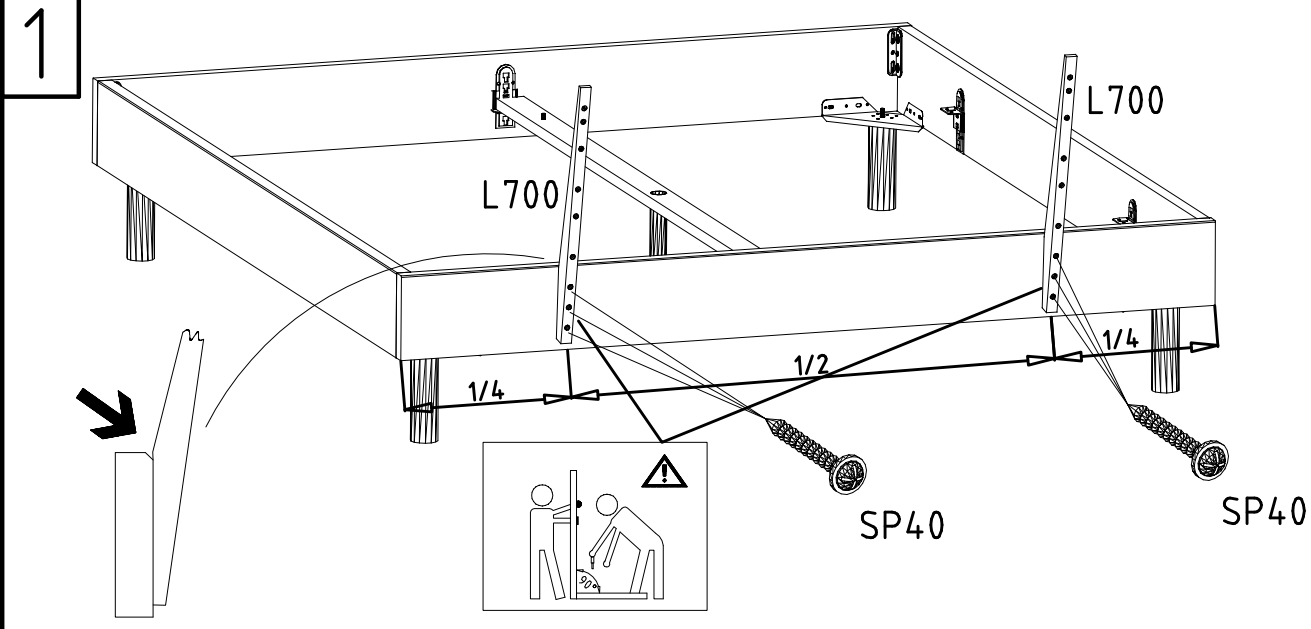



121 115 **SP40**

 4 X 40 mm

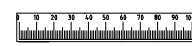

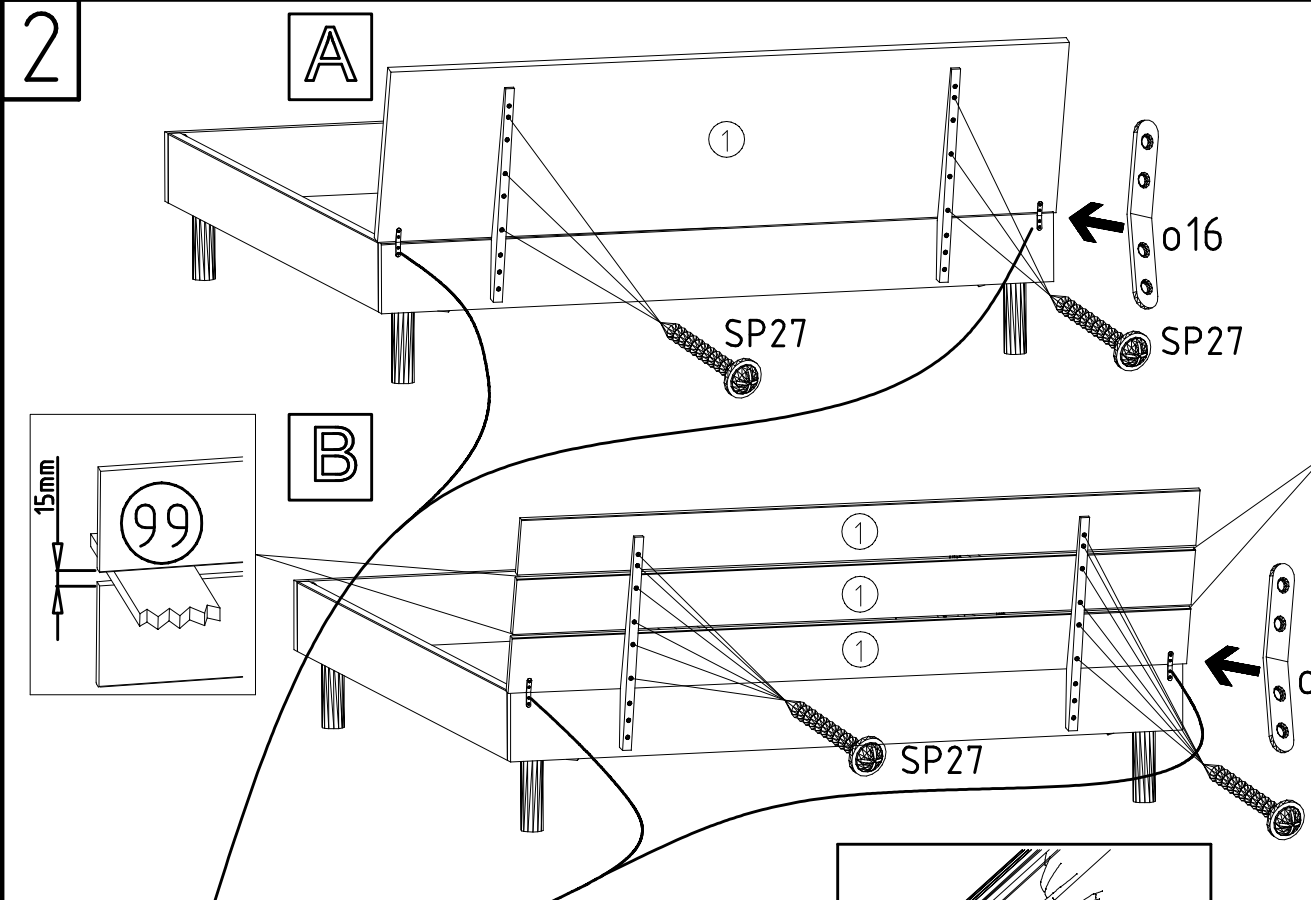

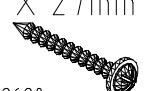

SP27
 4 X 27mm

 122620

