

A	B	C1	C2	C3	D
1	M233-2007	980	30	28	1/1
2	M233-4501	880	958	19	1/1

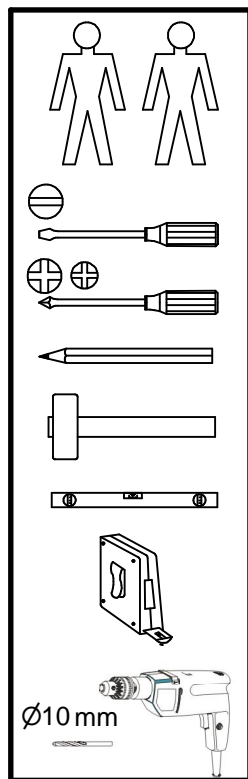

Ø10 mm

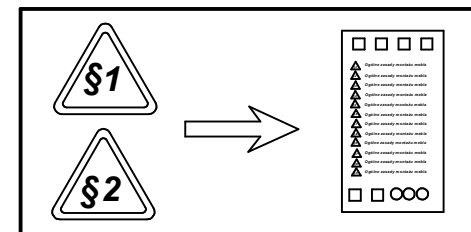
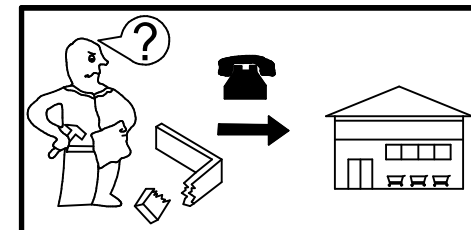
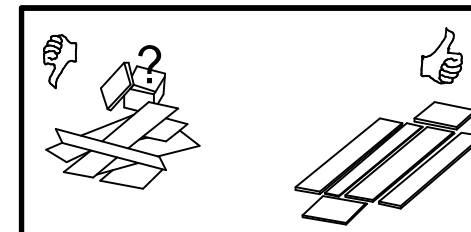
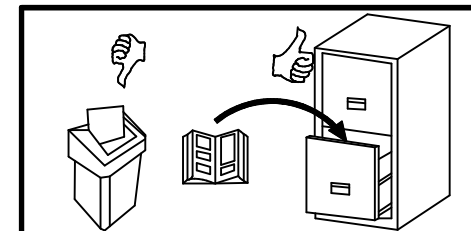
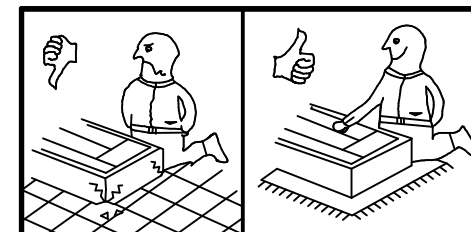
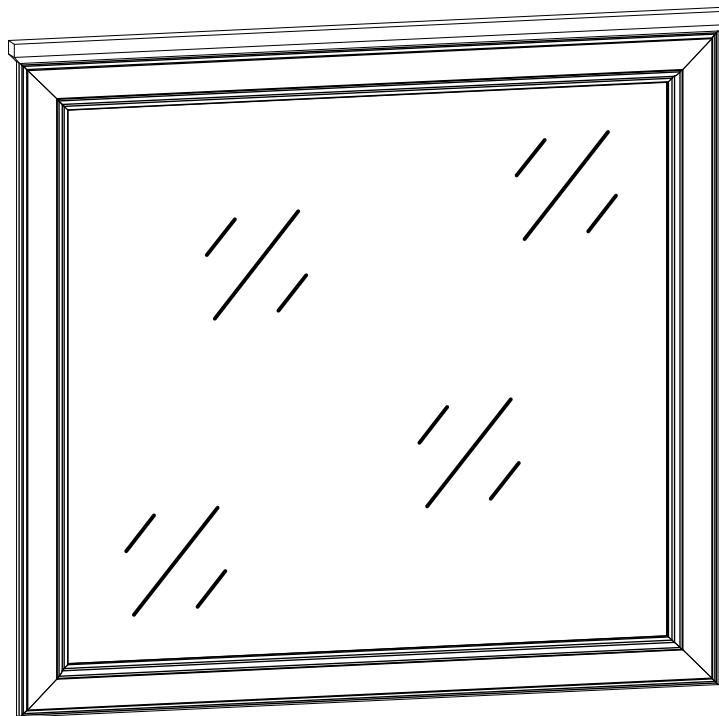
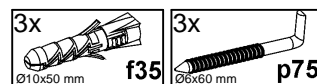
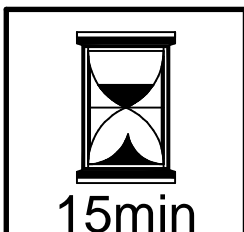

1 



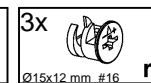
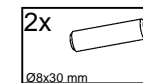
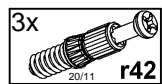
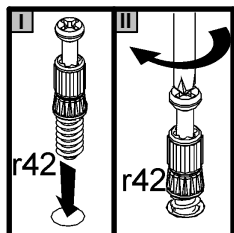
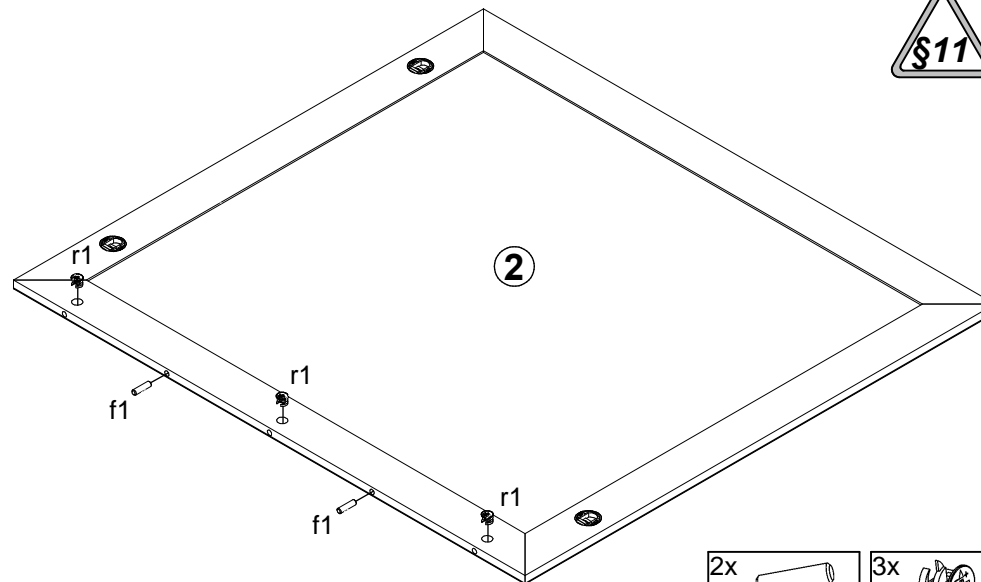
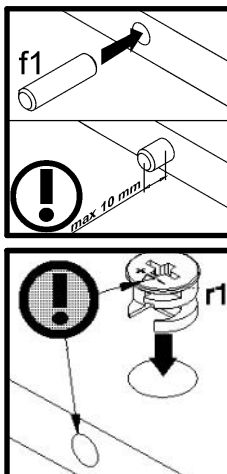
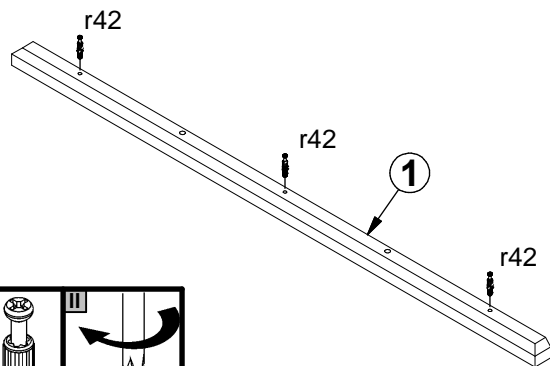



2

