



**T1** Bitte unbedingt ausfüllen!

Name	
Strasse	
PLZ	Ort
Tel.	

**T2** Sehr geehrte Kunden,  
 wir freuen uns, dass Sie sich für ein Produkt aus dem Hause Pelipal entschieden haben. Sollte es trotz aller Bemühungen unsererseits, Ihnen ein qualitativ hochwertiges Möbelstück zu liefern, zu Fehlteilen kommen, schicken Sie bitte dieses ausgefüllte Blatt an  
 Fax.: **+49 3443/434350**  
 E-Mail: **ersatzteile@pelipal.de**  
 Bitte beachten Sie, dass Bauteile über 800mm Länge und 350mm Breite direkt bei Ihrem Möbelhändler zu beanstanden sind. Zur Reklamationsbearbeitung ist es unbedingt erforderlich **die Artikelnummer des Schrankes**, welche auf dem Etikett ersichtlich ist und den Markt, wo das Möbel erworben wurde anzugeben. Ausserdem tragen Sie unten bitte die benötigte Stückzahl ein. Viel Spass mit Ihrem neuen Badmöbel! Ihr Pelipal Team

-
---

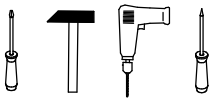

**T3** Für den Zusammenbau sind 2 Personen erforderlich.

**T4** Montage-Richtzeit 3 Stunden

20 x a  DUEB-SMD-000005	Stück	16 x b  EXZENTER-000015	Stück	4 x c  TBD-26-115X00	Stück	4 x d  ZPL-016X000	Stück	16 x e  TRAE-002-000010	Stück
2 x f  KA-200-1730			Stück	2 x g  SCH-KA-M04X009		Stück		Stück	Stück
1 x j  AUF-001-000080	Stück	1 x k  AUF-001-000090	Stück	12 x l  SCH-SPA-035X015	Stück	4 x m  SCH-KA-063X010	Stück	20 x n  NAGEL-025X001	Stück
3 x p  Griff	Stück	6 x r  EXZENTER-000014	Stück	2 x s  AUF-001-000020	Stück	4 x t  EXZENTER-000014	Stück	2 x v  TUER-DAEM-000010	Stück
2 x w  TUER-ADA-000010	Stück	2 x x  FSS-EF-CRG100E-311	Stück	8 x y  SCH-SPA-035X020	Stück	4 x z  ADK-AL1-005X008	Stück	1 x α  VBD-000020	Stück
1 x β  SCH-RDK-045X045	Stück	1 x γ  SCH-RDK-040X015	Stück						

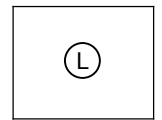
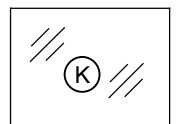
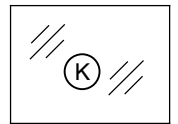
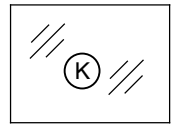
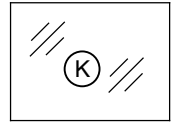
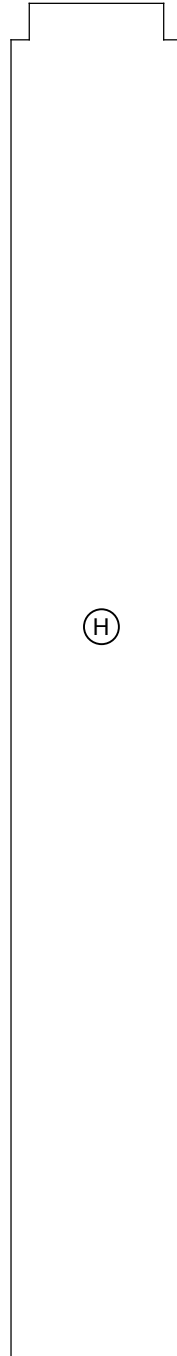
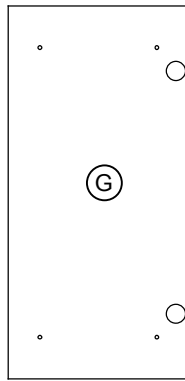
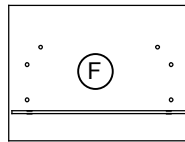
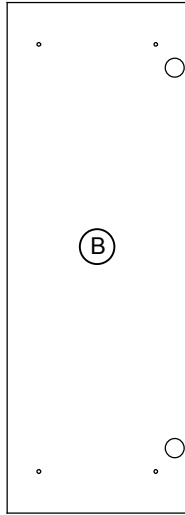
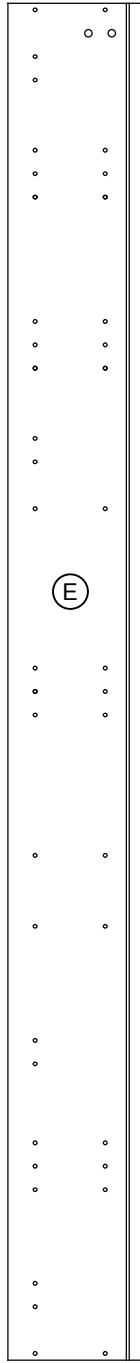
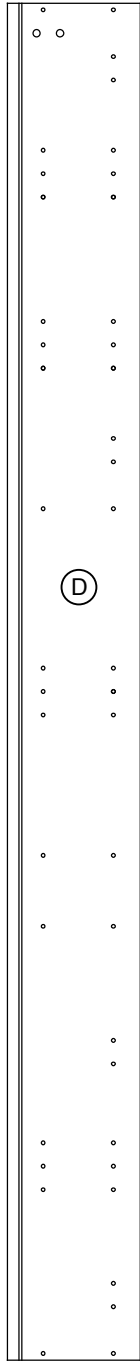
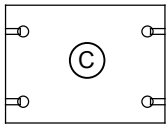
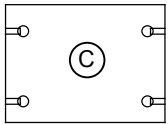
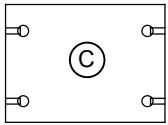
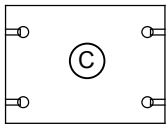
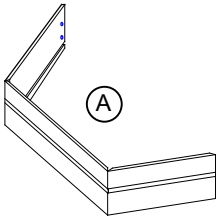

1.

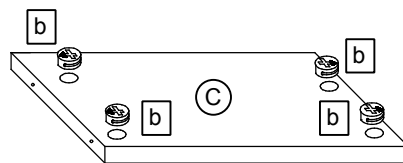
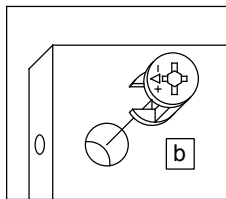

2.

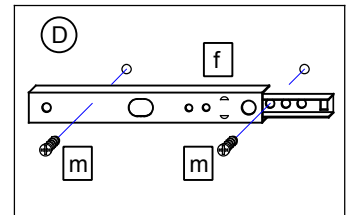
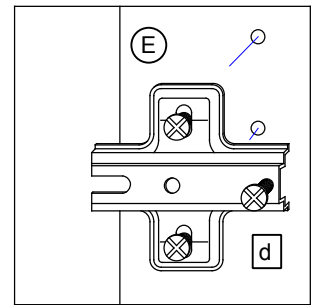
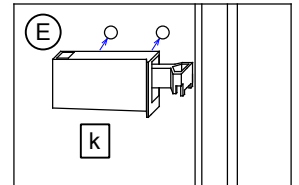
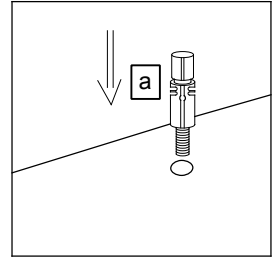
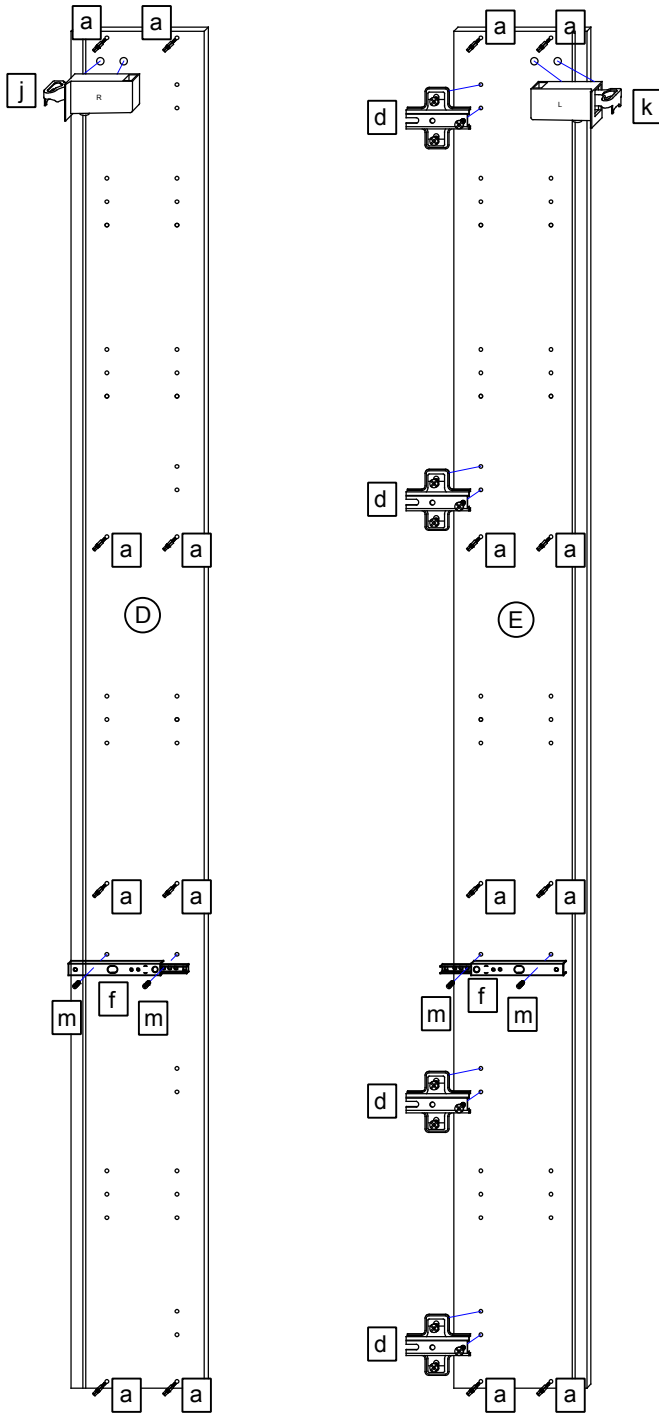
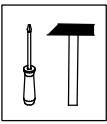

3.

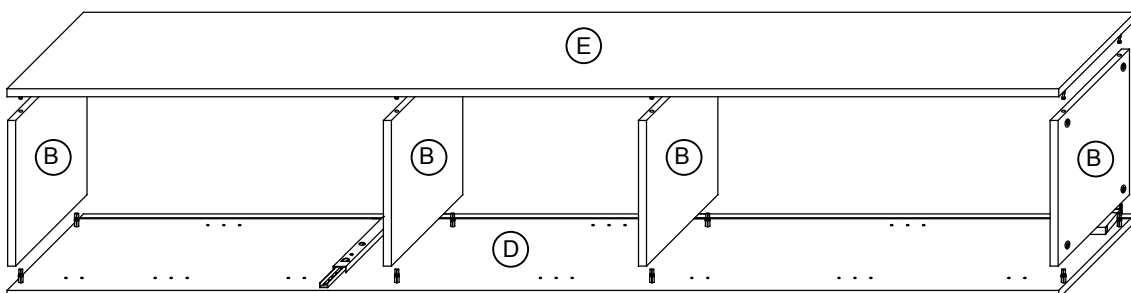
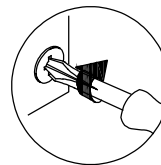
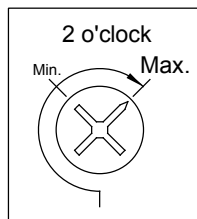
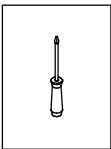

4.

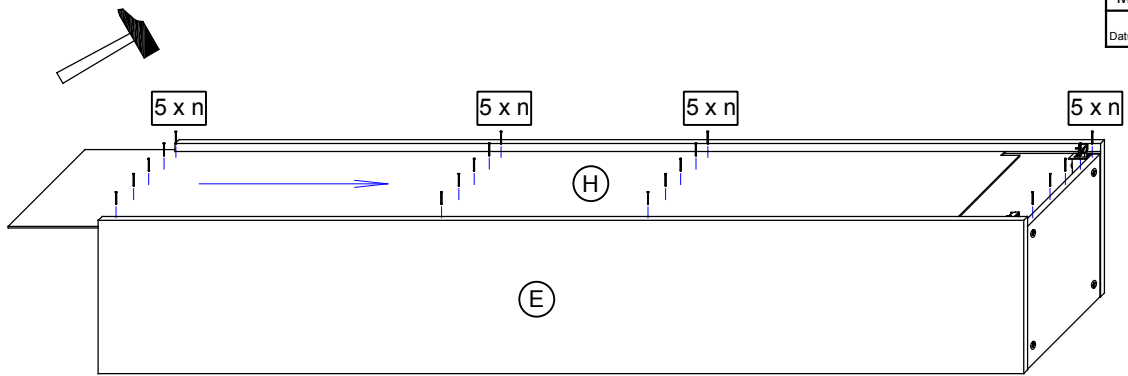
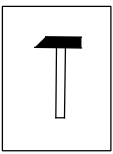

5.

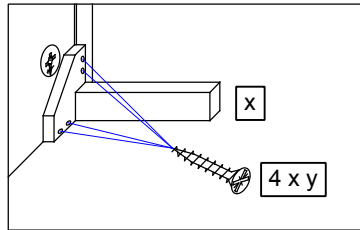
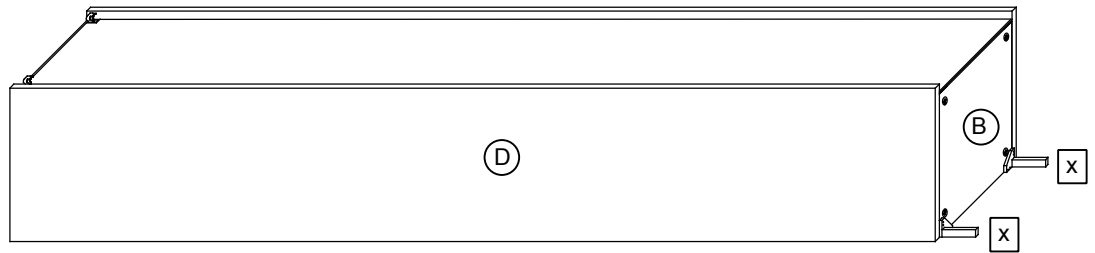
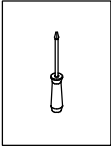

6.

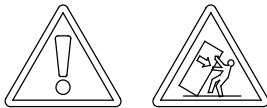
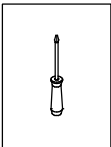

- T6** Die Schrankaufhänger dienen zur Kippsicherung des Schrankes und müssen grundsätzlich montiert werden.
- T9** Lassen Sie den Schrank nur durch fachkundige Personen mit für die Wand geeignetem Montagematerialien montieren.

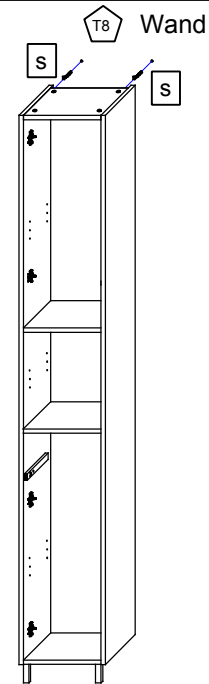

7.

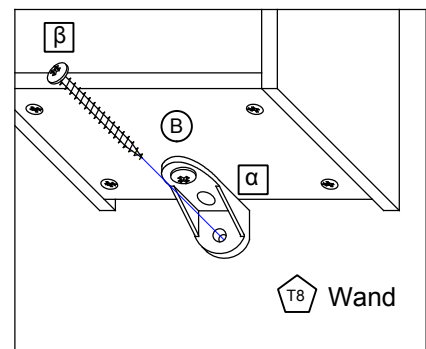
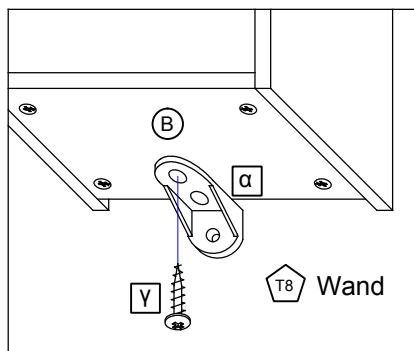
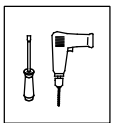

8.

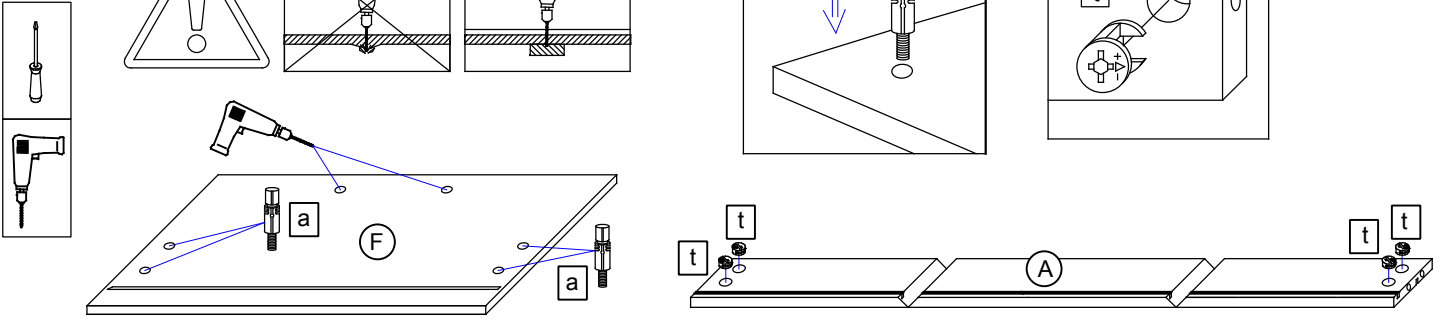

9.

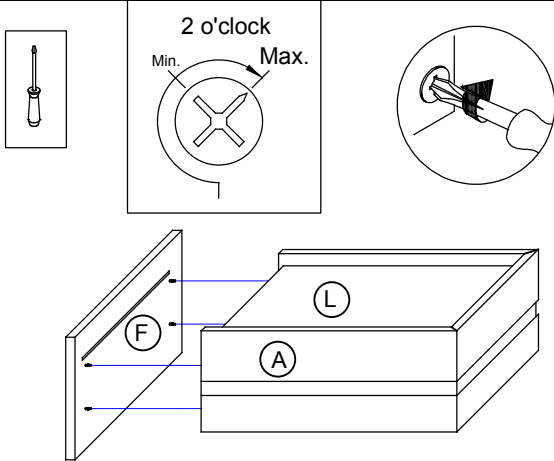

10.

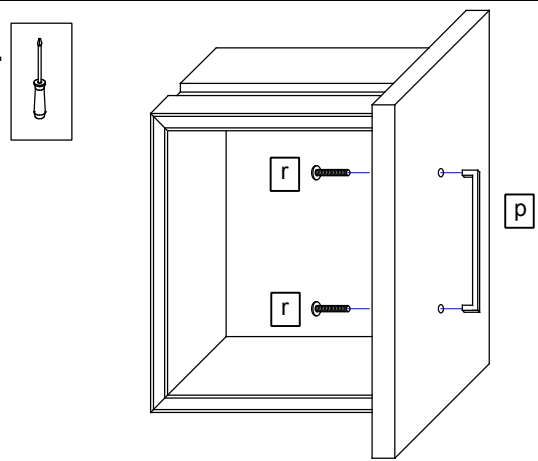

11.

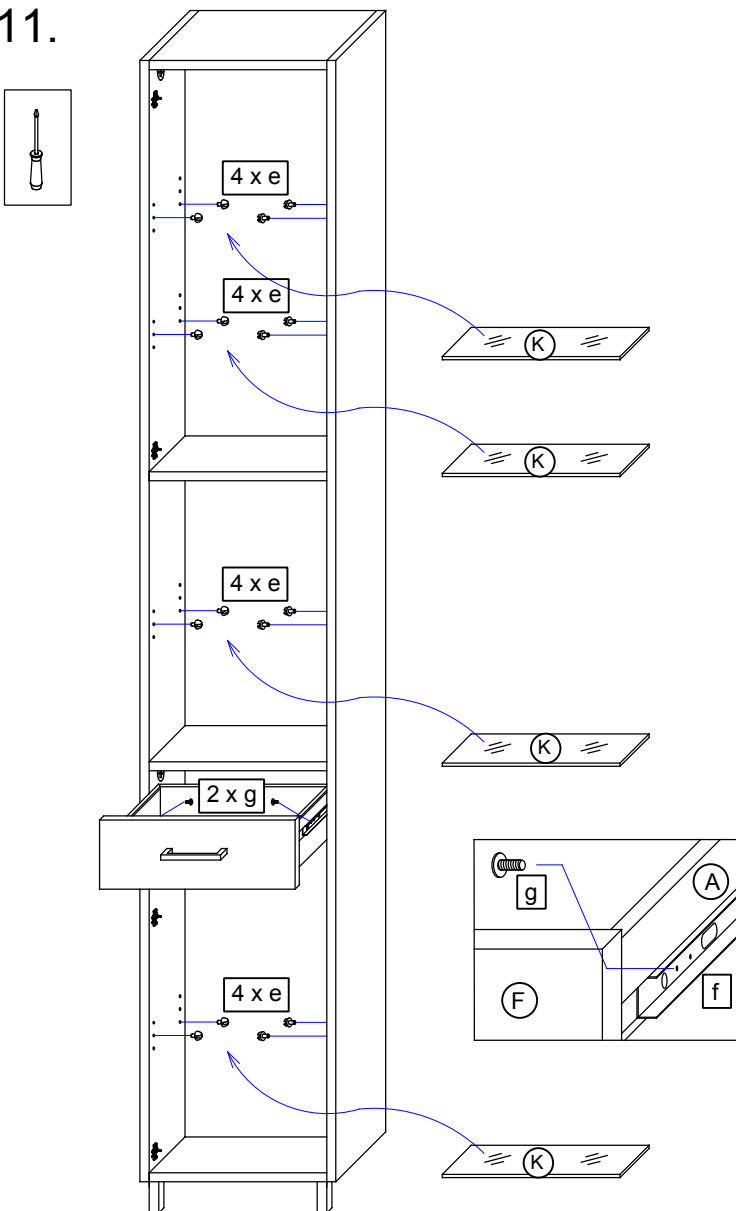

12.

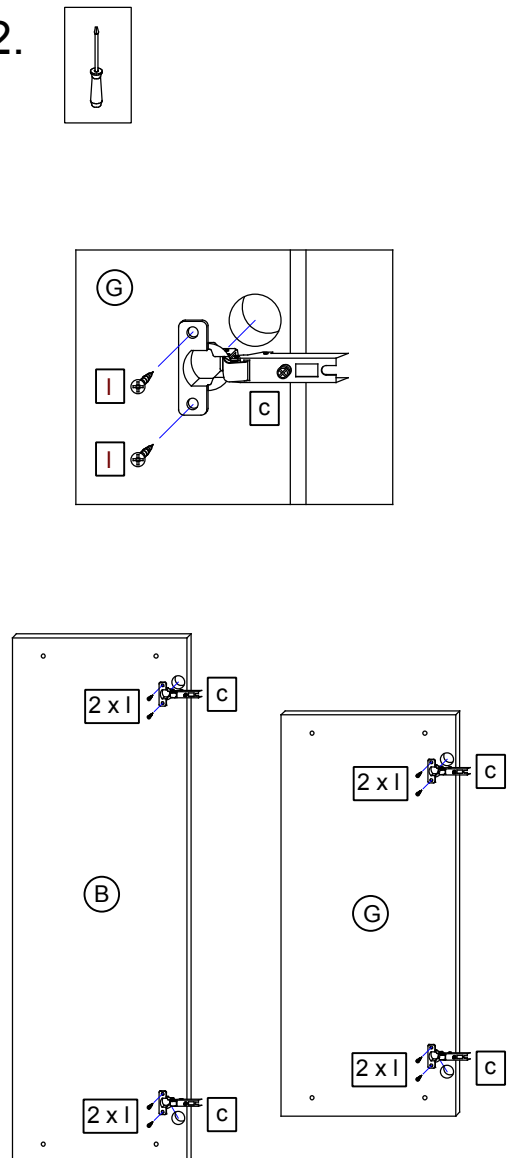

13.

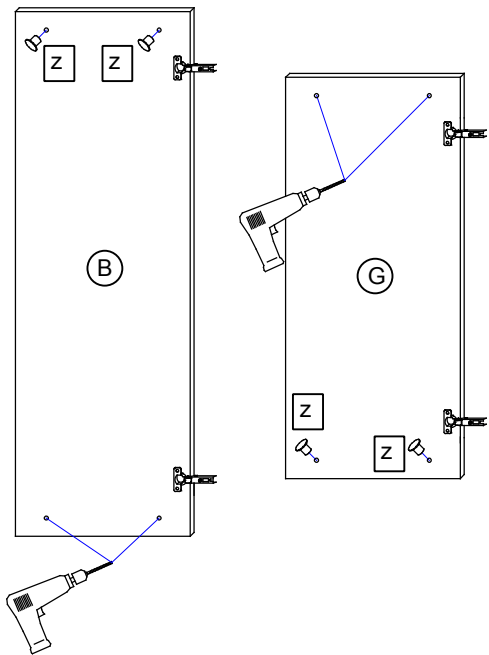
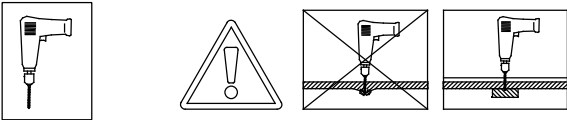

14.

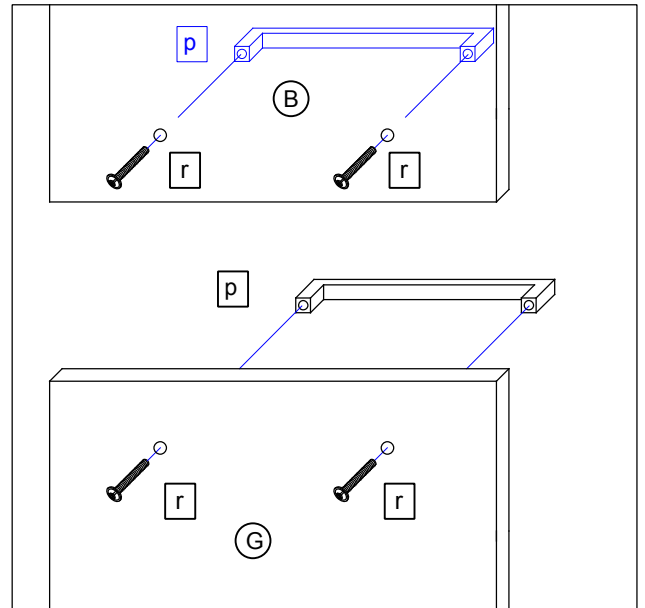
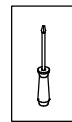

15.

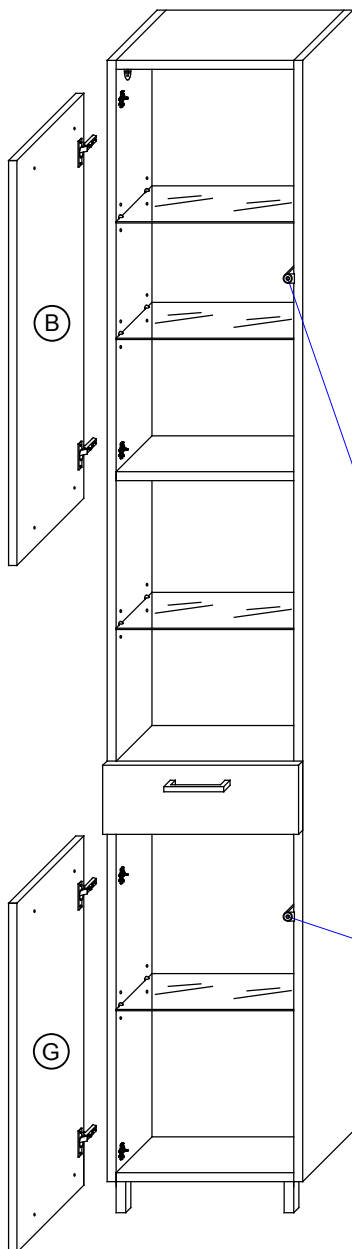
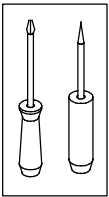

T11 Bei Türmontage das Scharnier einhängen, bis Anschlag öffnen und anschließend festschrauben.

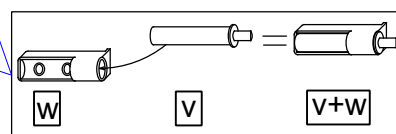
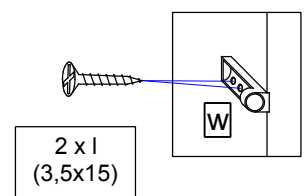
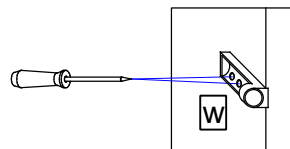
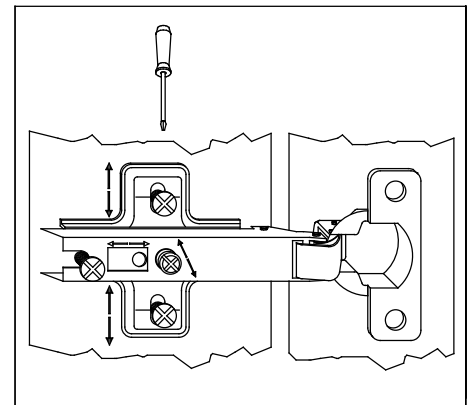
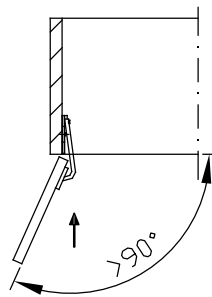

T12 Das Möbel bitte nur mit einem feuchten Tuch reinigen.