

GABRIEL 320

84-223-...-

respekta

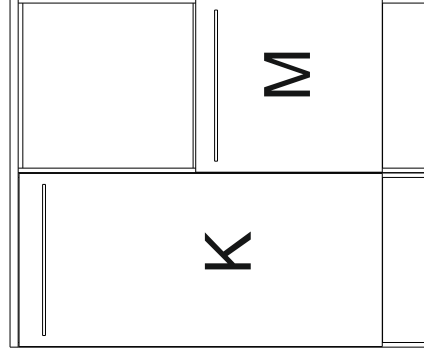
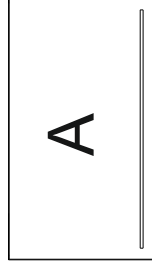

K M

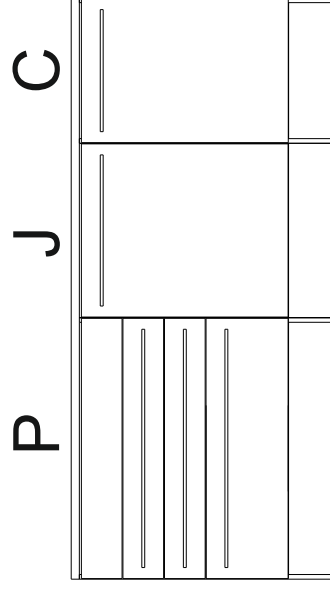

300 min

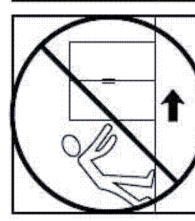
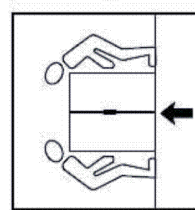
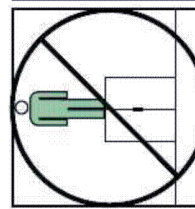
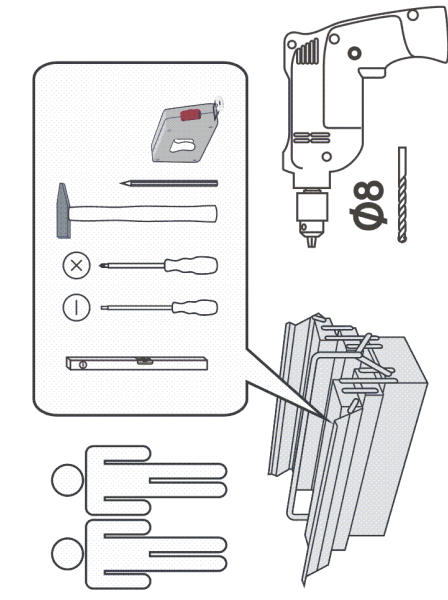
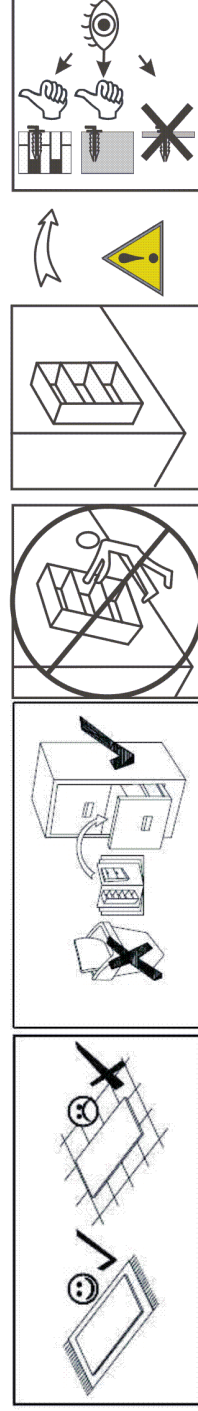

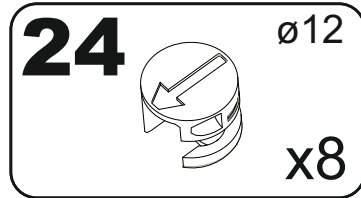
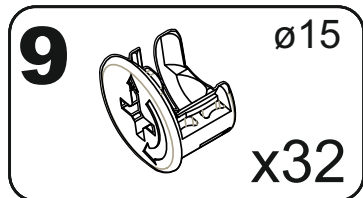
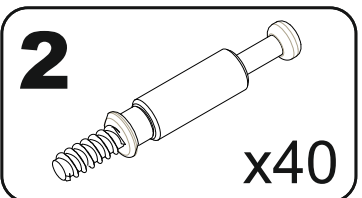
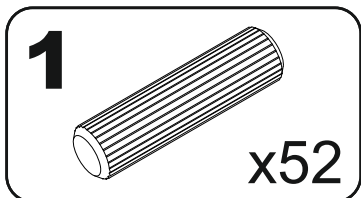
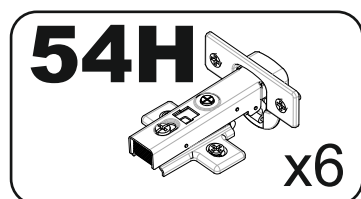
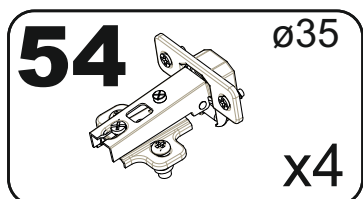
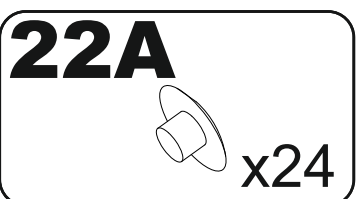
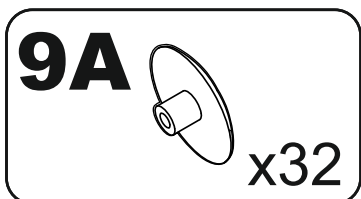
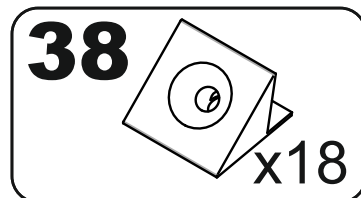
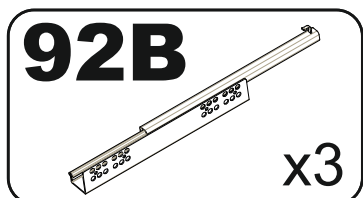
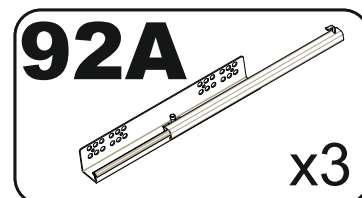
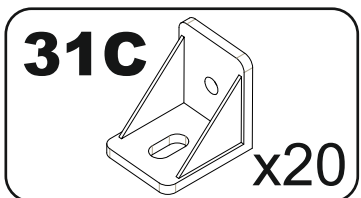
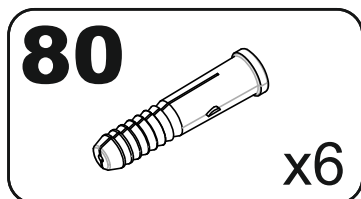
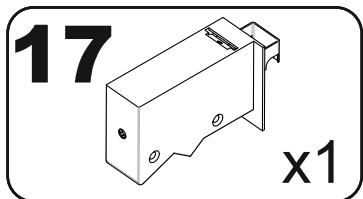
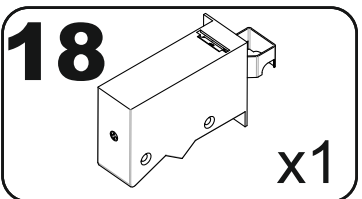
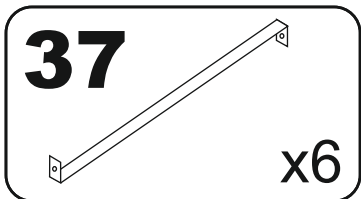
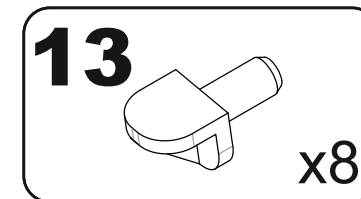
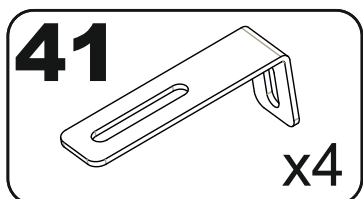
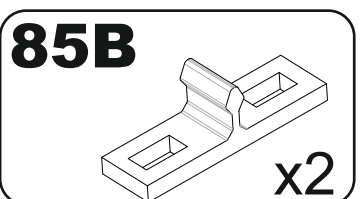
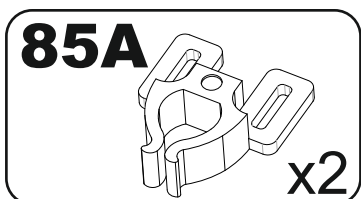
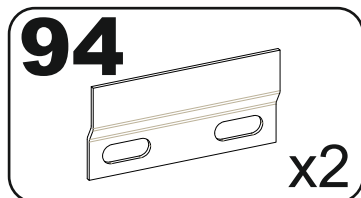
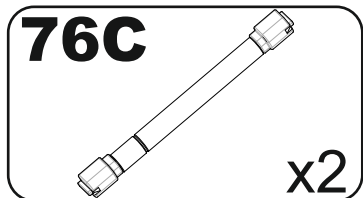
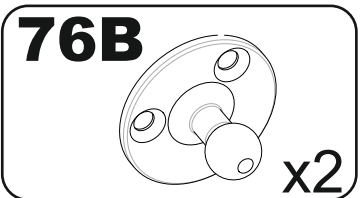
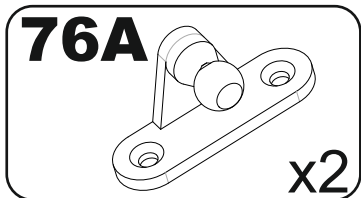
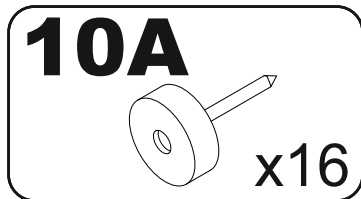
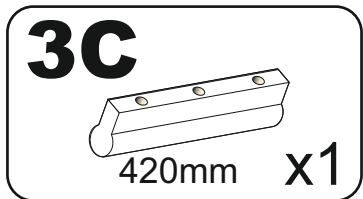
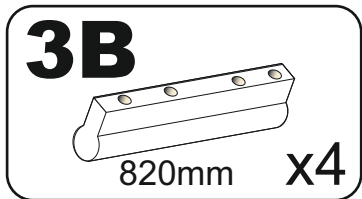
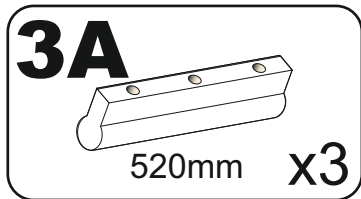
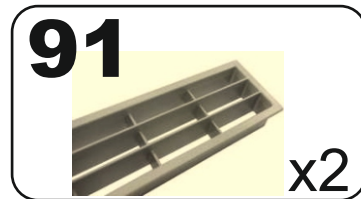
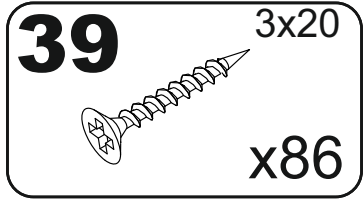
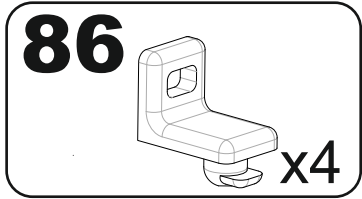
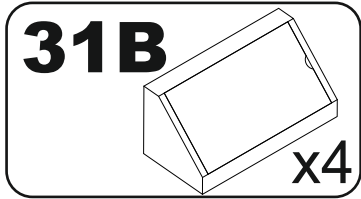
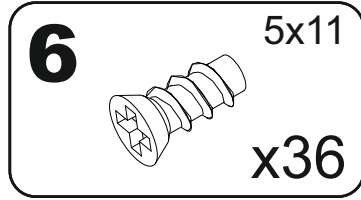
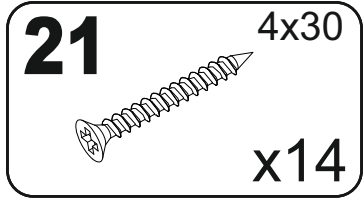
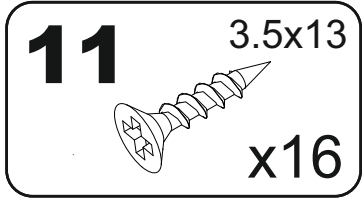
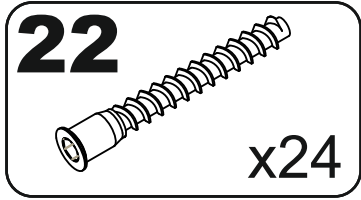
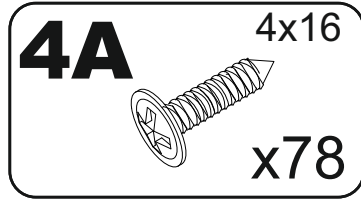
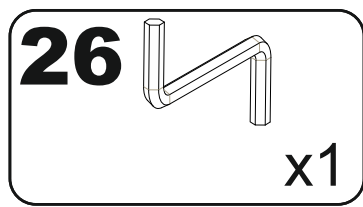
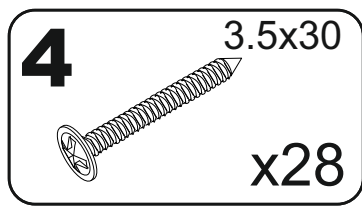
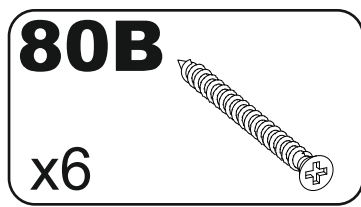

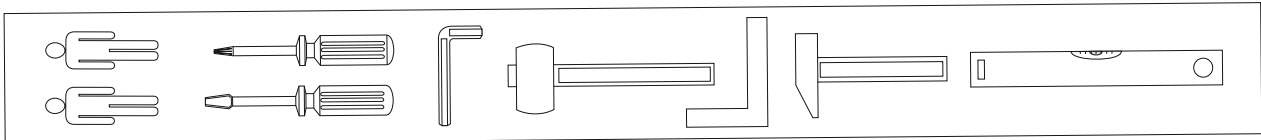

XXXXXXXXXXXXX
serie: xxx
.....
.....
.....
Hergestellt für:
.....
.....

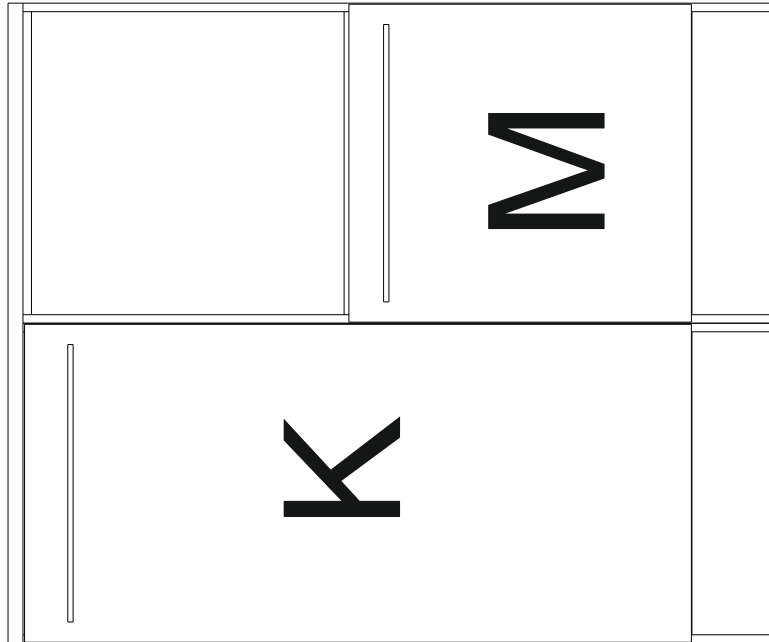
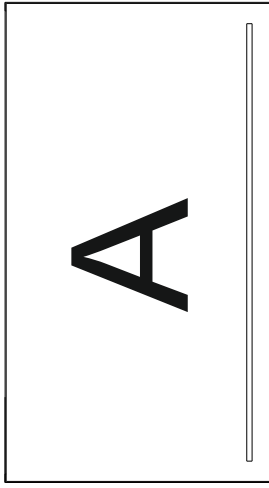
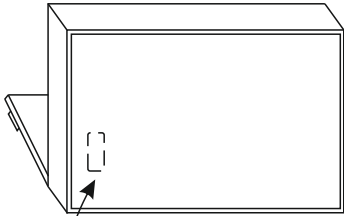

P

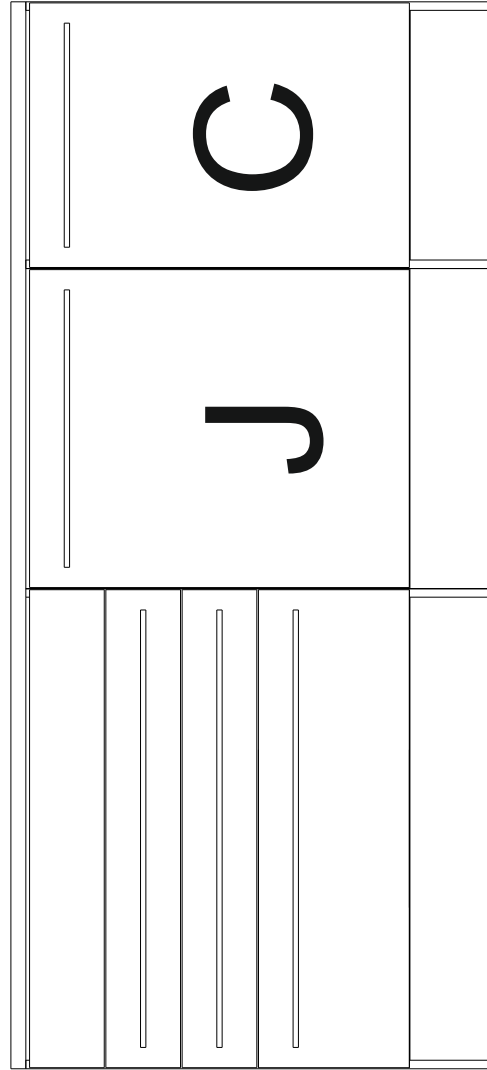

Erst wenn alles exakt steht, verbinden Sie die einzelnen Schränke mit Schrauben. Damit dabei nichts verrutscht, empfehlen wir Ihnen dringend den Einsatz von zwei Schraubzwingen. Die Schrankoberflächen schützen Sie mit Zulagehölzern vor Eindrücken.

Ermitteln Sie durch exaktes Messen die Positionen der Bohrungen für die Hängebeschläge

Legen Sie die Arbeitsplatte auf die Korpusse, richten Sie sie aus, und fixieren Sie sie mit Zwingen. markieren Sie die Lage und -breite des Herdunterschrankes.

Auf der Unterseite der Arbeitsplatte reißen Sie im markierten Bereich den Herdplattenausschnitt auf. Mitteln Sie sie aus, so dass die Spüle mittig im Unterschrank sitzt und vorne und hinten die Plattenrestbreite gleich wird.



Empfohlenes Vorgehen bei der Küchenmontage:

Bohren Sie in den vier Ecken jeweils ein 10-mm-Loch zum leichteren Einsetzen der Stichsäge, und schneiden Sie den Herdausschnitt entlang Ihrer Risse aus. Arbeiten Sie immer von der Plattenunterseite, damit die Plattenoberfläche durch die Stichsäge nicht ausfasert. Schalten Sie dazu auch den Pendelhub an Ihrer Stichsäge, sofern vorhanden, aus.

Zum Schutz der Holzteile können Sie rundum die Sockelteile eine Silikonnaht ziehen



Empfohlenes Vorgehen bei der Küchenmontage:

Bohren Sie in den vier Ecken jeweils ein 10-mm-Loch zum leichteren Einsetzen der Stichsäge, und schneiden Sie den Herdausschnitt entlang Ihrer Risse aus. Arbeiten Sie immer von der Plattenunterseite, damit die Plattenoberfläche durch die Stichsäge nicht ausfasert. Schalten Sie dazu auch den Pendelhub an Ihrer Stichsäge, sofern vorhanden, aus.

Zum Schutz der Holzteile können Sie rundum die Sockelteile eine Silikonnaht ziehen



Allgemeine Hinweise

Die Montage einer Einbauküche sollte von entsprechend geschulten Fachkräften durchgeführt werden. Vor der Montage müssen die Montagehinweise gelesen werden.

Spezielle, weiterführende Montageanleitungen und Hinweise liegen den Geräten, Spülen, Beleuchtungen und Sonderausstattungen bei und müssen zusätzlich beachtet werden.

Für die Befestigung von Wandhängeelemente gilt:



Wir legen kein Befestigungsmaterial bei. Bitte prüfen Sie die gegebene Wandbeschaffenheit und wenden Sie sich an den örtlichen Fachhandel zum Erwerb der passenden Dübel / Haken / Aufhängeschienen / Schrauben

Für die Aufhängung können entweder Haken oder Aufhängeschienen verwendet werden.



Die Hängeschränke können bei korrekter Montage mit ca. 40 kg belastet werden. Achten Sie auf eine gleichmäßige Lastverteilung

Bei Nichtbeachtung der Montagehinweise können wir entstandene Schäden keine Haftung übernehmen

Achten Sie darauf bei Einzelschränken, oder der gesamten Küchenzeile eine Kippsicherung anzubringen

Sanitär- und Elektroinstallationen dürfen nur von einer entsprechenden Fachkraft vorgenommen werden

Vor Bohrarbeiten muss geprüft werden, dass an der Stelle des Bohrens keine Leitungen für Gas, Wasser, Strom, Heizung oder

Abflüsse verlegt wurden

Es dürfen keine verändernden Manipulationen am Zubehör oder an Elektrogeräten vorgenommen werden. Dies gilt insbesondere für Befestigungsbohrungen.

Überprüfen Sie vor der Montage ob alle Anschlüsse vorhanden sind und fachgerecht ausgeführt wurden

Die Küche beinhaltet verschluckbare Kleinteile. Kinder unter 3 Jahre nicht ohne Beaufsichtigung lassen



Empfohlenes Vorgehen bei der Küchenmontage:

Planen Sie den genauen Montageort unter Berücksichtigung Ihrer Sanitär- und Elektroanschlüsse

Prüfen Sie ob Ihr Kühl- Gefriergerät Lüftungsauslässe im Sockelbereich bzw. im Bereich der Arbeitsplatte benötigt

Erwerben Sie ggf. passende Lüftungsgitter im Fachhandel und schneiden Sie den Sockel bzw. die Arbeitsplatten gemäß den Anweisungen des Geräteherstellers aus.

Legen Sie fest, ob Sie die Türen mit Rechts- oder Linksanschlag montieren wollen

Montieren Sie zunächst die Unterschränke und richten Sie diese mit einer Wasserwaage aus.

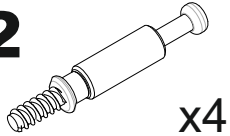
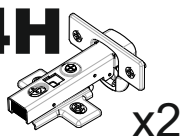
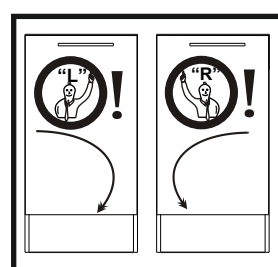
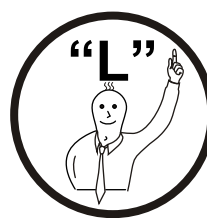
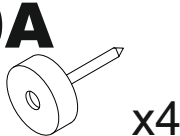

1**2****54H****10A****C**

C3 870x555

C4 870x555

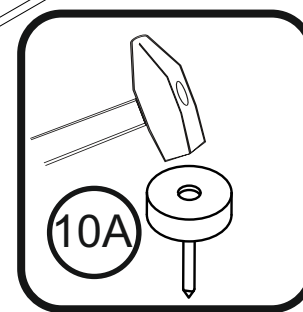
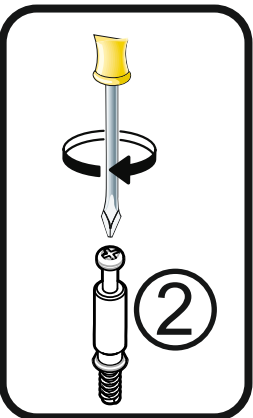
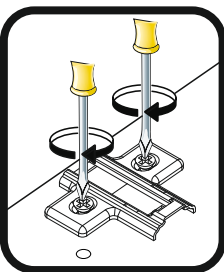
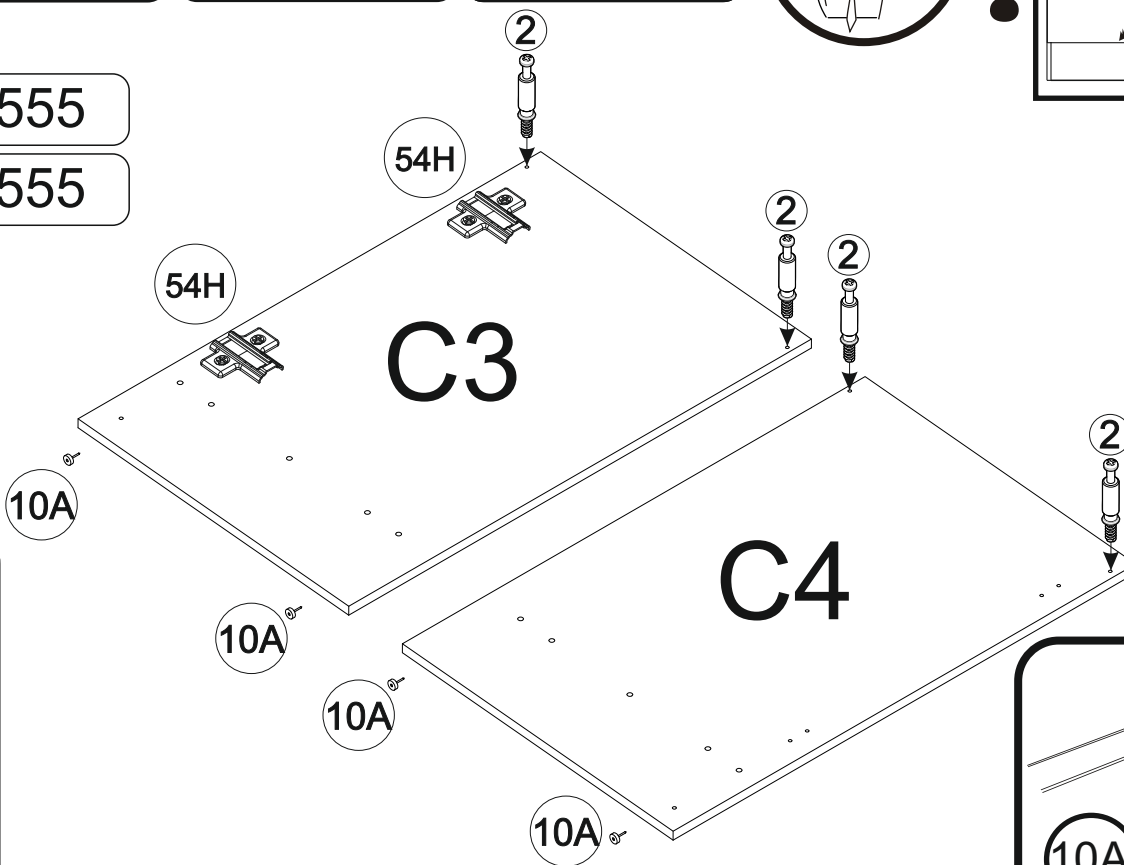
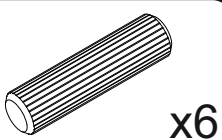
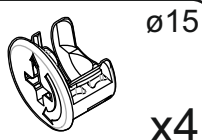
**2****1****9**

C1 467x535

C5 467x74

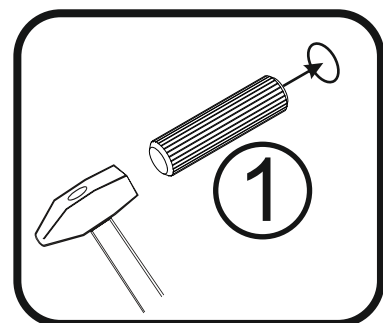
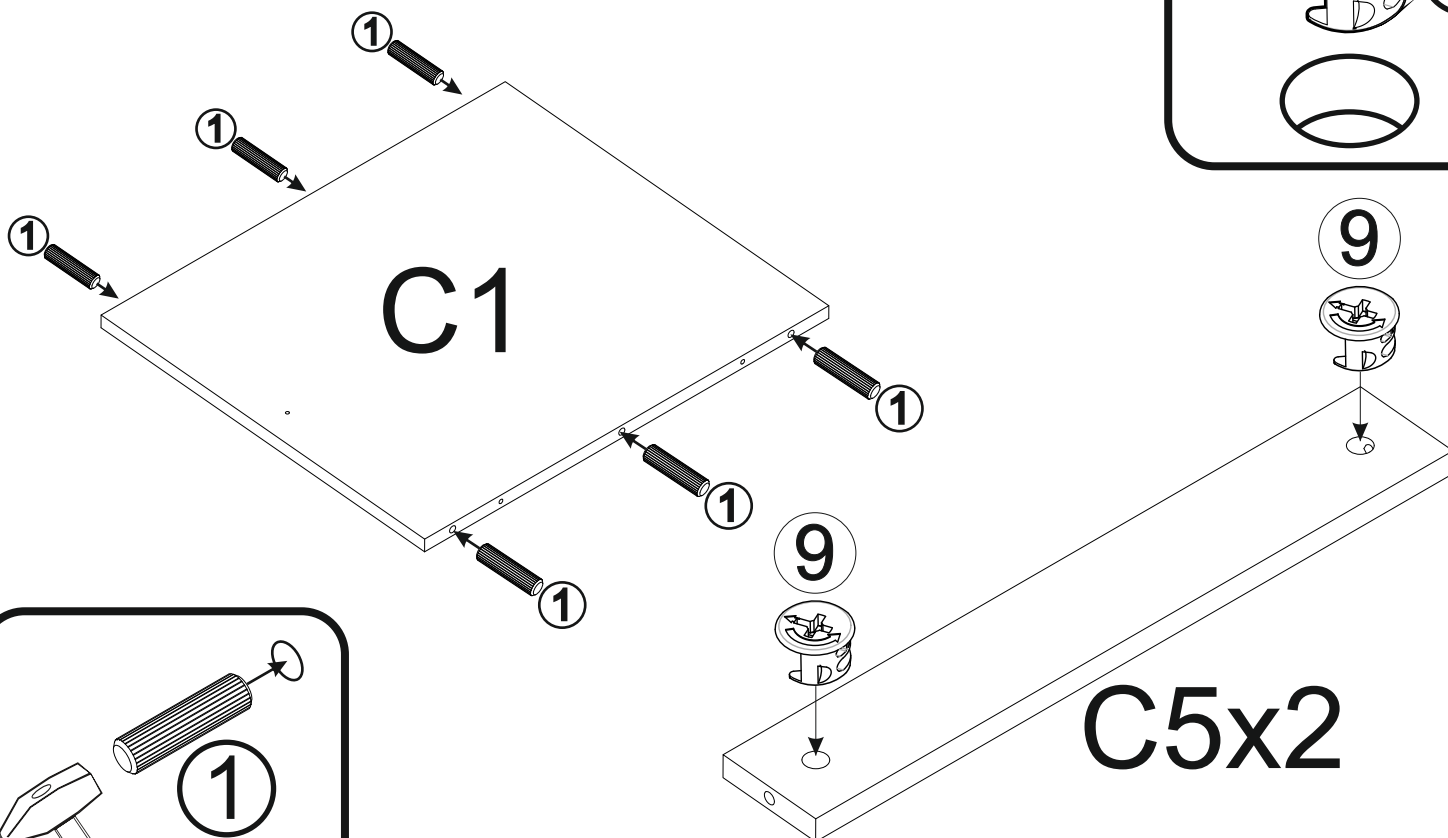
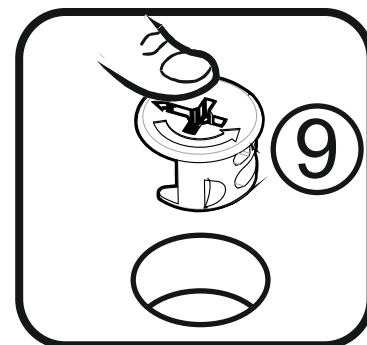
**C5x2**

3

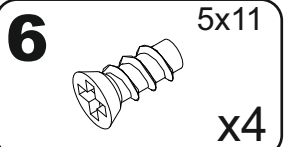
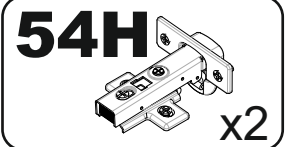

C6 713x496

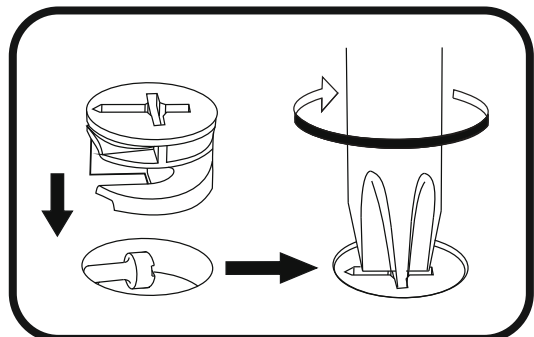
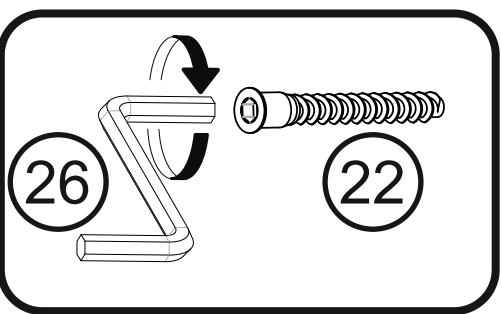
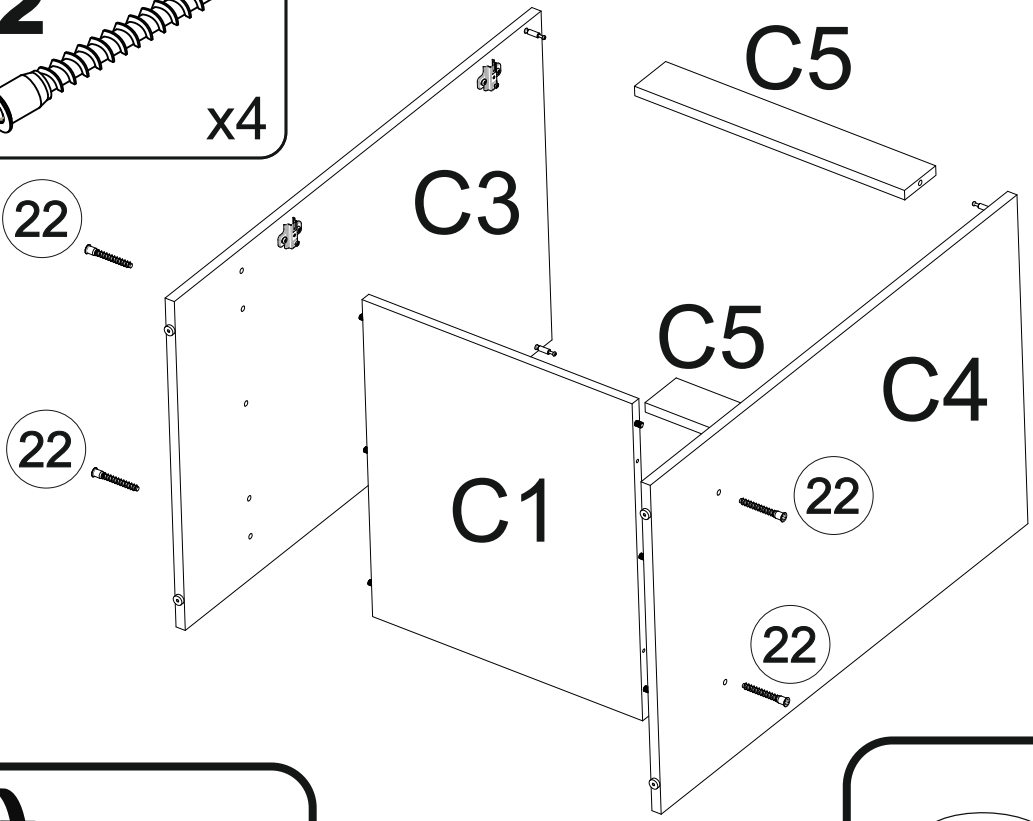
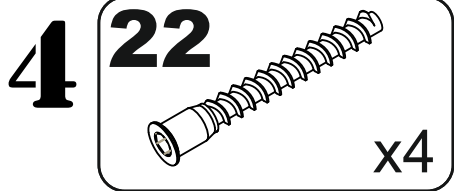
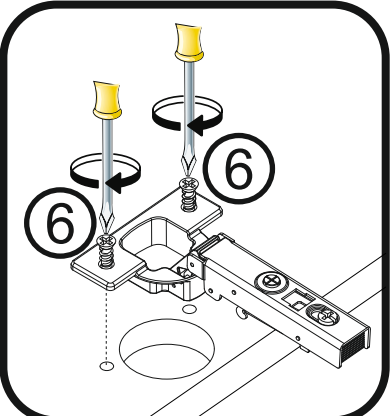
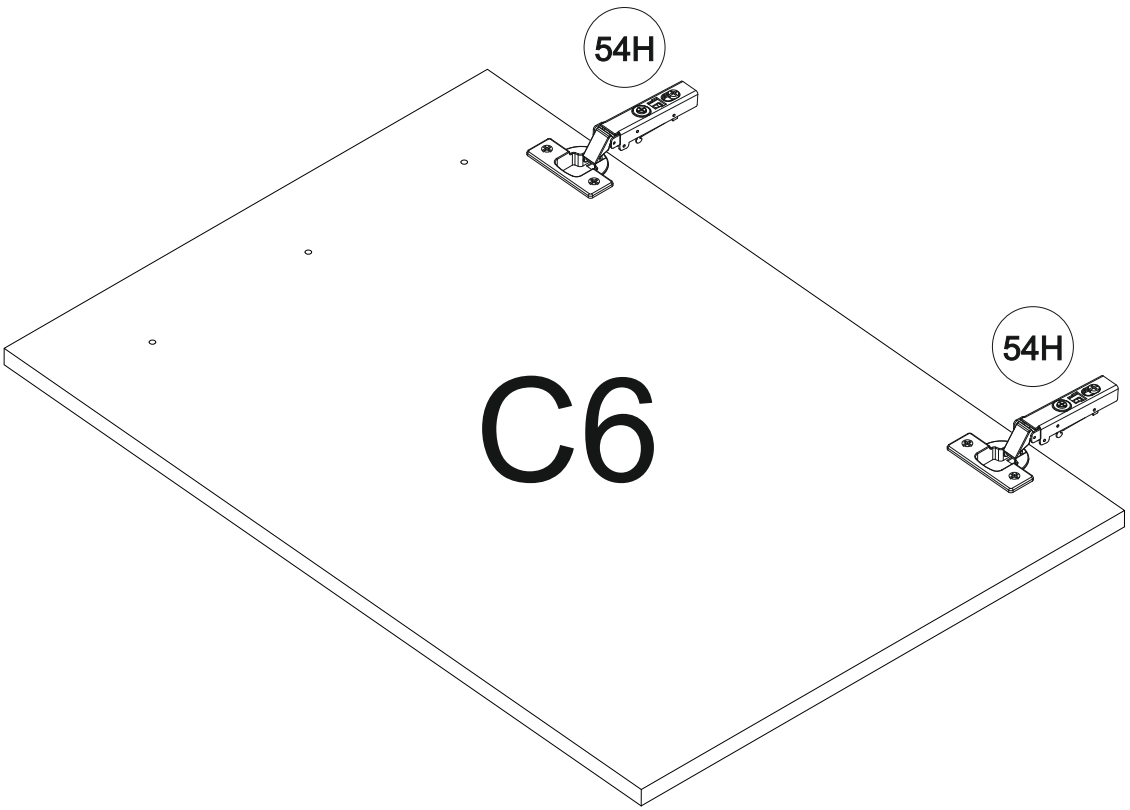

5

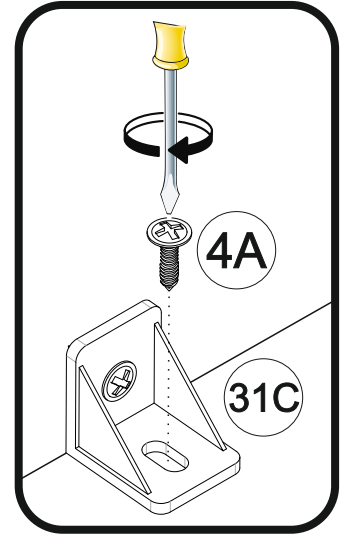
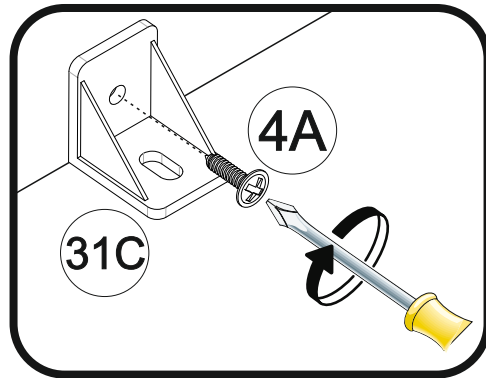
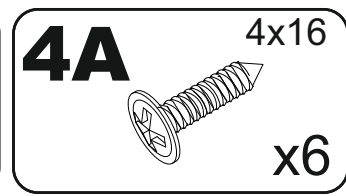
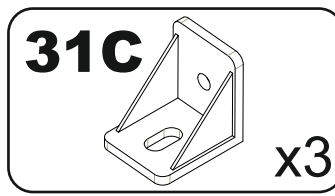
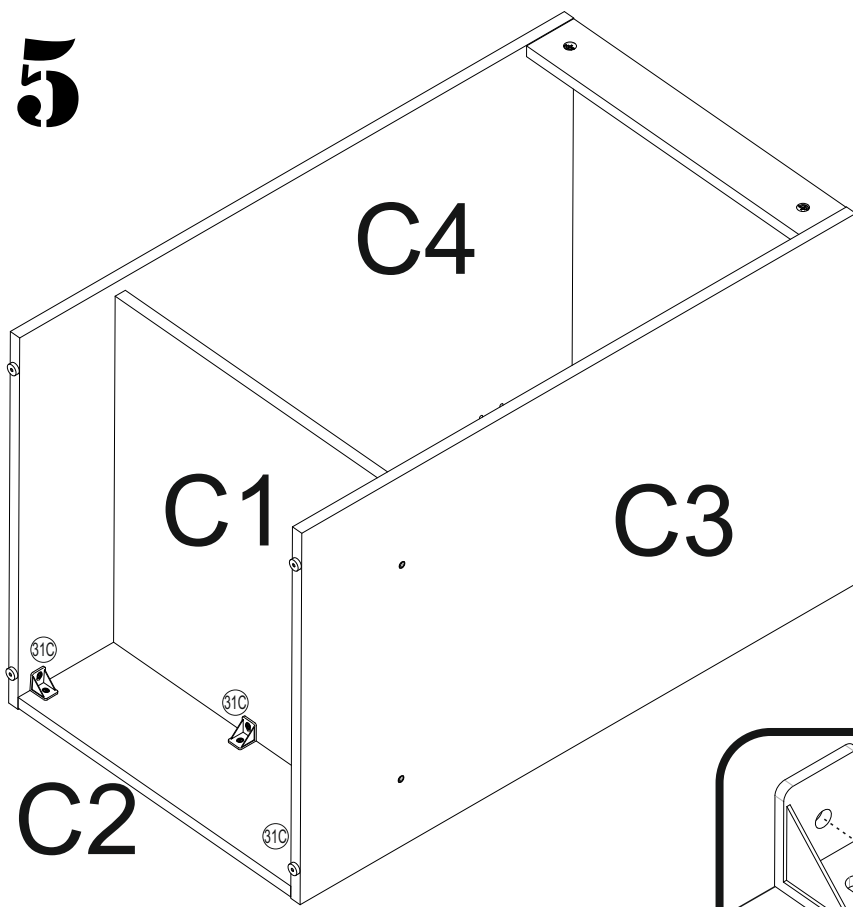

6

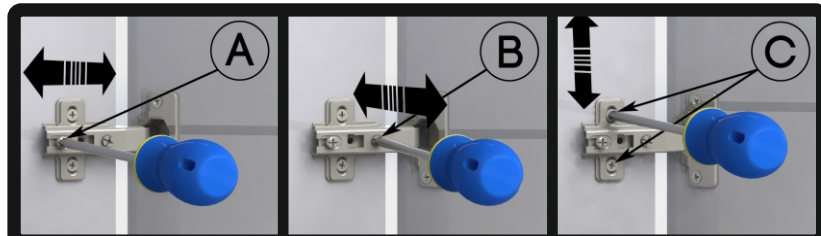
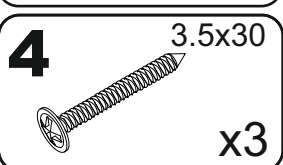
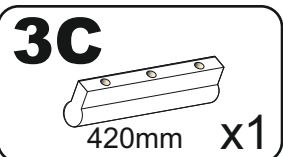
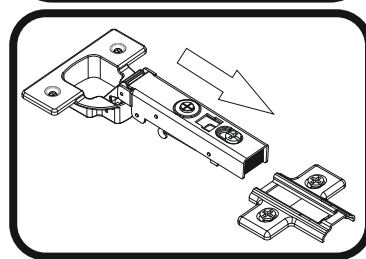
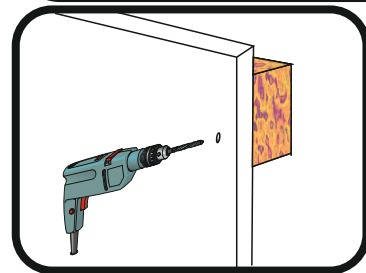
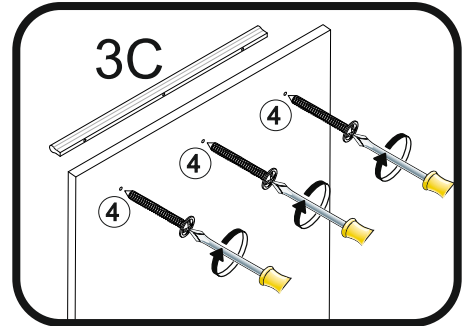
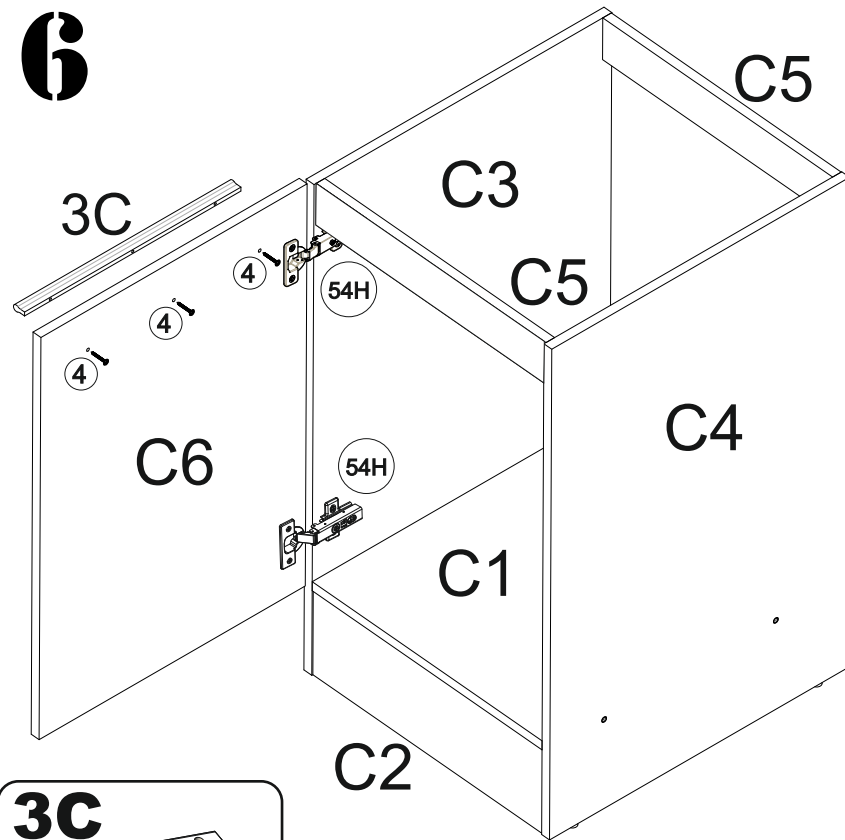

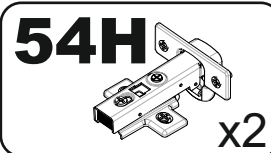
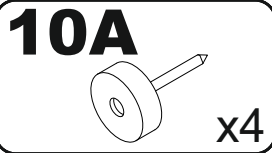
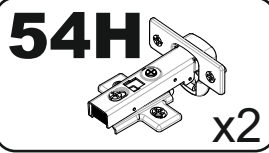
1

K3	1408x555
----	----------

K4	1408x555
----	----------

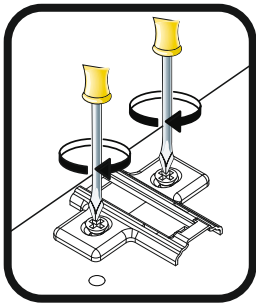
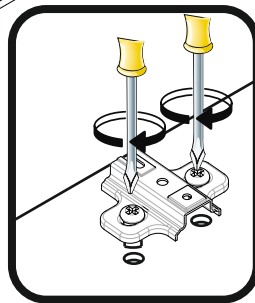
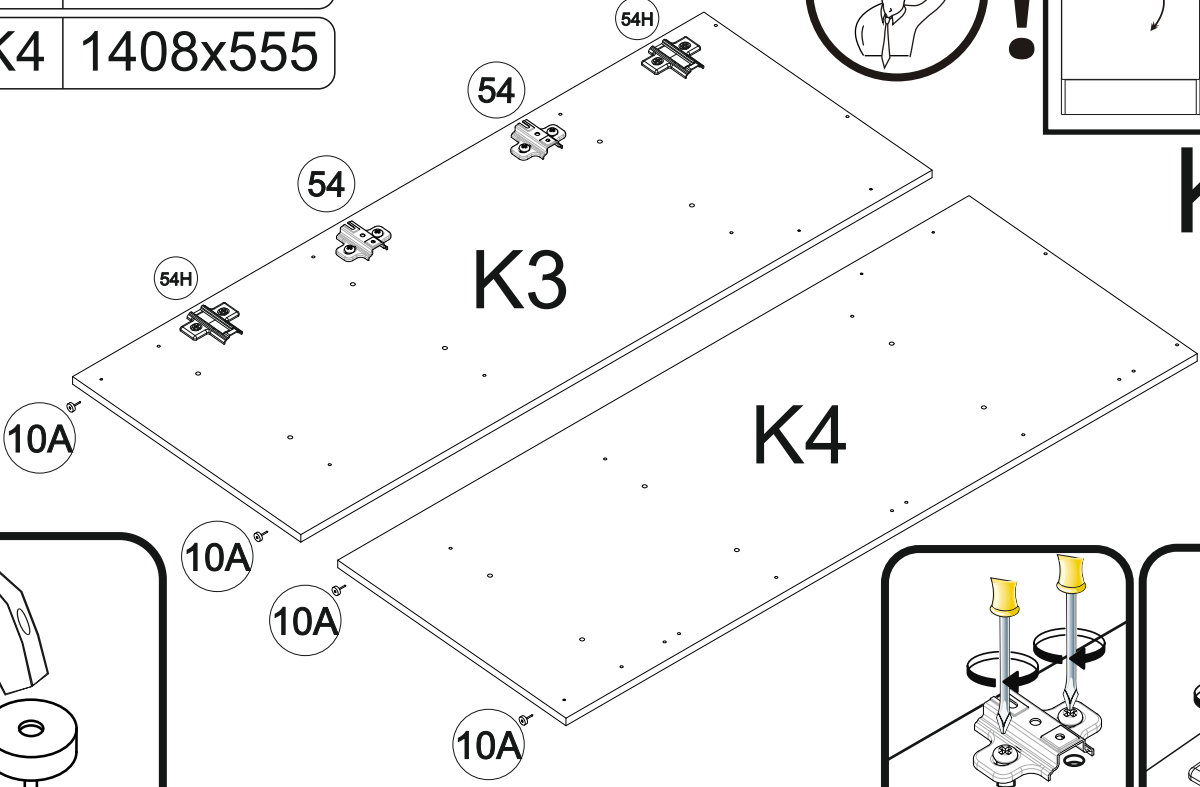
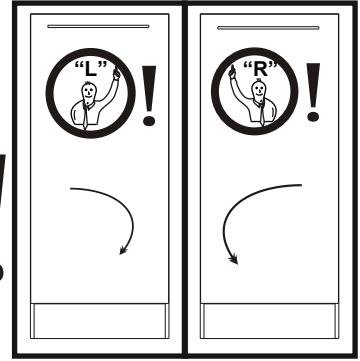
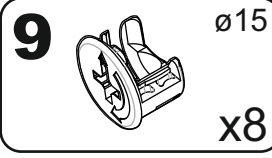
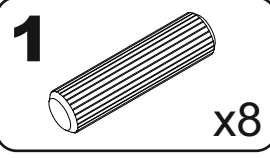
**2**

K1	567x510
----	---------

K5	567x74
----	--------

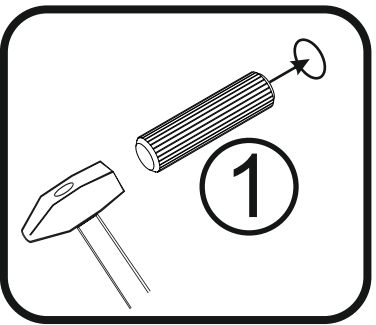
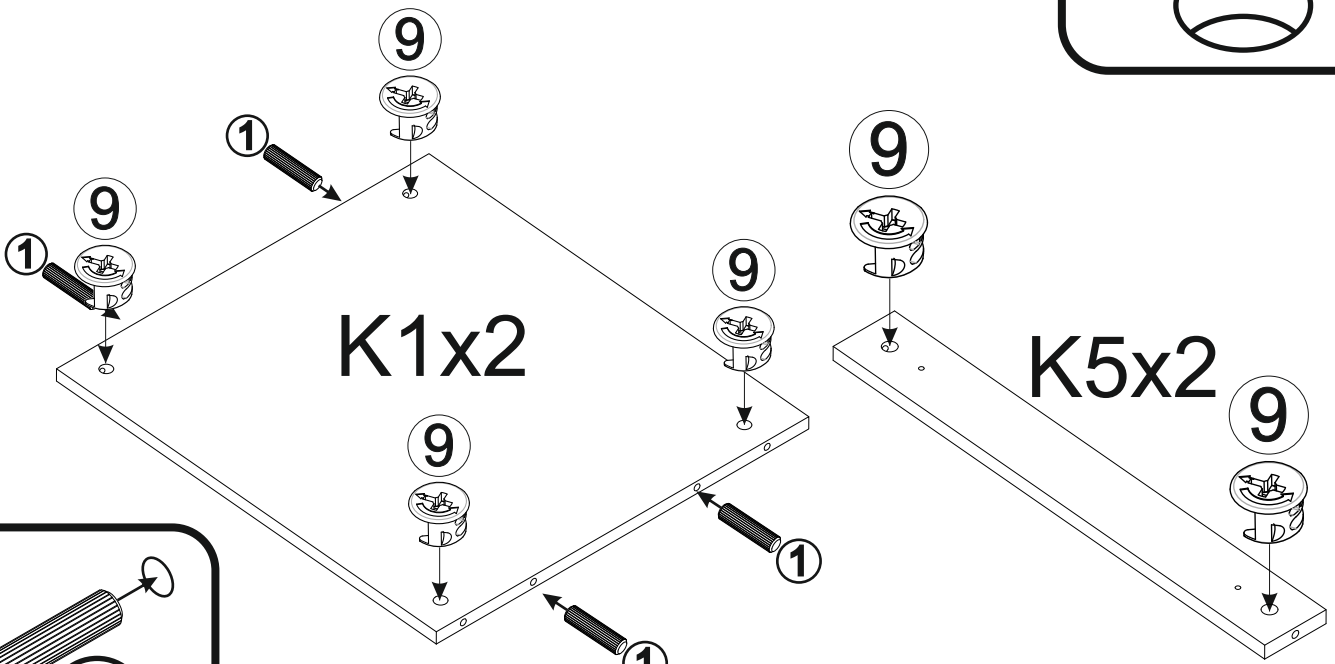
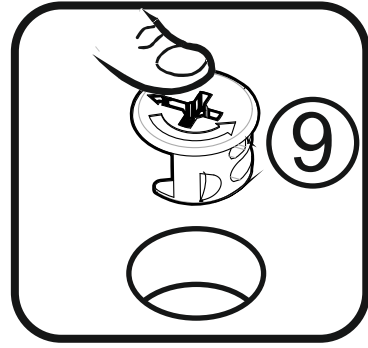

3

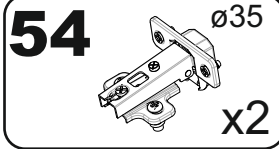
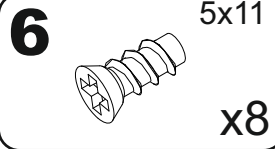
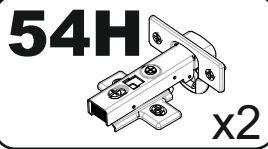

C61 1254x596

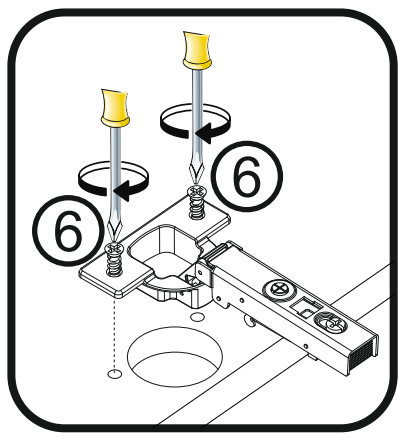
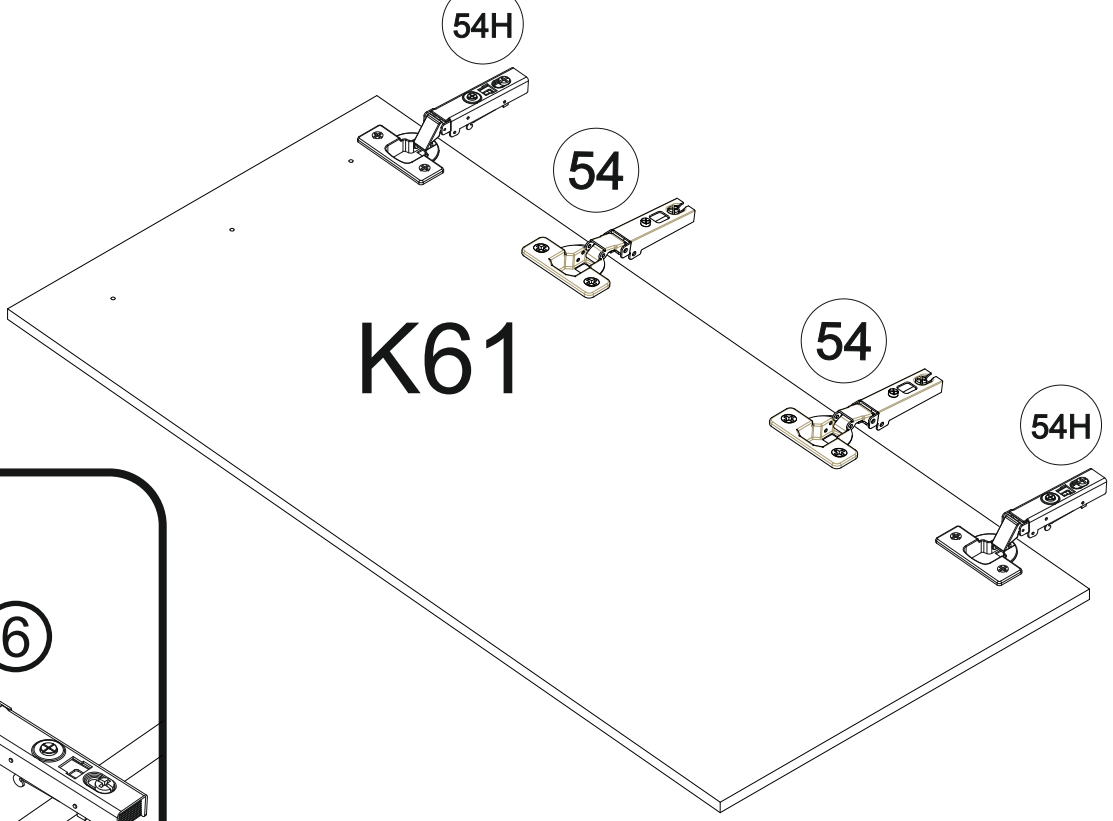

4

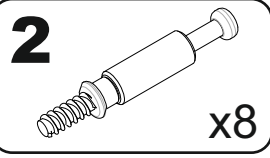

OPTION 1

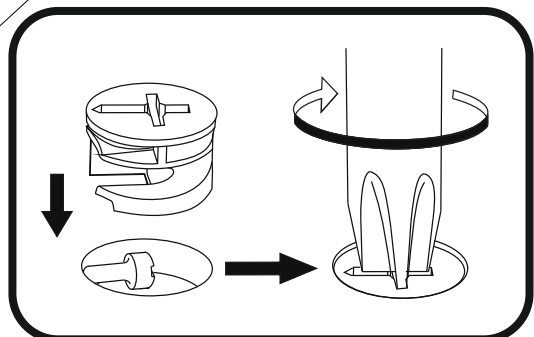
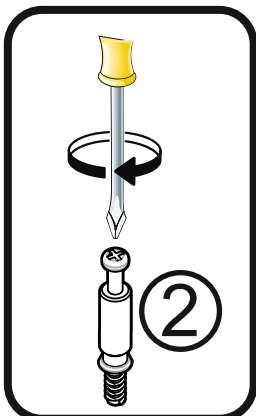
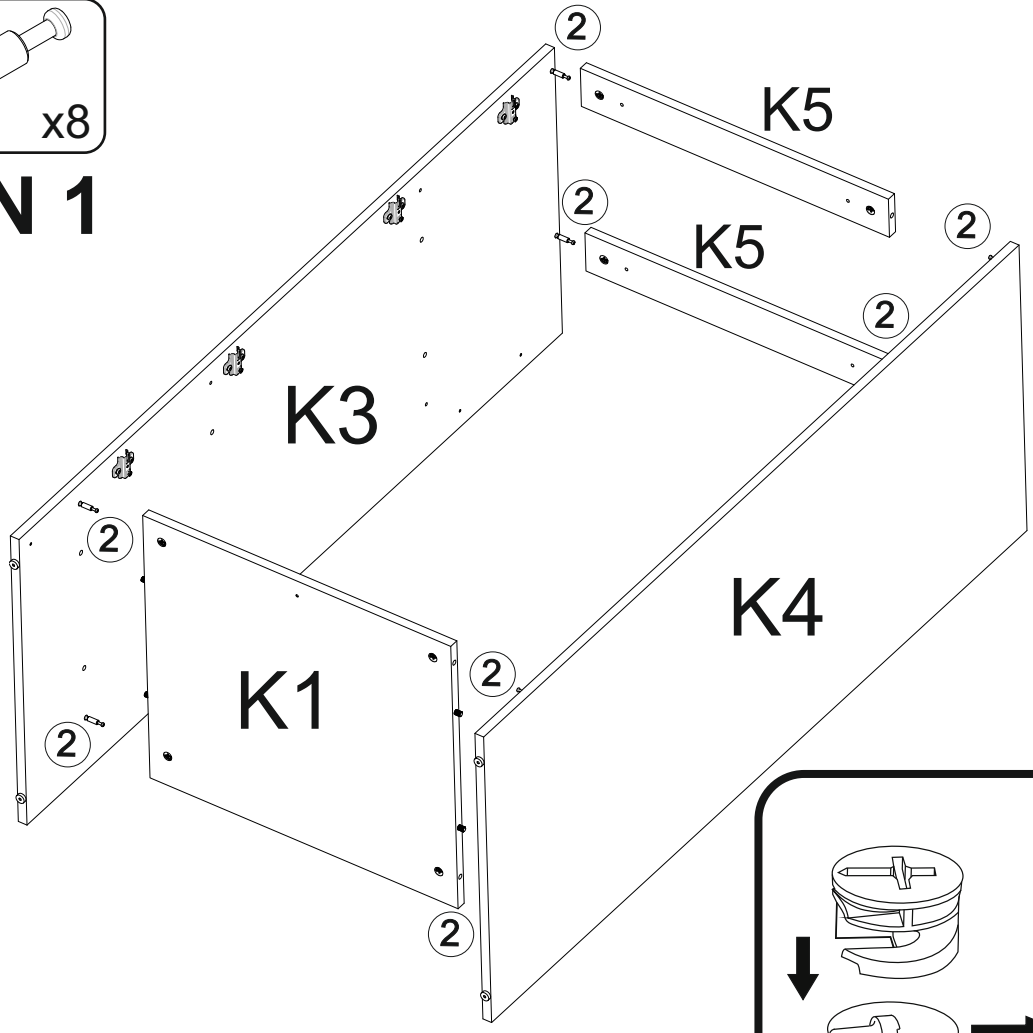
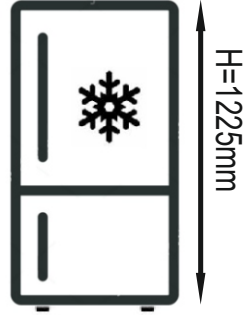

5

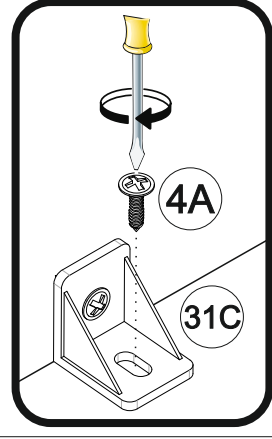
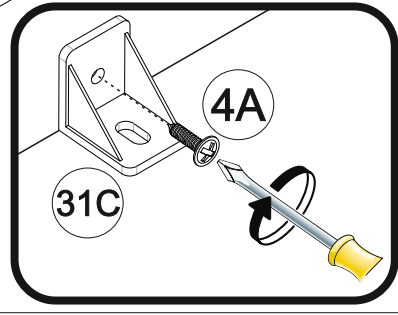
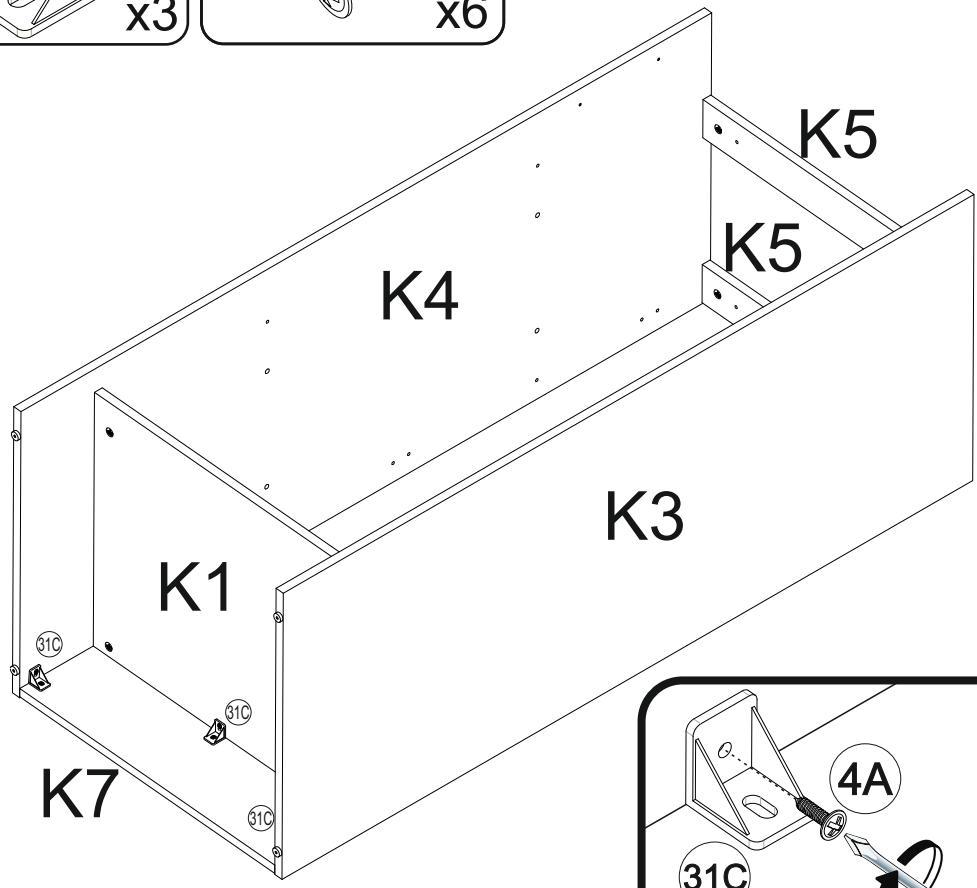
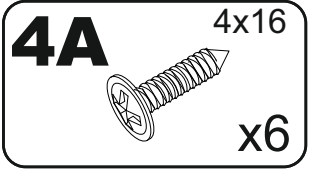
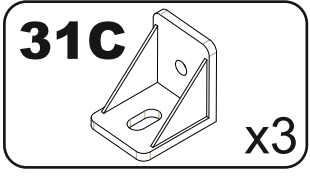

6

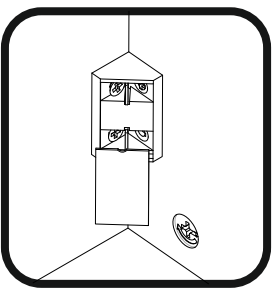
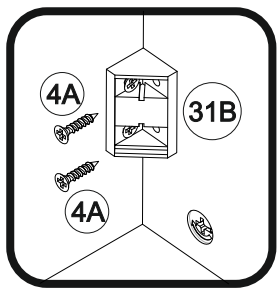
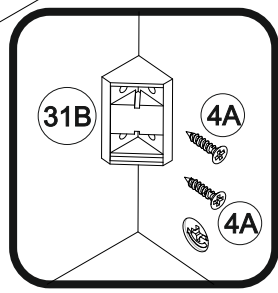
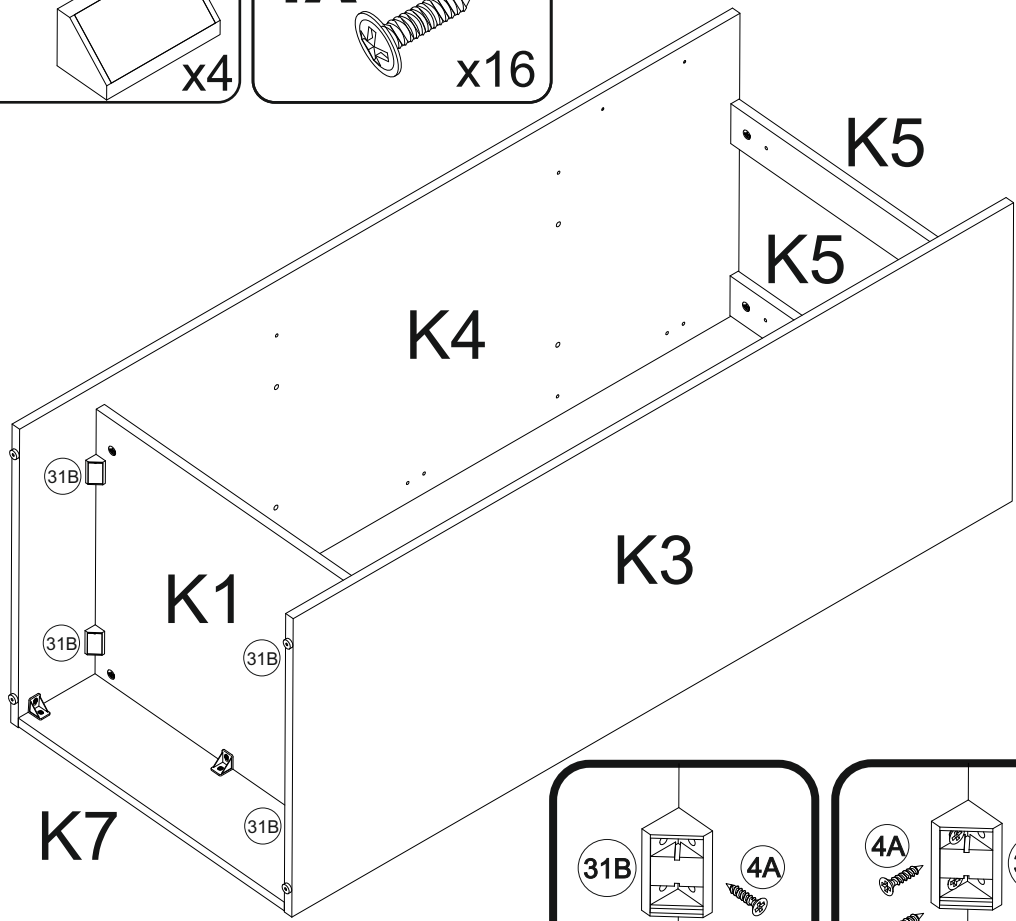
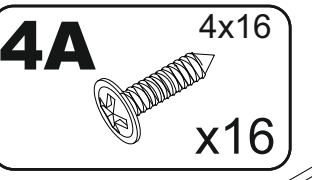
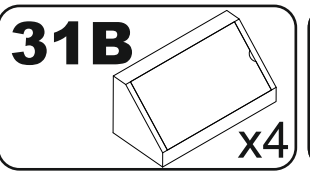

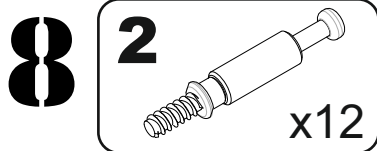
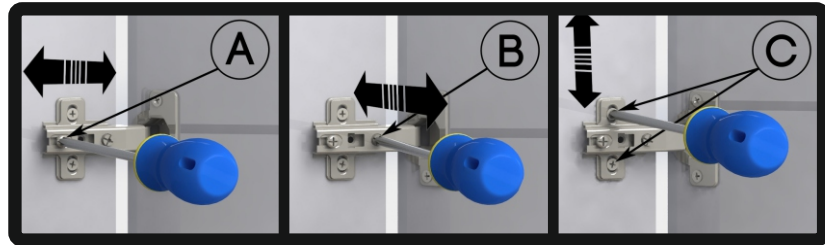
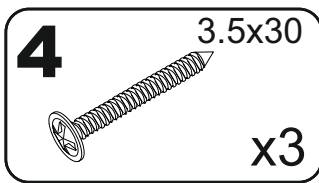
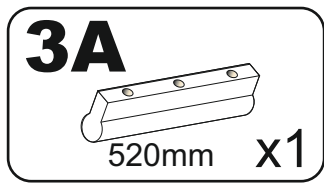
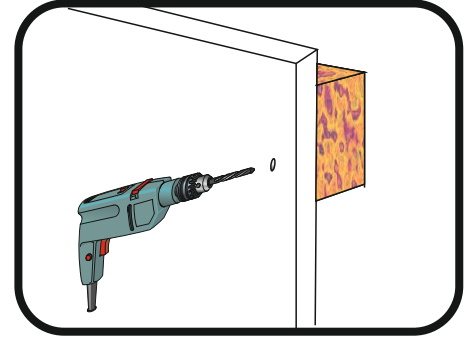
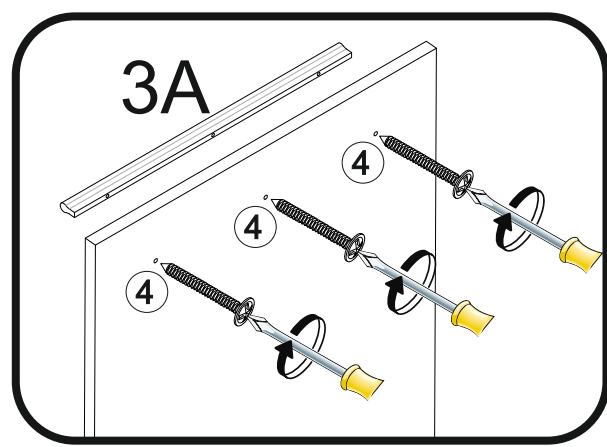
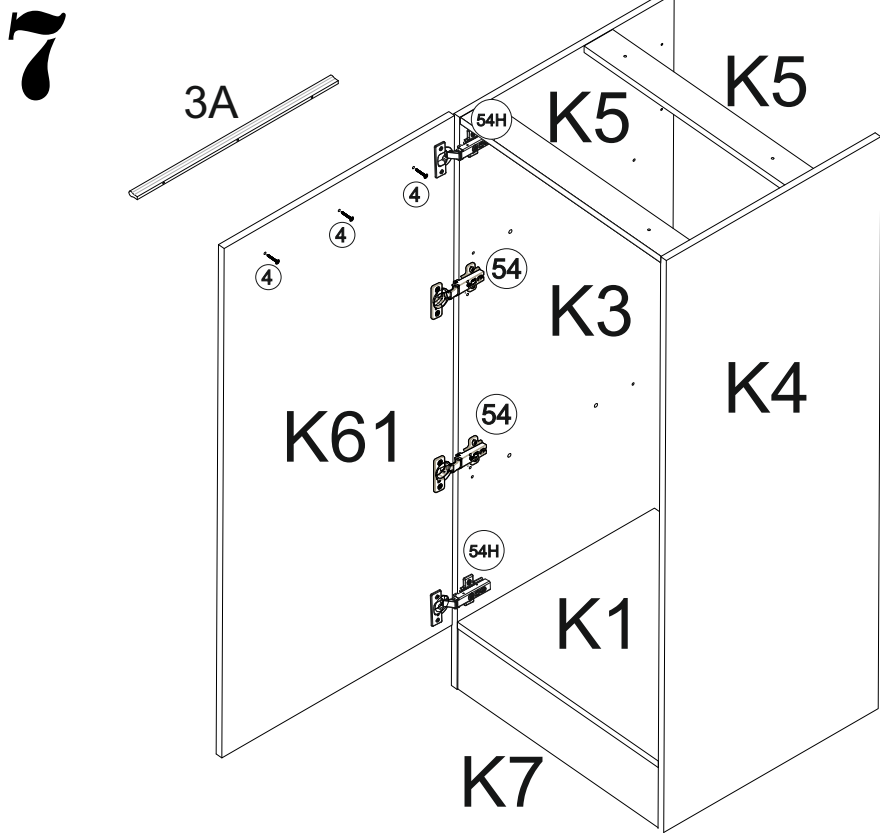

OPTION 2

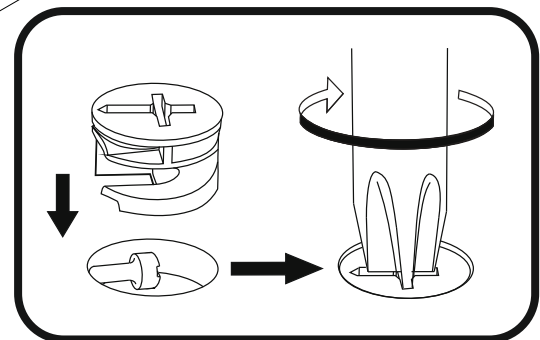
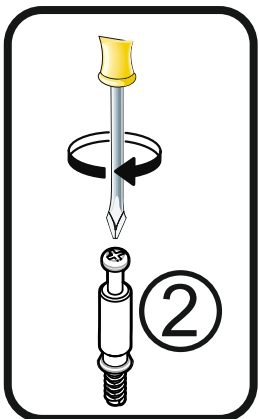
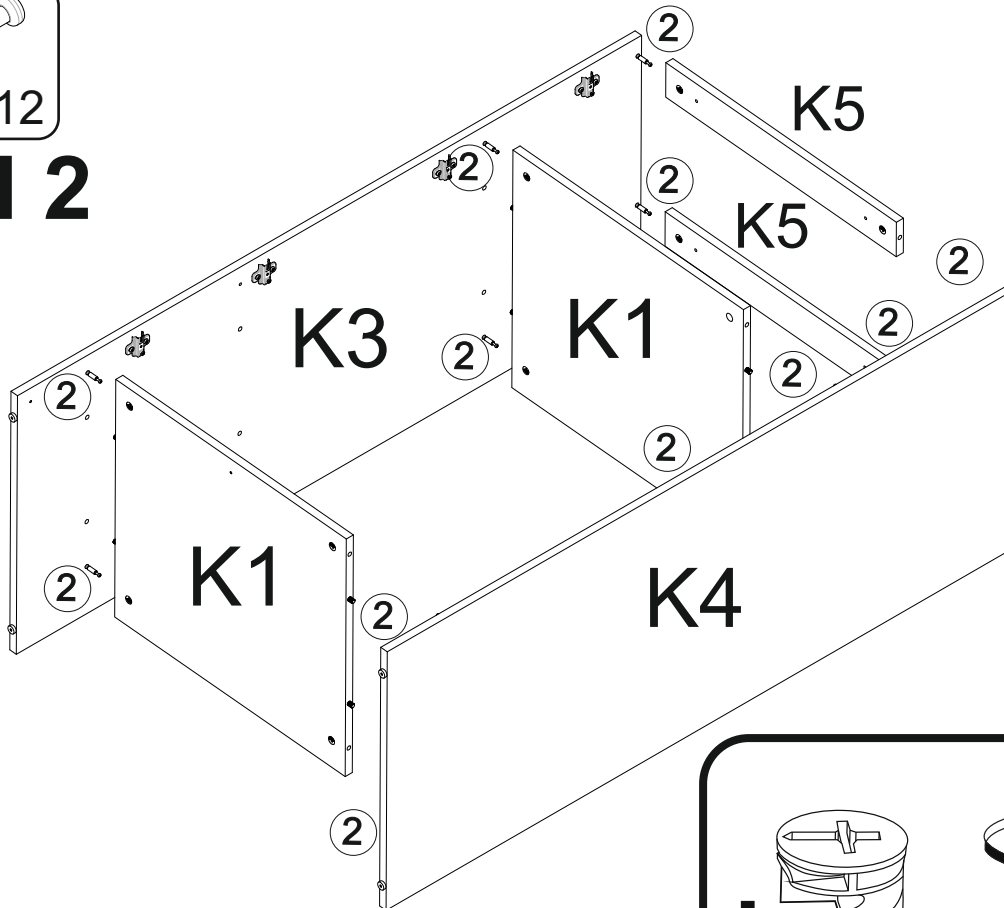
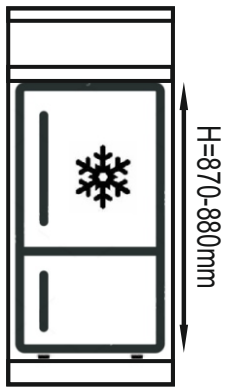

9

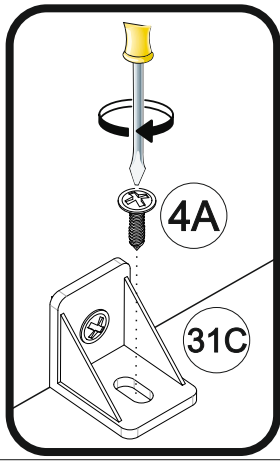
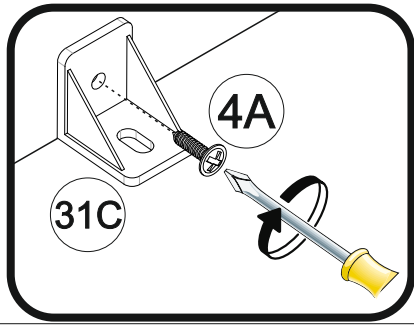
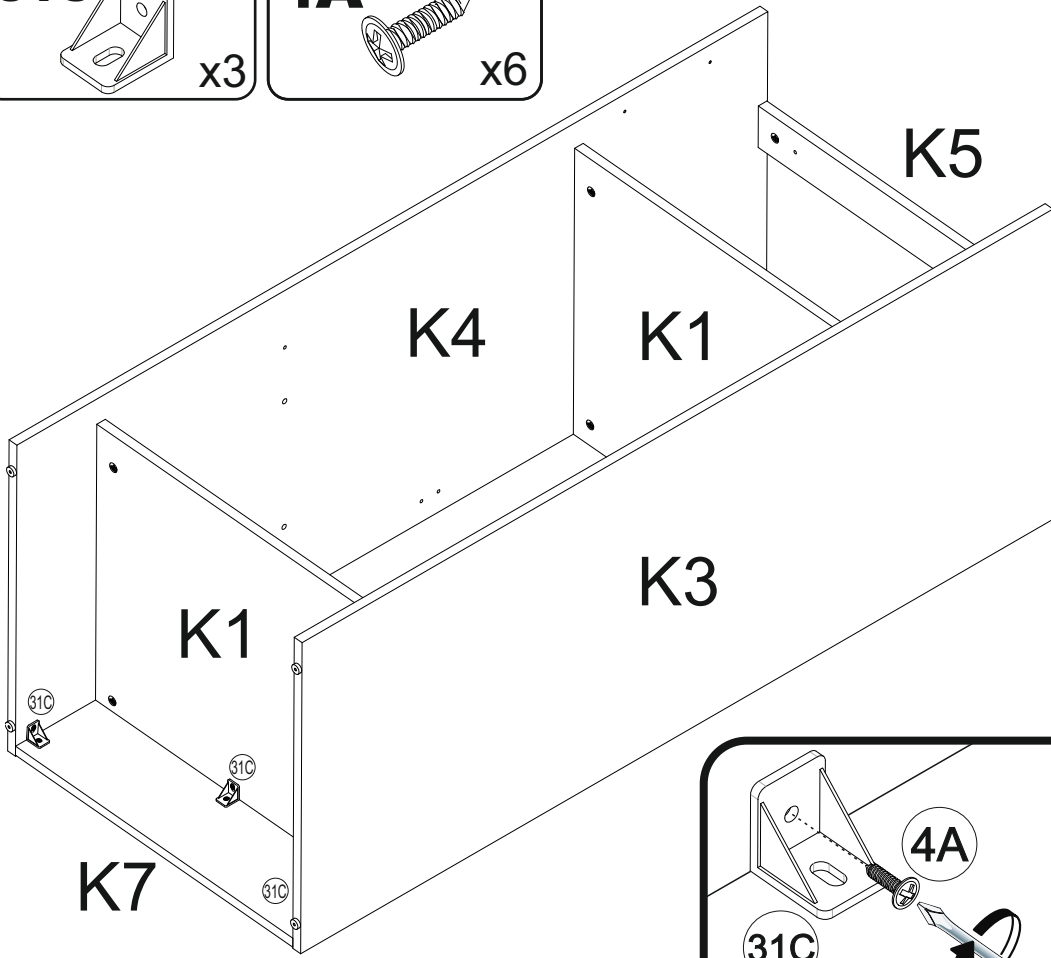
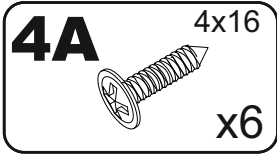
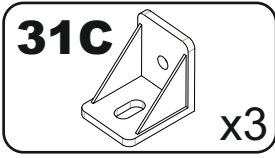

10

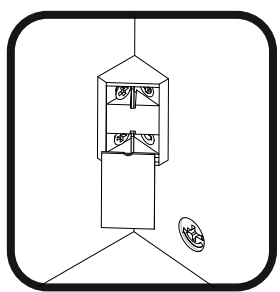
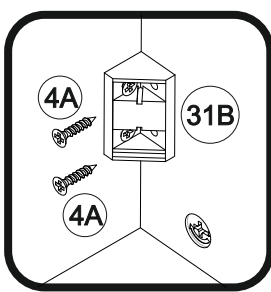
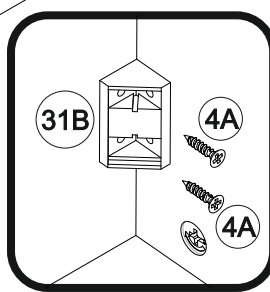
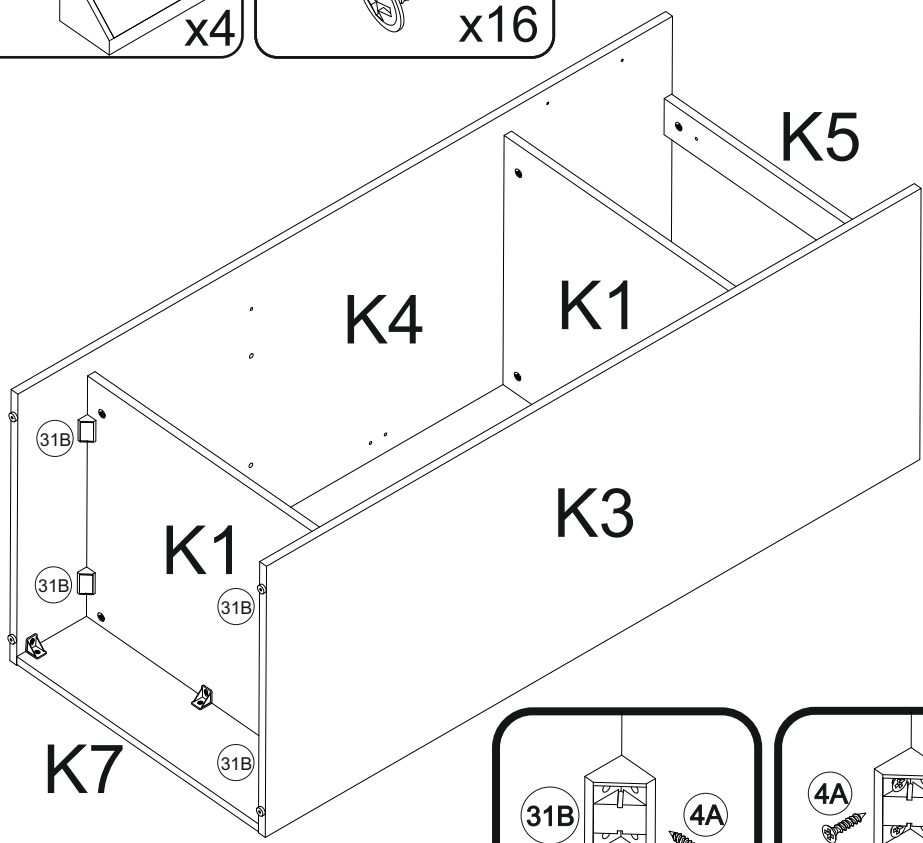
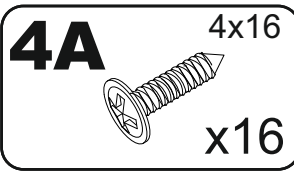
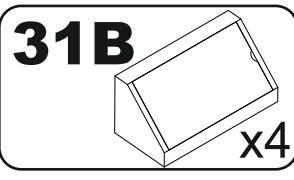

11

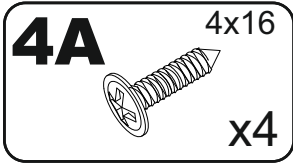
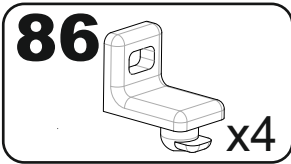

K8 357x566

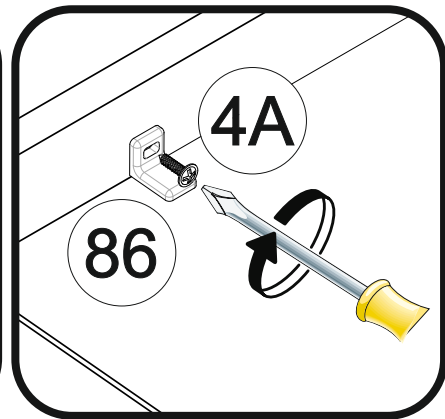
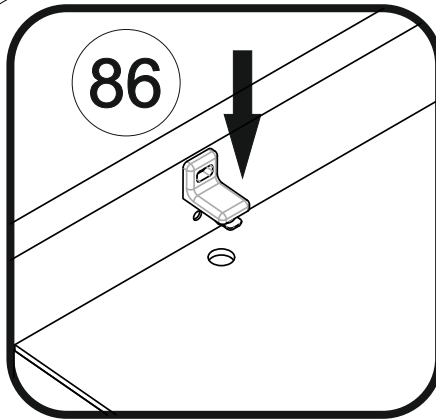
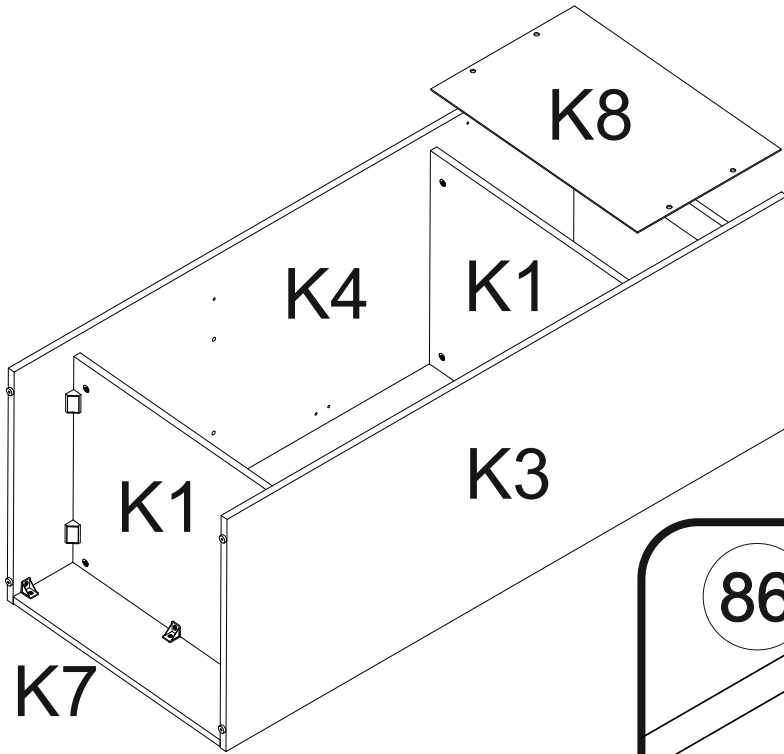

12

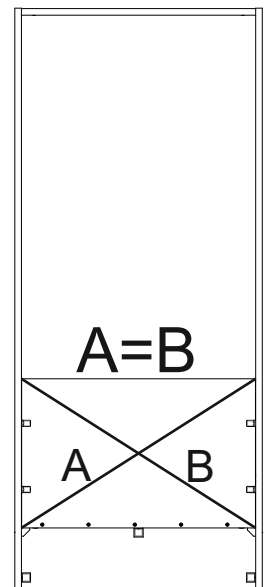
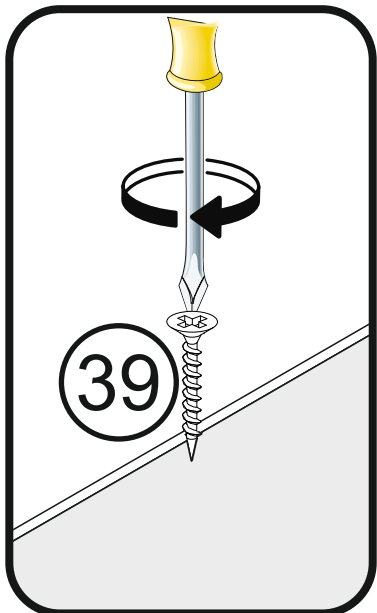
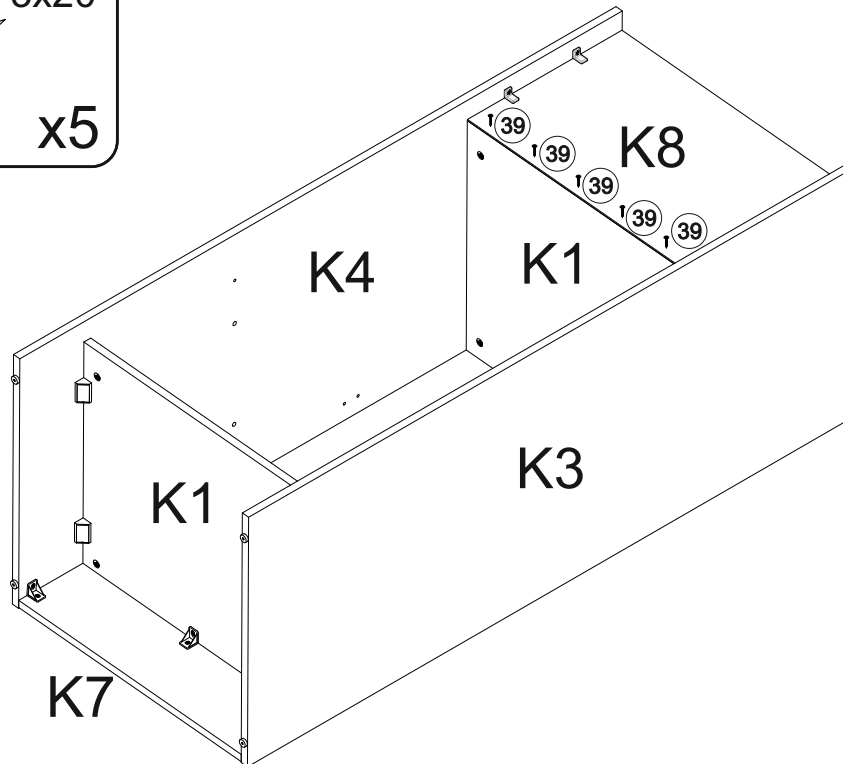
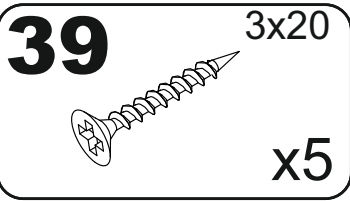

13

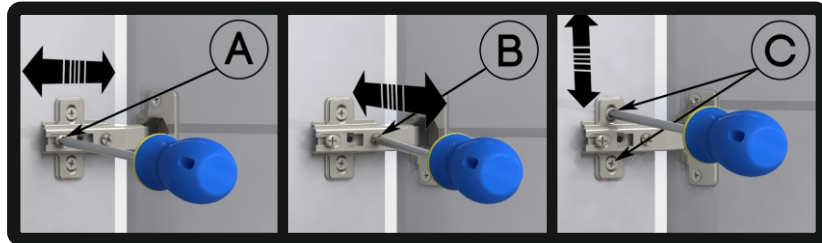
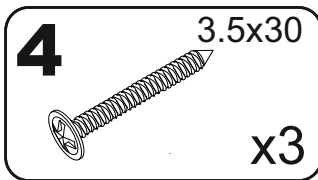
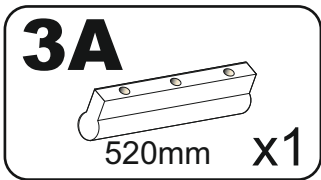
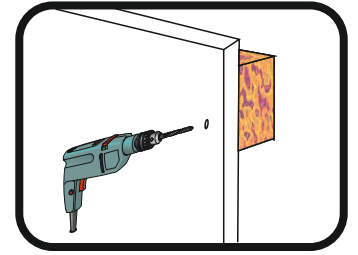
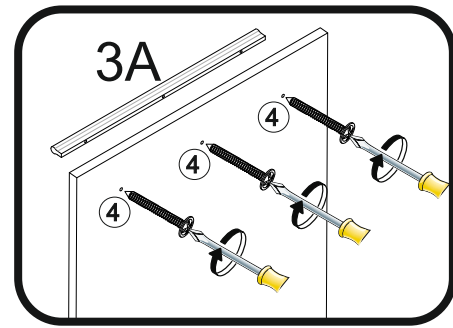
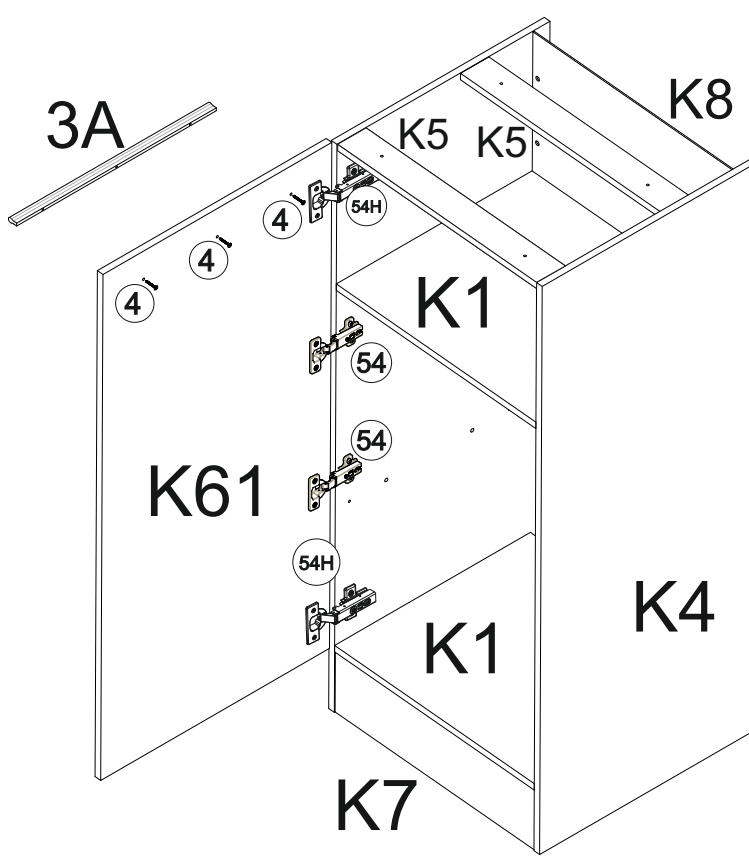

14

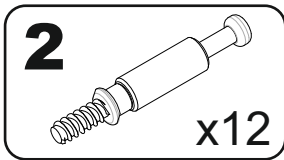

OPTION 3

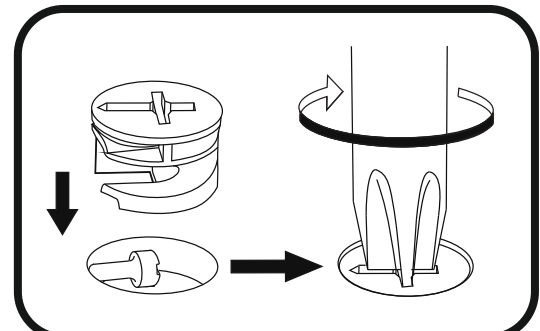
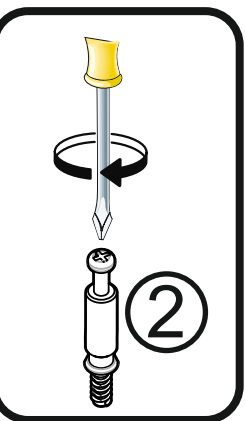
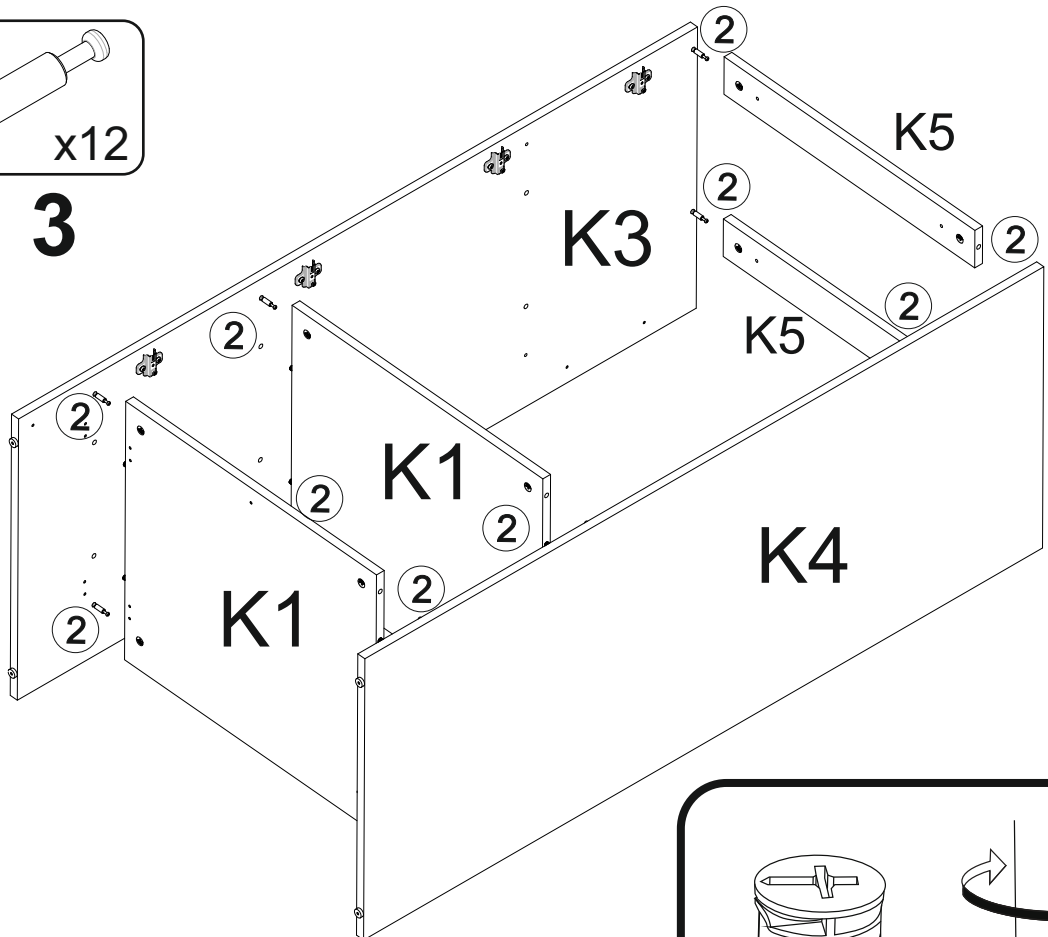
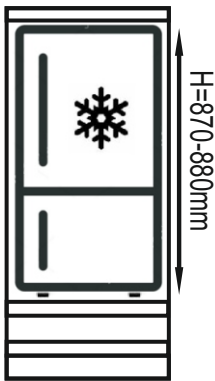

15

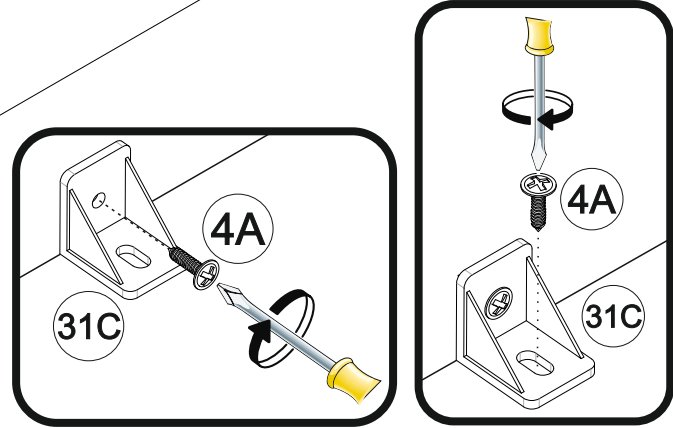
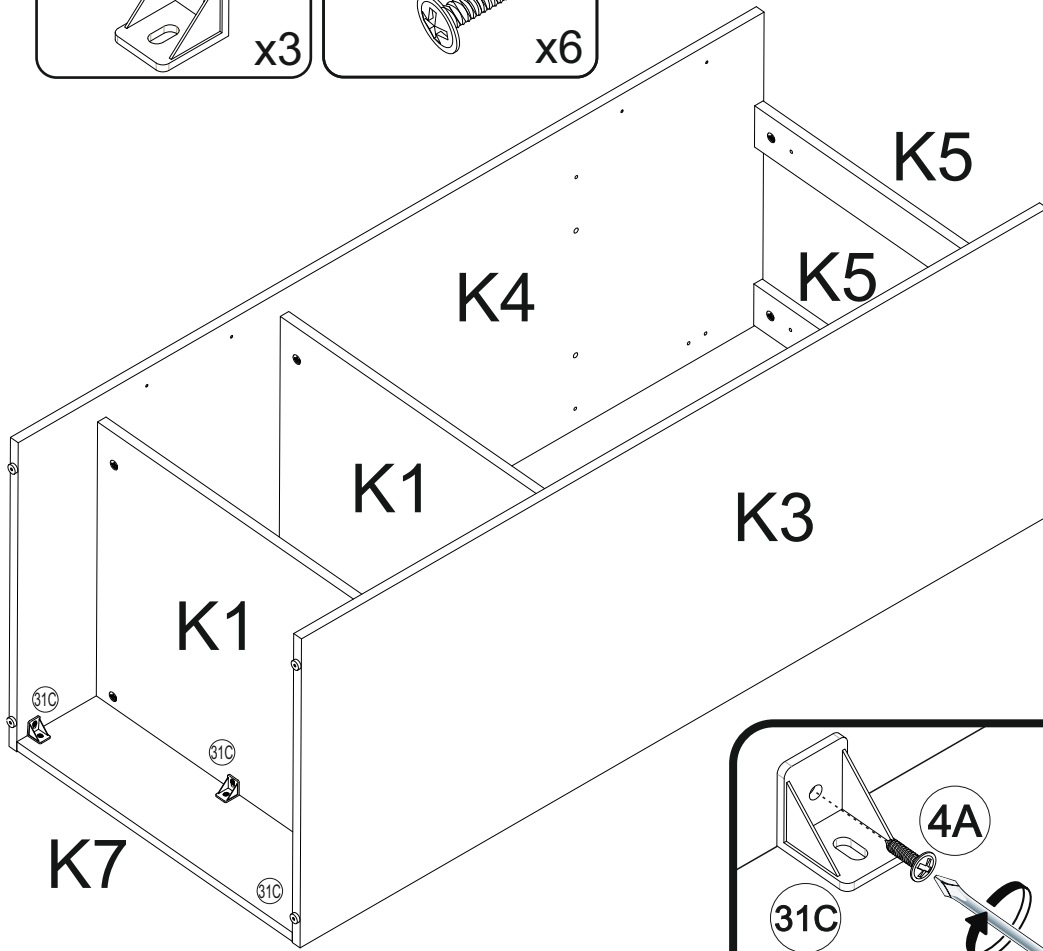
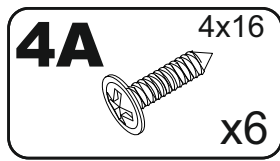
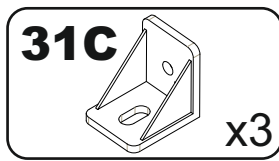

16

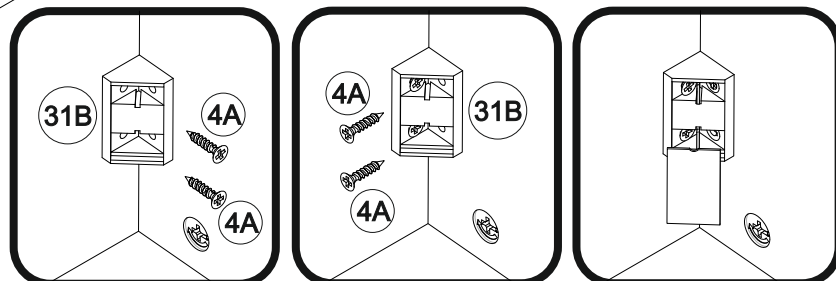
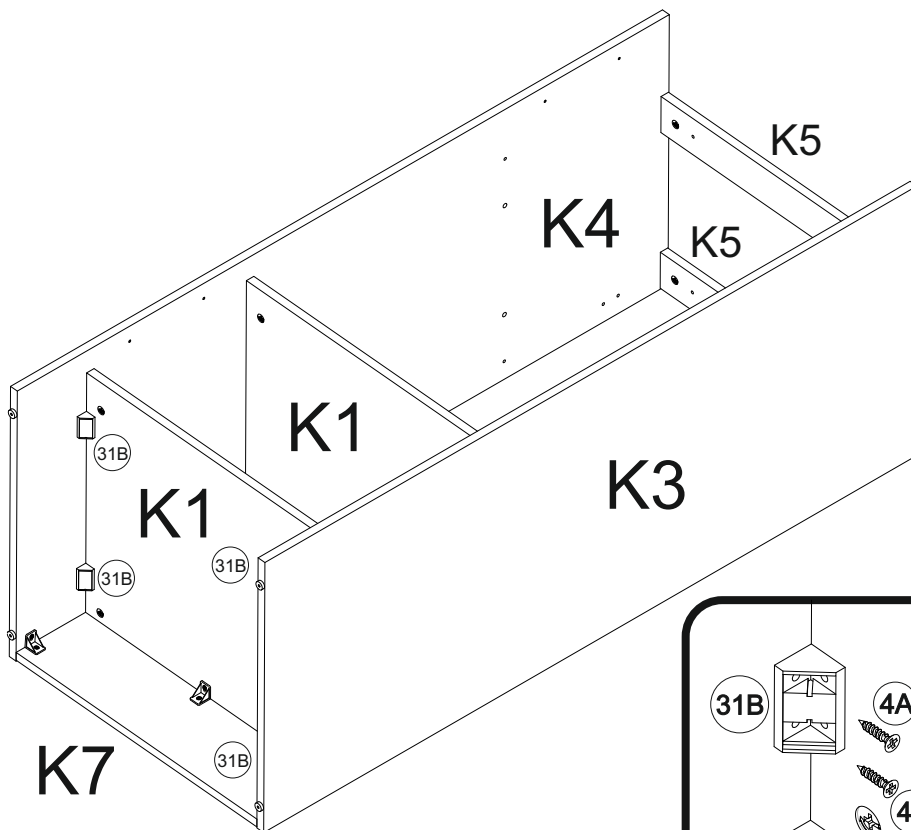
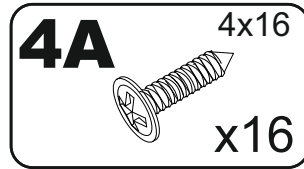
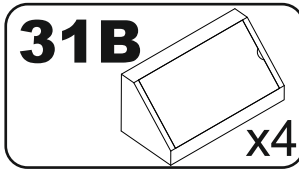

17

86

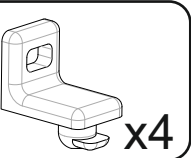

4A

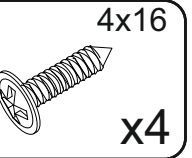

K8

357x566

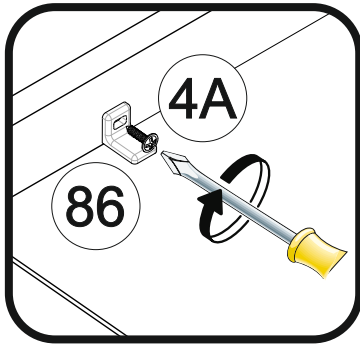
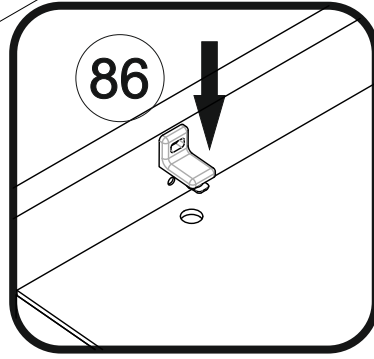
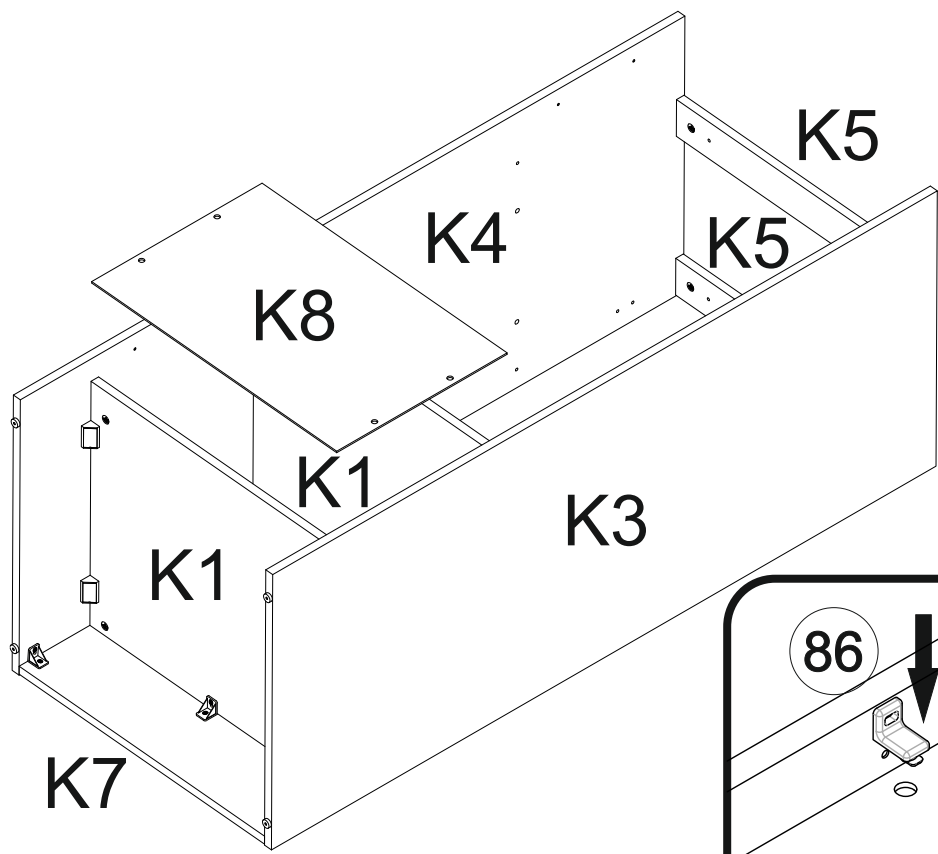

18

39

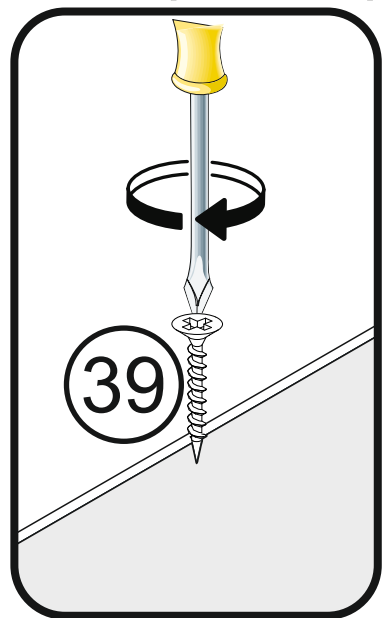
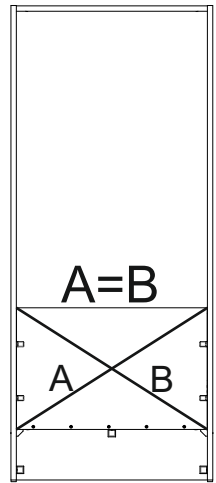
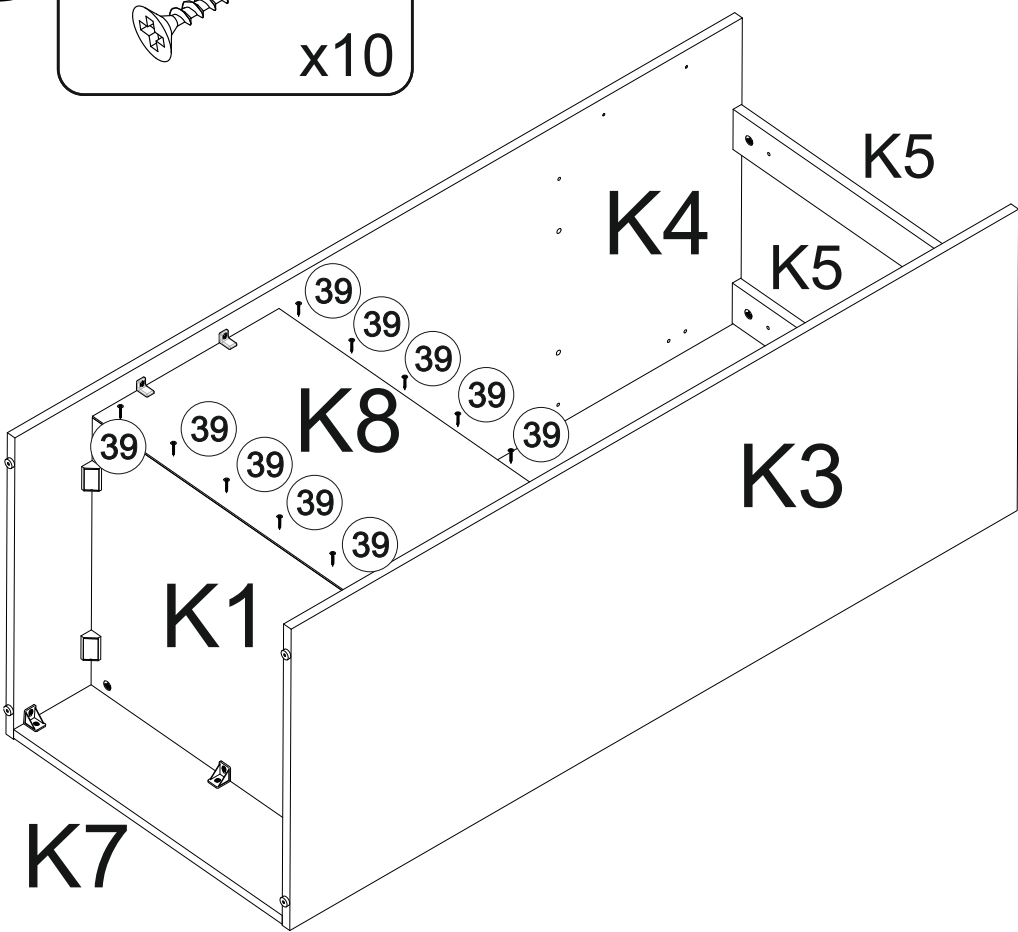
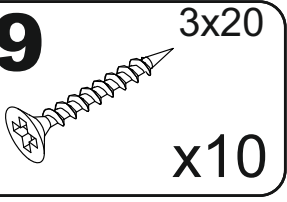

19

3A

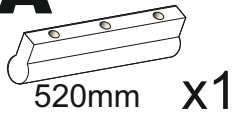

520mm x1

4

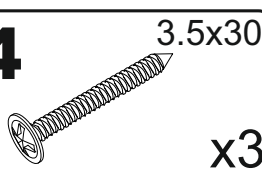

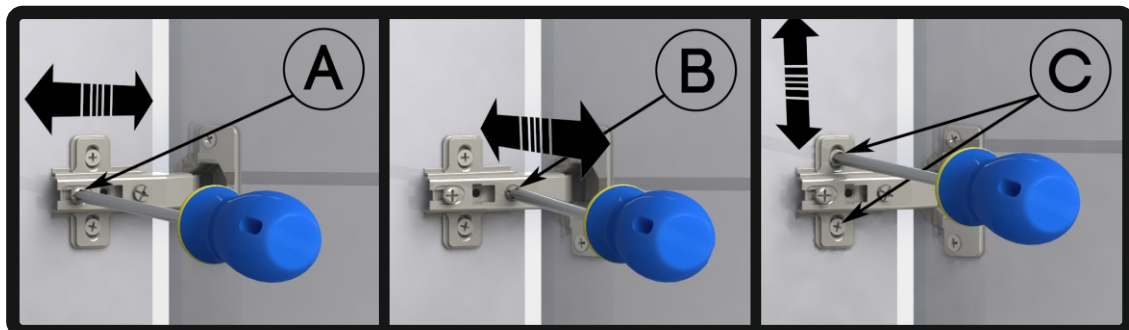
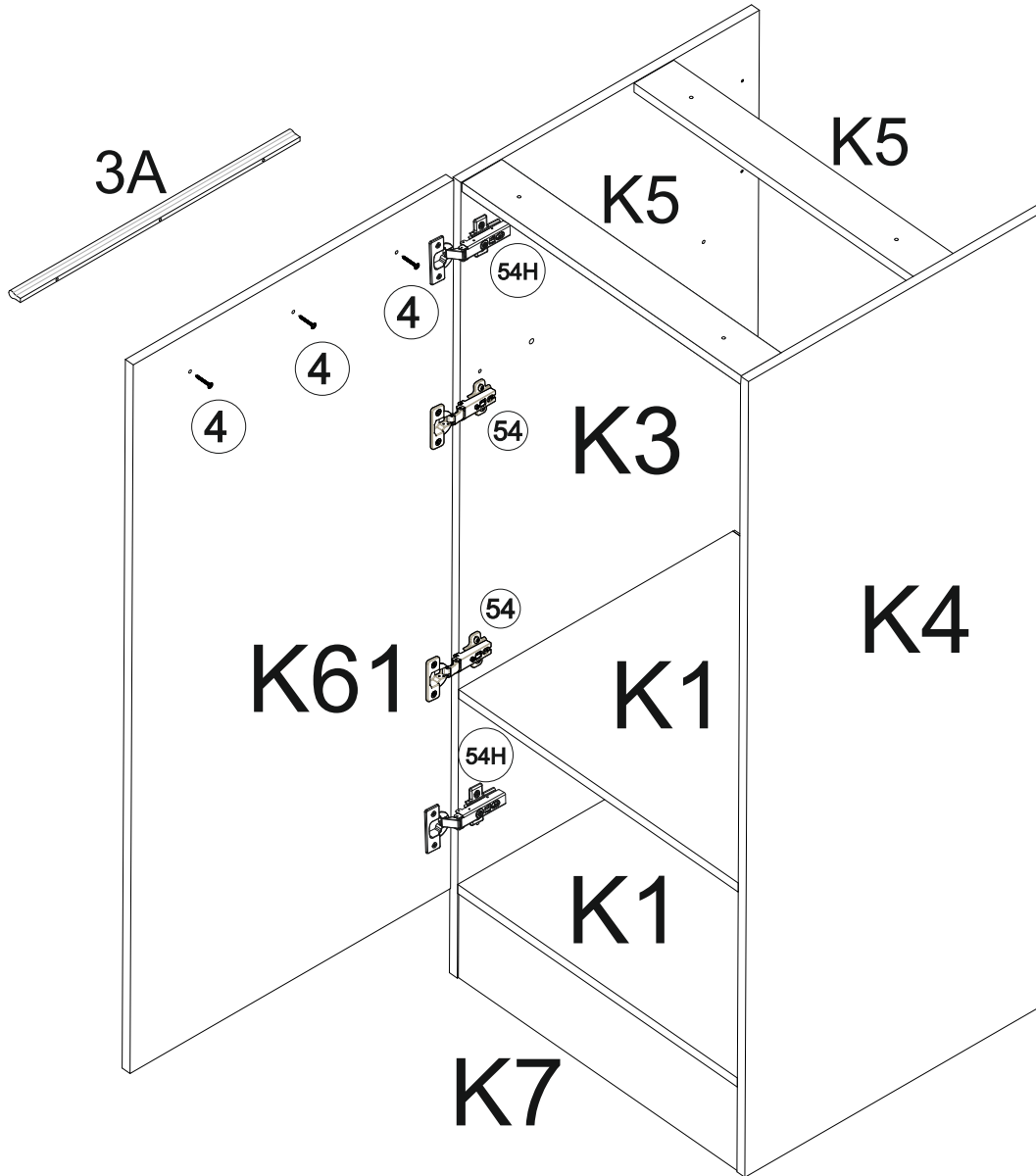
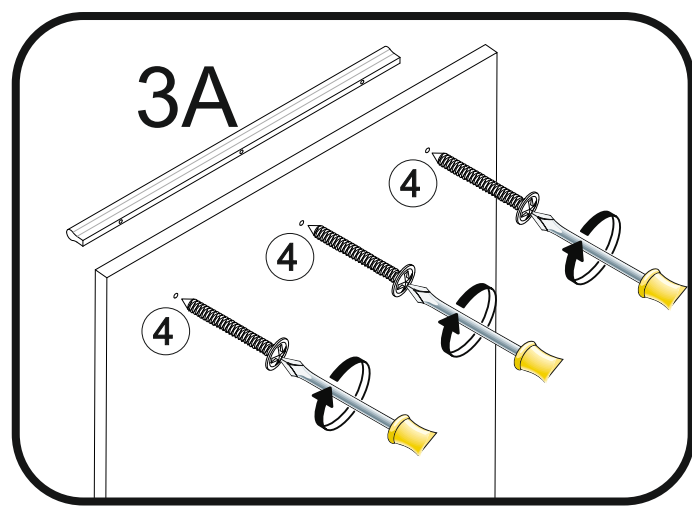
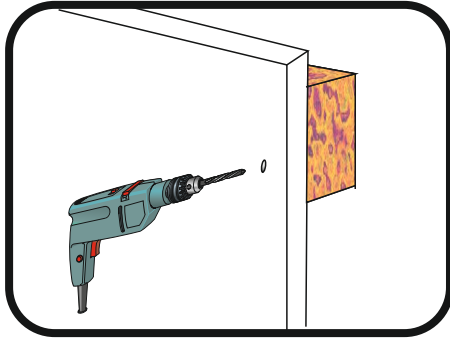

3.5x30 x3

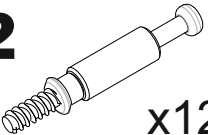
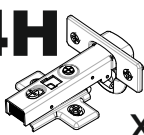
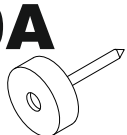

- 1**  x12
- 2**  x2
- 10A**  x4

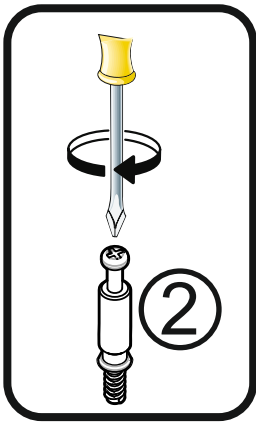
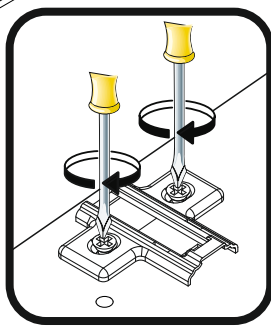
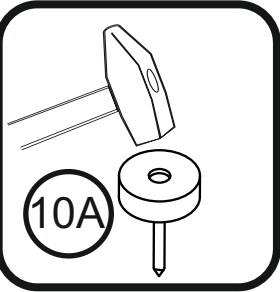
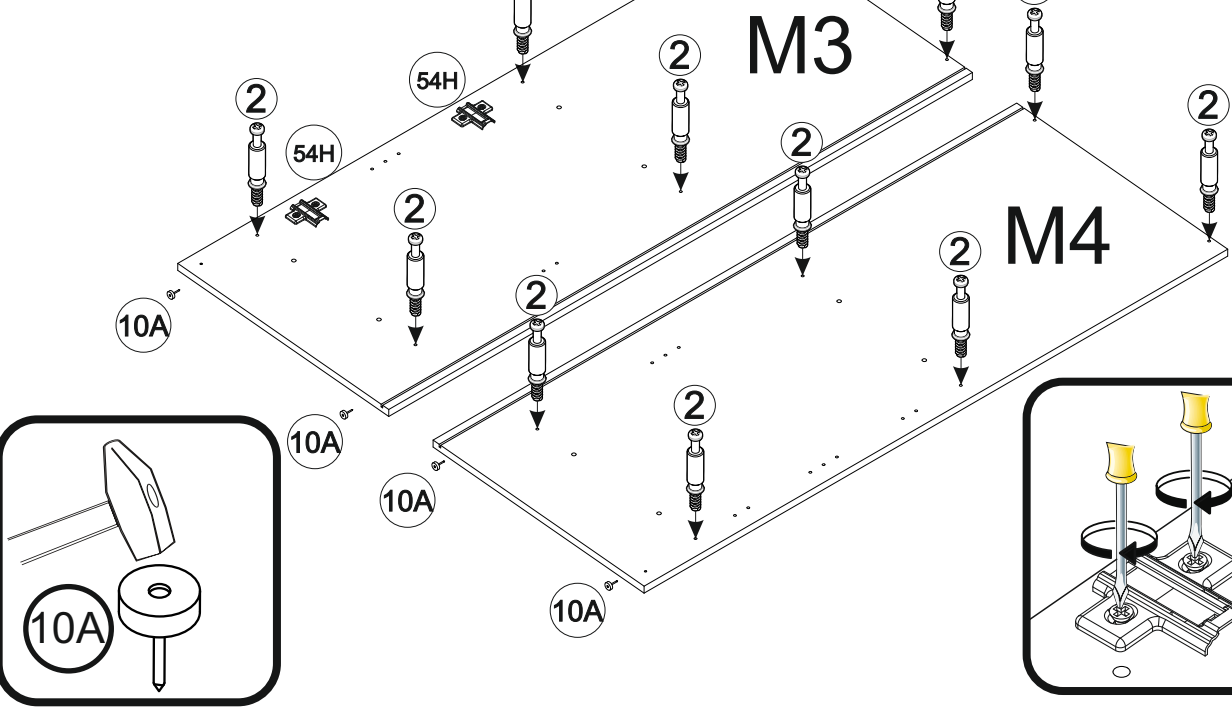
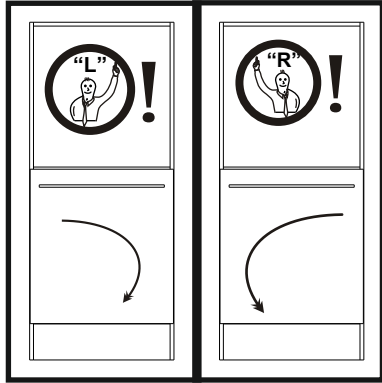
- M3 1408x555
- M4 1408x555

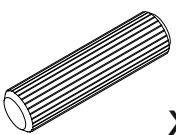

- 2** **1**  x8
- 9**  $\varnothing 15$ x12
- M1 567x535
- M5 567x74

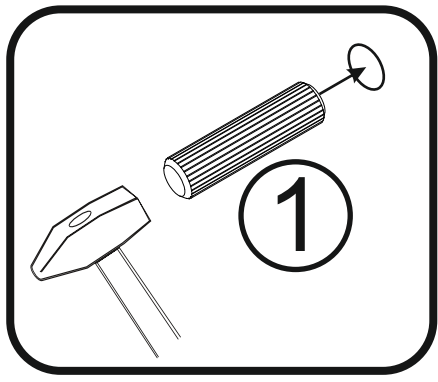
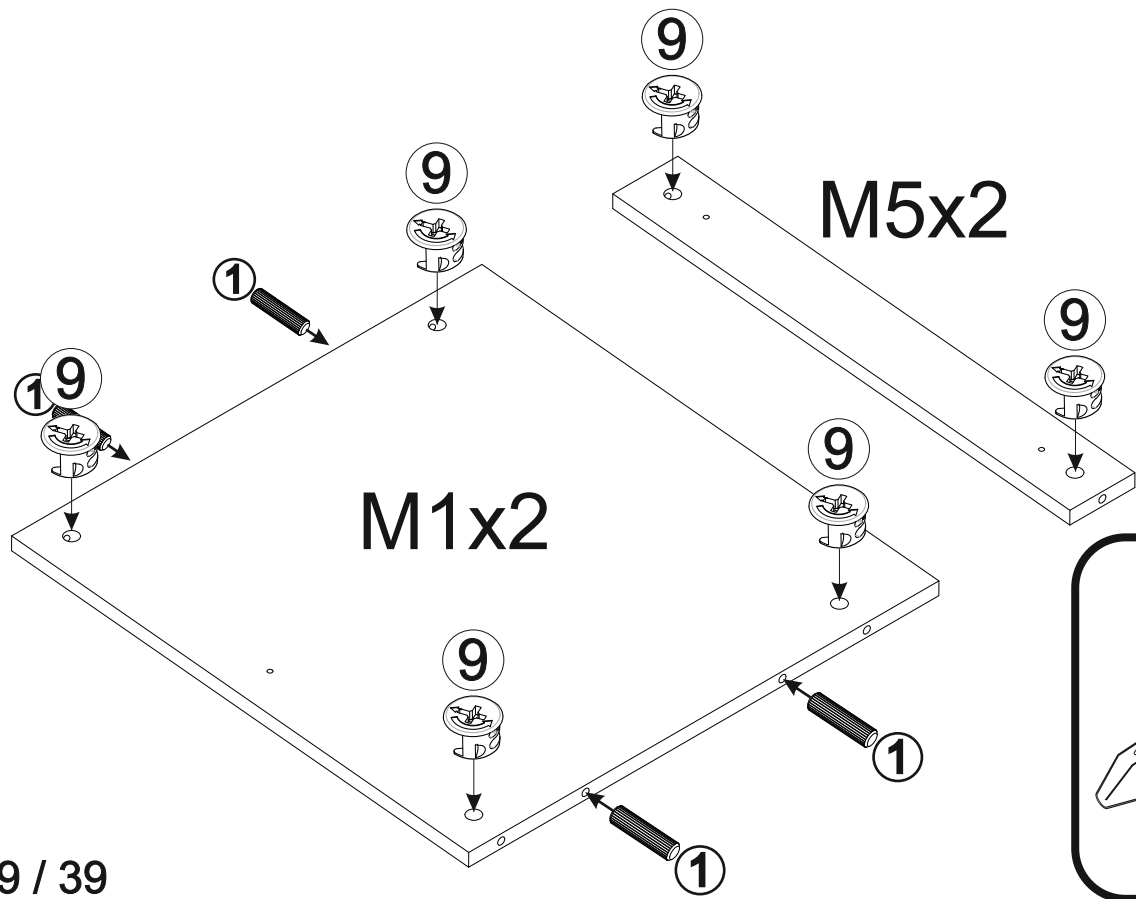
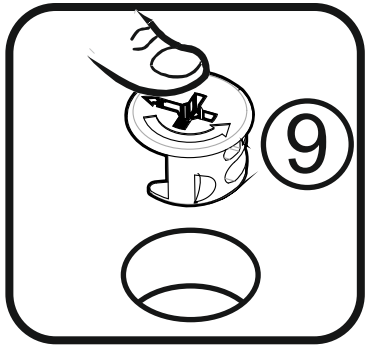

3

54H

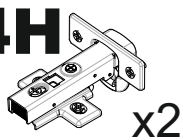

x2

6

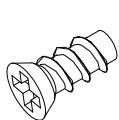

5x11

x4

M61

646x596

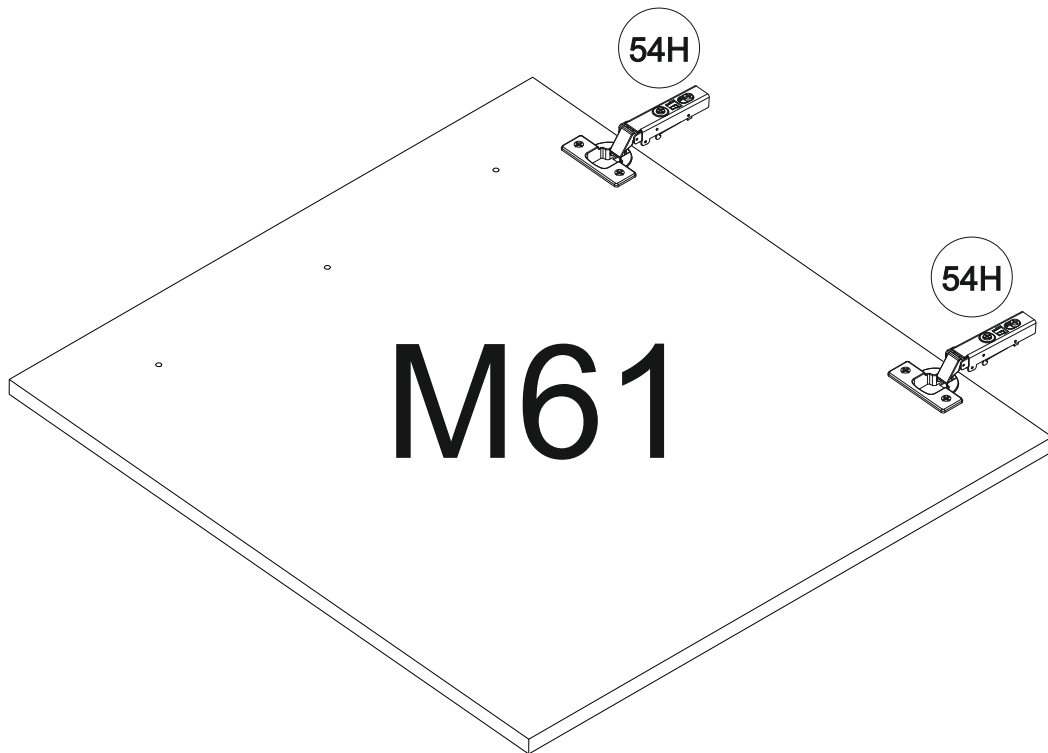
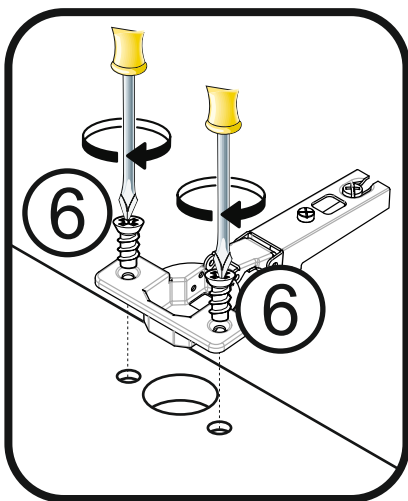

4

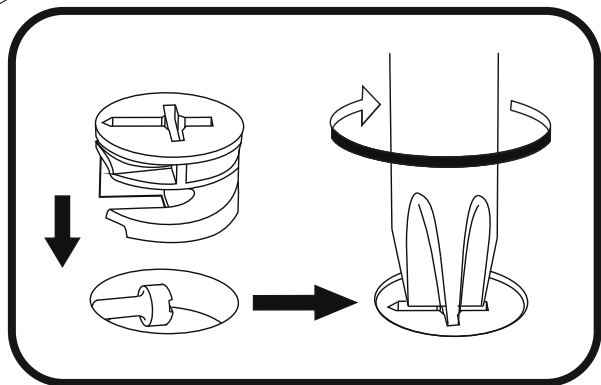
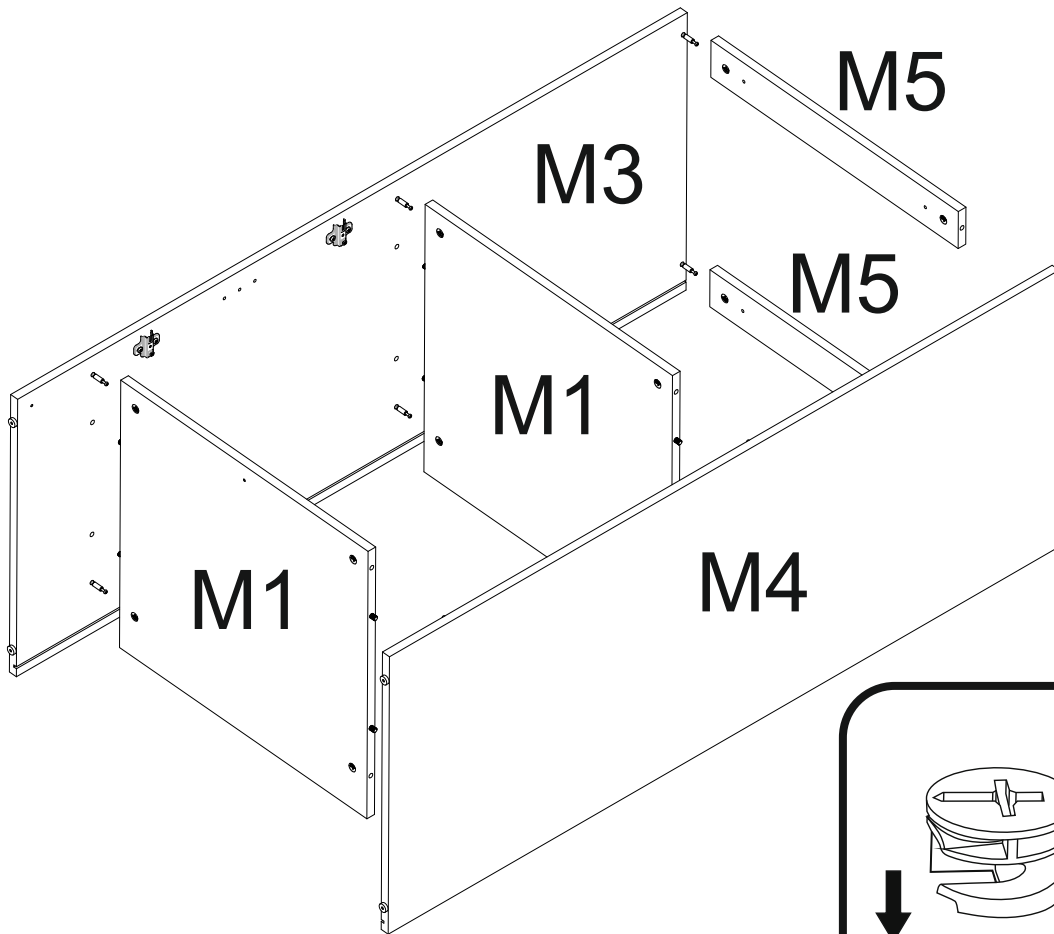

5

31C

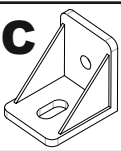

x3

4A

4x16

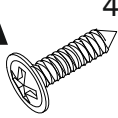

x6

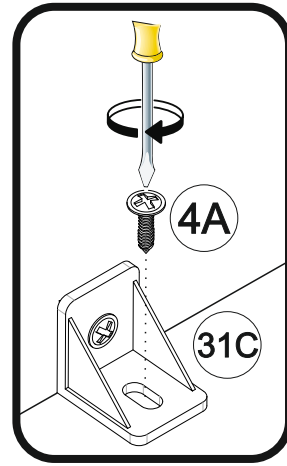
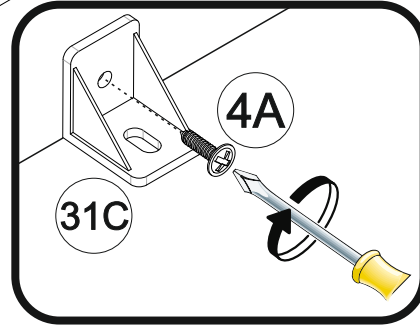
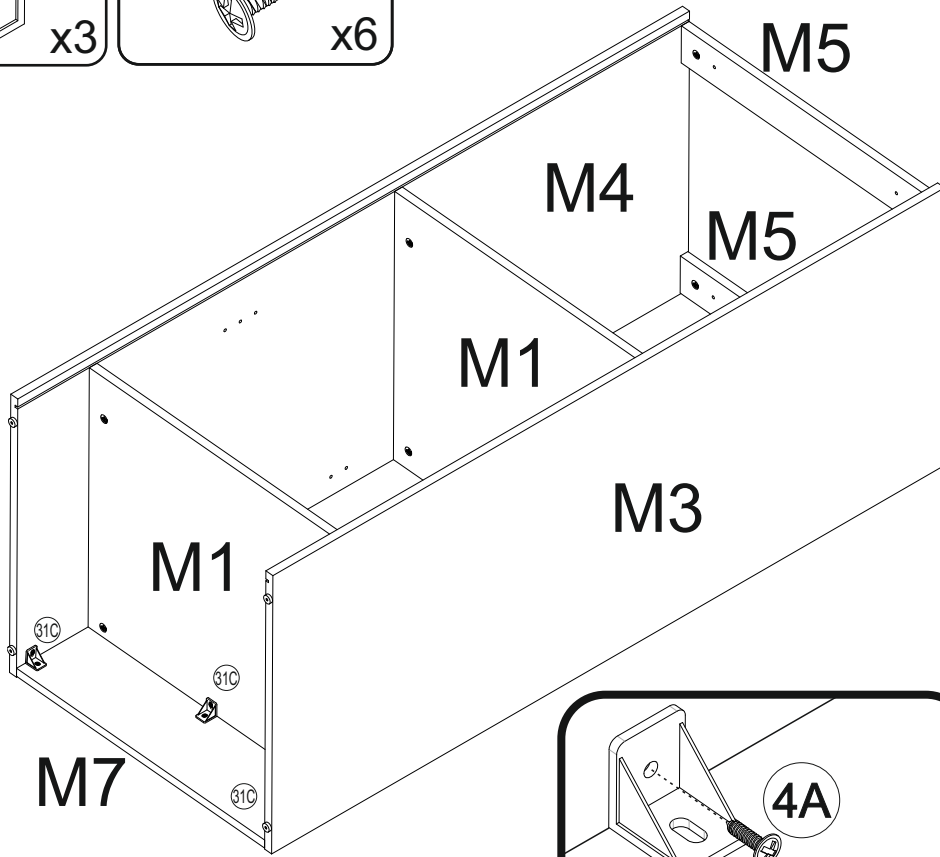

6

M8

645x577

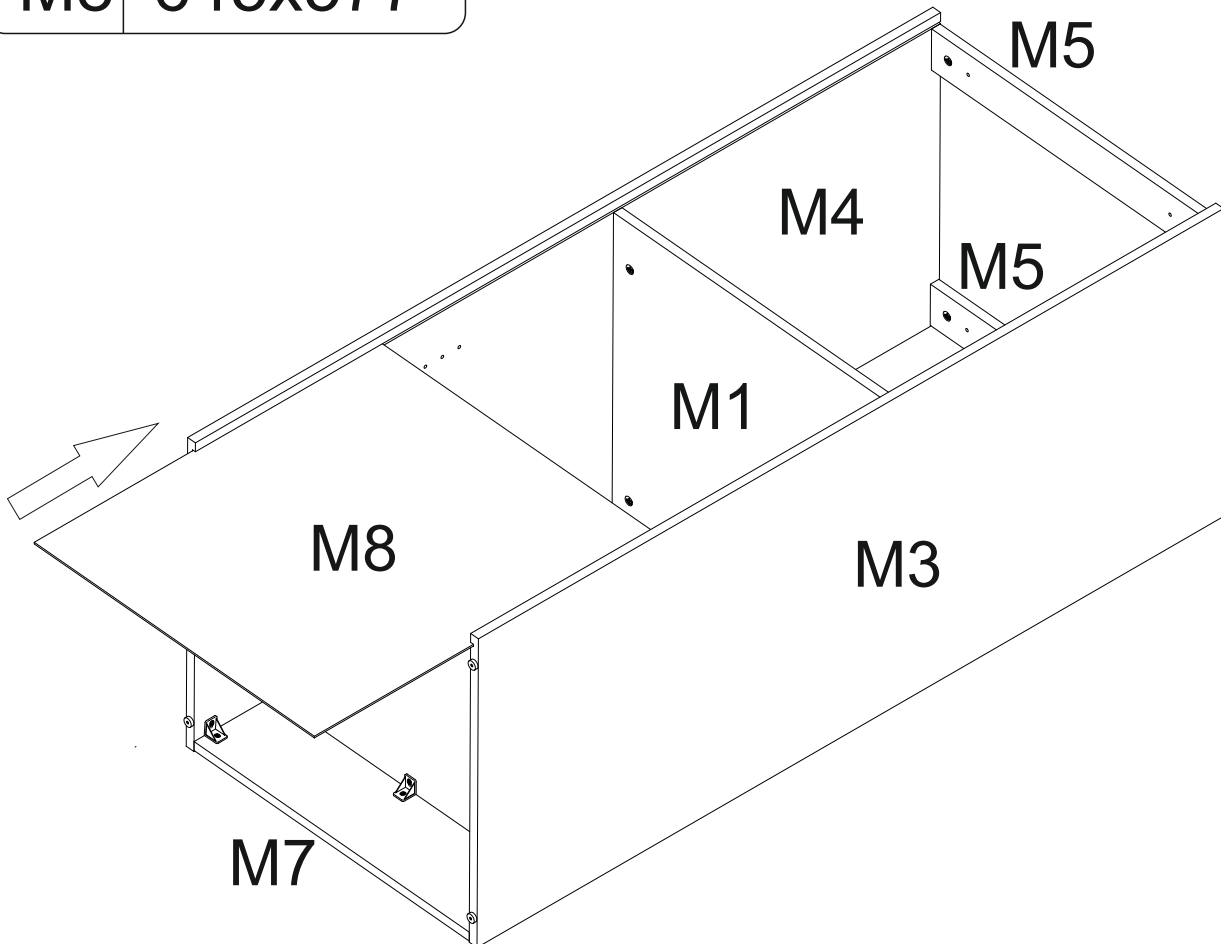

7

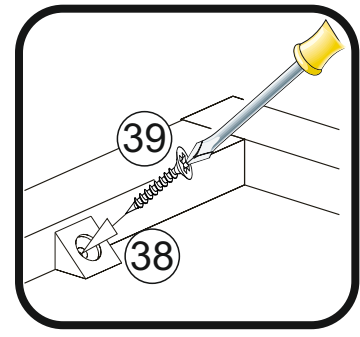
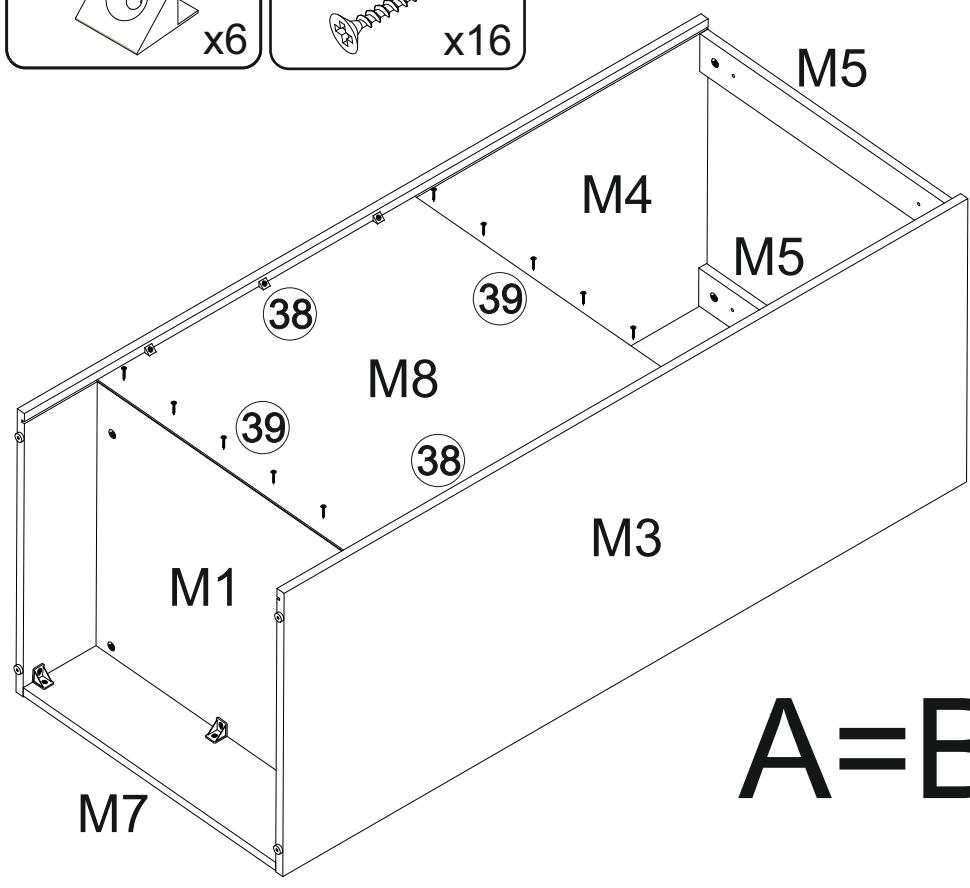
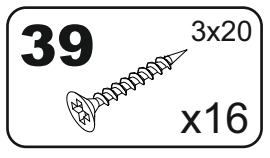
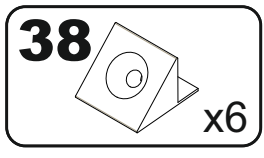

A=B

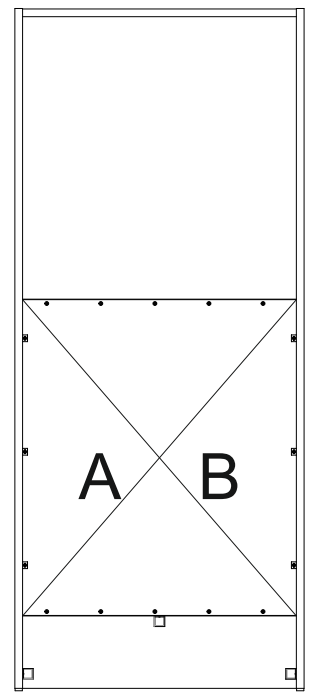

8

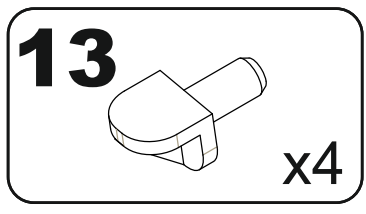

M2 | 567x510

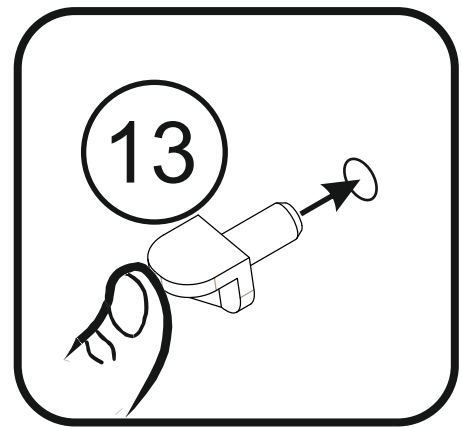
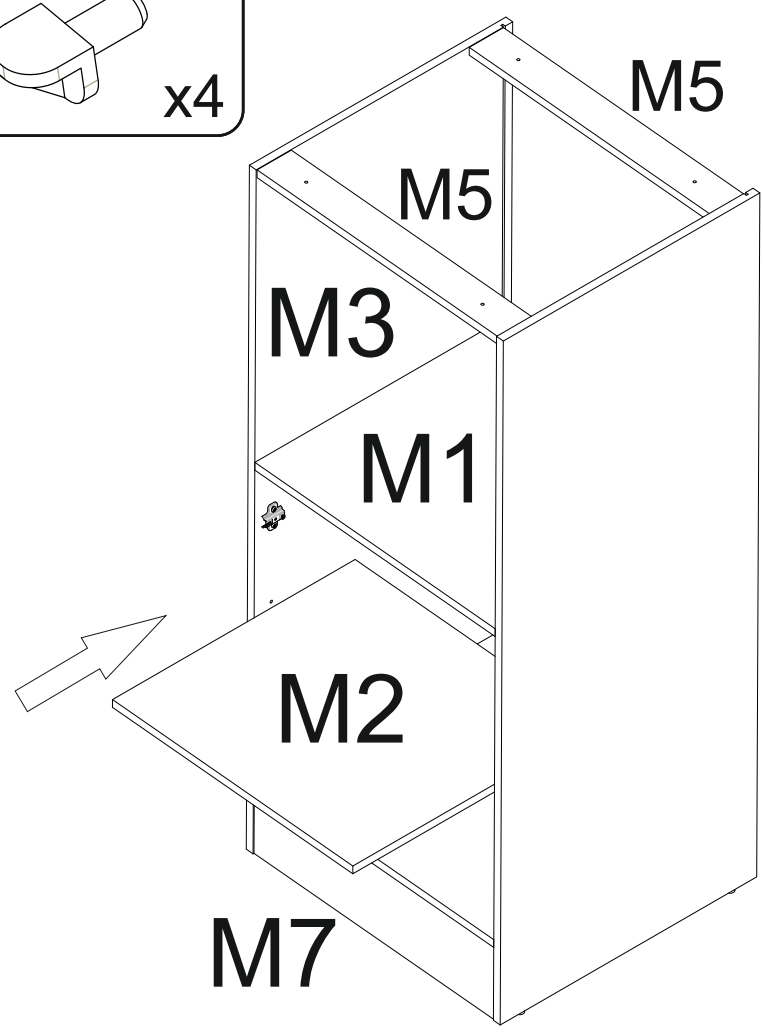

9

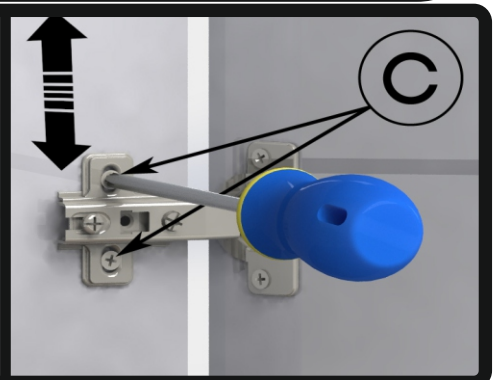
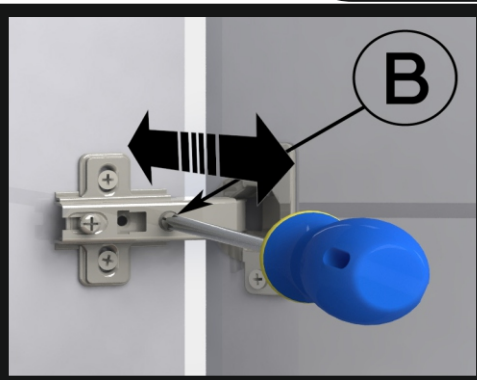
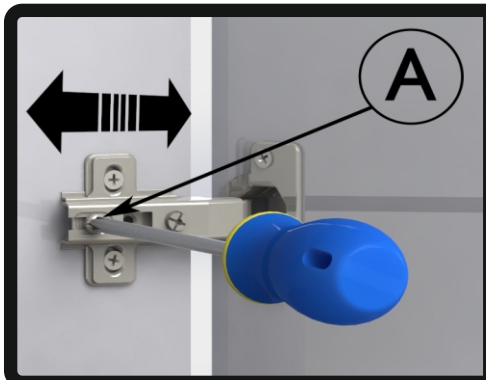
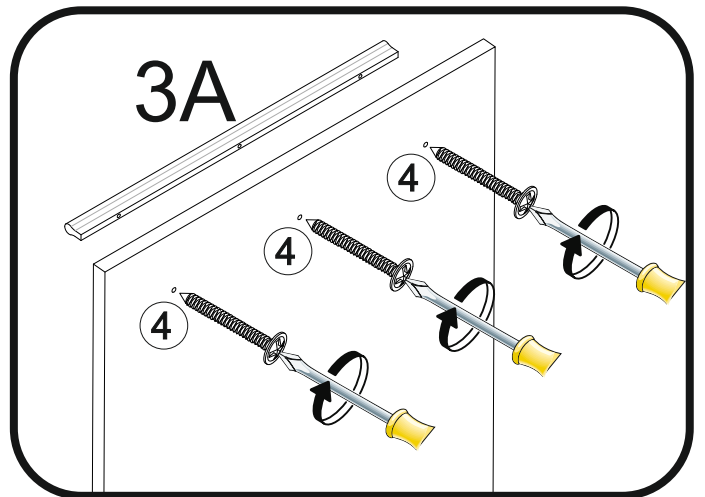
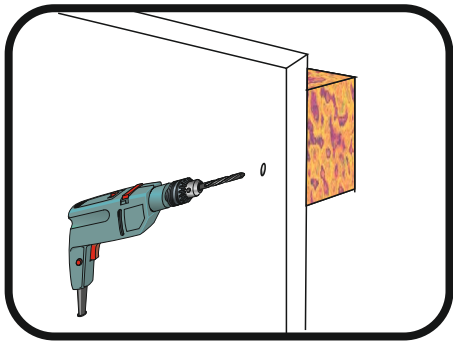
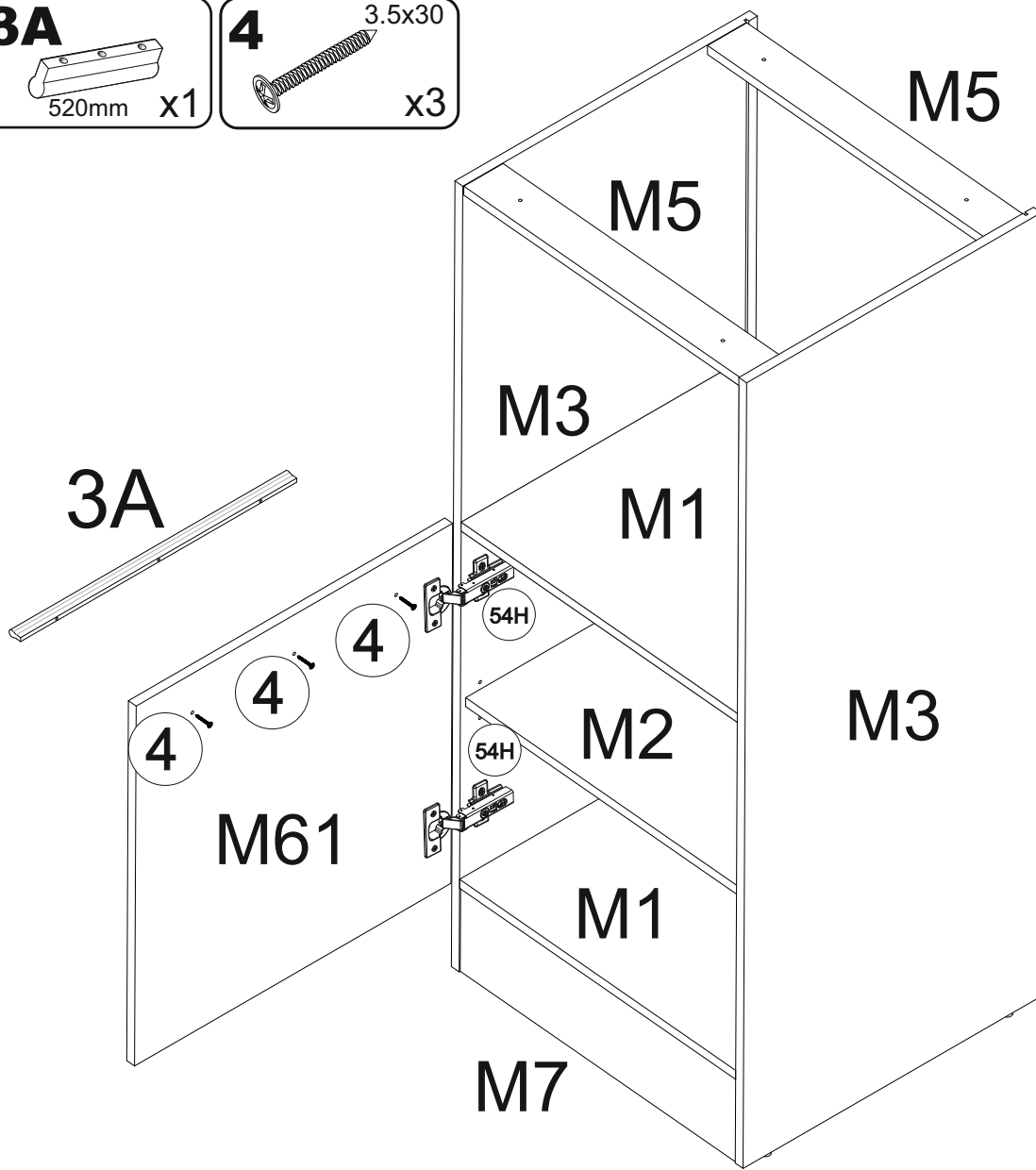
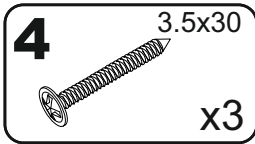
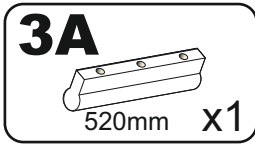

1

A3	500x330
----	---------

A4	500x330
----	---------

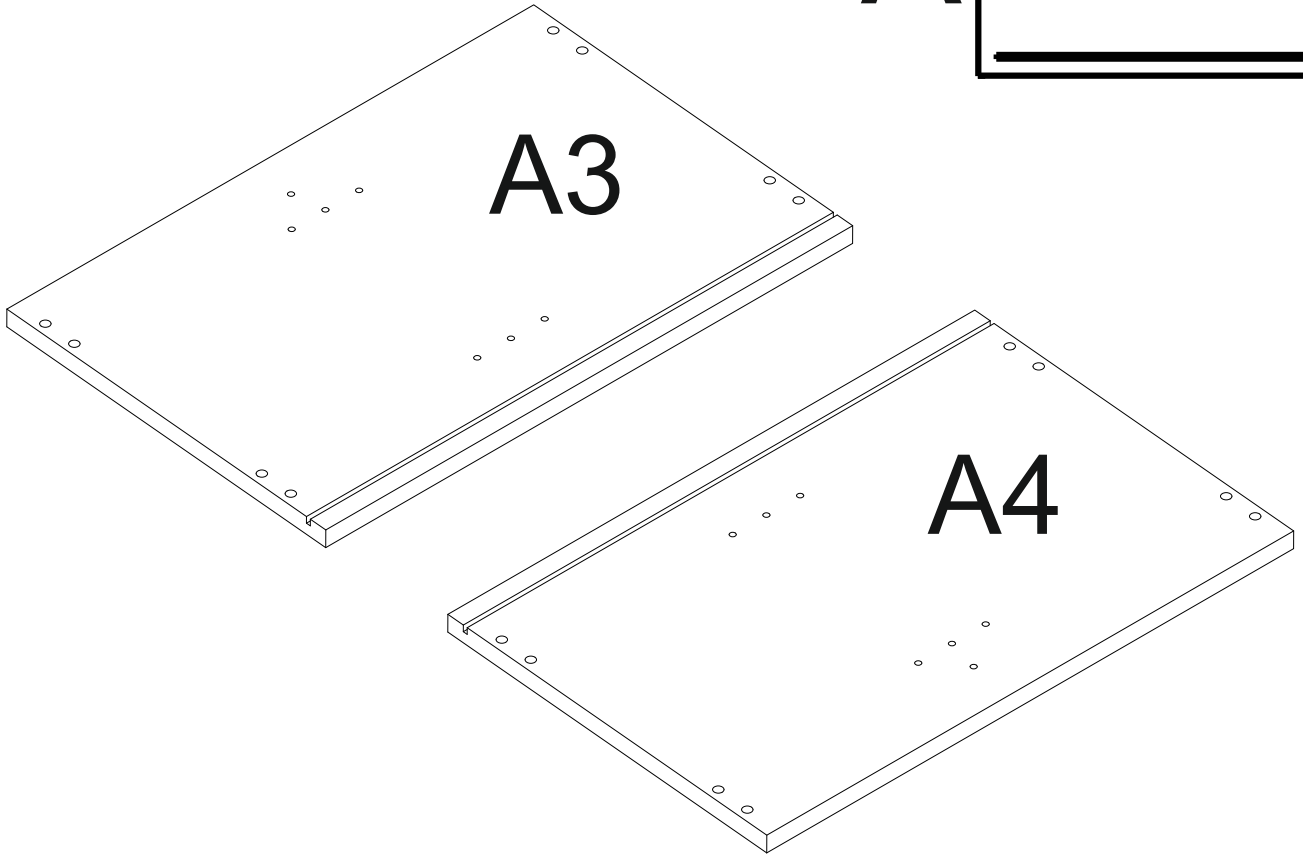
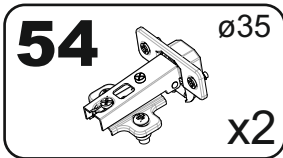
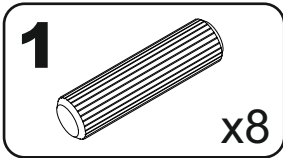
A**2**

A1	867x310
----	---------

A2	867x310
----	---------

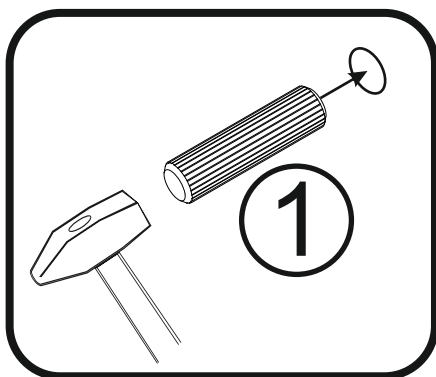
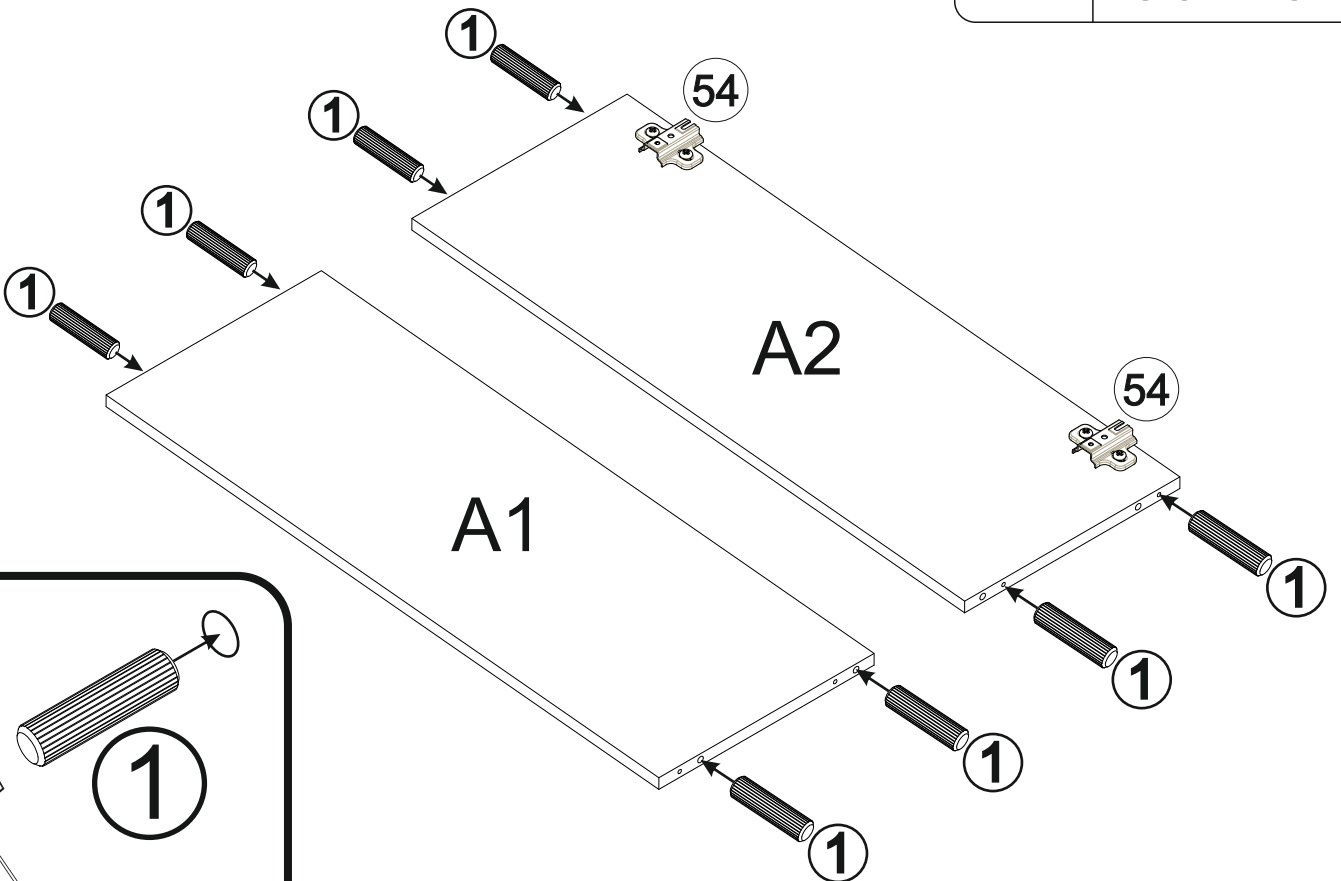

3

54

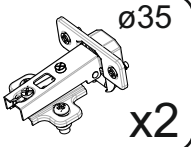

6

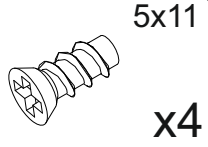

A6

896x496

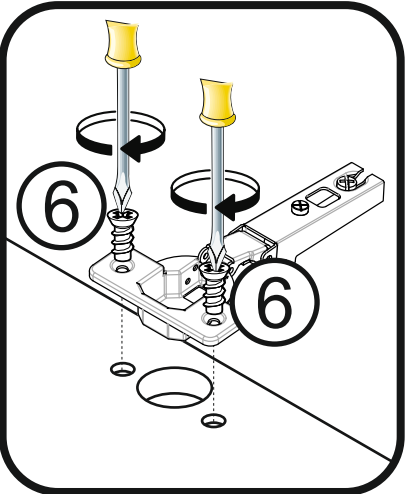
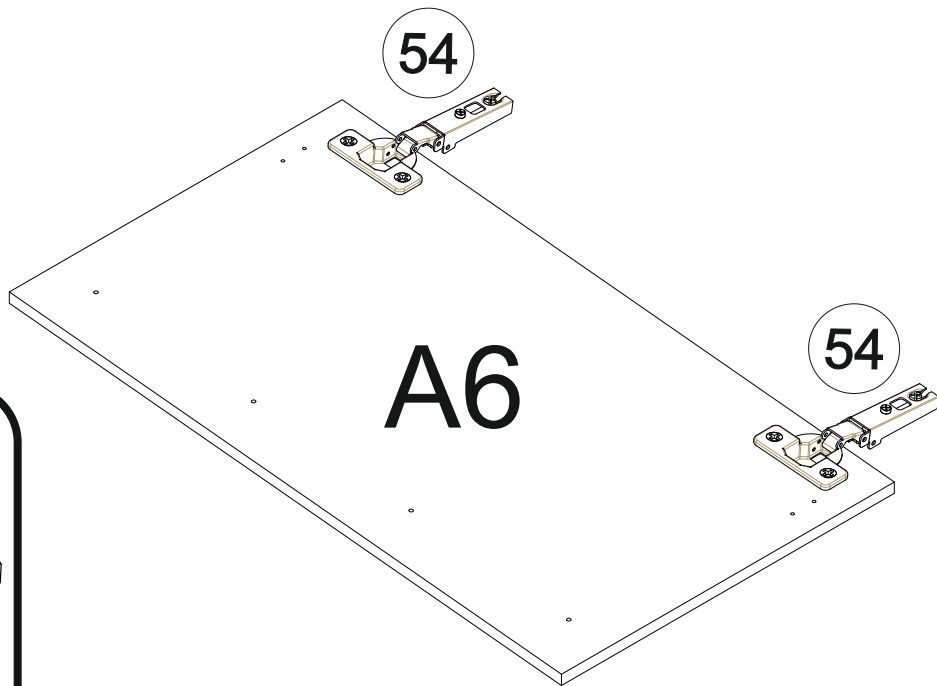

4

22

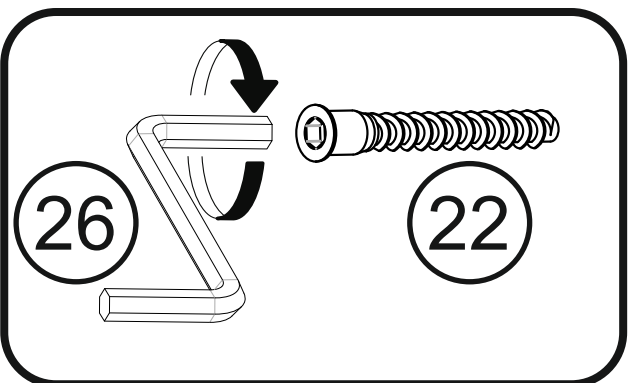
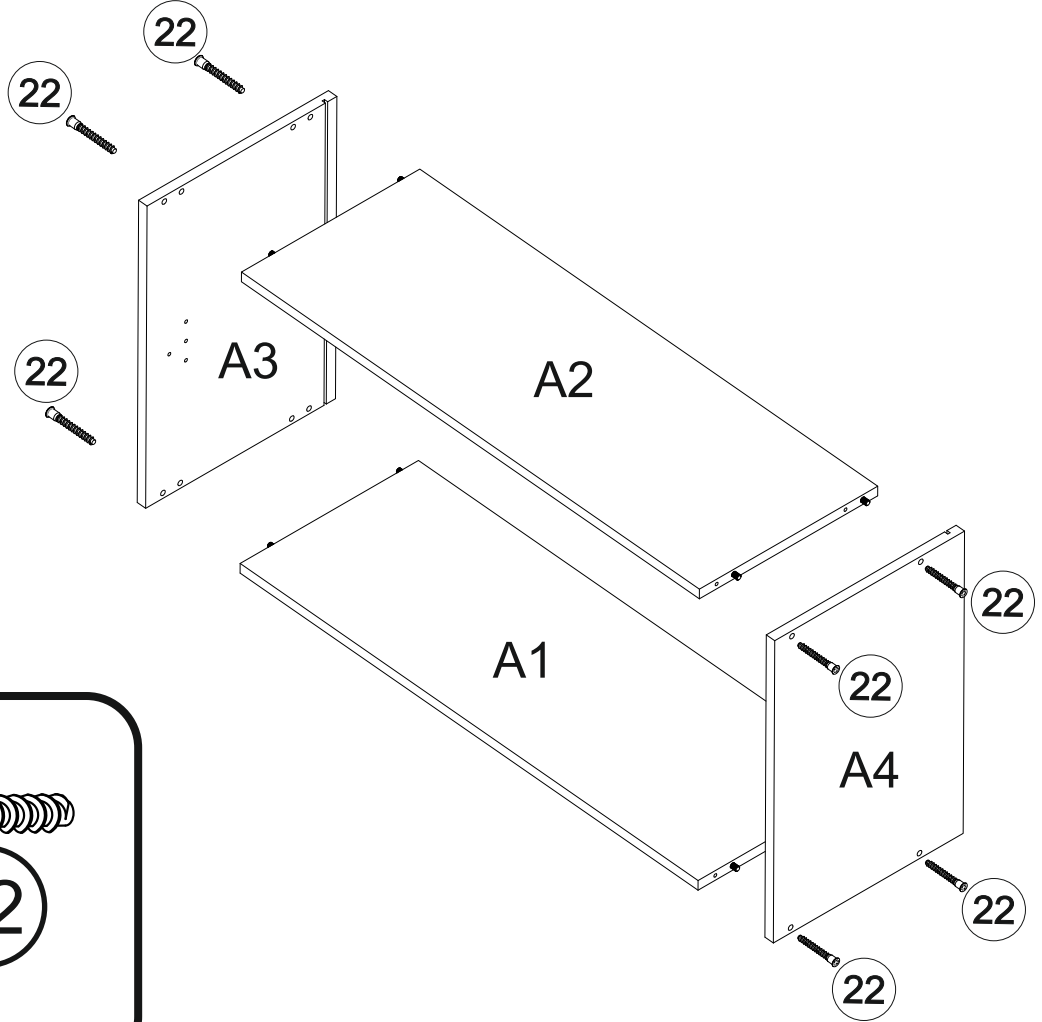
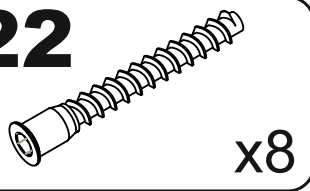

5

A8 | 495x877

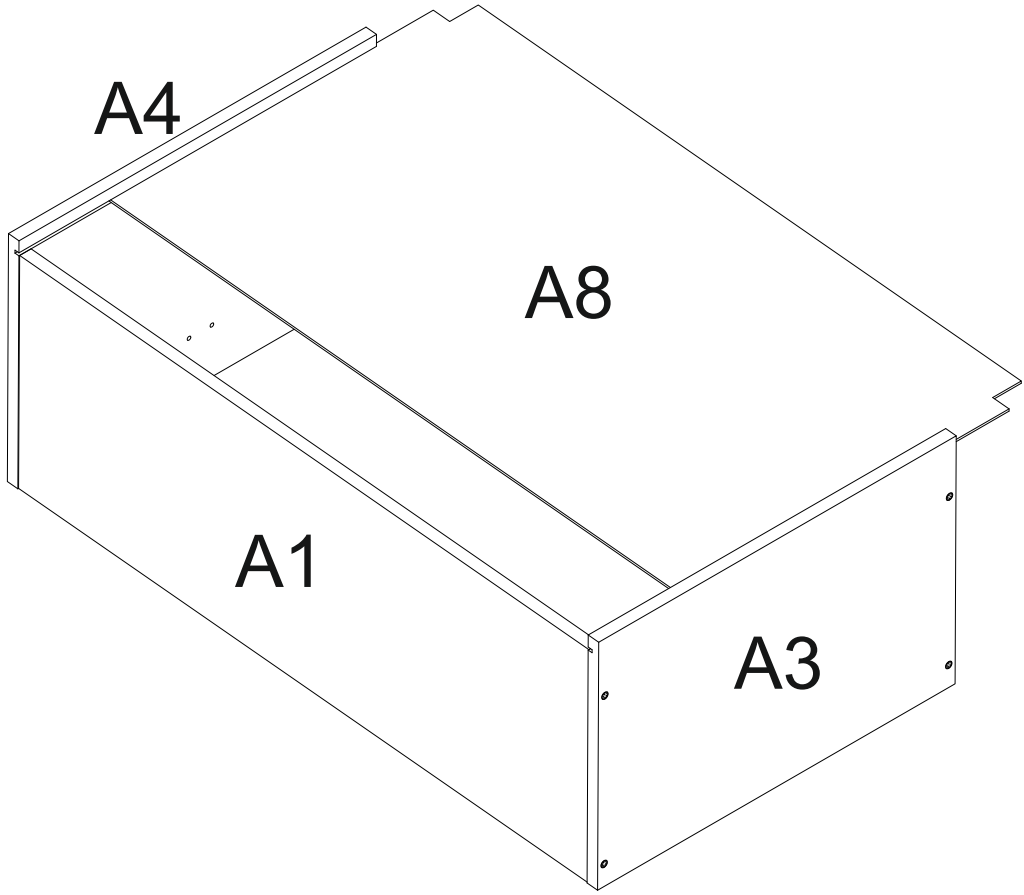

6

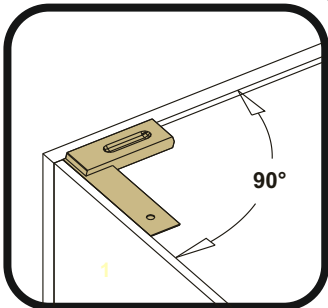
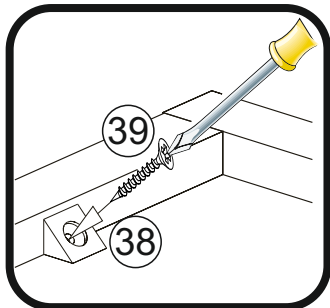
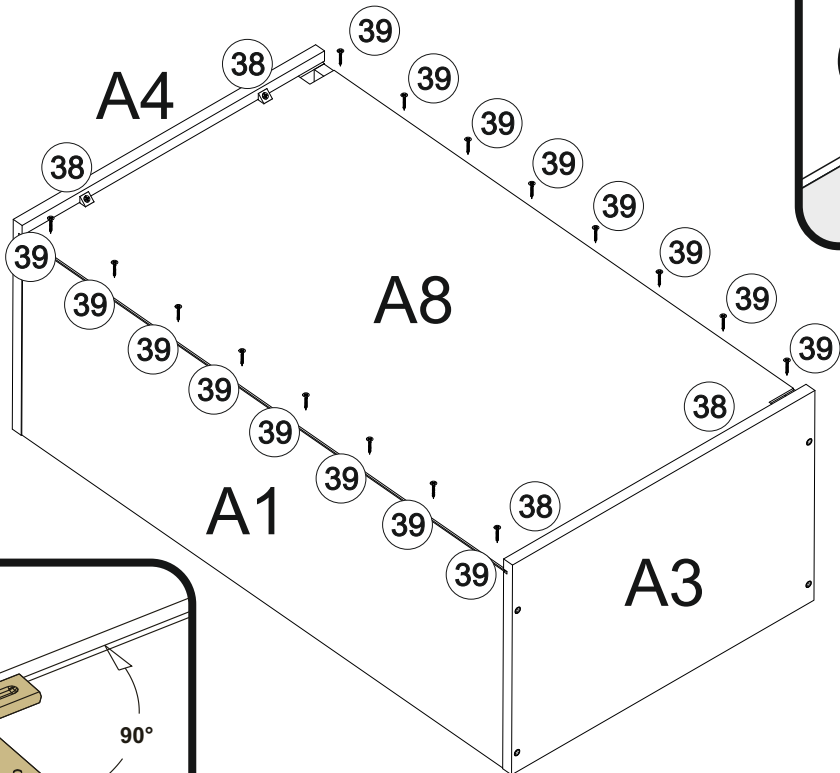
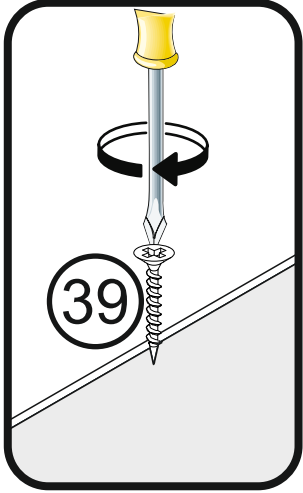
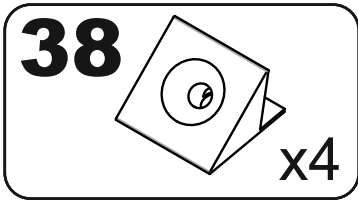
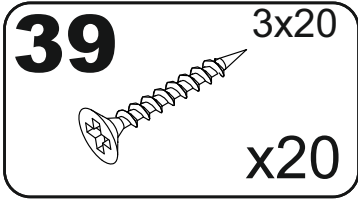

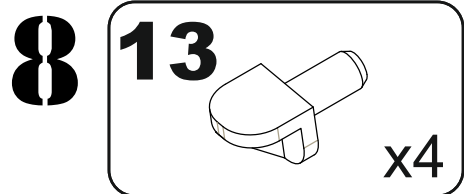
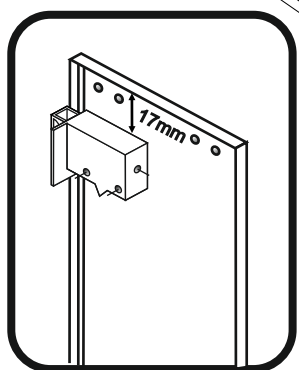
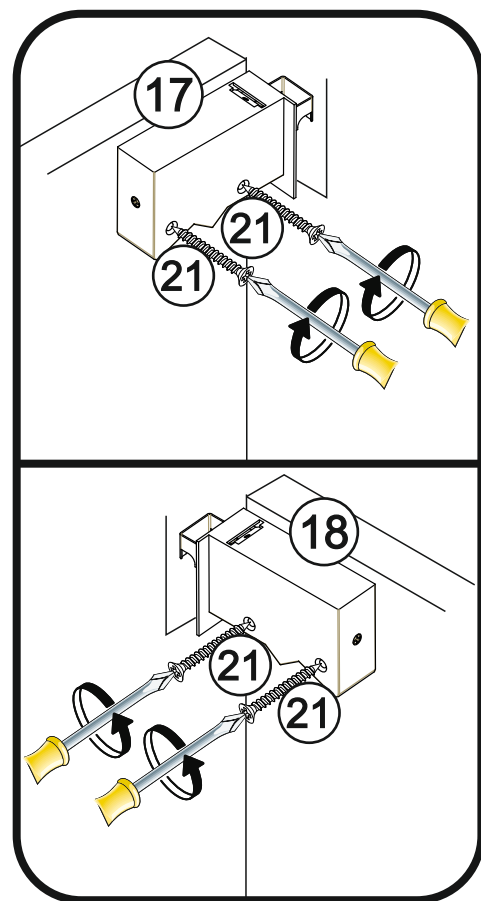
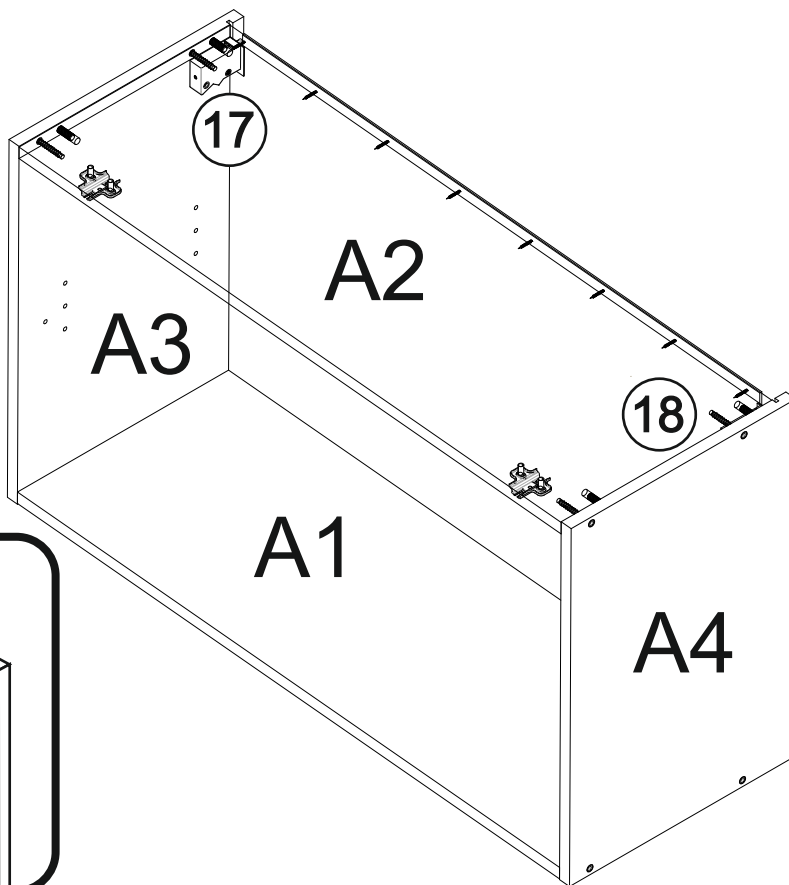
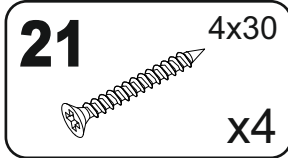
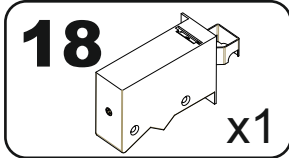
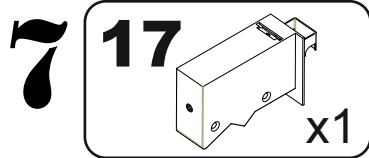

A10 867x246

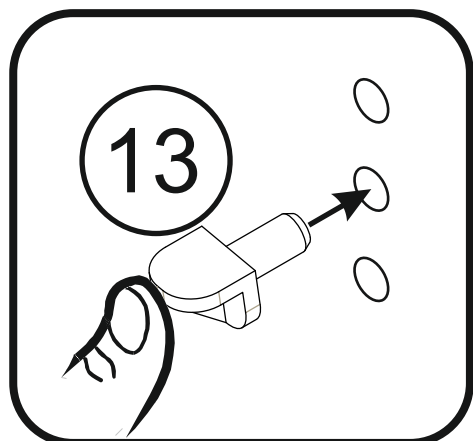
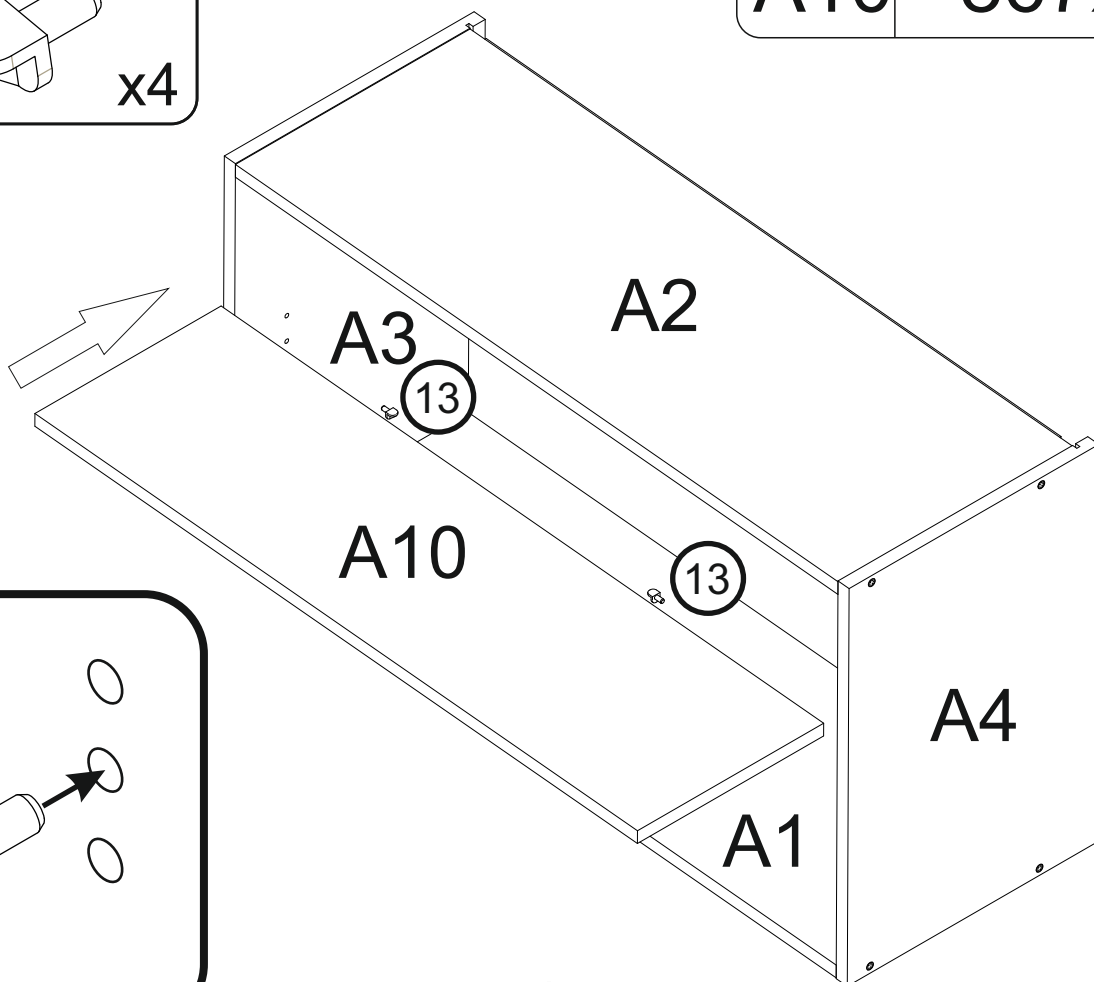

9

3B

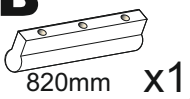

820mm x1

4

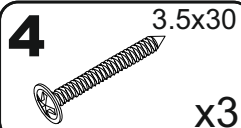

3.5x30 x3

3B

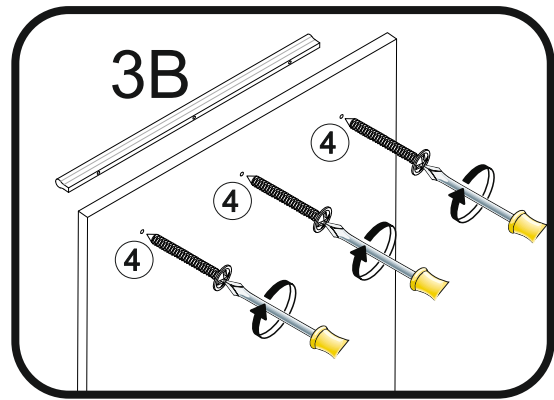
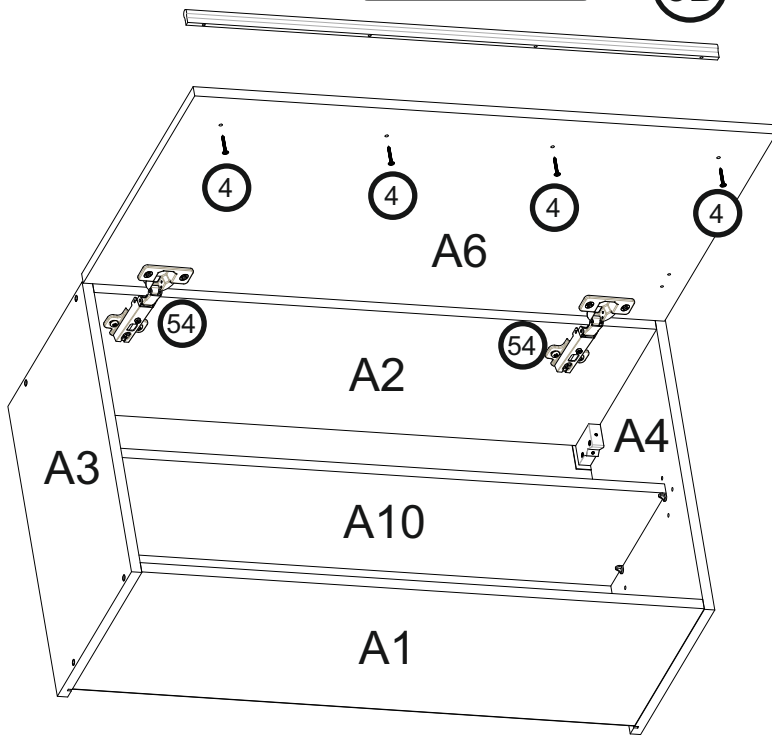

3B

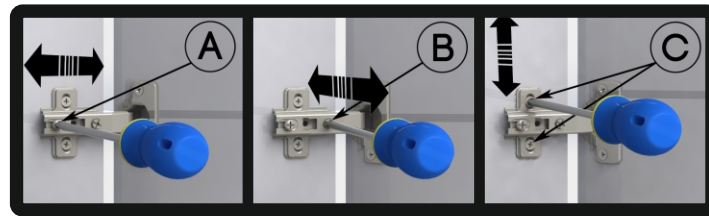
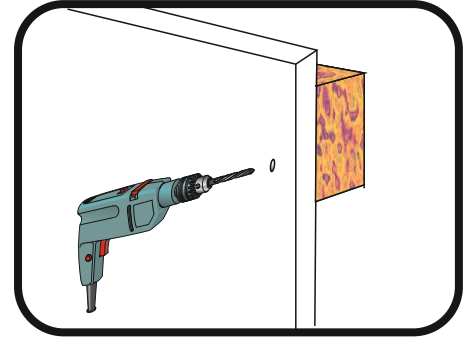
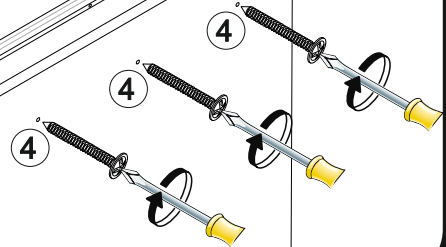

10

76A

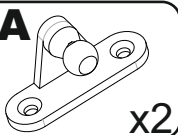

x2

76B

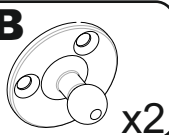

x2

76C

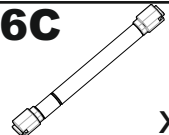

x2

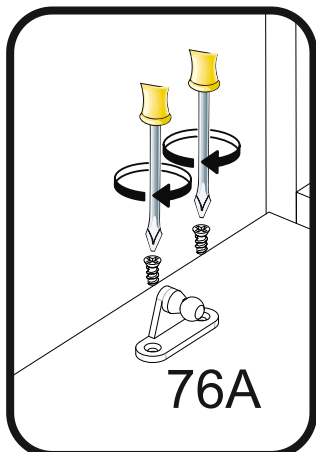
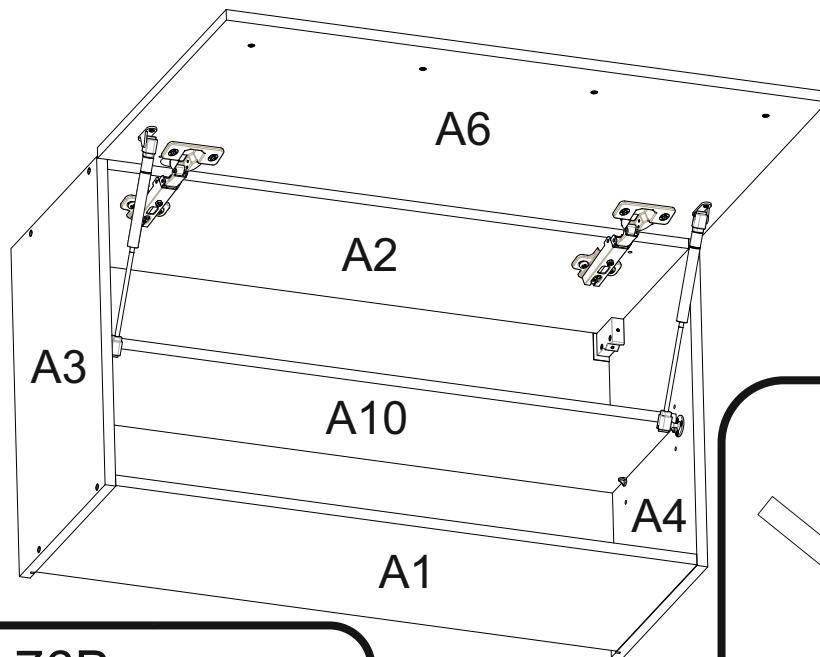

76A

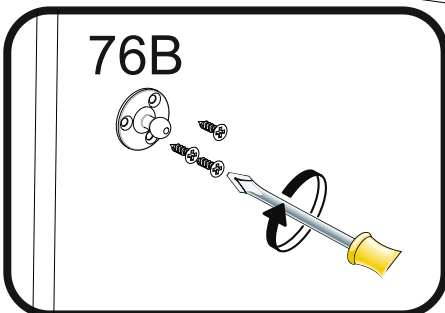

76B

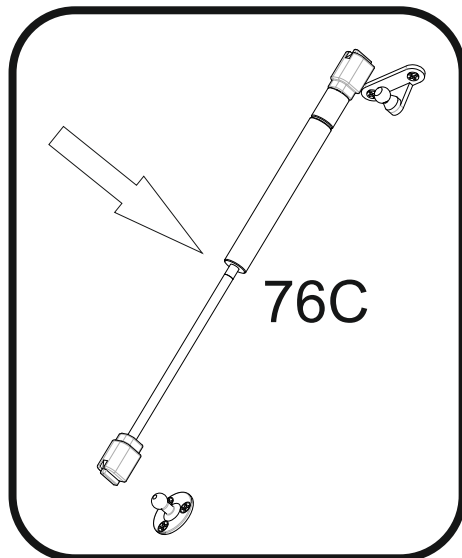

76C

11

80

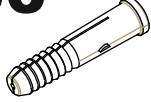

x4

94



x2

80B

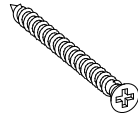

x4

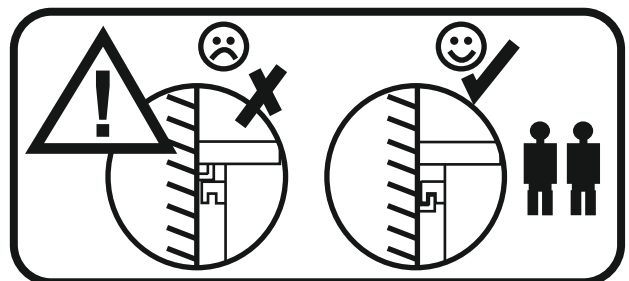
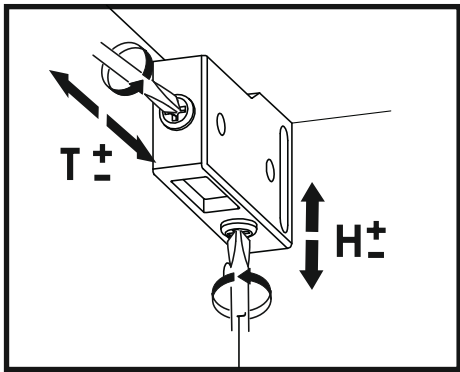
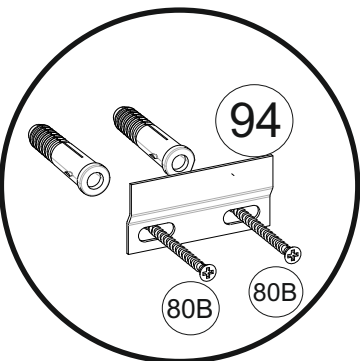
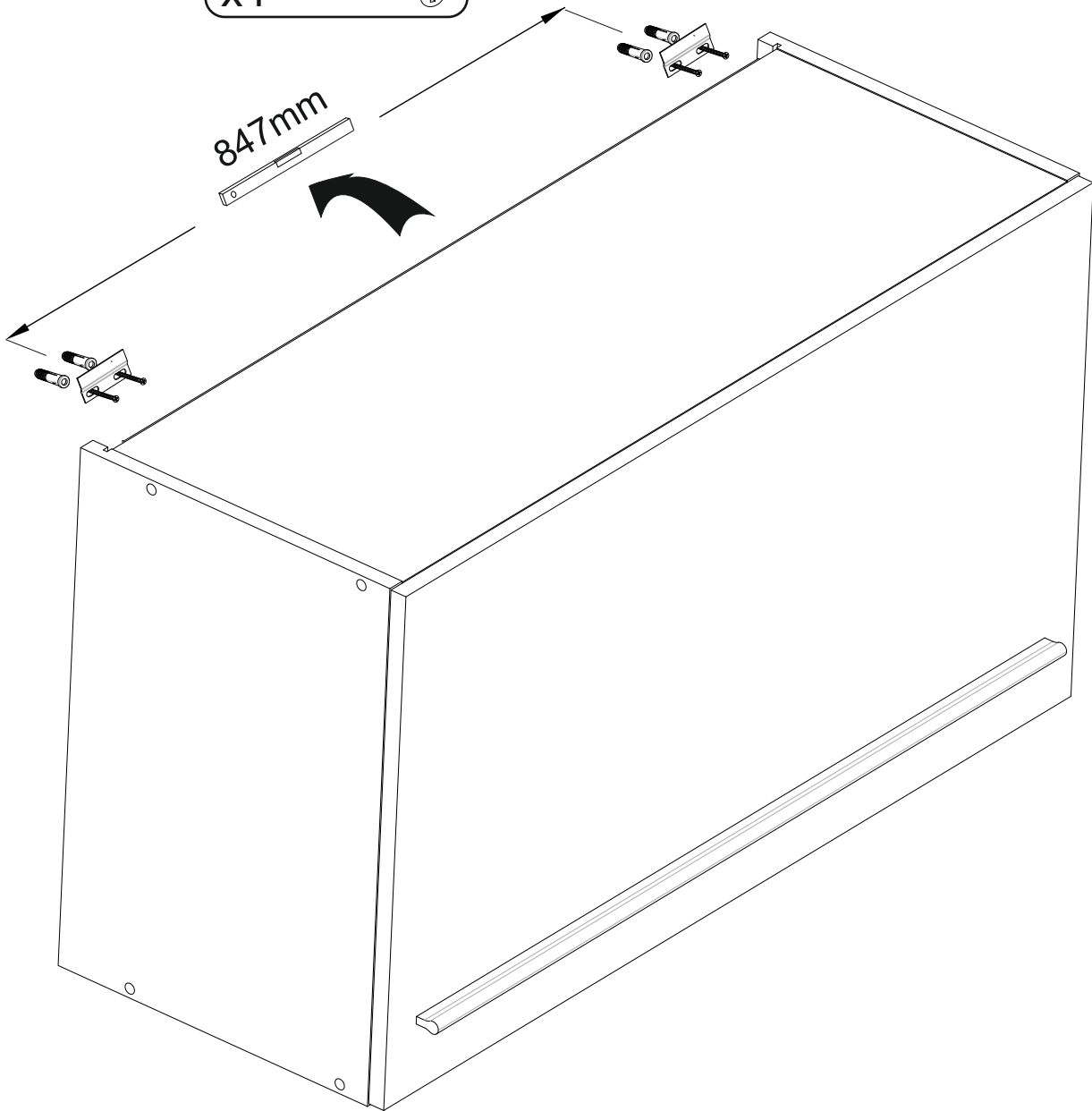
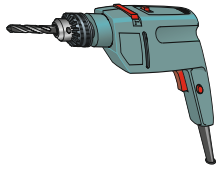
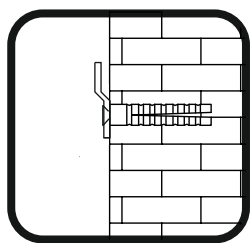
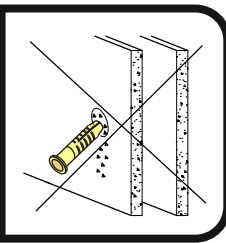
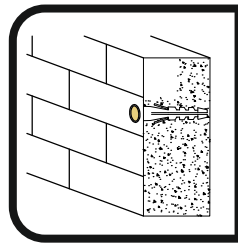

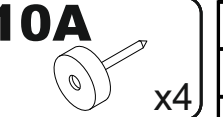
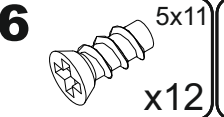
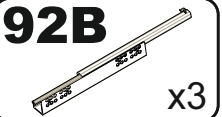
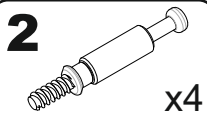
1

P3 870x555

P4 870x555

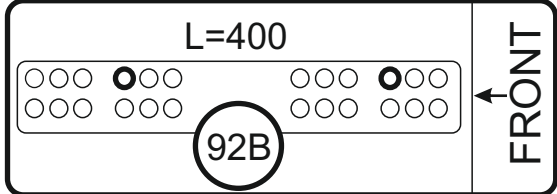
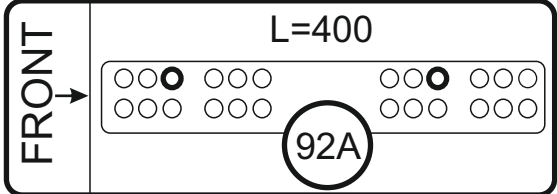
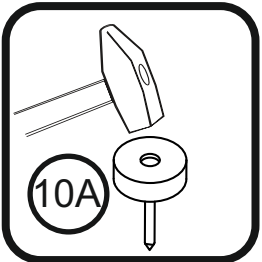
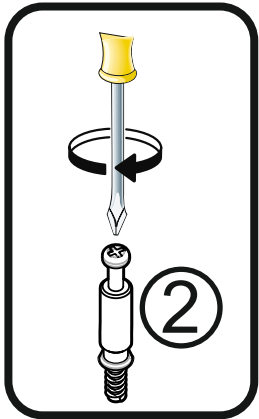
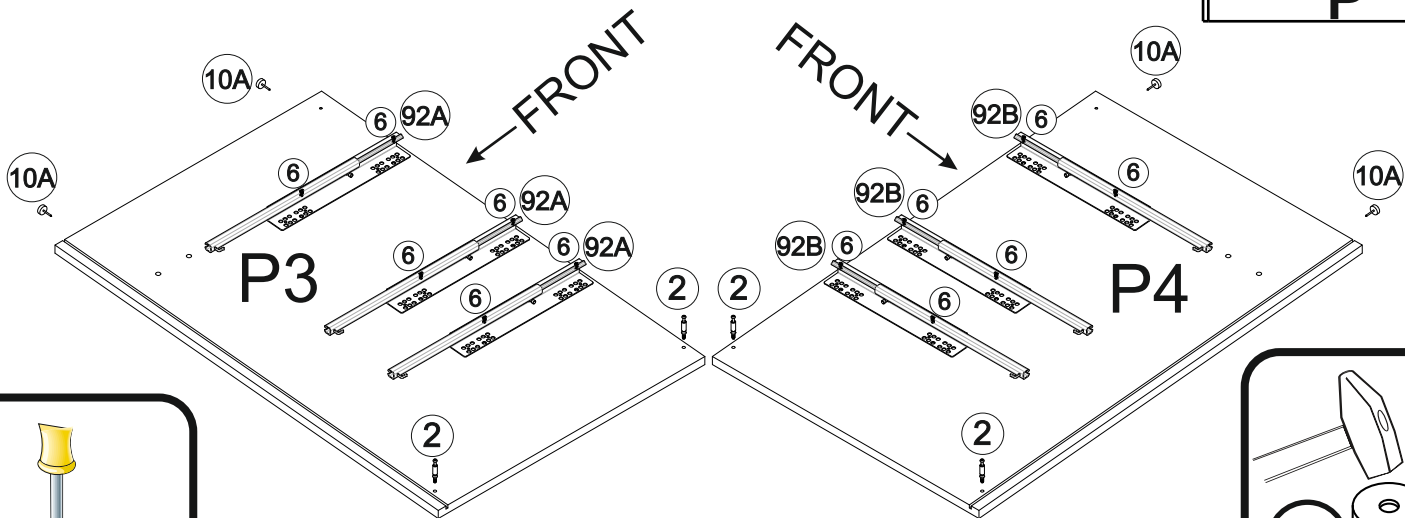
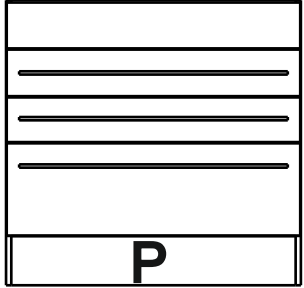
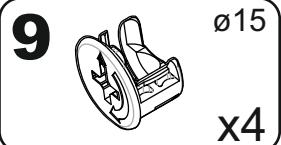
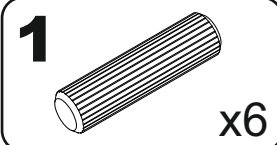
**2**

P1	867x535
P8	867x74

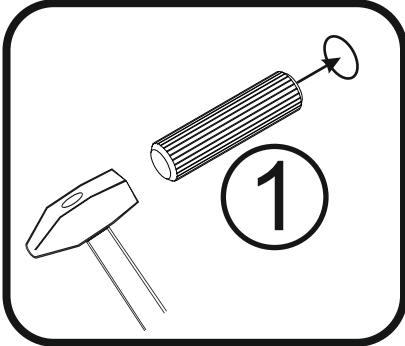
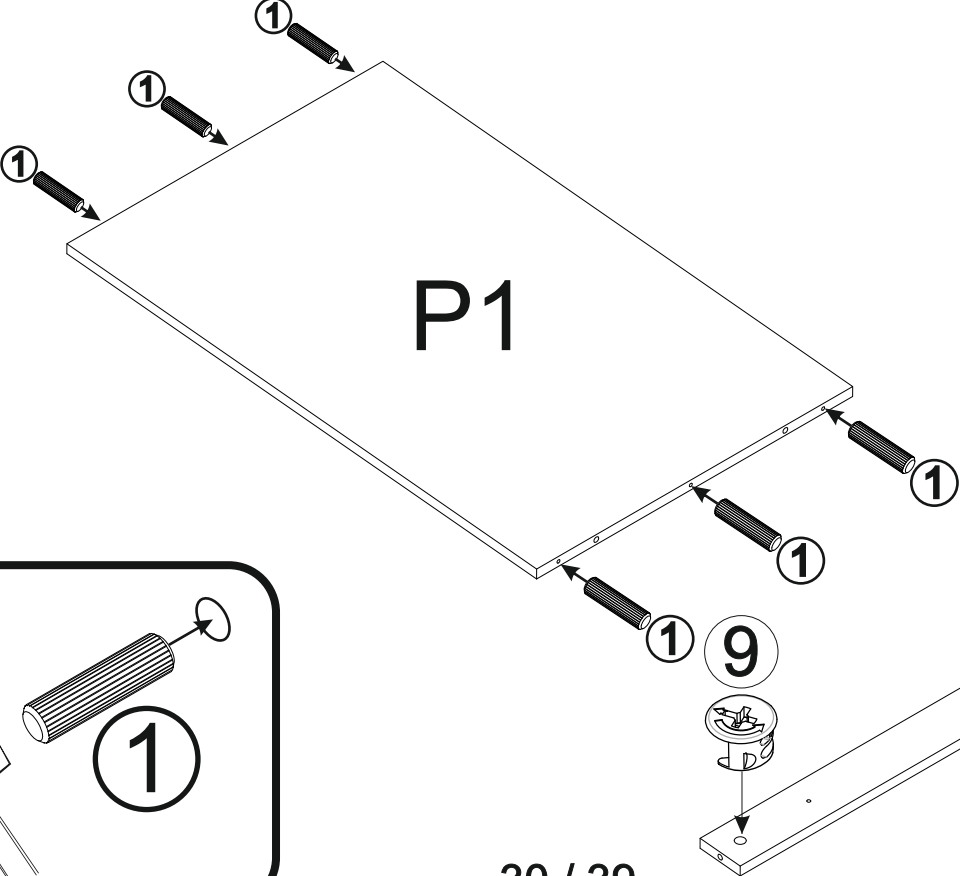
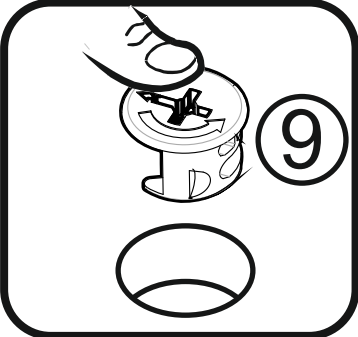

3

22

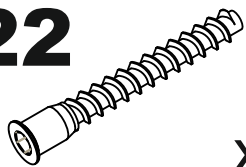

x4

22

22

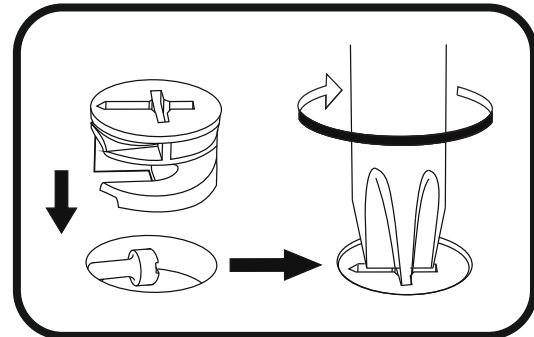
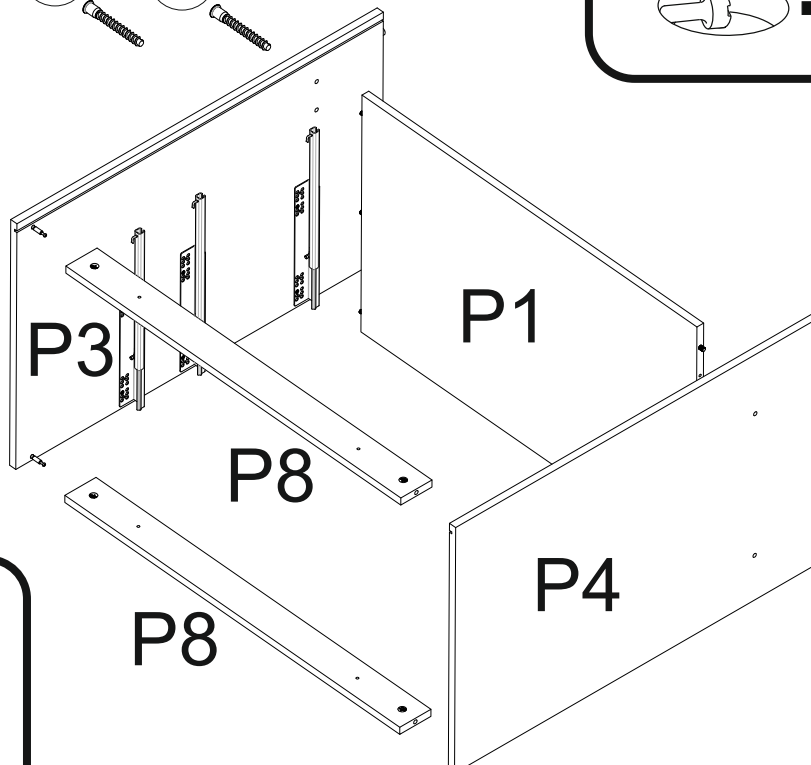

26

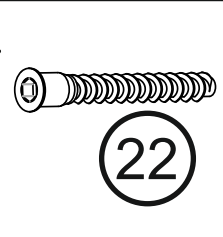

22

22

22

4

31C

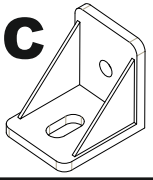

x3

4A

4x16

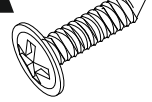

x6

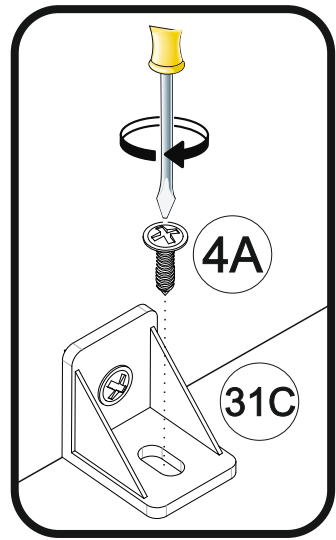
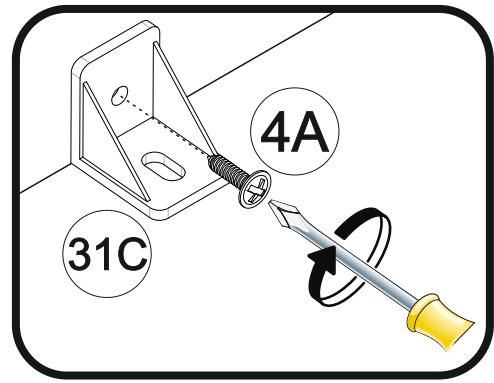
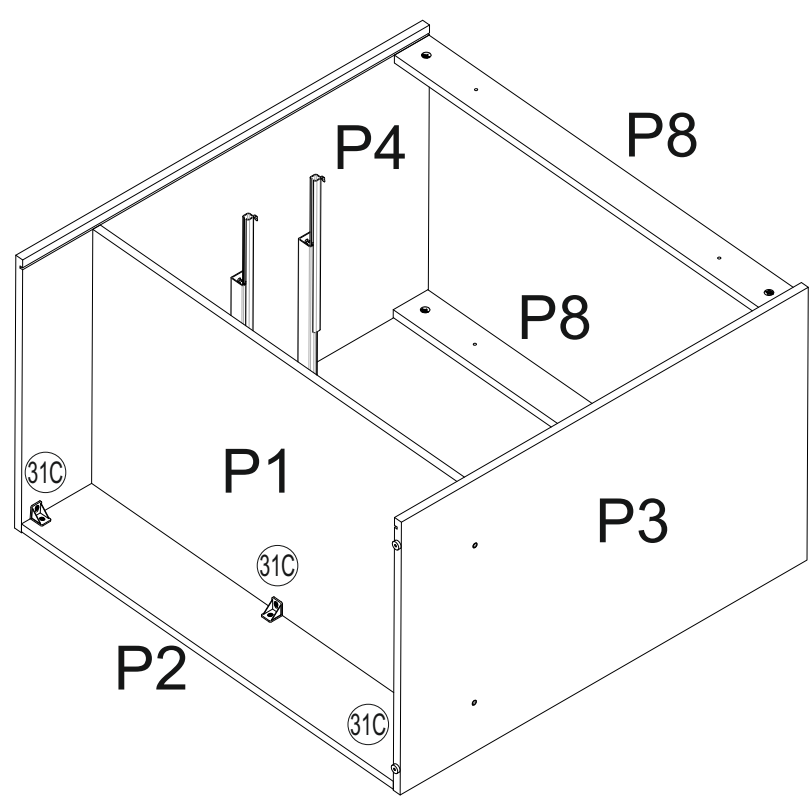

5

P7 358x877

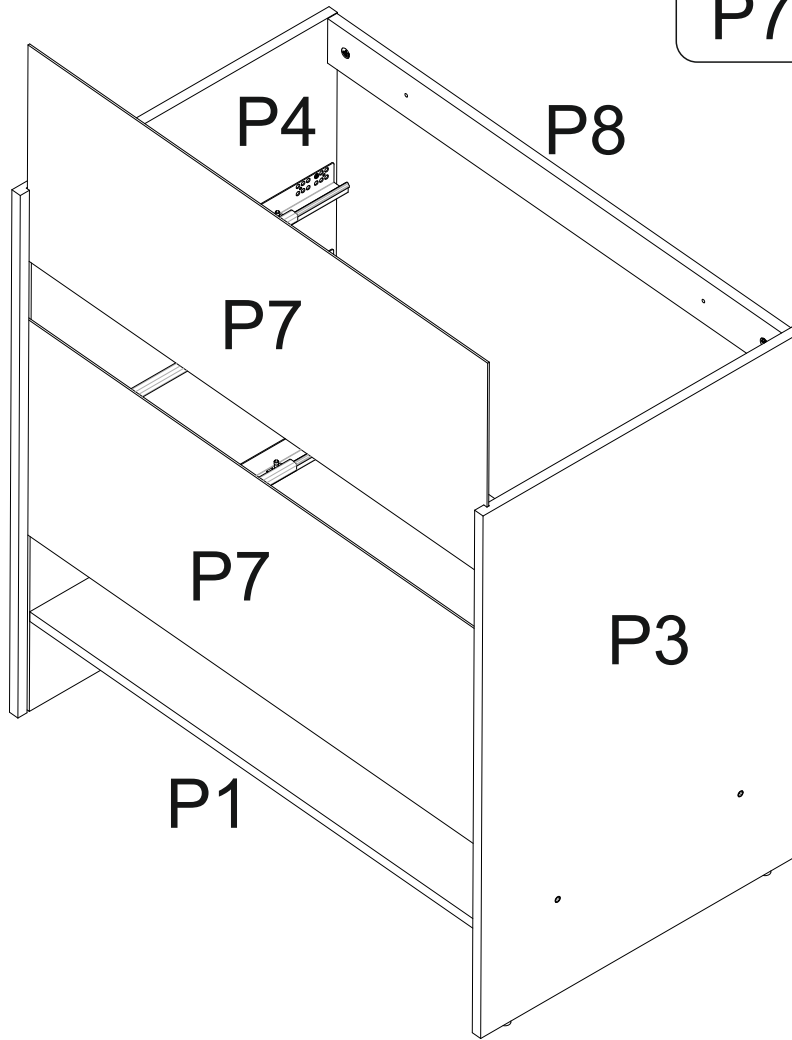

6

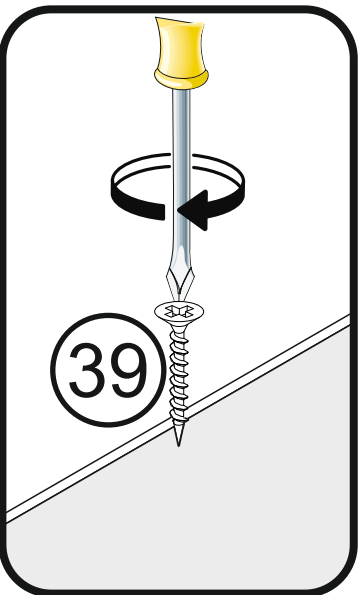
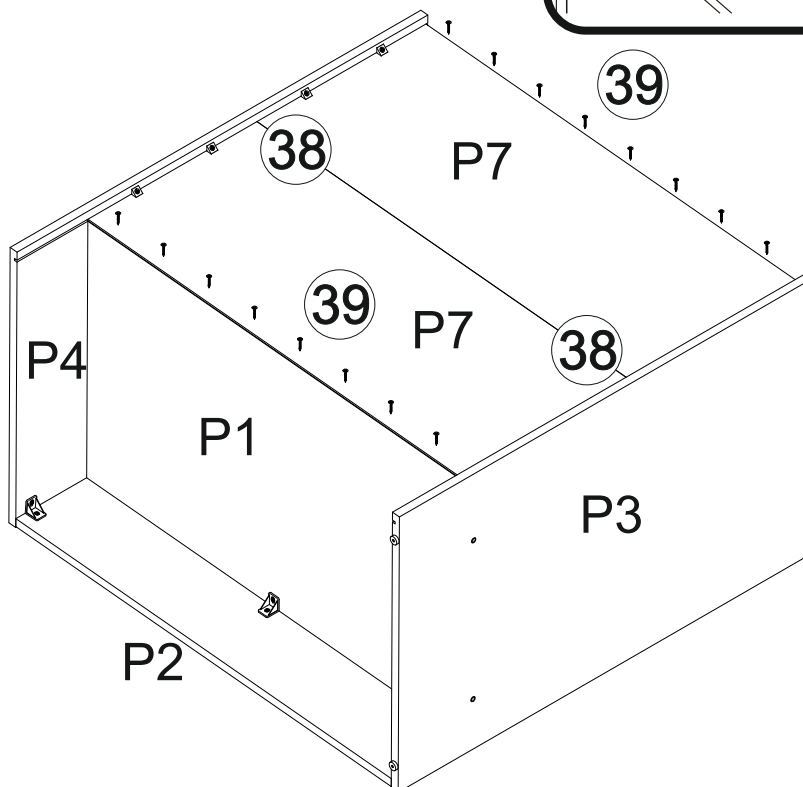
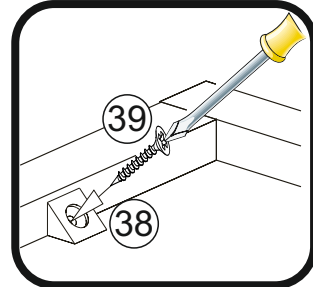
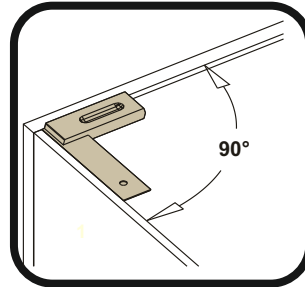
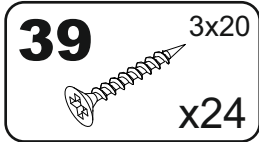
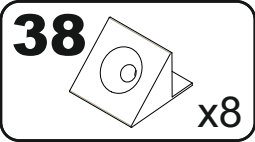

7

2

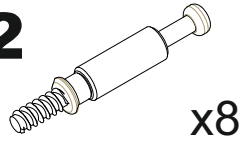

x8

x2

PS1

140x896

PS2

283x896

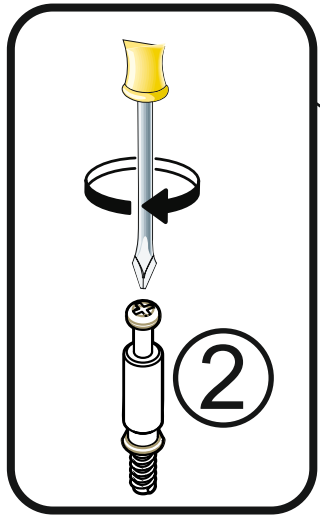
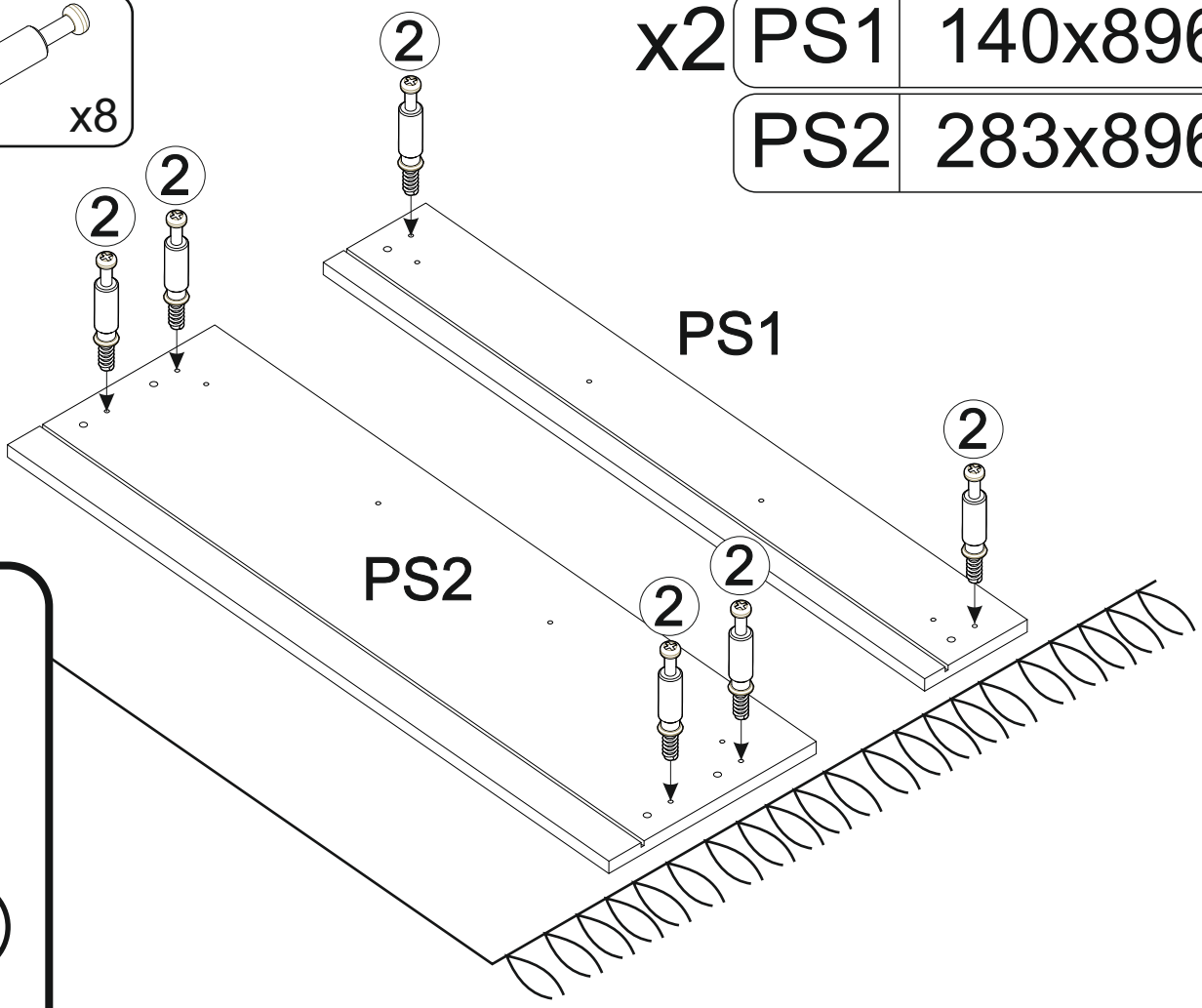

8

1

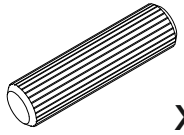

x4

22

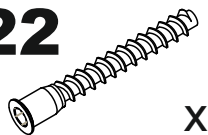

x2

24



x2

PT1

828x82

WQ3

400x96

WQ4

400x96

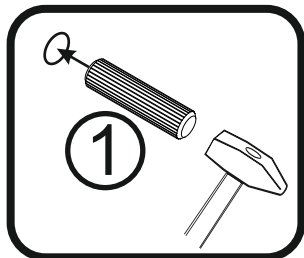
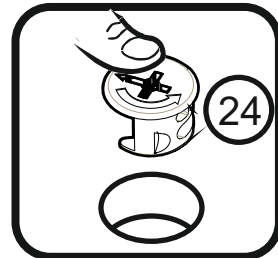
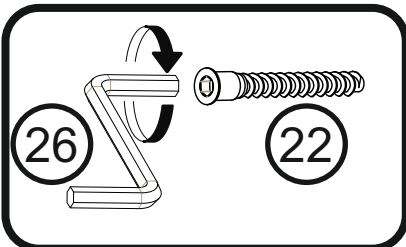
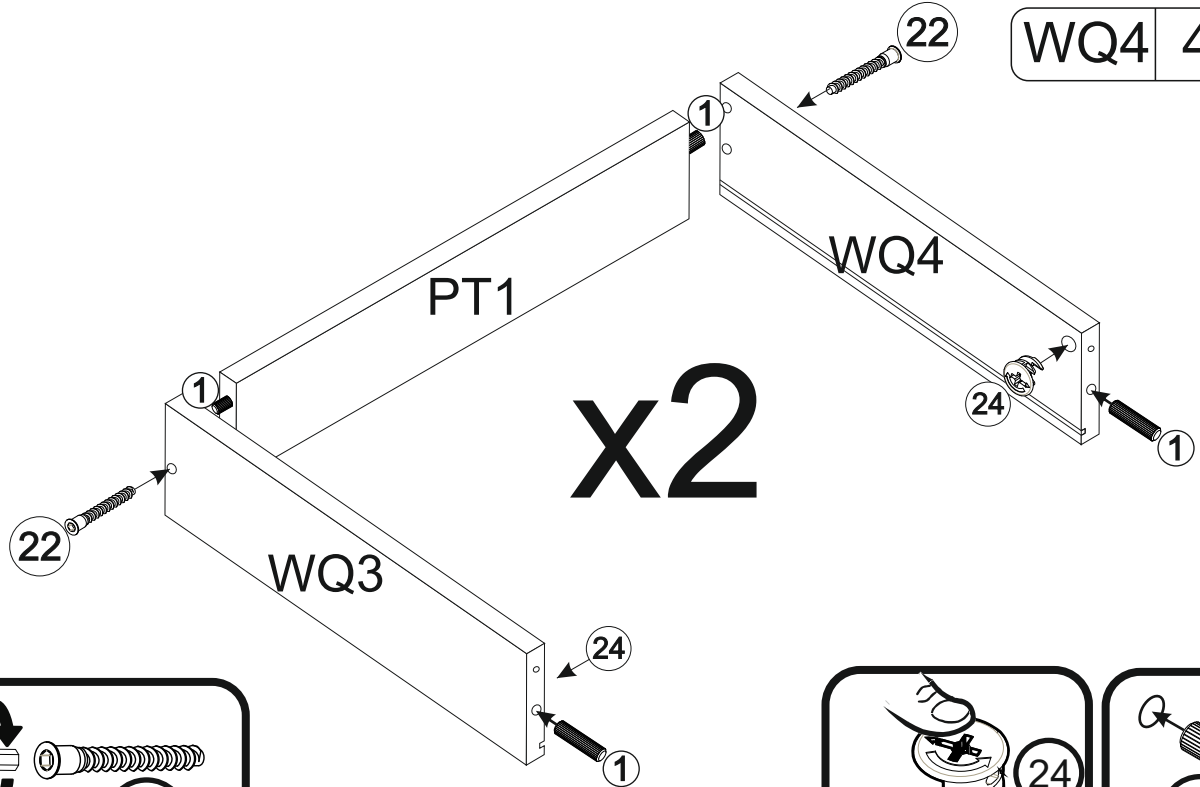

9

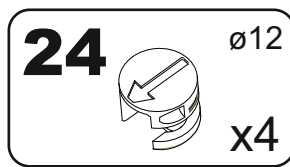
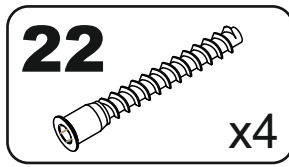
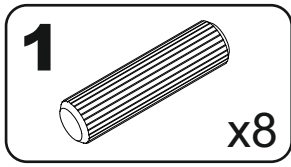

PT2 828x177

WQ3 400x96

WQ4 400x96

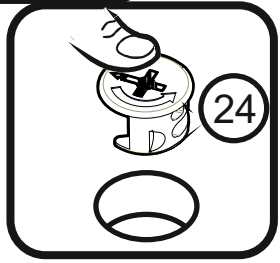
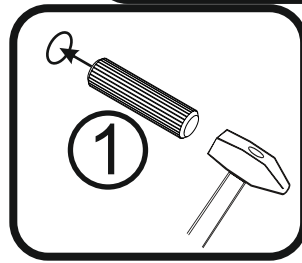
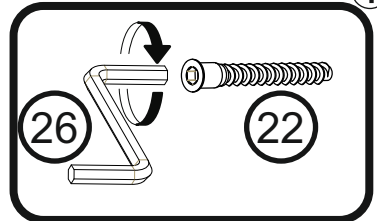
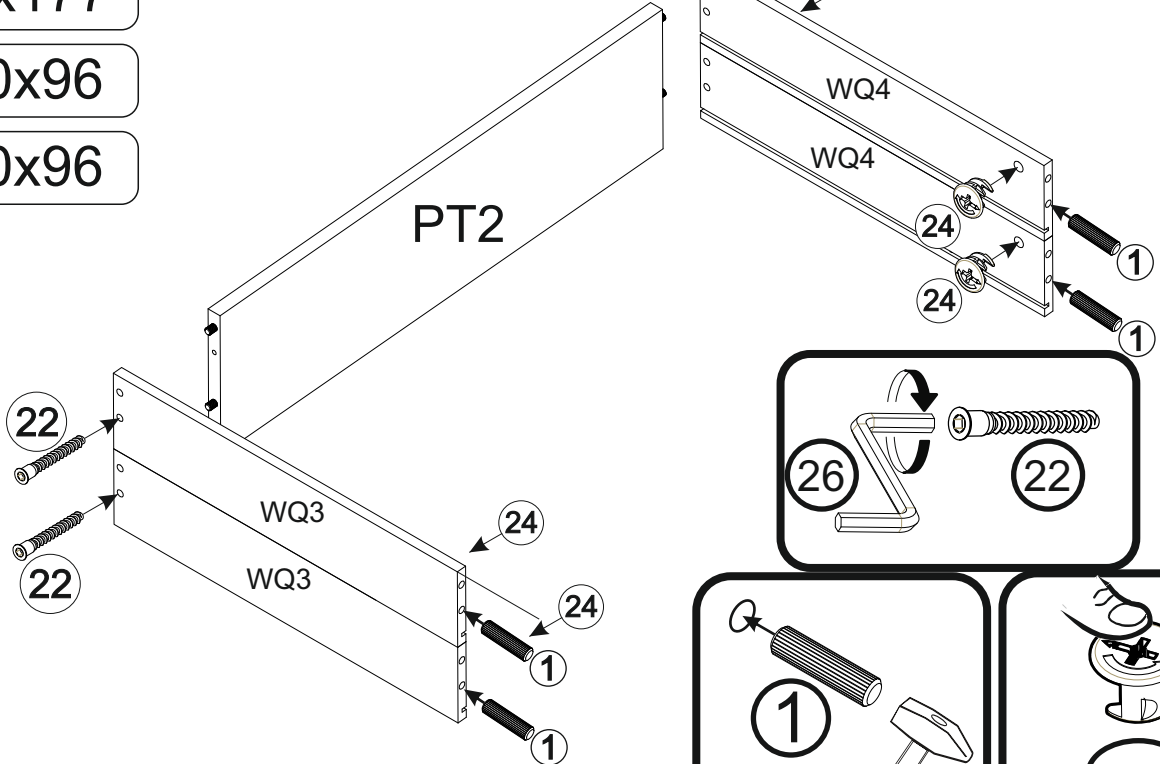

10

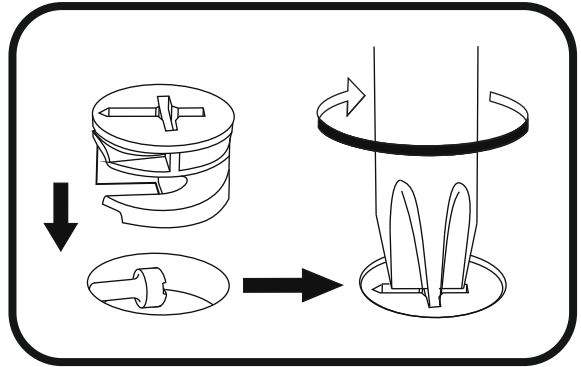
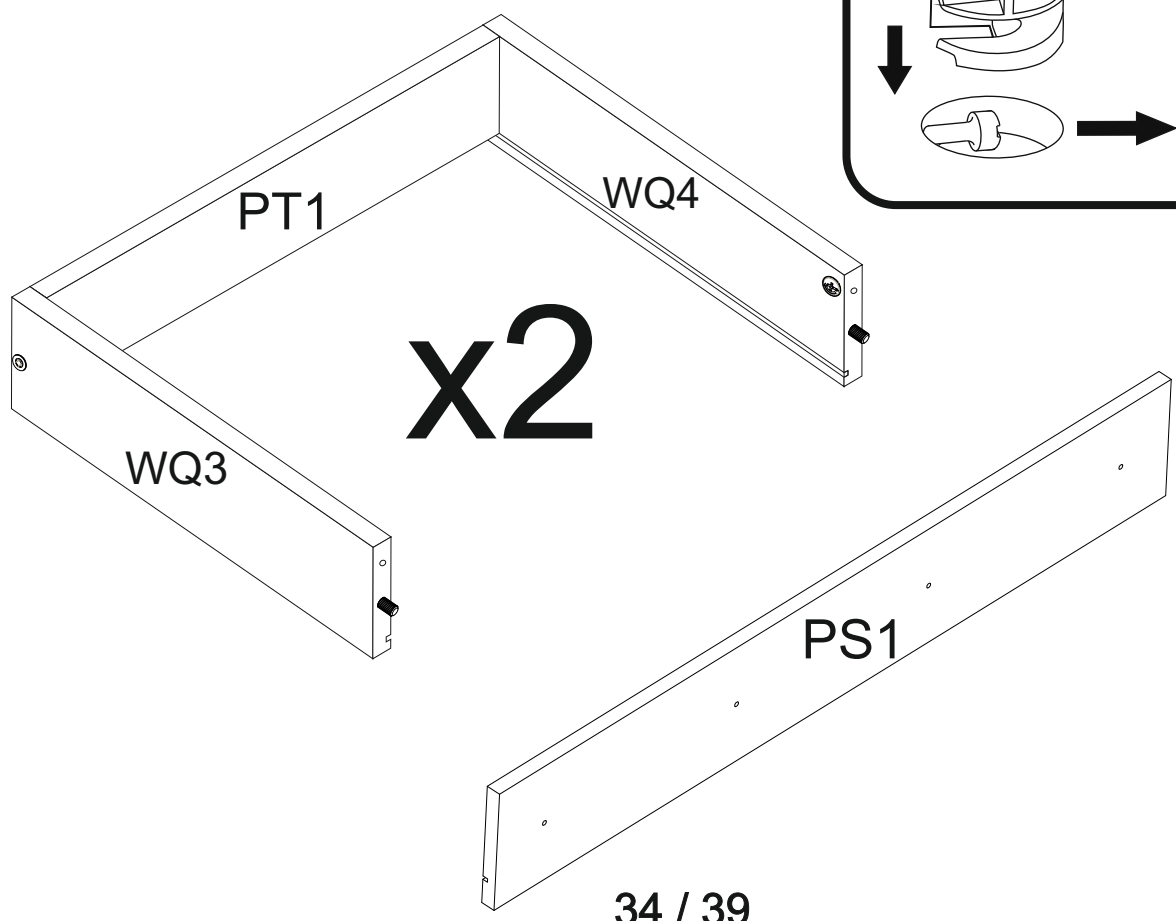

11

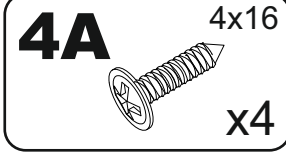
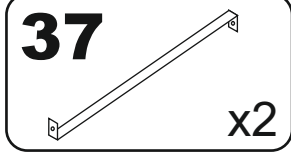
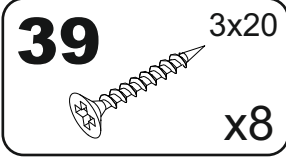

PD1 838x403

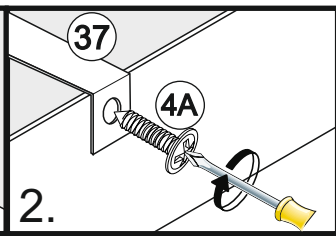
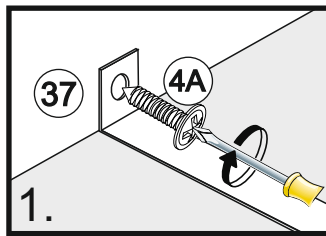
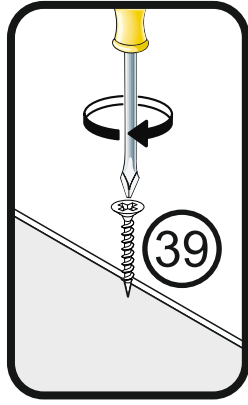
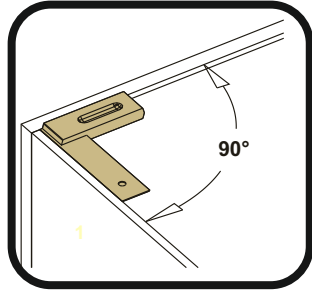
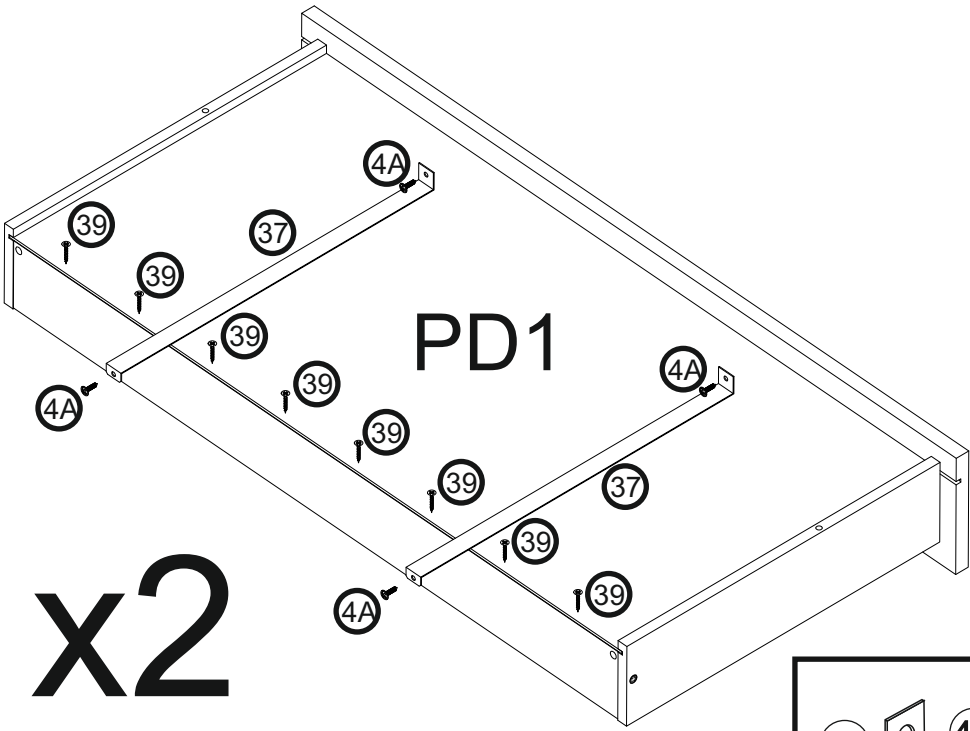

12

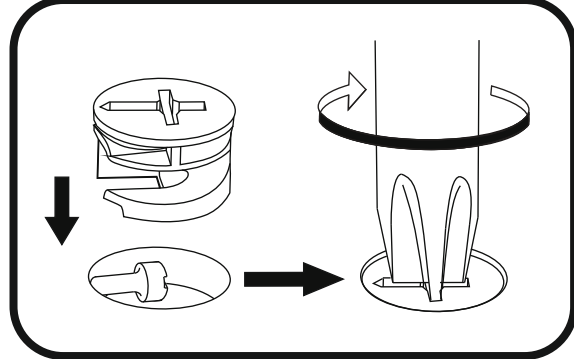
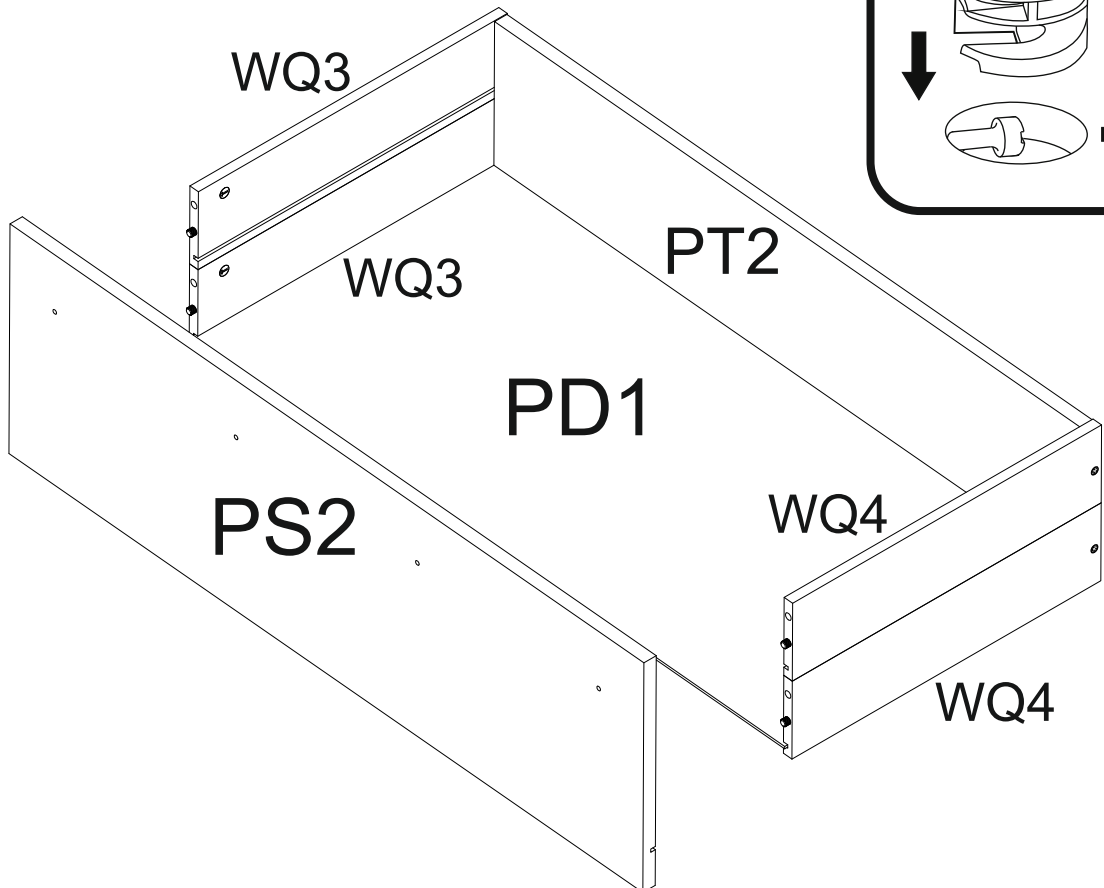

13

39

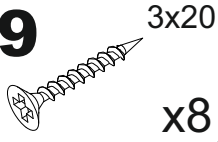

37

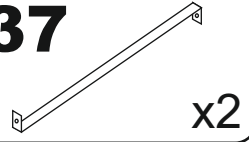

4A

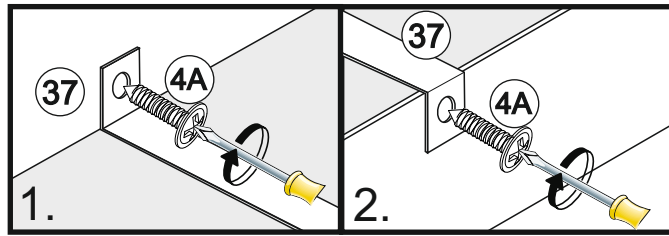
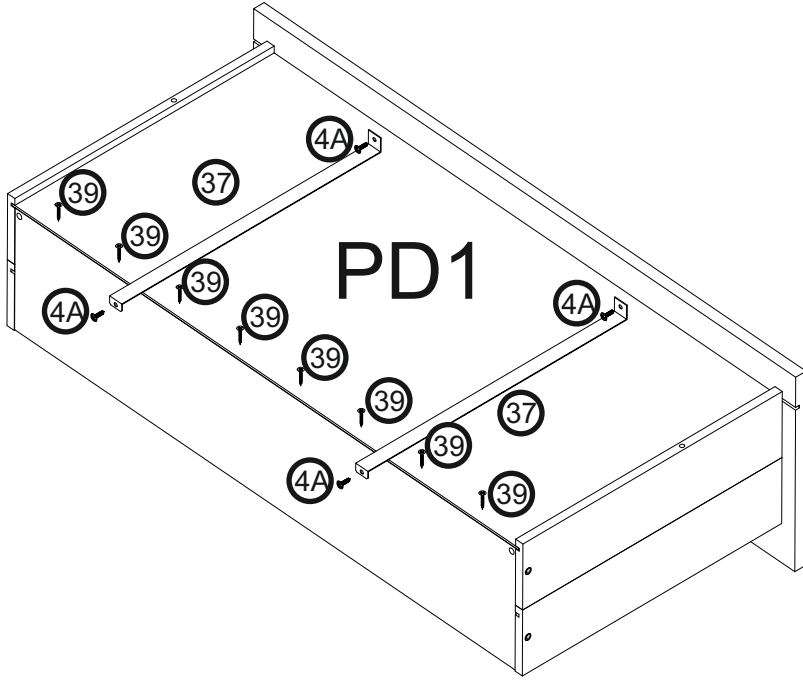
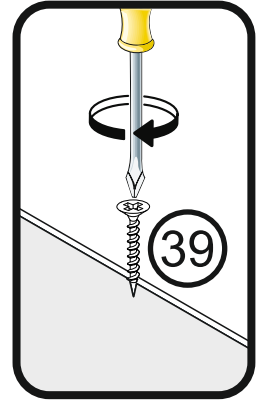
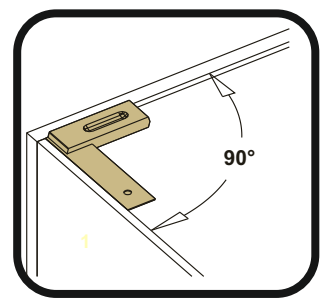
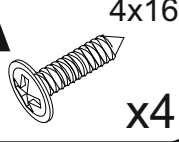

14

3B

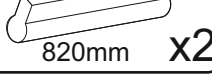

4

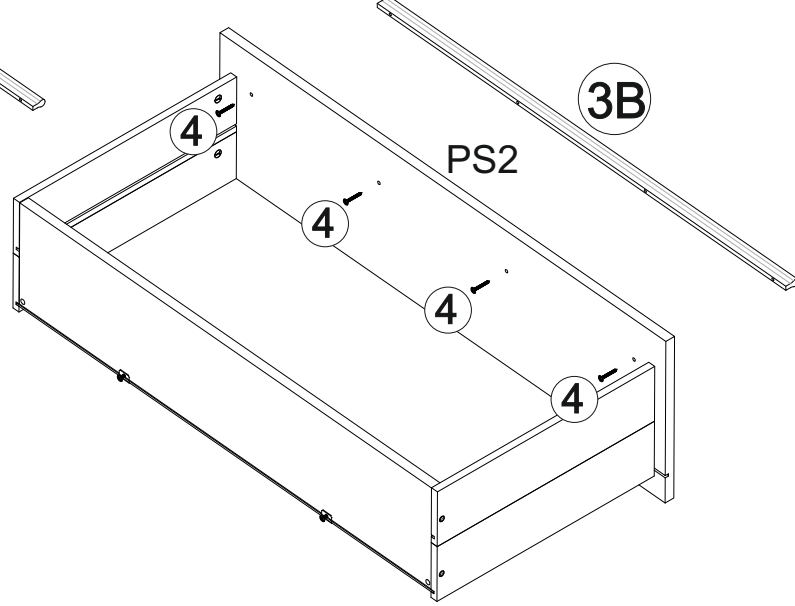
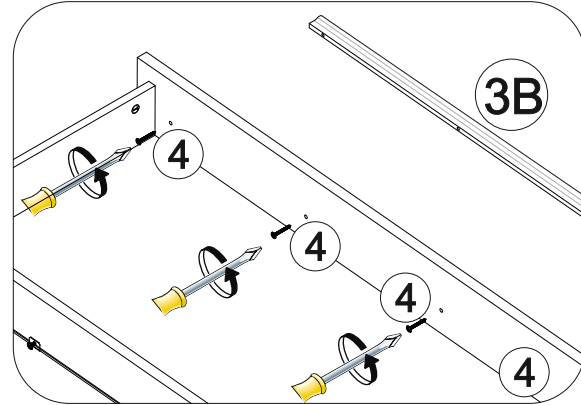
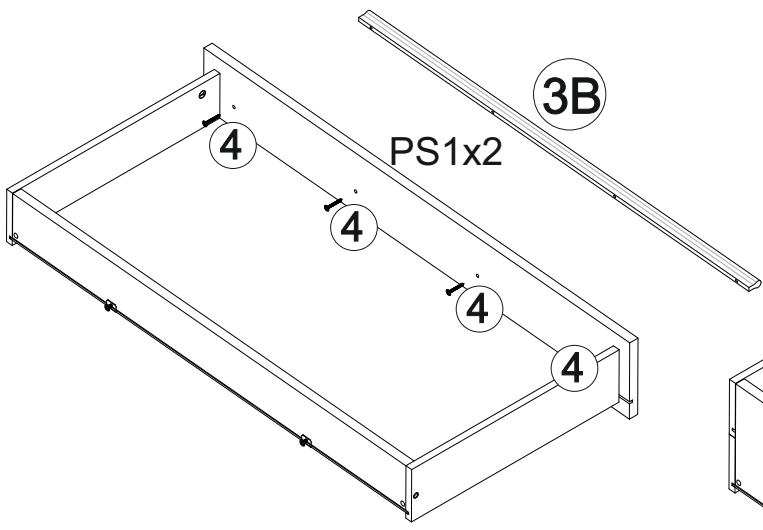
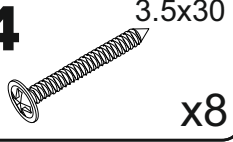

15

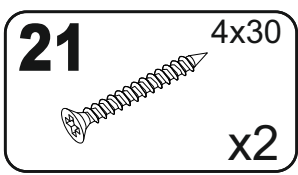

P5 140x896

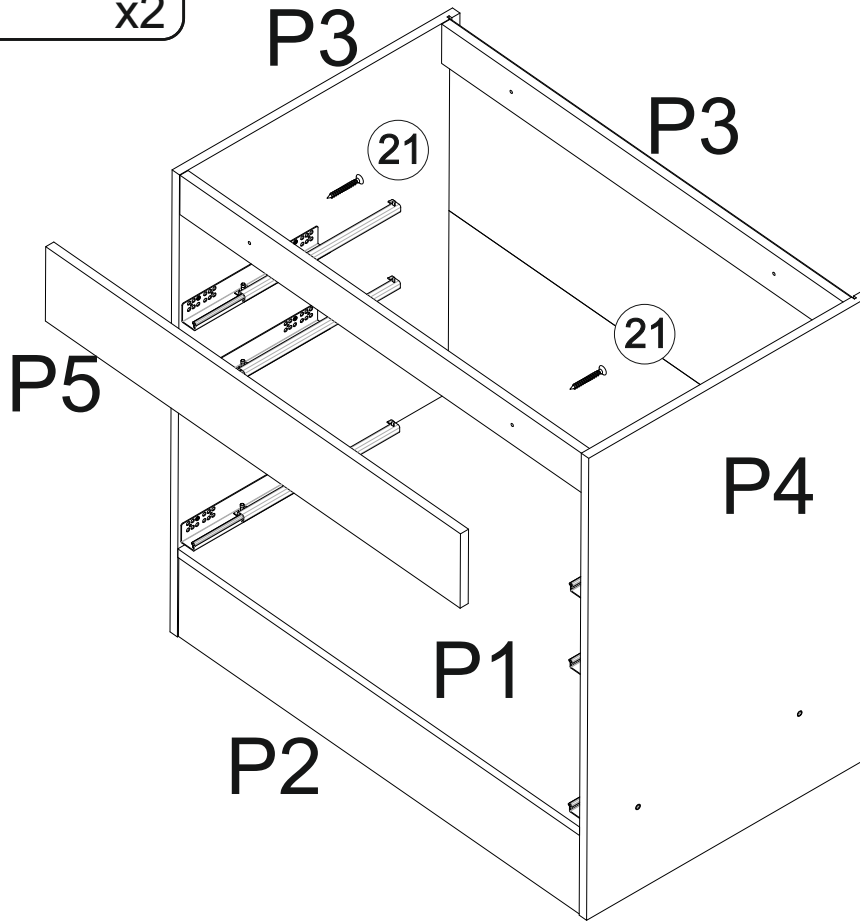

16

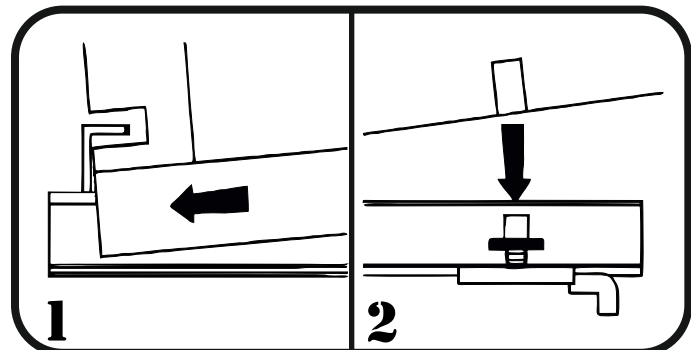
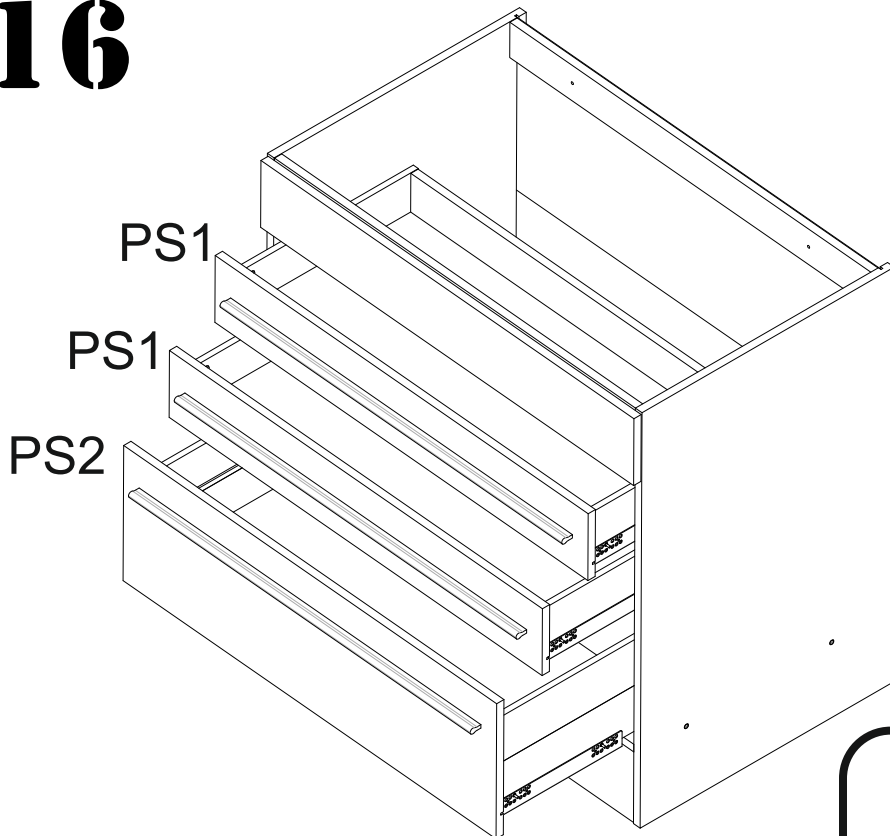

1

J1	600x150
----	---------

J2	713x596
----	---------

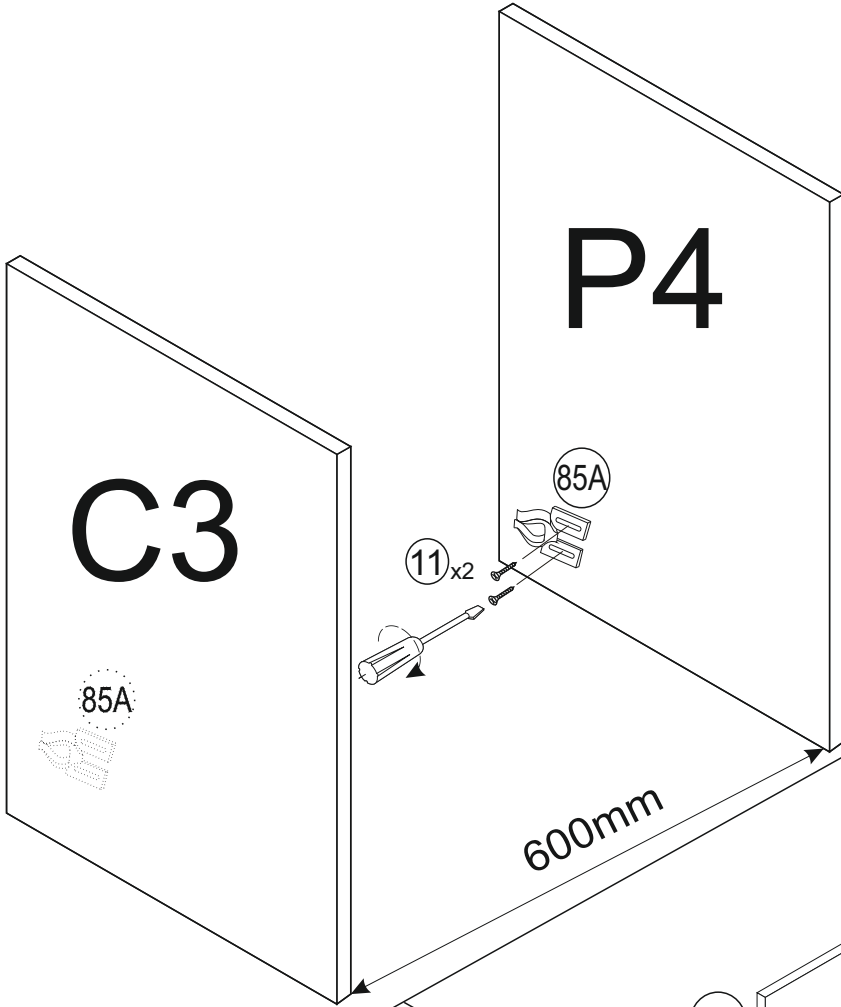
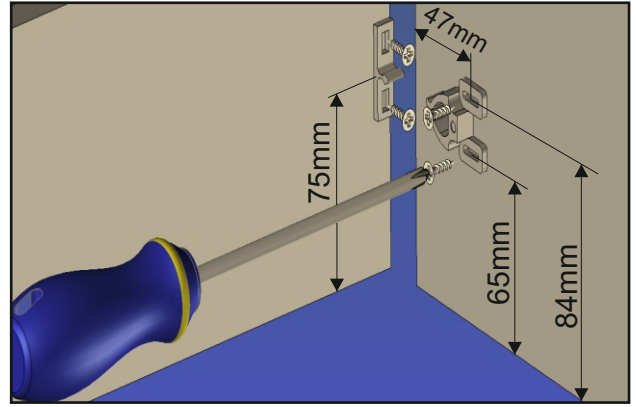

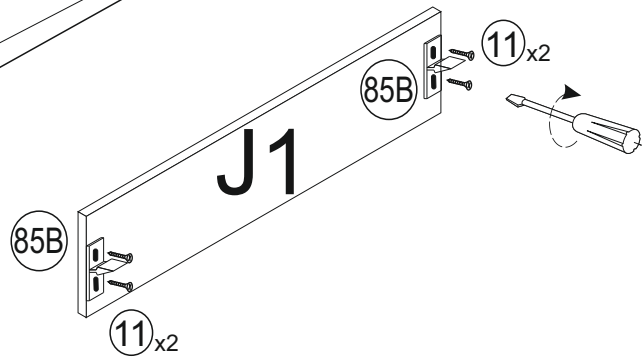

2

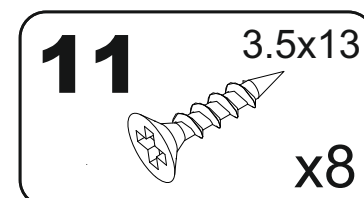
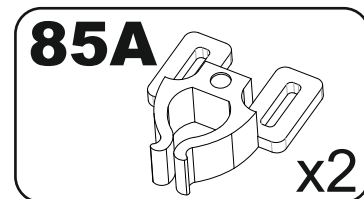
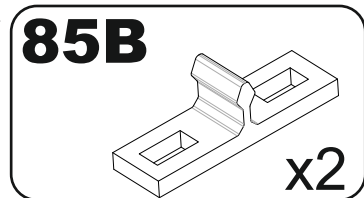
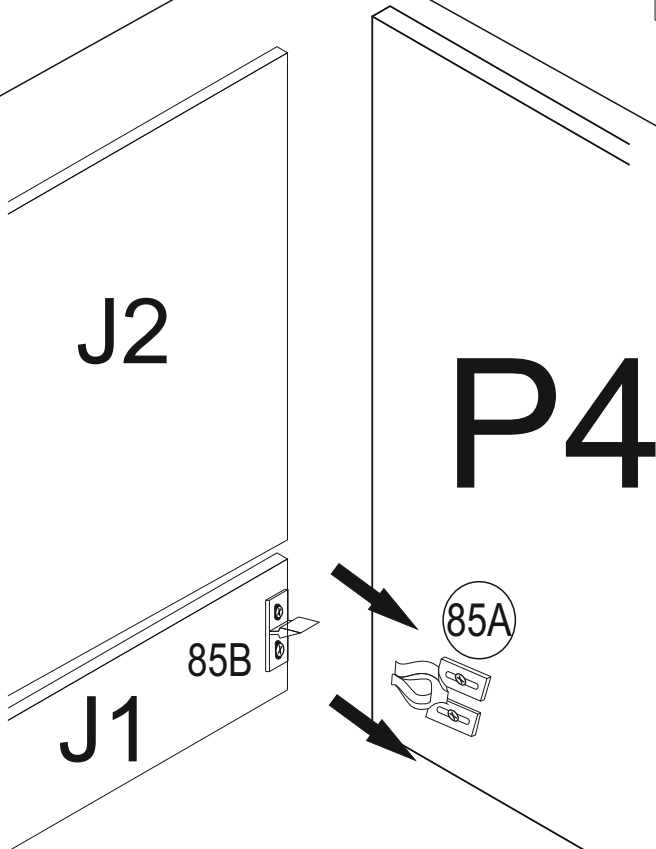

3



41		X 2
4A		X 2
41	