

# Amber

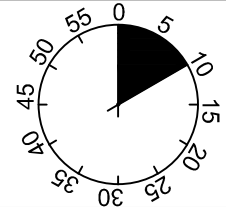

①

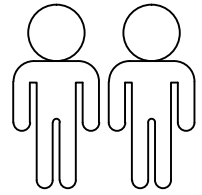
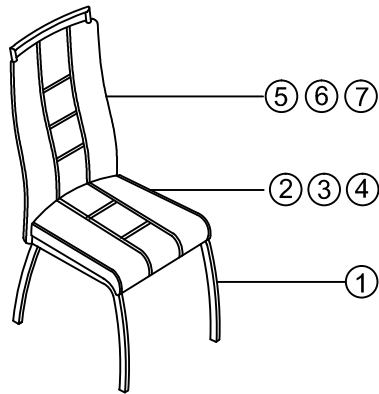
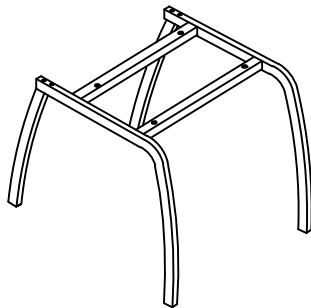

②

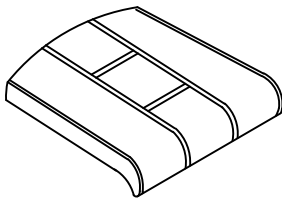

③

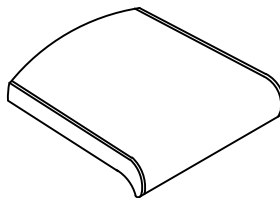

④

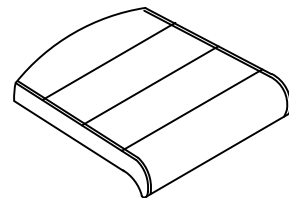

⑤

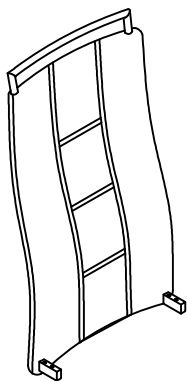





⑥

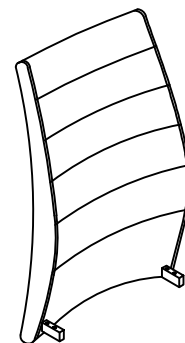

⑦





A	M6X40	B	M6X12	C	Ø18xØ6x1.5	D	4MM
 4x	 4x	 4x	 1x				

I.

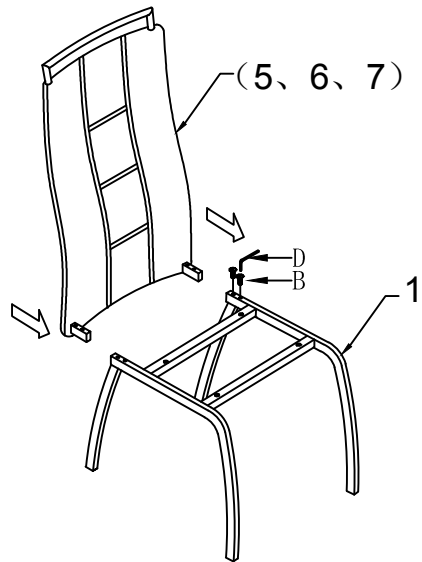



1

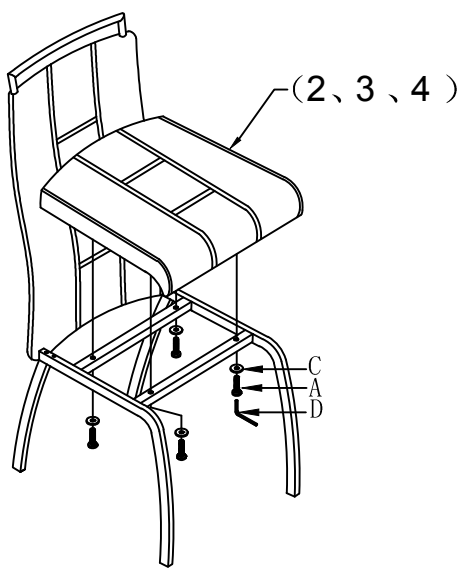

B		M6x12
		4x
D		4MM
		1x
		

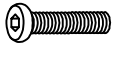
2



A		M6x40
		4x
C		Ø18xØ6x1.5
		4x
D		4MM
		1x
		

3

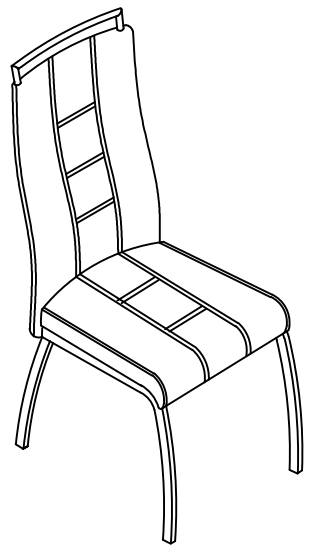

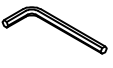
D		4MM
		1x
