

XB(C)EH300
XB(C)NH300
XB(C)FH300
XB(C)WH001

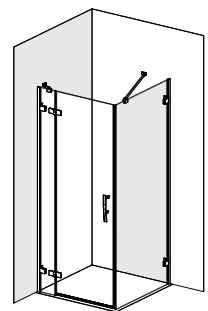

Achtung ! Gläser niemals ungeschützt auf den Boden stellen.
Verletzung der Glaskante führt zu Glasbruch.
Caution ! Never put glass walls on the floor without protection.
Damaging the glass edges results in breaking of the glass.
Attention ! Jamais placer des parois de douche en verre au sol sans
protection. Des verres endommagés casseront.

Aug. 2020 / XC

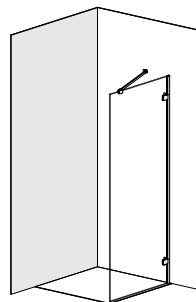
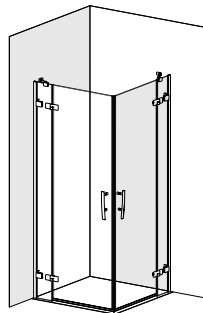
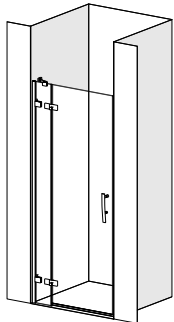
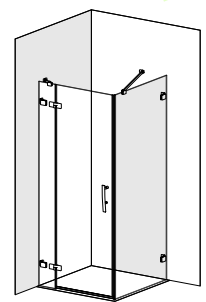
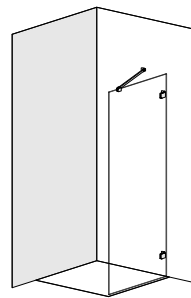
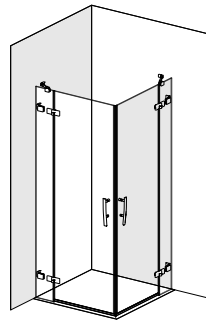
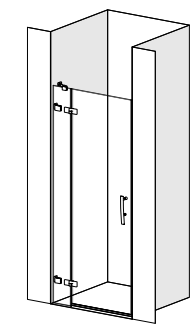

Achtung ! Gläser niemals ungeschützt auf den Boden stellen.
Verletzung der Glaskante führt zu Glasbruch.

Caution ! Never put glass walls on the floor without protection.
Damaging the glass edges results in breaking of the glass.

Attention ! Jamais plaquer des parois de douche en verre au sol sans
protection. Des verres endommagés casseront.



Zum Aufbau benötigen Sie
for mounting you need
pour l'installation il vous faut

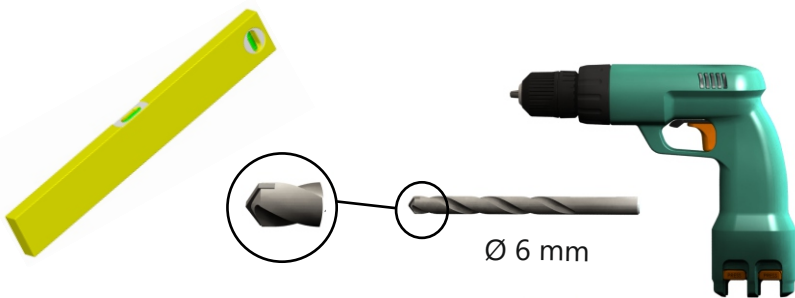
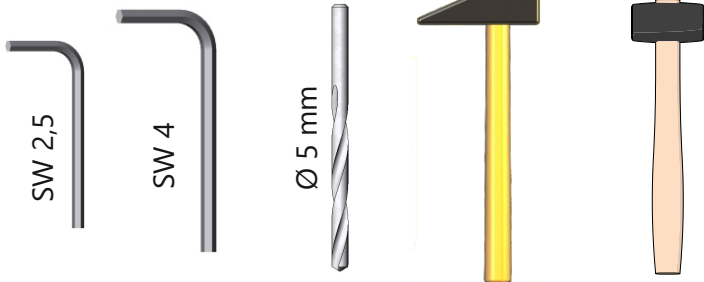

CE

Mitgeliefertes Montagematerial
supplied assembly material
matériaux pour assemblage

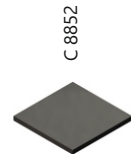

Achtung ! Gläser niemals ungeschützt auf den Boden stellen.
Verletzung der Glaskante führt zu Glasbruch.

Caution ! Never put glass walls on the floor without protection.
Damaging the glass edges results in breaking of the glass.

Attention ! Jamais placer des parois de douche en verre au sol sans protection. Des verres endommagés casseront.



EckEinstieg -- Seite 4-7
corner entry -- page 4-7
entrée d'angle -- page 4-7

XB(C)EH300

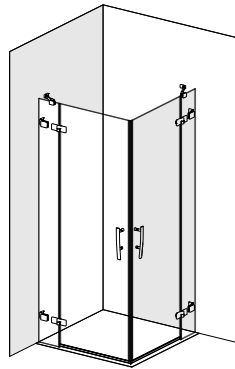

rahmenlos
frameless
sans profil

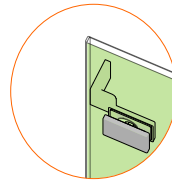

mit Profi
with profile
avec profil

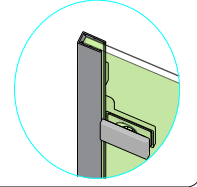

FrontEinstieg -- Seite 4-10
front entry -- page 4-10
entrée avant -- page 4-10

XB(C)FH300

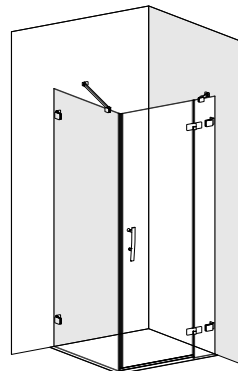
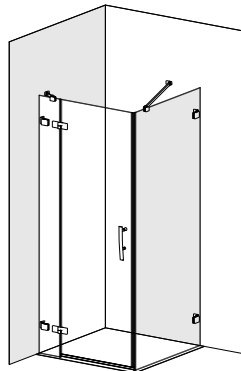

Nische -- Seite 4-7 + 11
niche -- page 4-7 + 11
niche -- page 4-7 + 11

XB(C)NH300

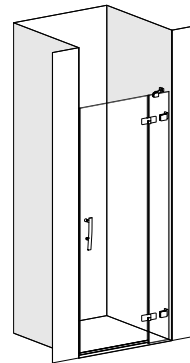
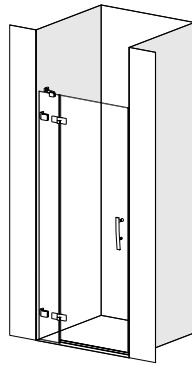

Walk-In -- Seite 8-10
walk-in -- page 8-10
walk-in -- page 8-10

XB(C)WH001

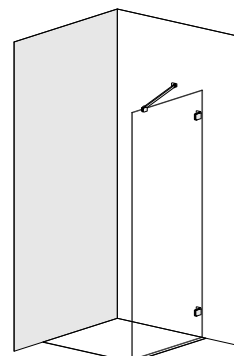
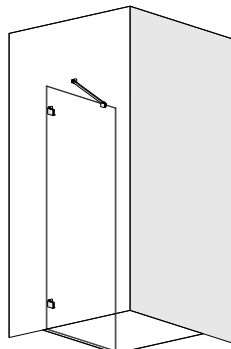

Achtung ! Gläser niemals ungeschützt auf den Boden stellen.
Verletzung der Glaskante führt zu Glasbruch.

Caution ! Never put glass walls on the floor without protection.
Damaging the glass edges results in breaking of the glass.

Attention ! Jamais plaçer des parois de douche en verre au sol sans protection. Des verres endommagés casseront.



Festteil + Tür
fixed part + door
partie fixe + porte

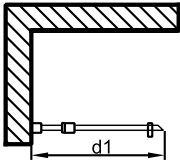

| Modell | Elementmaß element dimension dimension de l'élément d1 (mm) |
|--------|--|
| 800 | 770-772 |
| 900 | 870-872 |
| 1000 | 970-972 |

| Modell | Elementmaß element dimension dimension de l'élément d1 (mm) |
|--------|--|
| 800 | 772-782 |
| 900 | 872-882 |
| 1000 | 972-982 |

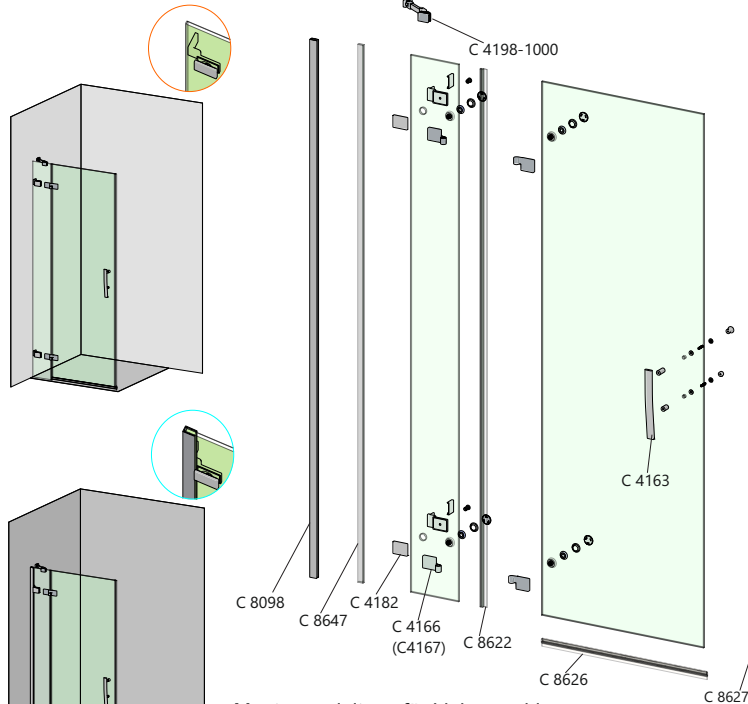

Mittelgeliefertes Montagematerial
supplied assembly material
matériaux pour assemblage

5.0 x 60
2x

D = 6 x 36
2x

C 8852
1x

Montageanleitung für Linksanschlag
(Rechtsanschlag = spiegelbildlich)
Assembly instructions for left hand mounting
(right hand mounting = mirror inverted)
instruction d'assemblage pour charnière à gauche
(à droite = inversé latéralement)

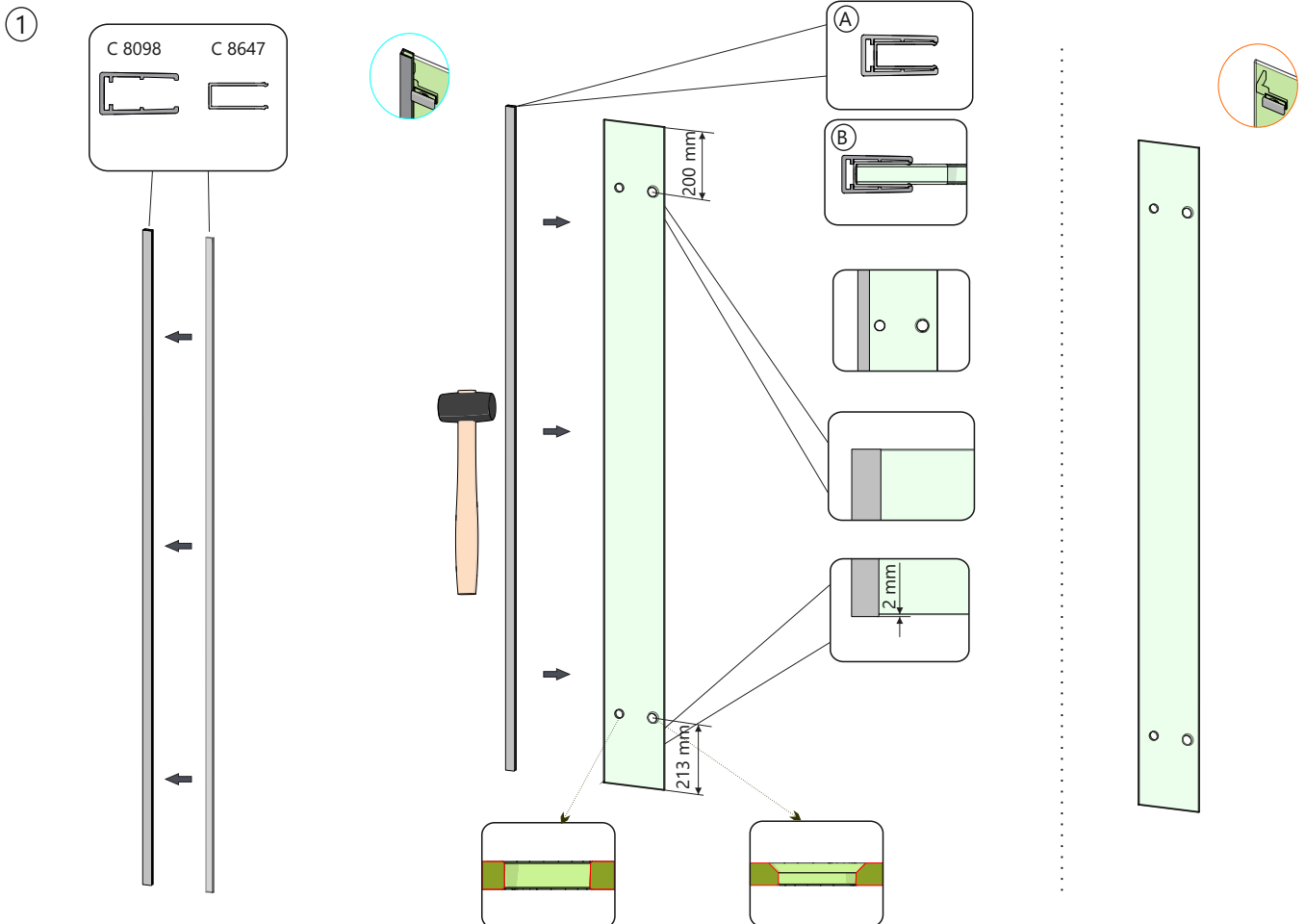

Achtung ! Gläser niemals ungeschützt auf den Boden stellen.
Verletzung der Glaskante führt zu Glasbruch.

Caution ! Never put glass walls on the floor without protection.
Damaging the glass edges results in breaking of the glass.

Attention ! Jamais placer des parois de douche en verre au sol sans protection. Des verres endommagés casseront.

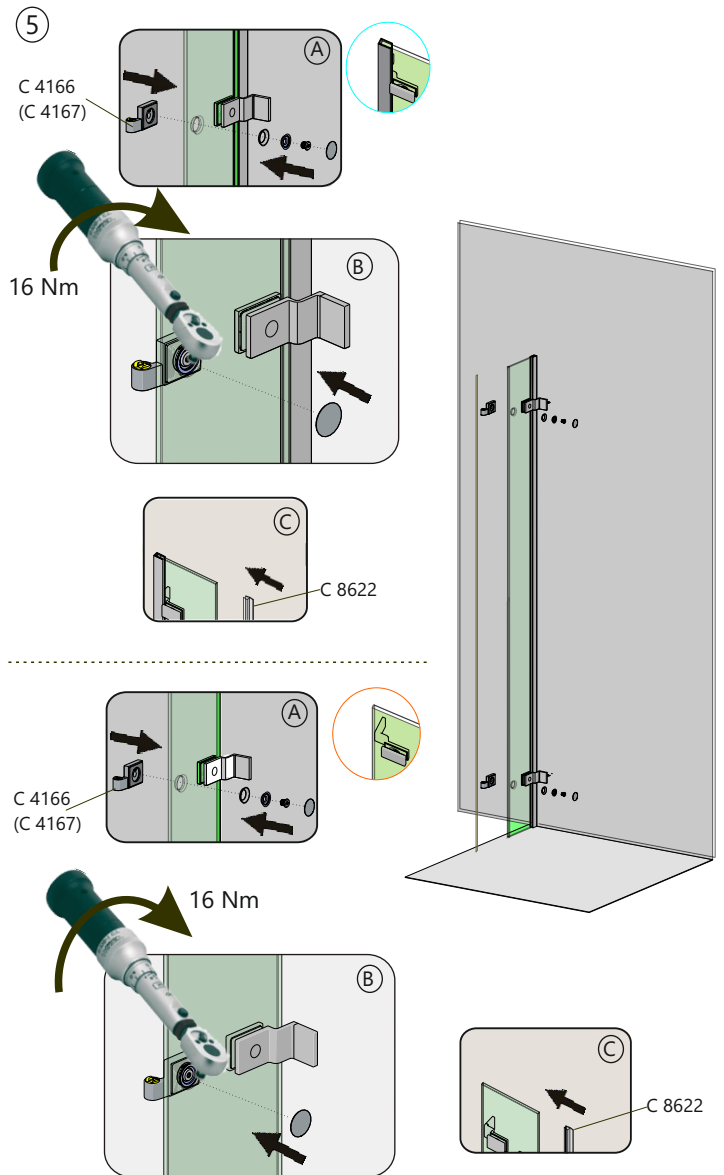
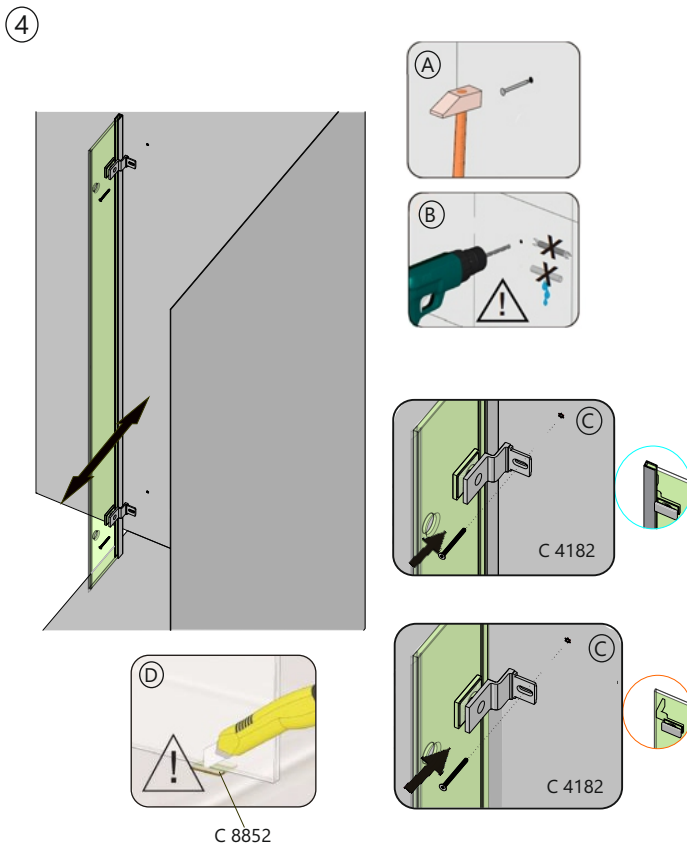
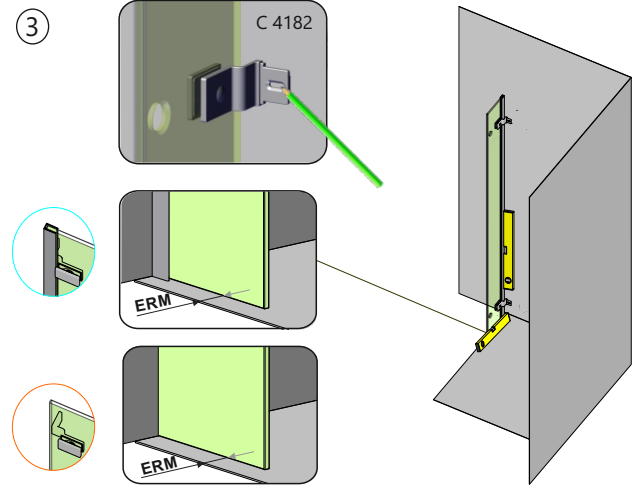
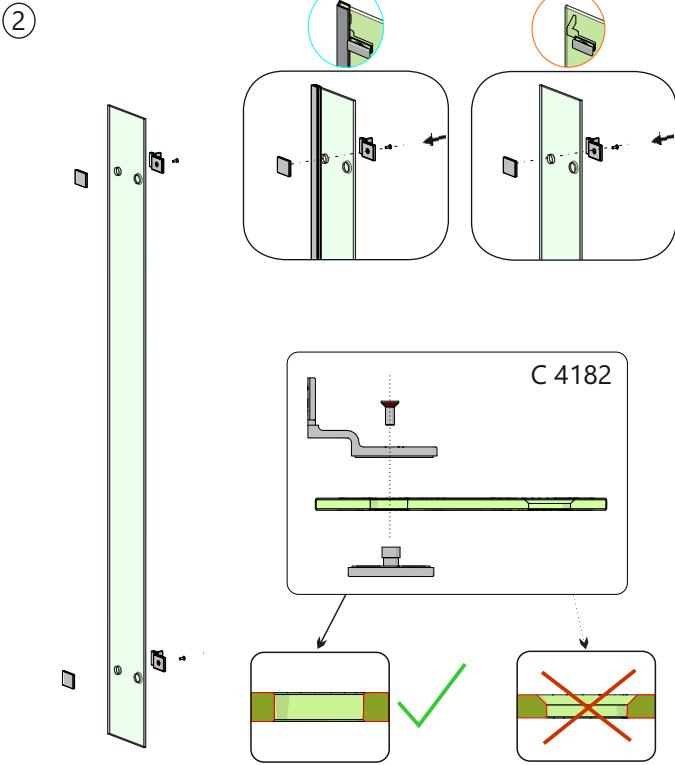

Achtung ! Gläser niemals ungeschützt auf den Boden stellen.
Verletzung der Glaskante führt zu Glasbruch.

Caution ! Never put glass walls on the floor without protection.
Damaging the glass edges results in breaking of the glass.

Attention ! Jamais placer des parois de douche en verre au sol sans protection. Des verres endommagés casseront.

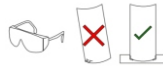

6

! Magnetprofil G8627 nur unten kürzen.
Magnet profile G8627 only shorten at bottom
Profilé magnétique raccourcir au bout au-dessous seulement.

A C 8626

B C 8627

C 45°

D C 8627

E 16 Nm

F C 4166 (C 4167)

7

A Tür / door / porte

B C 8623

C Tür / door / porte

D C 8622

E C8627 + C8627

F C8627 + C8627

8

!

A

B C 4182

C 8098

C

D

5 - 15 mm

Achtung ! Gläser niemals ungeschützt auf den Boden stellen.
Verletzung der Glaskante führt zu Glasbruch.

Caution ! Never put glass walls on the floor without protection.
Damaging the glass edges results in breaking of the glass.

Attention ! Jamais placer des parois de douche en verre au sol sans
protéction. Des verres endommagés casseront.



9

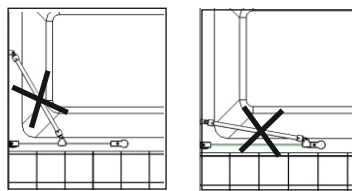
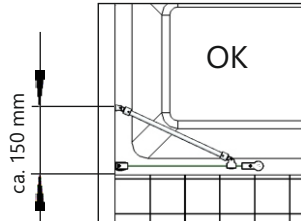
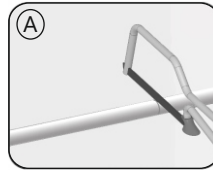
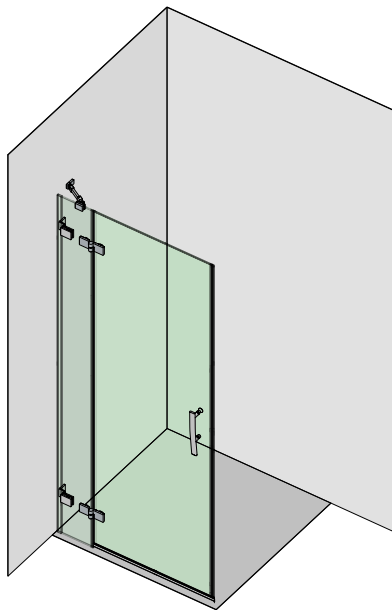

10

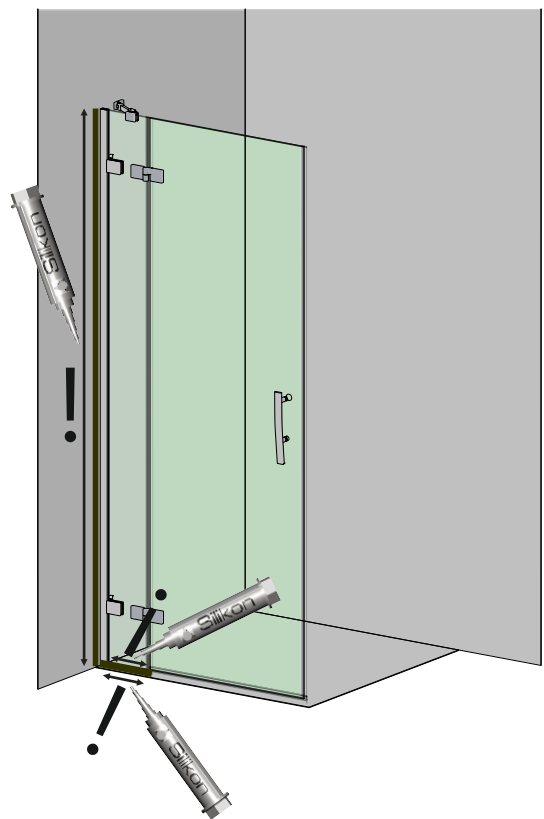
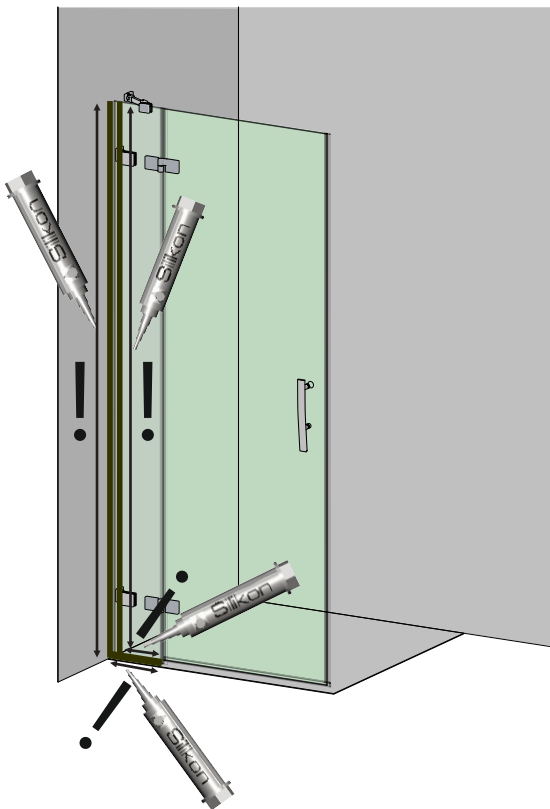
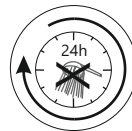

Achtung ! Gläser niemals ungeschützt auf den Boden stellen.
Verletzung der Glaskante führt zu Glasbruch.

Caution ! Never put glass walls on the floor without protection.
Damaging the glass edges results in breaking of the glass.

Attention ! Jamais placer des parois de douche en verre au sol sans protection. Des verres endommagés casseront.



| Seitenteil side panel panneau latéral | |
|---|---|
| | |
| Modell | Elementmaß Maße inkl. Magnetprofil element dimension dimensions incl. magnetic profile dimension de l'élément dimensions avec profil magnétique d1 (mm) |
| 800 | 770-772 |
| 900 | 870-872 |
| 1000 | 970-972 |
| 1200 | 1170-1172 |
| 1400 | 1370-1372 |

| | |
|---------------|---|
| Modell | Elementmaß Maße inkl. Magnetprofil element dimension dimensions incl. magnetic Profile dimension de l'élément dimensions avec profil magnétique d1 (mm) |
| 800 | 772-782 |
| 900 | 872-882 |
| 1000 | 972-982 |
| 1200 | 1172-1182 |
| 1400 | 1372-1382 |

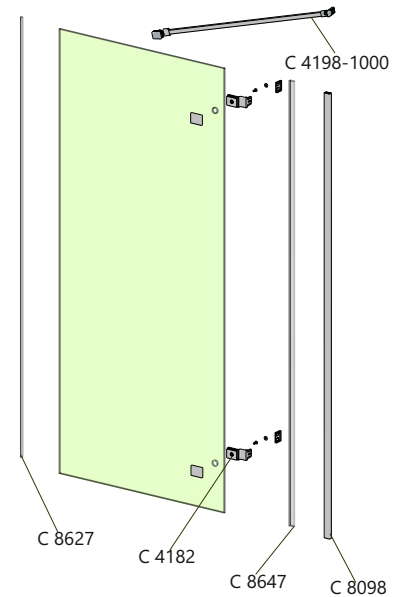
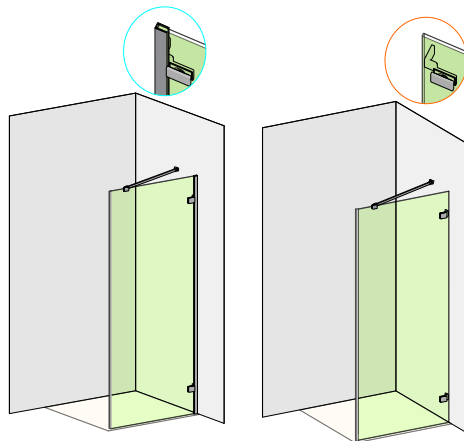

Mitgeliefertes Montagematerial
supplied assembly material
matériaux pour assemblage

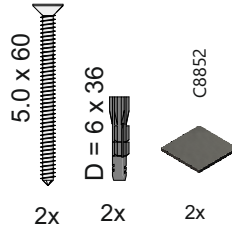

Montageanleitung für Rechtsanschlag
(Linksanschlag = spiegelbildlich)

Assembly instructions for right hand mounting
(left hand mounting = mirror inverted)

instruction d'assemblage pour charnière à droite
(à gauche = inversé latéralement)

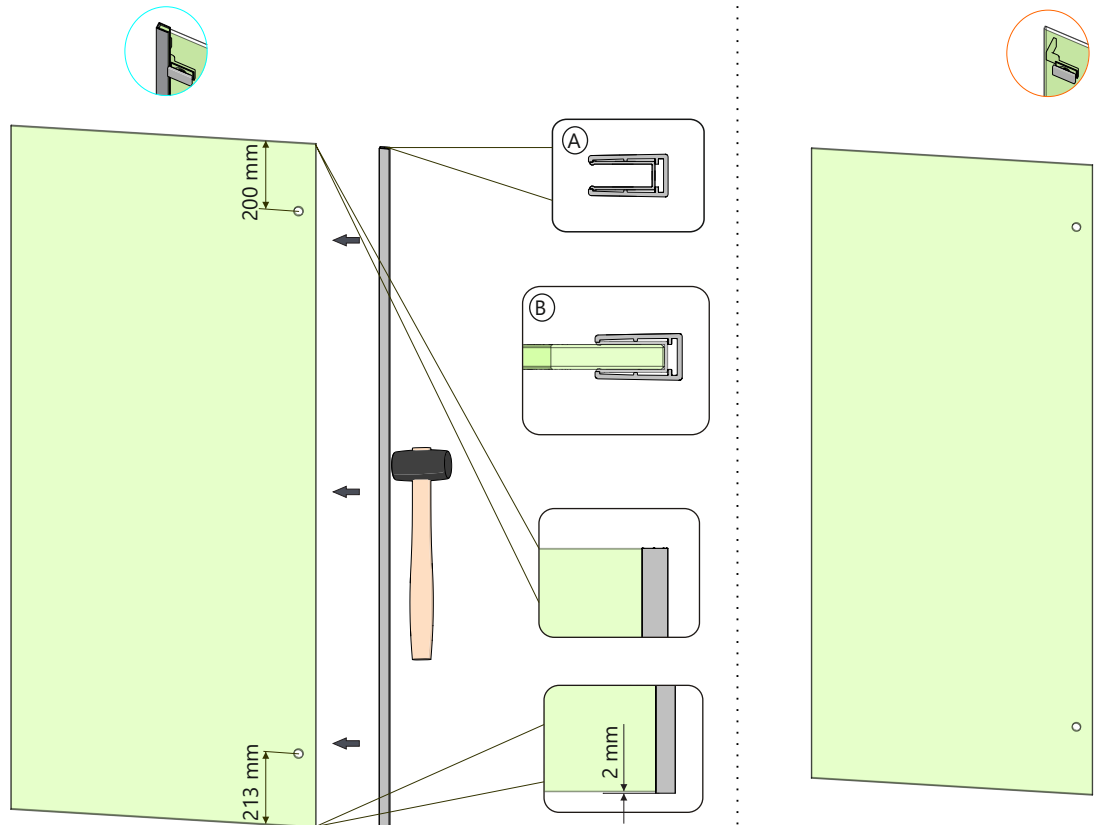
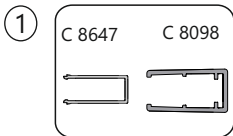

Achtung ! Gläser niemals ungeschützt auf den Boden stellen.
Verletzung der Glaskante führt zu Glasbruch.

Caution ! Never put glass walls on the floor without protection.
Damaging results in breaking of the glass.

Attention ! Jamais plaçer des parois de douche en verre au sol sans
protection. Des verres endommagés casseront.



②

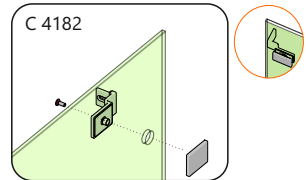
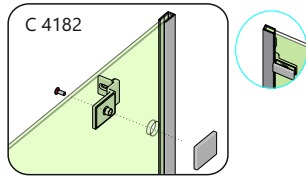
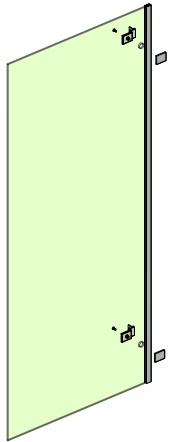

③

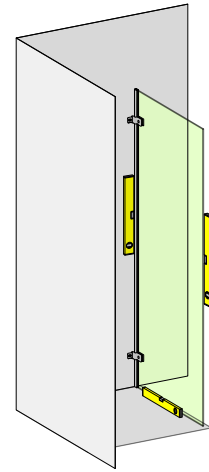
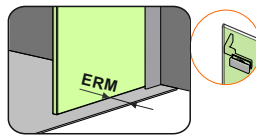
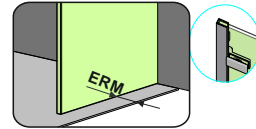
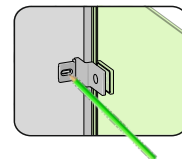

④

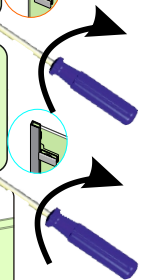
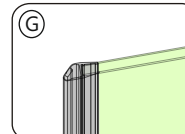
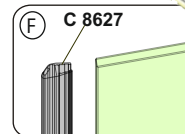
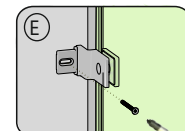
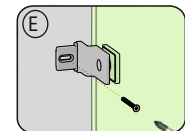
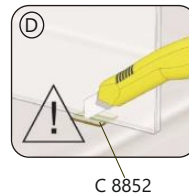
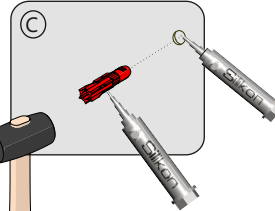
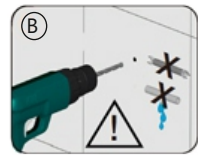
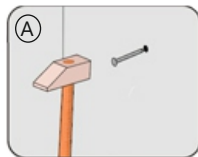
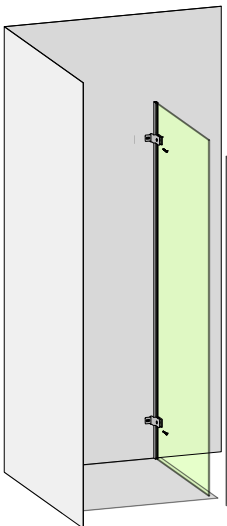

⑤

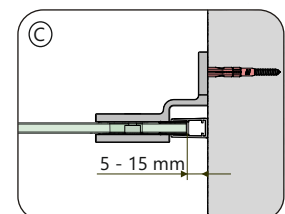
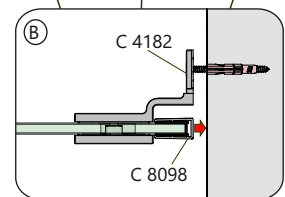
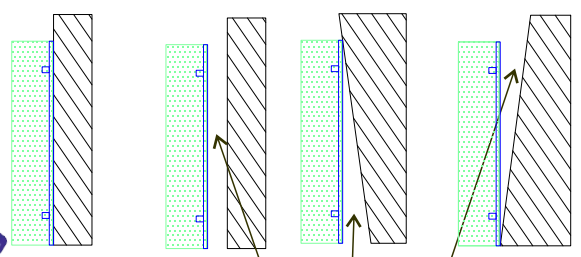
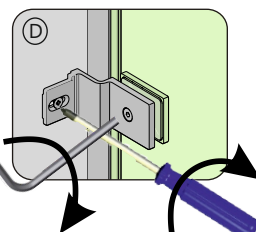
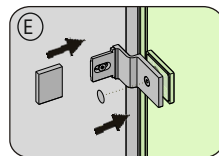
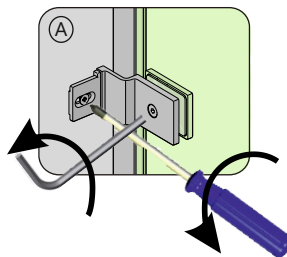
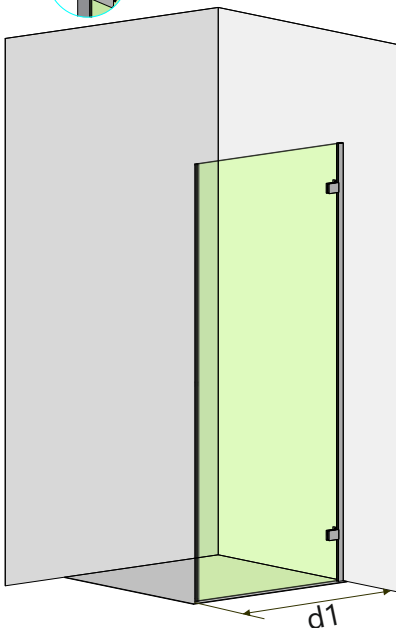

Achtung ! Gläser niemals ungeschützt auf den Boden stellen.
Verletzung der Glaskante führt zu Glasbruch.

Caution ! Never put glass walls on the floor without protection.
Damaging the glass edges results in breaking of the glass.

Attention ! Jamais placer des parois de douche en verre au sol sans protection. Des verres endommagés casseront.



⑥

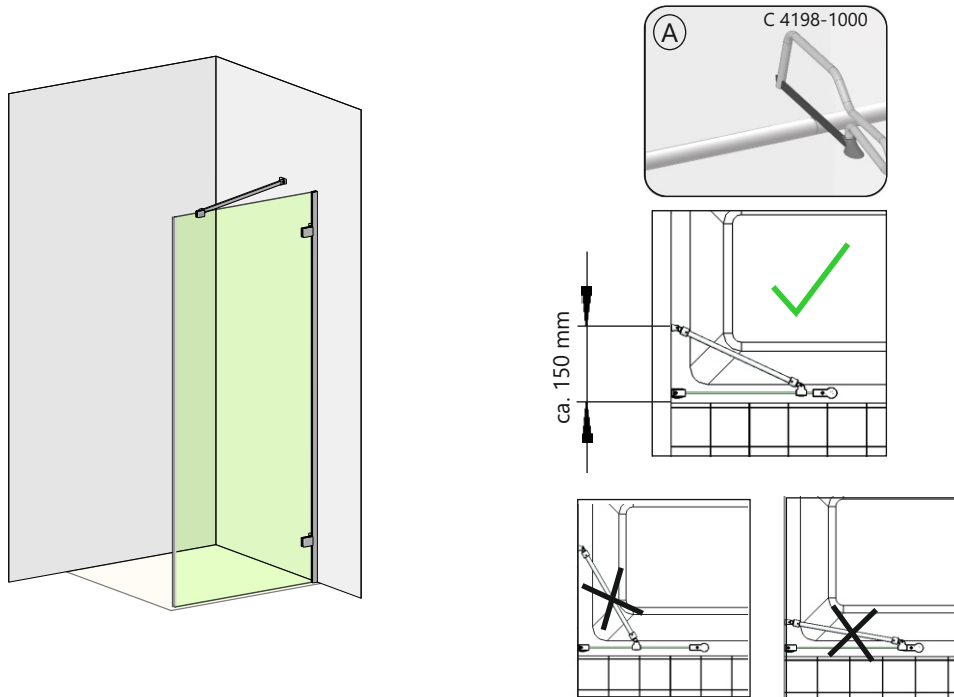

⑦

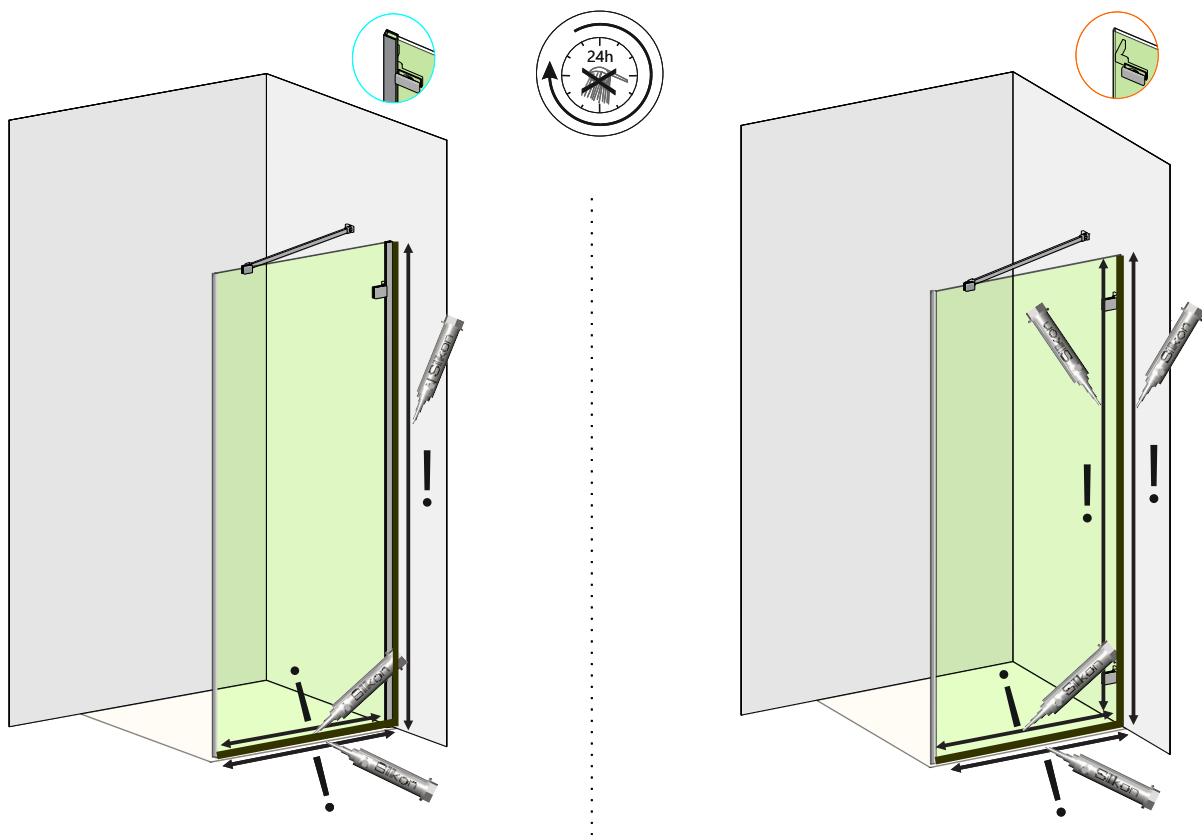

Achtung ! Gläser niemals ungeschützt auf den Boden stellen.
Verletzung der Glaskante führt zu Glasbruch.

Caution ! Never put glass walls on the floor without protection.
Damaging the glass edges results in breaking of the glass.

Attention ! Jamais placer des parois de douche en verre au sol sans protection. Des verres endommagés casseront.

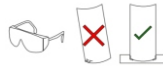

Festteil+Tür
Fixed part + door
Partie fixe + porte

| Modell | Elementmaß element dimension dimension de l'élément d1 (mm) |
|--------|--|
| 800 | 781-791 |
| 900 | 881-891 |
| 1000 | 981-991 |

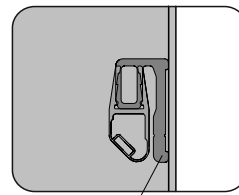
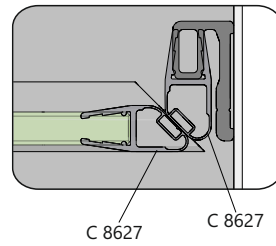
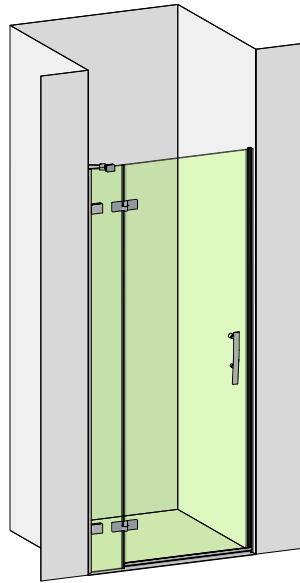

①

Ø 5mm (4x)

A = B C 8050

(A) (B) (C) (D) (E) (F) (G)

②

③

24h

(A)

G8627 + G8627

Achtung ! Gläser niemals ungeschützt auf den Boden stellen.
Verletzung der Glaskante führt zu Glasbruch.

Caution ! Never put glass walls on the floor without protection.
Damaging the glass edges results in breaking of the glass.

Attention ! Jamais placer des parois de douche en verre au sol sans protection. Des verres endommagés casseront.

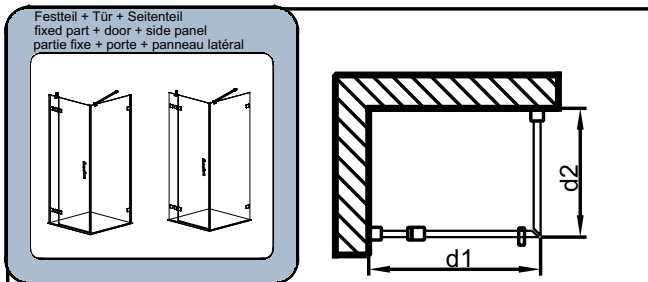

| Modell | Duschasseneinbaumaß shower tray bases installation dimensions receveurs de douche dimension d'installation | Einrückmaß indent dimension dimension de retrait ERM | Elementmaß element dimension dimension de l'élément d1 | Duschasse shower tray receveur de douche |
|--------|--|---|---|--|
| 800 | 785-787 | 15 | 770-772 | 800er 785 bis 802 |
| 800 | 790-792 | 20 | 770-772 | |
| 800 | 795-797 | 25 | 770-772 | |
| 800 | 800-802 | 30 | 770-772 | |
| 900 | 885-887 | 15 | 870-872 | 900er 885 bis 902 |
| 900 | 890-892 | 20 | 870-872 | |
| 900 | 895-897 | 25 | 870-872 | |
| 900 | 900-902 | 30 | 870-872 | |
| 1000 | 985-987 | 15 | 970-972 | 1000er 985 bis 1002 |
| 1000 | 990-992 | 20 | 970-972 | |
| 1000 | 995-997 | 25 | 970-972 | |
| 1000 | 1000-1002 | 30 | 970-972 | |

| Modell | Duschasseneinbaumaß shower tray bases installation dimensions receveurs de douche dimension d'installation | Einrückmaß indent dimension dimension de retrait ERM | Elementmaß element dimension dimension de l'élément d2 | Duschasse shower tray receveur de douche |
|--------|--|---|---|--|
| 800 | 785-787 | 15 | 770-772 | 800er 785 bis 802 |
| 800 | 790-792 | 20 | 770-772 | |
| 800 | 795-797 | 25 | 770-772 | |
| 800 | 800-802 | 30 | 770-772 | |
| 900 | 885-887 | 15 | 870-872 | 900er 885 bis 902 |
| 900 | 890-892 | 20 | 870-872 | |
| 900 | 895-897 | 25 | 870-872 | |
| 900 | 900-902 | 30 | 870-872 | |
| 1000 | 985-987 | 15 | 970-972 | 1000er 985 bis 1002 |
| 1000 | 990-992 | 20 | 970-972 | |
| 1000 | 995-997 | 25 | 970-972 | |
| 1000 | 1000-1002 | 30 | 970-972 | |
| 1200 | 1185-1187 | 15 | 1170-1172 | 1200er 1185 bis 1202 |
| 1200 | 1190-1192 | 20 | 1170-1172 | |
| 1200 | 1195-1197 | 25 | 1170-1172 | |
| 1200 | 1200-1202 | 30 | 1170-1172 | |
| 1400 | 1385-1387 | 15 | 1370-1372 | 1400er 1385 bis 1402 |
| 1400 | 1390-1392 | 20 | 1370-1372 | |
| 1400 | 1395-1397 | 25 | 1370-1372 | |
| 1400 | 1400-1402 | 30 | 1370-1372 | |

| Modell | Duschasseneinbaumaß shower tray bases installation dimensions receveurs de douche dimension d'installation | Einrückmaß indent dimension dimension de retrait ERM | Elementmaß element dimension dimension de l'élément d1 | Duschasse shower tray receveur de douche |
|--------|--|---|---|--|
| 800 | 787-797 | 15 | 772-782 | 800er 787 bis 812 |
| 800 | 792-802 | 20 | 772-782 | |
| 800 | 797-807 | 25 | 772-782 | |
| 800 | 802-812 | 30 | 772-782 | |
| 900 | 887-897 | 15 | 872-882 | 900er 887 bis 912 |
| 900 | 892-902 | 20 | 872-882 | |
| 900 | 897-907 | 25 | 872-882 | |
| 900 | 902-912 | 30 | 872-882 | |
| 1000 | 987-997 | 15 | 972-982 | 1000er 987 bis 1012 |
| 1000 | 992-1002 | 20 | 972-982 | |
| 1000 | 997-1007 | 25 | 972-982 | |
| 1000 | 1002-1012 | 30 | 972-982 | |

| Modell | Duschasseneinbaumaß shower tray bases installation dimensions receveurs de douche dimension d'installation | Einrückmaß indent dimension dimension de retrait ERM | Elementmaß element dimension dimension de l'élément d2 | Duschasse shower tray receveur de douche |
|--------|--|---|---|--|
| 800 | 787-797 | 15 | 772-782 | 800er 787 bis 812 |
| 800 | 792-802 | 20 | 772-782 | |
| 800 | 797-807 | 25 | 772-782 | |
| 800 | 802-812 | 30 | 772-782 | |
| 900 | 887-897 | 15 | 872-882 | 900er 887 bis 912 |
| 900 | 892-902 | 20 | 872-882 | |
| 900 | 897-907 | 25 | 872-882 | |
| 900 | 902-912 | 30 | 872-882 | |
| 1000 | 987-997 | 15 | 972-982 | 1000er 987 bis 1012 |
| 1000 | 992-1002 | 20 | 972-982 | |
| 1000 | 997-1007 | 25 | 972-982 | |
| 1000 | 1002-1012 | 30 | 972-982 | |
| 1200 | 1187-1197 | 15 | 1172-1182 | 1200er 1187 bis 1212 |
| 1200 | 1192-1202 | 20 | 1172-1182 | |
| 1200 | 1197-1207 | 25 | 1172-1182 | |
| 1200 | 1202-1212 | 30 | 1172-1182 | |
| 1400 | 1387-1397 | 15 | 1372-1382 | 1400er 1387 bis 1412 |
| 1400 | 1392-1402 | 20 | 1372-1382 | |
| 1400 | 1397-1407 | 25 | 1372-1382 | |
| 1400 | 1402-1412 | 30 | 1372-1382 | |

Achtung ! Gläser niemals ungeschützt auf den Boden stellen.
Verletzung der Glaskante führt zu Glasbruch.

Caution ! Never put glass walls on the floor without protection.
Damaging the glass edges results in breaking of the glass.

Attention ! Jamais placer des parois de douche en verre au sol sans protection. Des verres endommagés casseront.

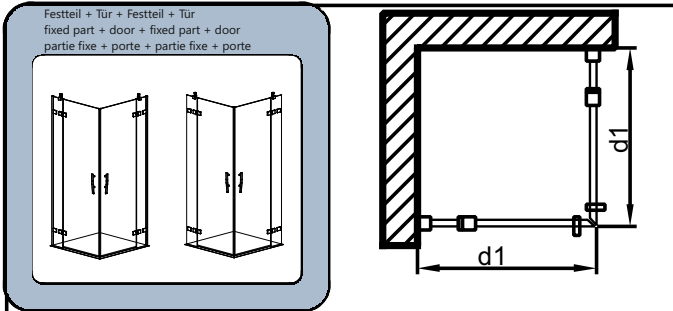

| Modell | Duschtassenbaumaß shower tray bases installation dimensions receveurs de douche dimension d'installation | Einrückmaß indent dimension dimension de retrait ERM | Elementmaß élément dimension dimension de l'élément d1 | Duschtasse shower tray receveur de douche |
|--------|--|---|---|---|
| 800 | 785-787 | 15 | 770-772 | 800er 785 bis 802 |
| 800 | 790-792 | 20 | 770-772 | |
| 800 | 795-797 | 25 | 770-772 | |
| 800 | 800-802 | 30 | 770-772 | |
| 900 | 885-887 | 15 | 870-872 | 900er 885 bis 902 |
| 900 | 890-892 | 20 | 870-872 | |
| 900 | 895-897 | 25 | 870-872 | |
| 900 | 900-902 | 30 | 870-872 | |
| 1000 | 985-987 | 15 | 970-972 | 1000er 985 bis 1002 |
| 1000 | 990-992 | 20 | 970-972 | |
| 1000 | 995-997 | 25 | 970-972 | |
| 1000 | 1000-1002 | 30 | 970-972 | |

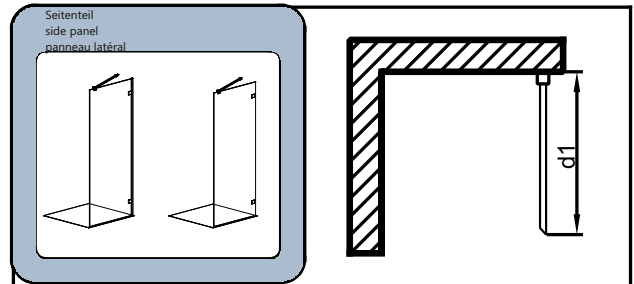

| Modell | Elementmaß Maße ohne Magnetprofil élément dimension dimension without magnetic profile dimension de l'élément dimension sans profil magnétique d1 | Modell | Elementmaß Maße ohne Magnetprofil élément dimension dimension without magnetic profile dimension de l'élément dimension sans profil magnétique d1 |
|--------|---|--------|---|
| 800 | 754-756 | 800 | 756-766 |
| 900 | 854-856 | 900 | 856-866 |
| 1000 | 954-956 | 1000 | 956-966 |
| 1200 | 1154-1156 | 1200 | 1156-1166 |
| 1400 | 1354-1356 | 1400 | 1356-1366 |

| Modell | Duschtassenbaumaß shower tray bases installation dimensions receveurs de douche dimension d'installation | Einrückmaß indent dimension dimension de retrait ERM | Elementmaß élément dimension dimension de l'élément d1 | Duschtasse shower tray receveur de douche |
|--------|--|---|---|---|
| 800 | 787-797 | 15 | 772-782 | 800er 787 bis 812 |
| 800 | 792-802 | 20 | 772-782 | |
| 800 | 797-807 | 25 | 772-782 | |
| 800 | 802-812 | 30 | 772-782 | |
| 900 | 887-897 | 15 | 872-882 | 900er 887 bis 912 |
| 900 | 892-902 | 20 | 872-882 | |
| 900 | 897-907 | 25 | 872-882 | |
| 900 | 902-912 | 30 | 872-882 | |
| 1000 | 987-997 | 15 | 972-982 | 1000er 987 bis 1012 |
| 1000 | 992-1002 | 20 | 972-982 | |
| 1000 | 997-1007 | 25 | 972-982 | |
| 1000 | 1002-1012 | 30 | 972-982 | |

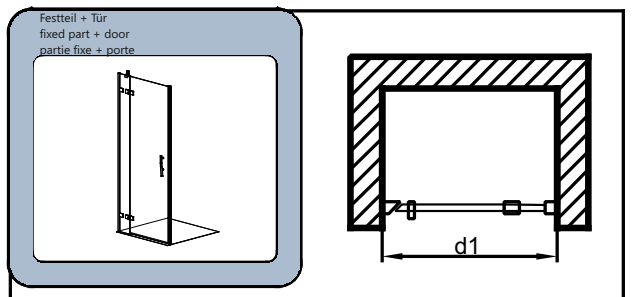

| Modell | Elementmaß élément dimension dimension de l'élément d1 |
|--------|---|
| 800 | 781-791 |
| 900 | 881-891 |
| 1000 | 981-991 |

EG-Konformitätserklärung
EC Declaration of Conformity

Hersteller/ Name und Adresse: GEO Produkte GmbH
Manufacturer/ name and address: Friedrichsfelder Straße 27
68723 Schwetzingen

Wir erklären in alleiniger Verantwortung:
We declare under our sole responsibility:

Produktbenennung: Duschabtrennung mit ESG
oder Kunststoffglas
product designation: shower enclosure with
tempered glass and acrylic-glass

Typ / Modell: alle Modelle
type / model: all models

stehen in Übereinstimmung mit den Bestimmungen der im Folgenden
genannten Richtlinie und Standards:
*are in conformity with the provisions of the following regulations and
standards:*

EN 14428:2004 + A1:2008



GEO Produkte GmbH
Friedrichsfelder Straße 27
68723 Schwetzingen /Germany
Tel. +49(0)6202 20930
FAX +49(0)6202 209399

13

DE2013/01

www.geoprodukte.com/service/leistungserklärung.html/

EN 14428

Duschabtrennung mit Einscheiben Sicherheitsglas oder Kunststoffglas
Shower wall made of *ESG tempered safety glass or sythetic glass*

Reinigbarkeit:
cleanability: Bestanden
passed

Bruch Eigenschaften:
impact resistance: Bestanden
passed

Dauerhaftigkeit:
durability: Bestanden
passed