

LeuchtenDirekt

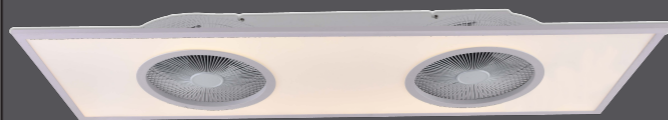

LeuchtenDirekt

LeuchtenDirekt GmbH

Olakenweg 36 · D-59457 Werl

+49(0)2922 9721 9290

Kundenservice@neuhaus-group.de

www.leuchtdirekt.de

997592 - FLAT-AIR

DE
GB
FR
BG
CZ
DK
EL
ES
ET
FI
HR
HU
IT
LT
LV
NL
NO
PL
PT
RO
RU
SK
SL
SR
SV
TR

- DE** Dieses Produkt enthält eine Lichtquelle der Energieeffizienzklasse <E>.
- GB** This product contains a light source of energy efficiency class <E>.
- FR** Ce produit comprend une source de lumière de classe d'efficacité énergétique <E>.
- BG** Продуктът съдържа източник на светлина с клас на енергийна ефективност <E>.
- CZ** Tento výrobek obsahuje světelný zdroj třídy energetické účinnosti <E>.
- DK** Dette produkt indeholder en lyskilde af energieeffektklasse <E>.
- EL** Αυτό το προϊόν περιέχει πηγή φωτός της τάξης ενεργειακής απόδοσης <E>.
- ES** Este producto contiene una fuente de luz de la clase de eficiencia energética <E>.
- ET** See toode sisaldab valgusallikat energiatõhusklassiga <E>.
- FI** Tämä tuote sisältää energiatehokkuusluokan <E> valonlähteen.
- HR** Ovaj proizvod sadrži izvor svjetlosti energetskog razreda <E>.
- HU** Ez a termék <E> energiahatákonysági osztályba tartozó fényforrást tartalmaz.
- IT** Questo prodotto contiene una sorgente luminosa della classe di efficienza energetica <E>.
- LT** Šis produktas yra su šviesos šaltiniu, kurio energinio efektyvumo klasė yra <E>.
- LV** Šis izstrādājums satur gaismas avotu, kas atbilst energoefektivitātes klasei <E>.
- NL** Dit product bevat een lichtbron van energie-efficiëntieklasse <E>.
- NO** Dette produktet inneholder en lyskilde i energieffektivitetsklasse <E>.
- PL** Produkt ten zawiera źródło światła o klasie efektywności energetycznej <E>.
- PT** Este produto contém uma fonte de luz da classe de eficiência energética <E>.
- RO** Acest produs conține o sursă de lumină din clasa de eficiență energetică <E>.
- RU** Данное изделие содержит источник света класса энергоэффективности <E>.
- SK** Tento výrobok obsahuje zdroj svetla triedy energetickej efektivity <E>.
- SL** Ta izdelek vsebuje svetlobni vir razreda energijske učinkovitosti <E>.
- SR** Ovaj proizvod sadrži izvor svetlosti energetske klase <E>.
- SV** Denna produkt innehåller en ljuskälla i energieffektivitetsklass <E>.
- TR** Bu ürün, enerji verimliliği sınıfına sahip bir ışık kaynağı içerir <E>.

LED 24 W
3.100 lm
28 W
1.900 lm
t 25.000 h
T_K 2.700 - 5.000 K
15.000 x
< 0,5 s

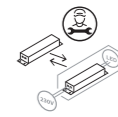

997592	
	230V / 50Hz~
LED	1x LED-Board 24V DC/24 W
	2x FAN 24V DC/15 W
	1x 2x 1,5V, AAA 4x 4x

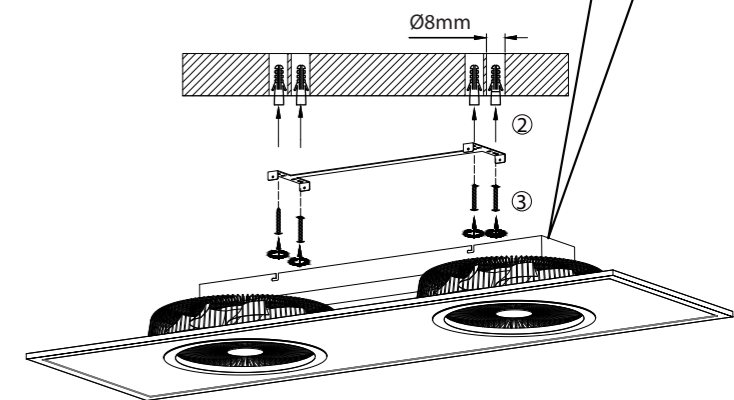
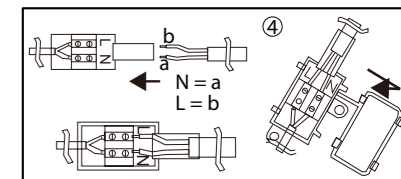
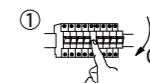

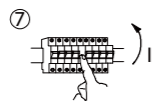
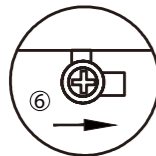
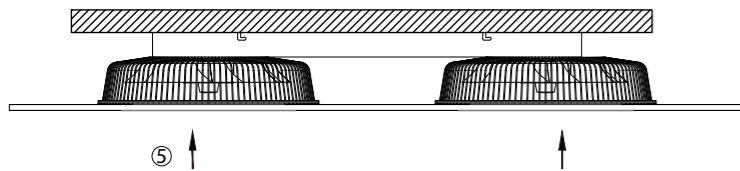

Aus (nach 15 min ohne Bedienung) / off (after 15 min without any operation)

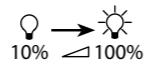

10% → 100%

5.000K → 2.700K

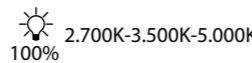

100% → 20%

2.700K-3.500K-5.000K

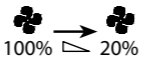

100% → 20%



1 / 0

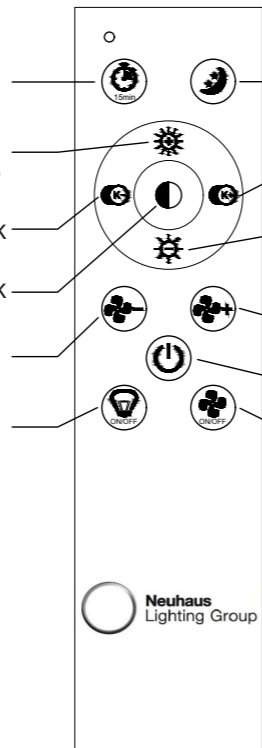

10% 2700K

2.700K → 5.000K

100% → 10%

20% → 100%

aus/off

1 / 0

Bedienungshinweise:

Sollte Ihre Leuchte nicht an die mitgelieferte Fernbedienung angelern sein, lernen Sie die Fernbedienung wie folgt an die Leuchte an:

Schalten Sie die Leuchte über den Wandschalter ein. Drücken Sie die

Taste  innerhalb von 6 Sekunden und halten Sie diese für 2 Sekunden gedrückt. Wenn die Leuchte 3x aufblinkt, war das Anlernen erfolgreich. Blinkt die Leuchte nicht auf, warten Sie 10 Sekunden und wiederholen Sie den oben genannten Vorgang. Sobald das Anlernen erfolgreich war, ist das Bedienen der Leuchte nur noch mit dieser Fernbedienung möglich.

Instructions for use:

If your light is not assigned to the enclosed remote control, assign the remote control to the light as follows:

Turn the light on using the wall switch. Press the button  within 6 seconds and hold it down for 2 seconds. If the light flicker 3 times, the teaching was successful.

If the light does not flicker, turn off the light for 10 seconds and repeat the above process. After the light has been assigned, the light can only be operated with this remote control.

