

Pavilion 16.5 m<sup>2</sup>

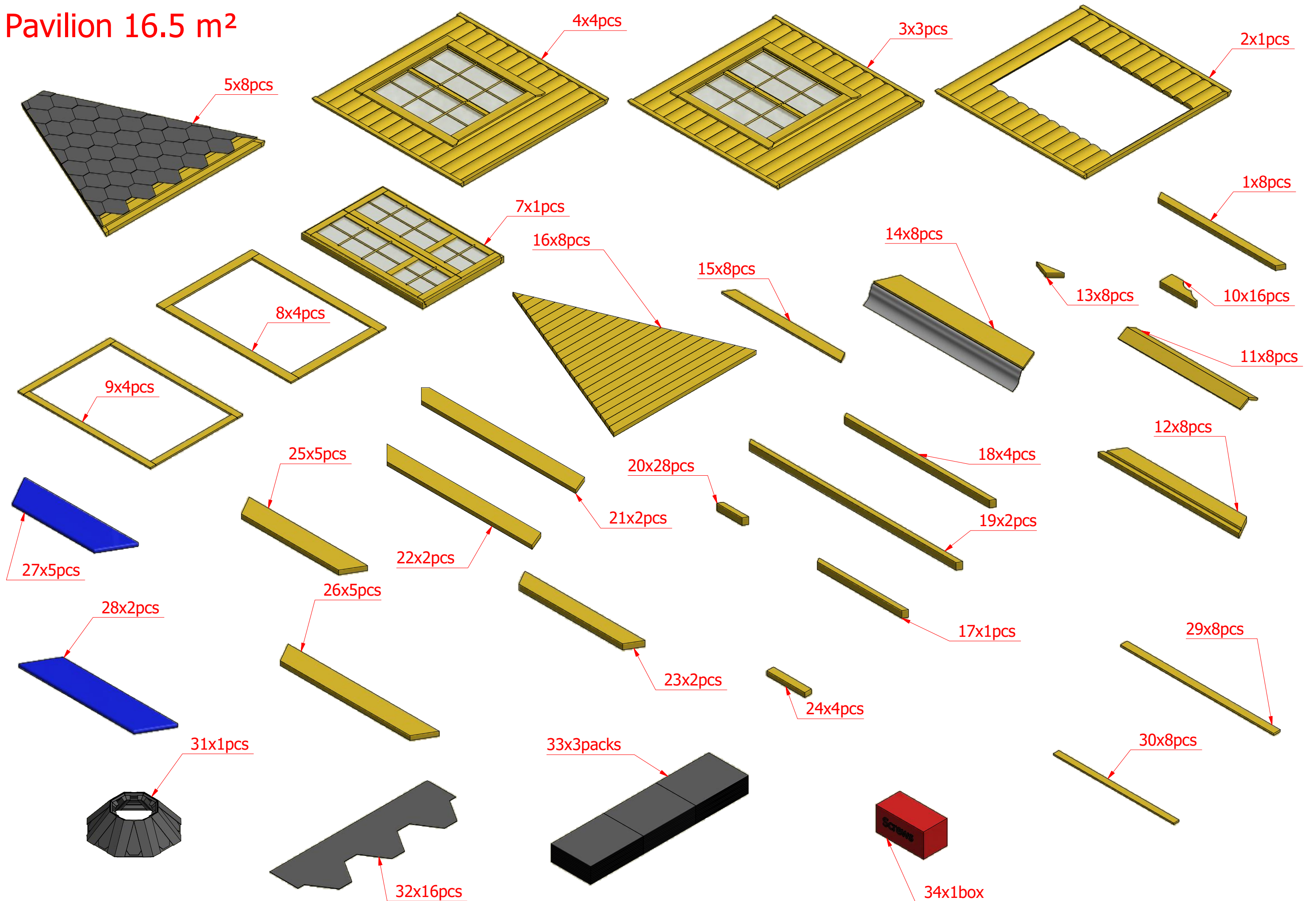

# Pavilion 16.5 m<sup>2</sup>



Pavilion 16.5 m<sup>2</sup>

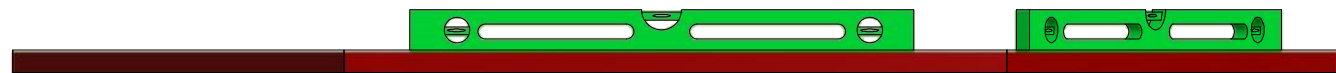
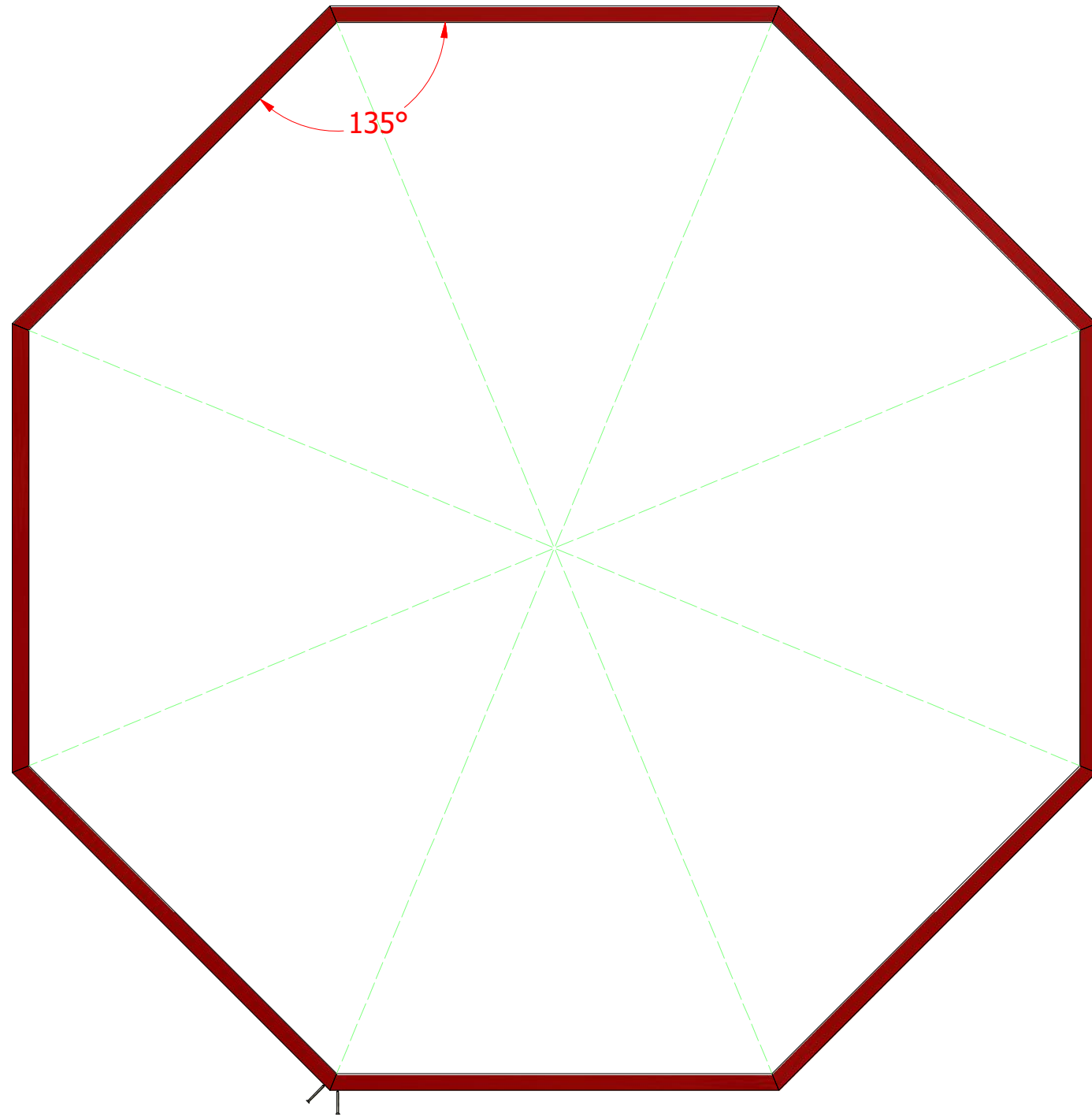

### Screws

1	S1	5x100	16 pcs

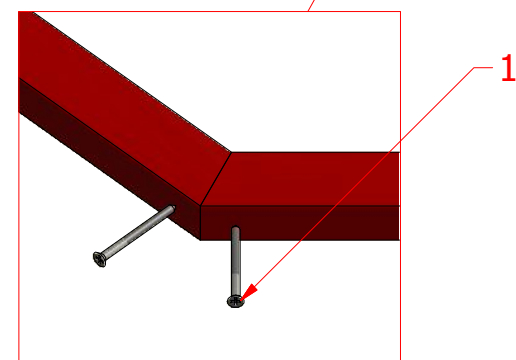
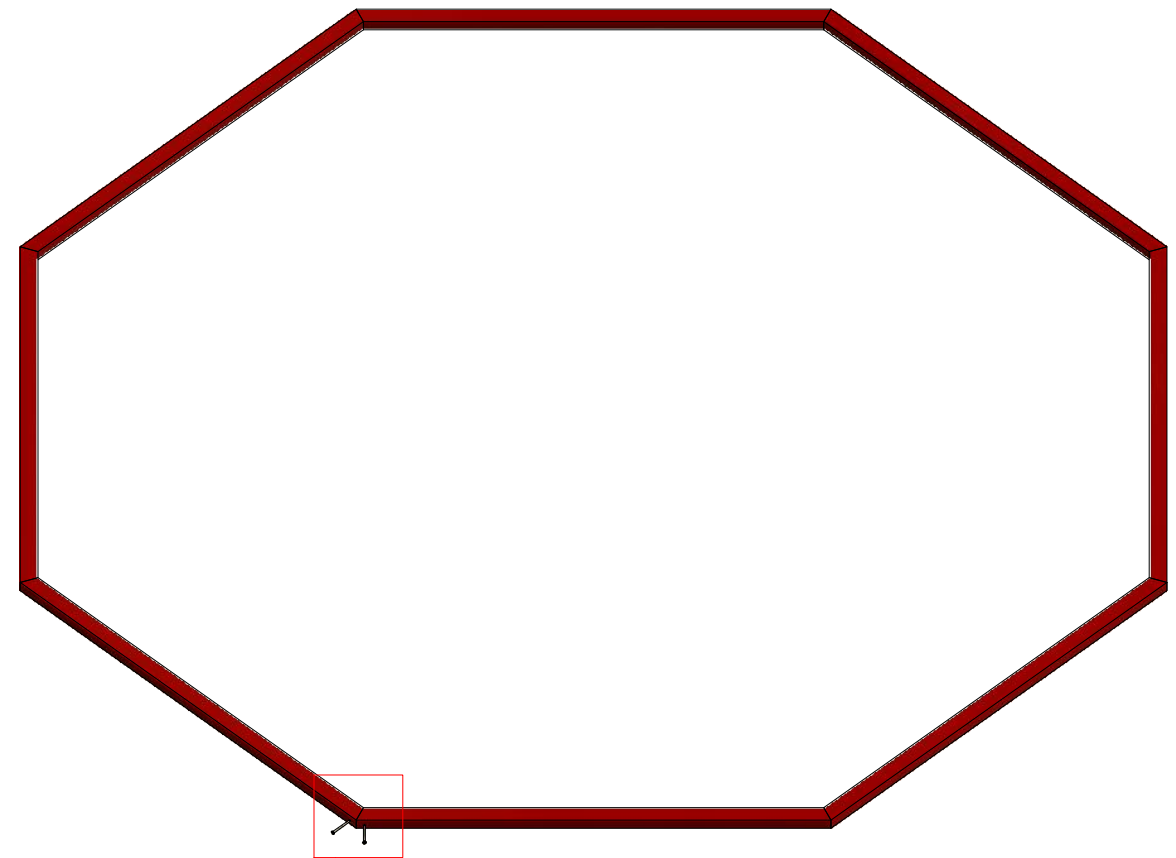

1



# Pavilion 16.2 m<sup>2</sup>

## Screws

1	S2	4x70	48 pcs

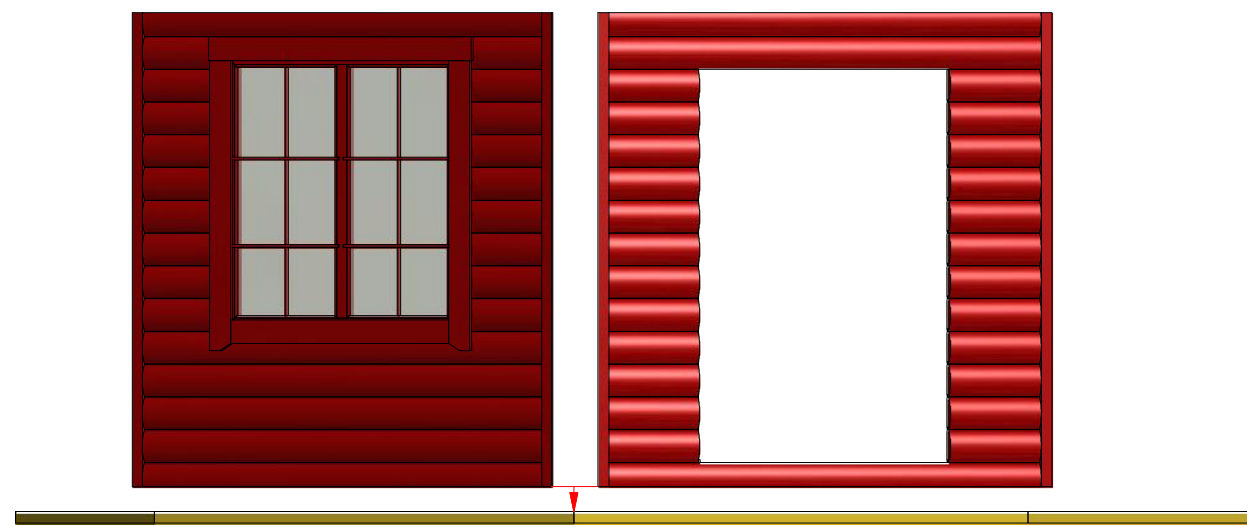
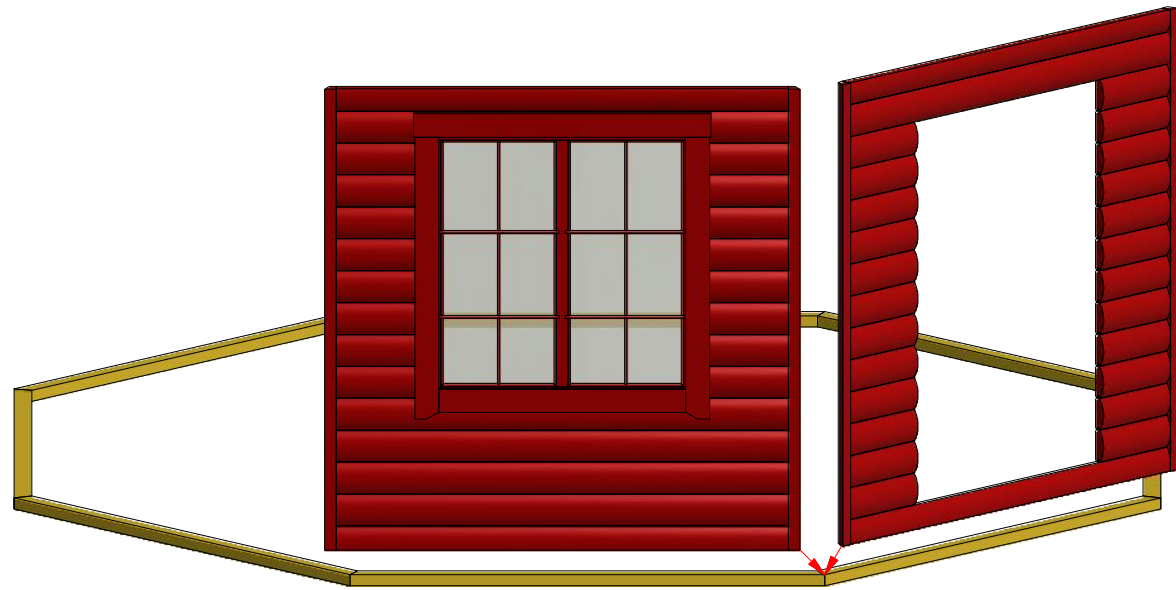

2.1

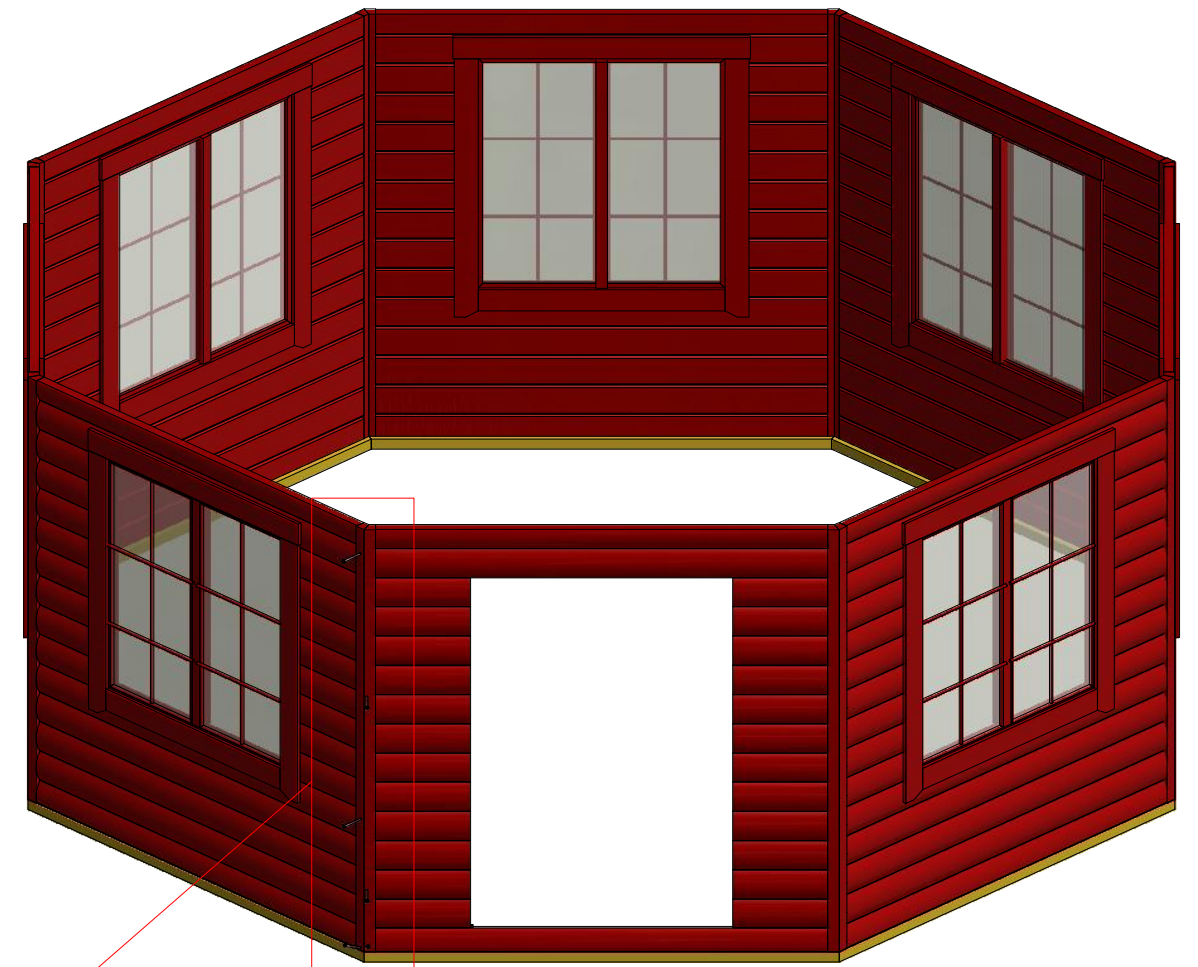

2.2

# Pavilion 16.5 m<sup>2</sup>

## Screws

1	S2	4x70	32 pcs
2	S3	3.5x45	48 pcs

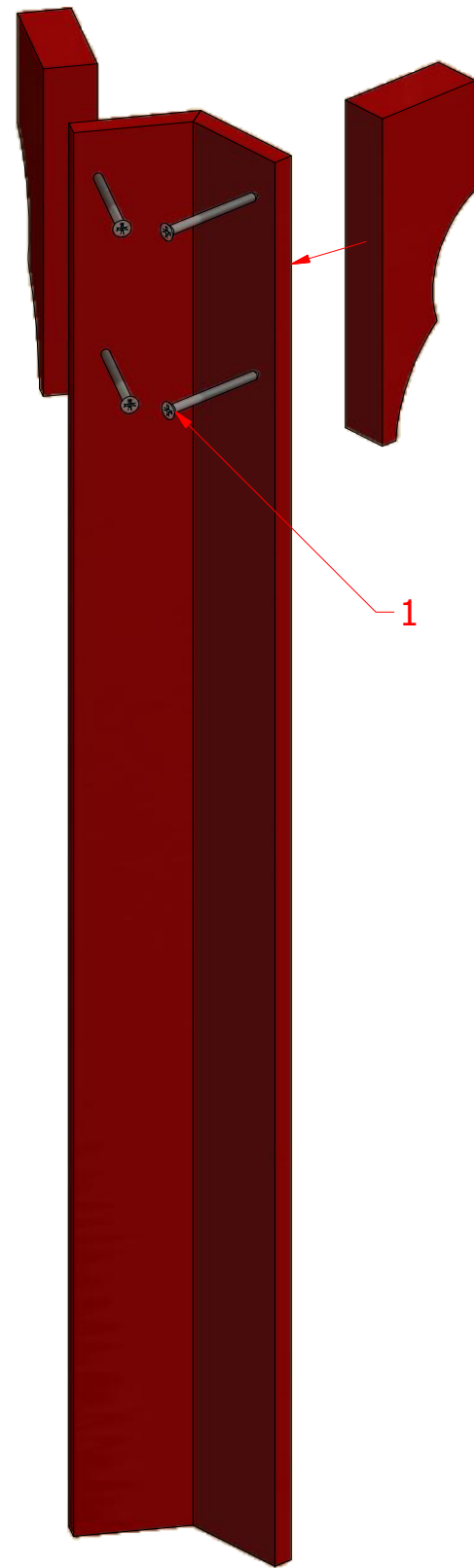

3.1

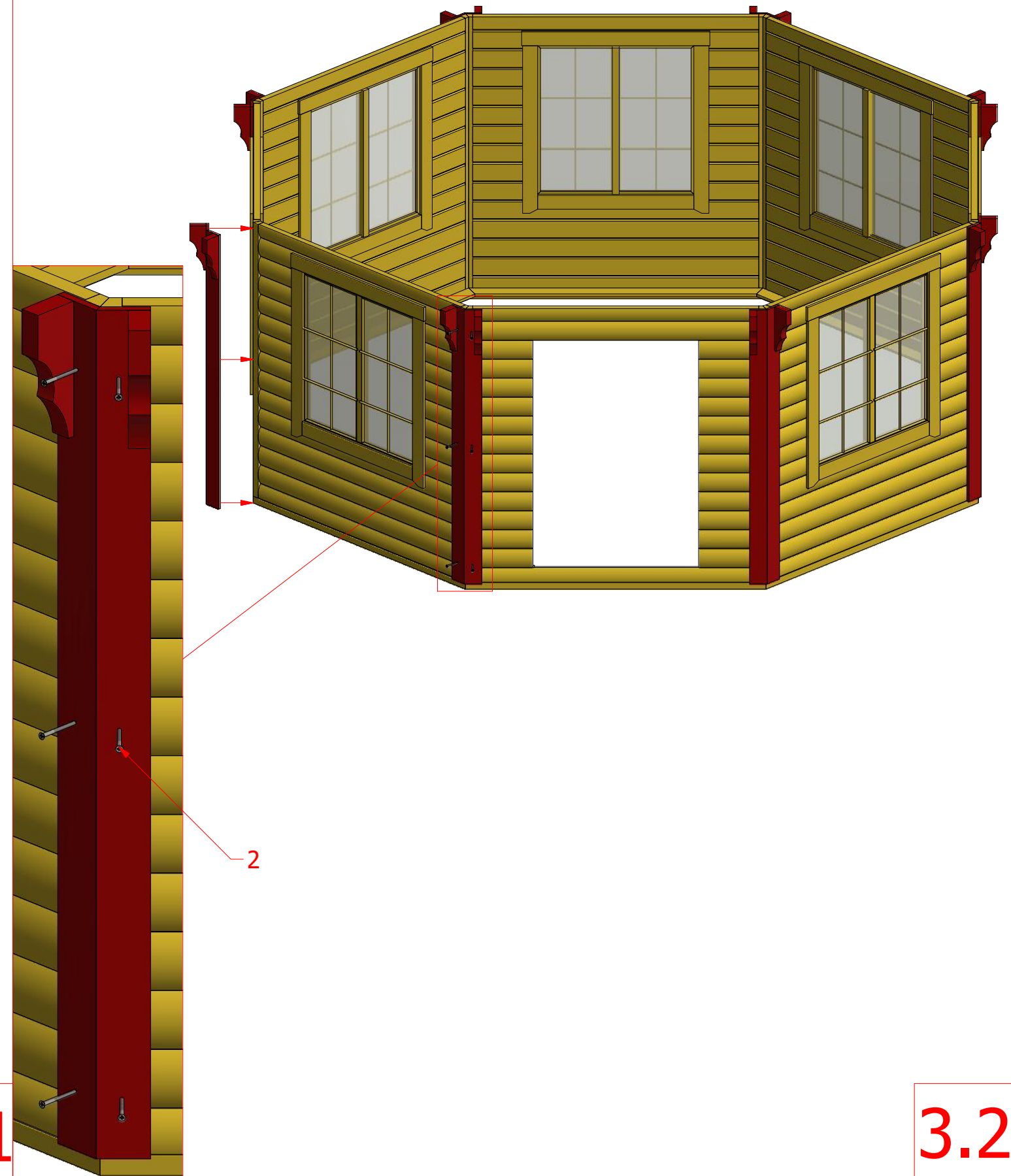

3.2

# Pavilion 16.5 m<sup>2</sup>

## Screws

1	S2	4x70	56 pcs

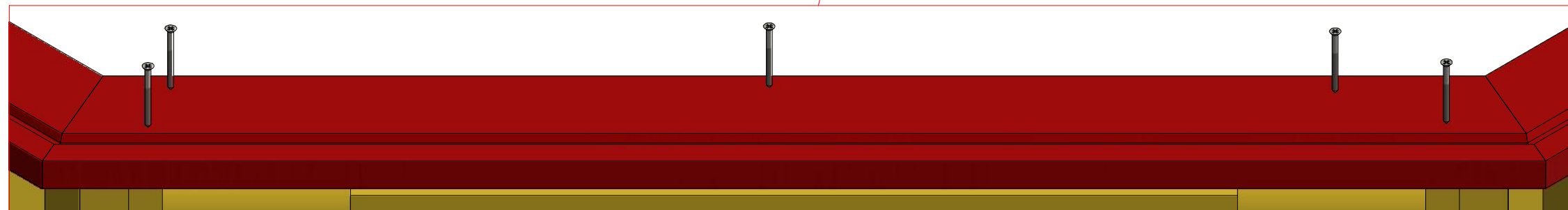
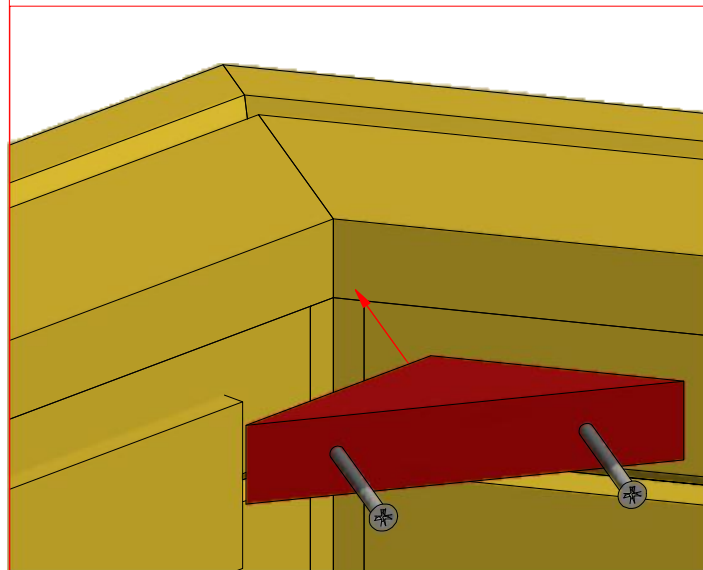
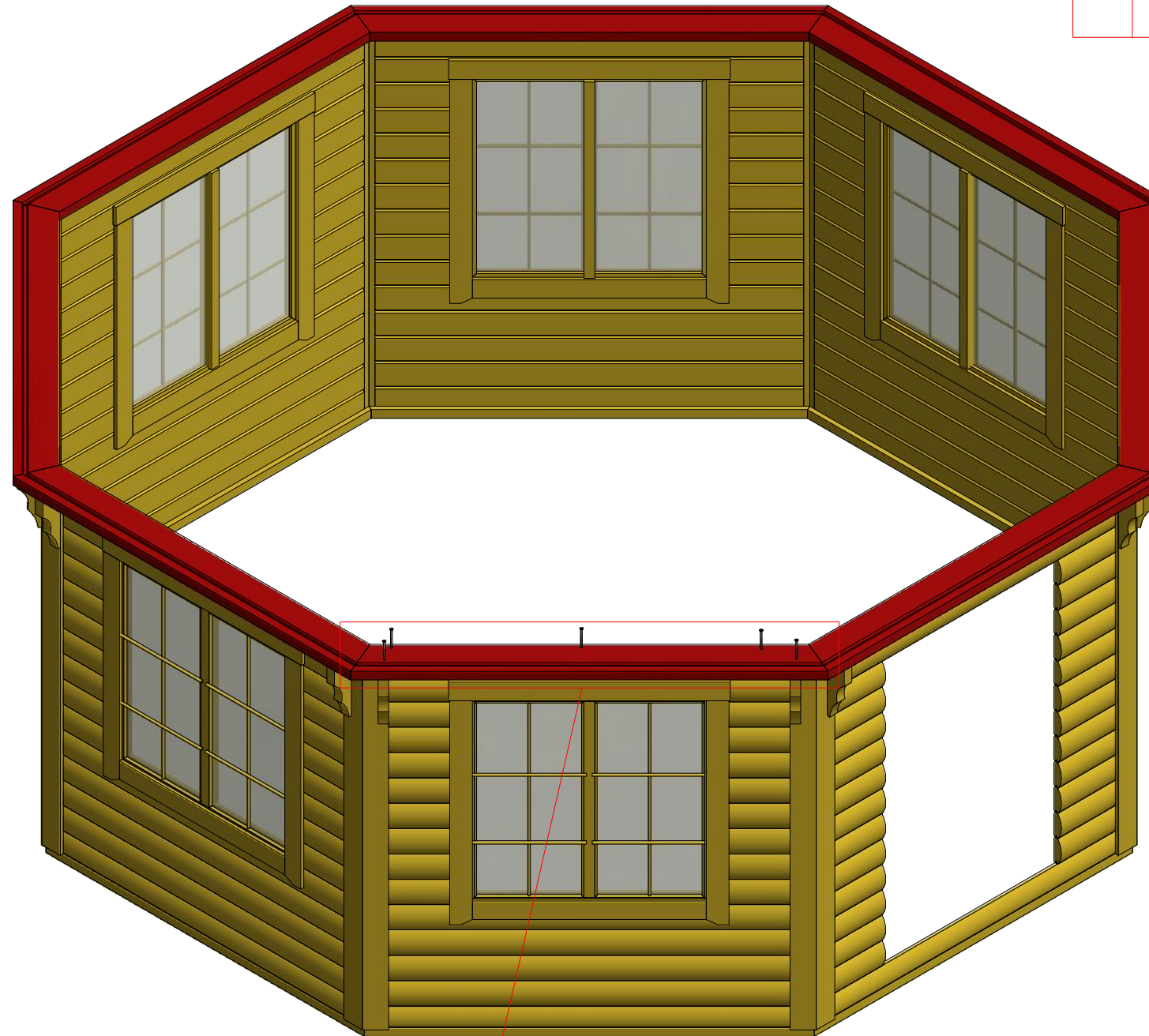



# Pavilion 16.5 m<sup>2</sup>

## Screws

1	S2	4x70	56 pcs

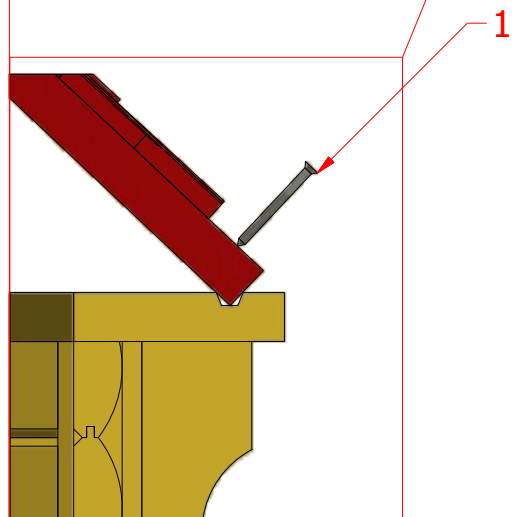

# Pavilion 16.5 m<sup>2</sup>

## Screws

1	S3	3.5x45	32 pcs
2	V1	2.5x25	

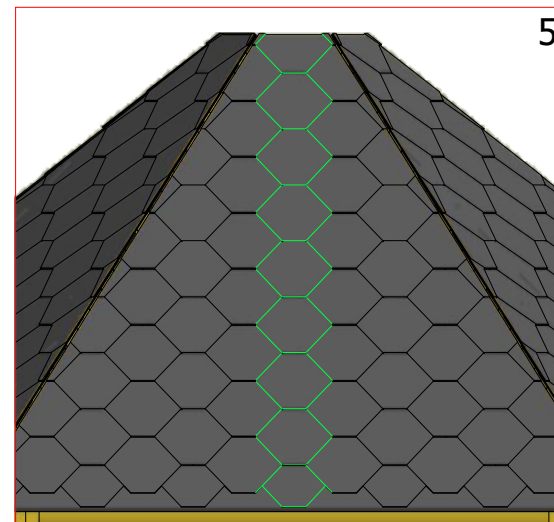
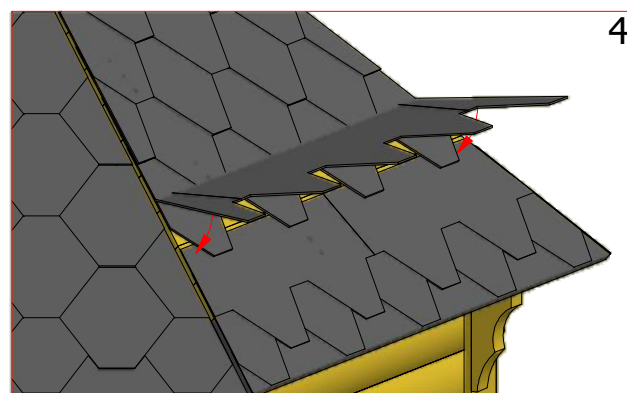
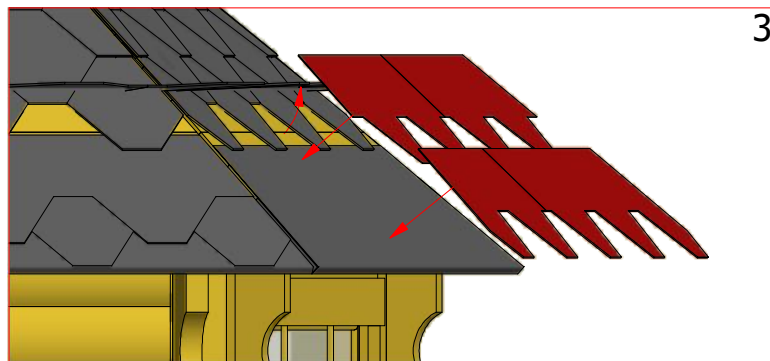
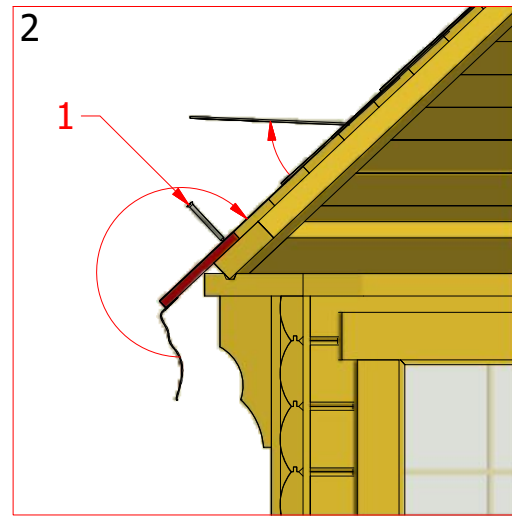
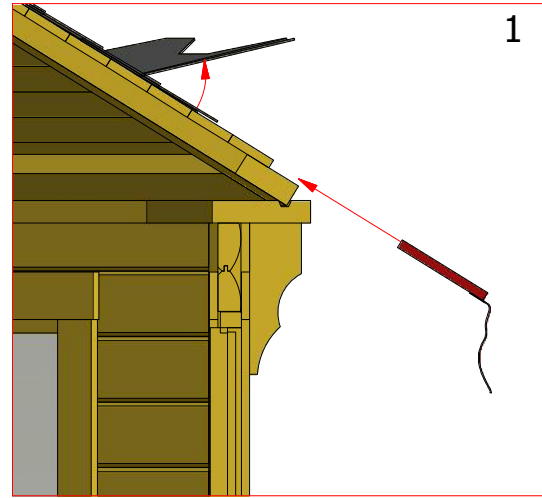



# Pavilion 16.5 m<sup>2</sup>

## Screws

1	S3	3.5x45	32 pcs

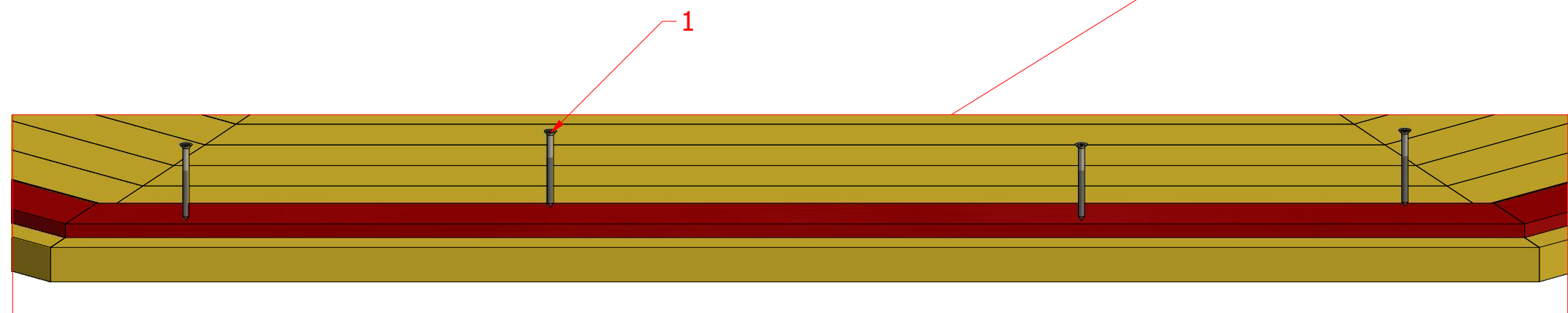
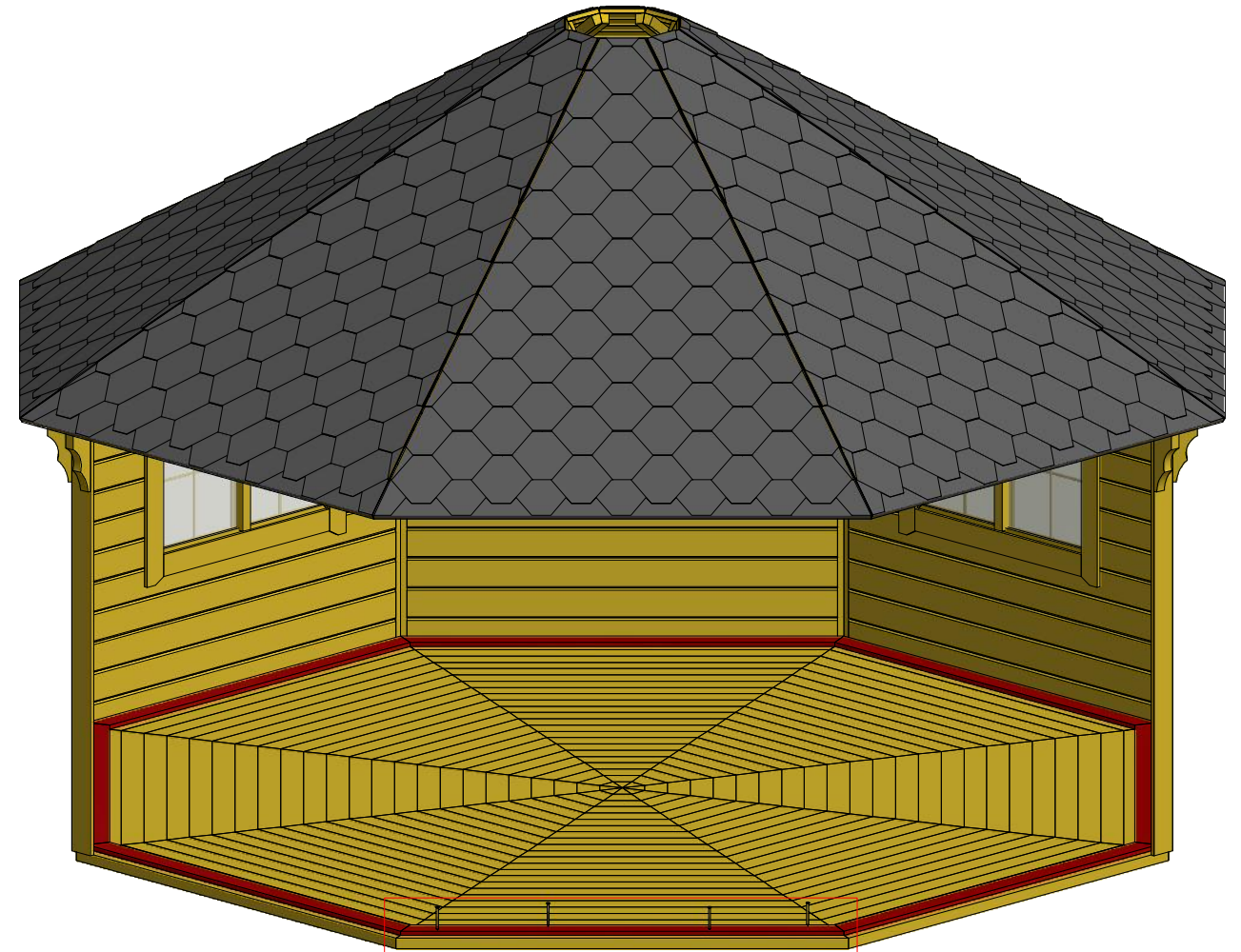
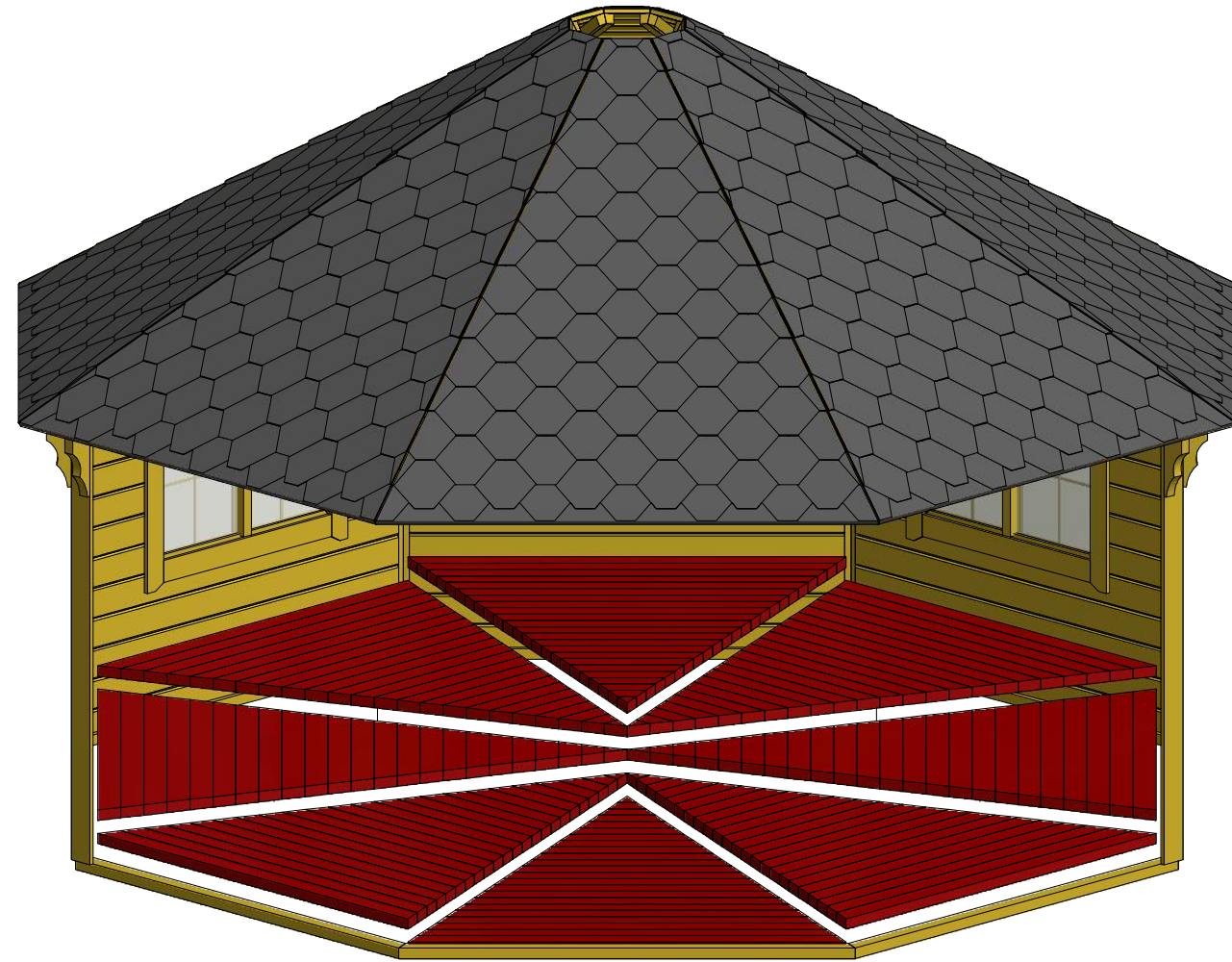



# Pavilion 16.5 m<sup>2</sup>

## Screws

1	S2	4x70	114 pcs
2	S4	3x30	40 pcs

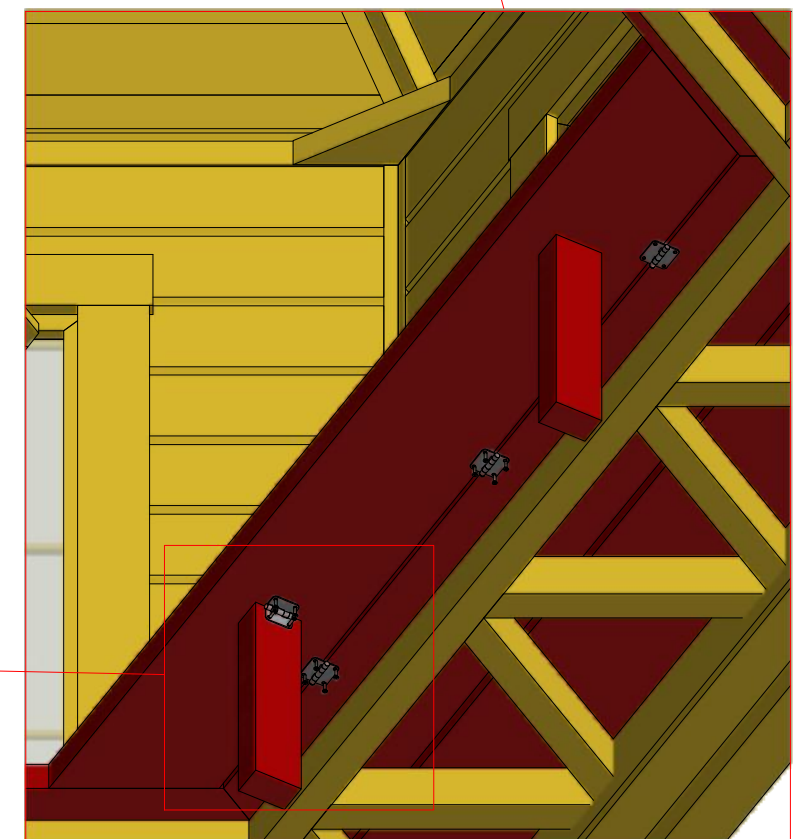
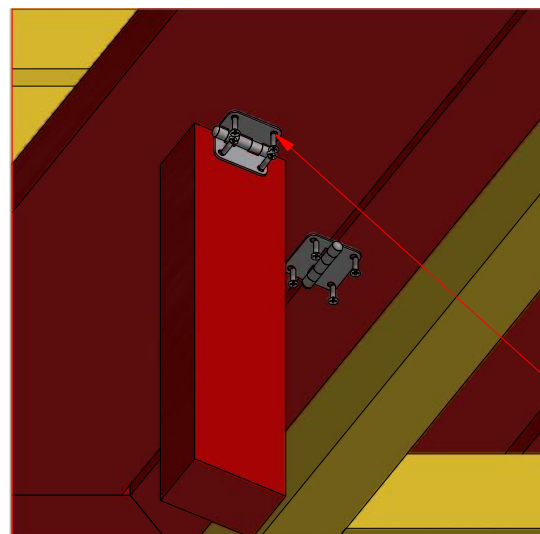
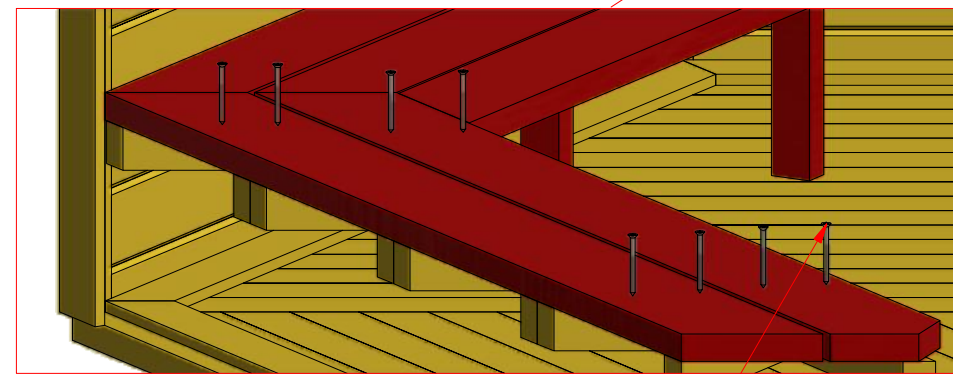
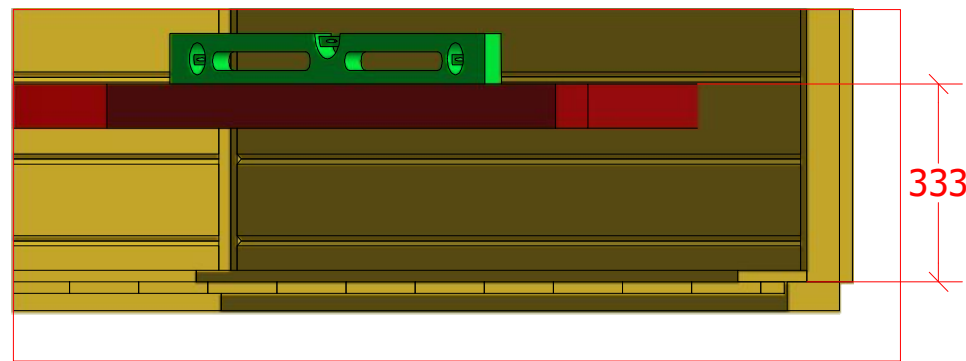
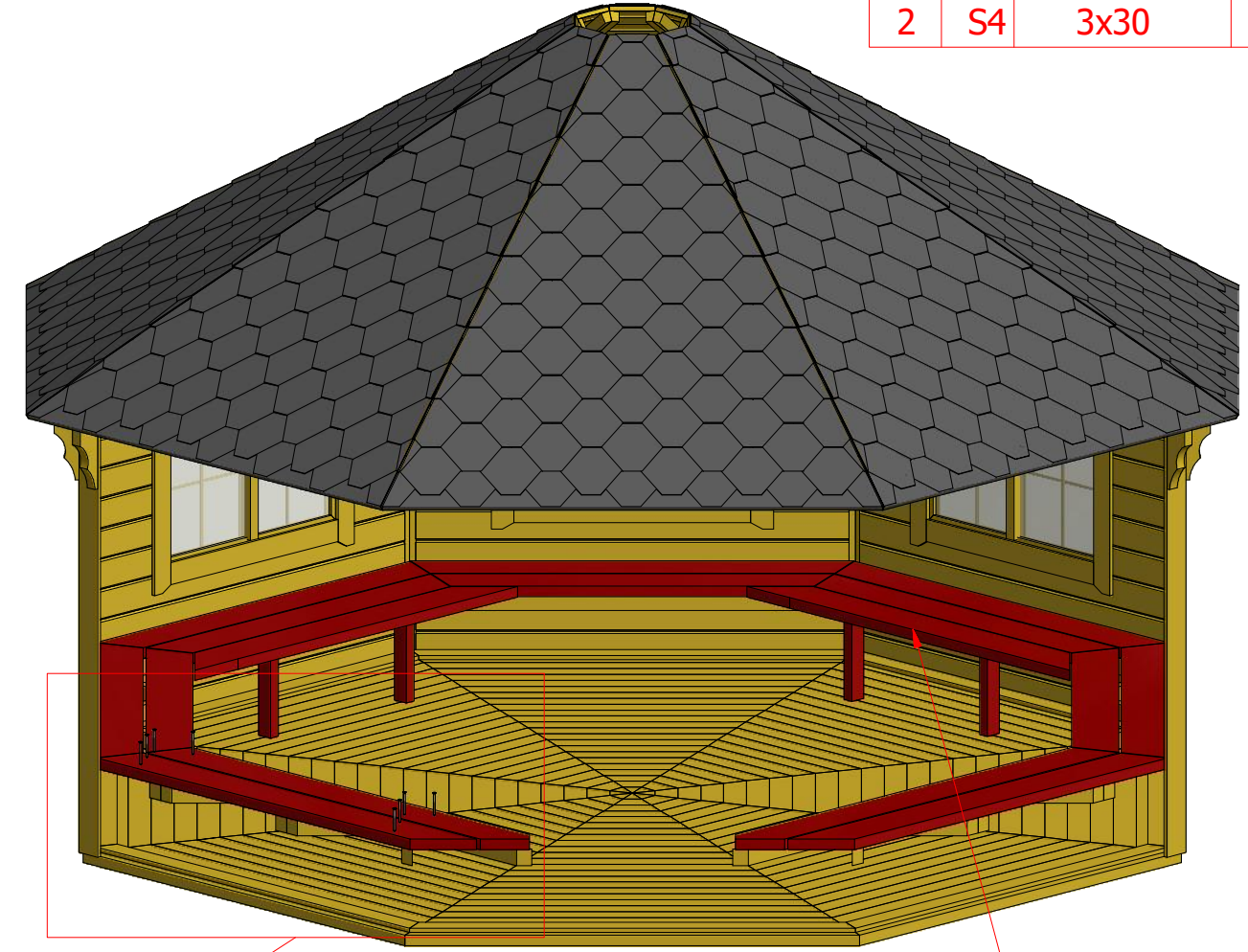
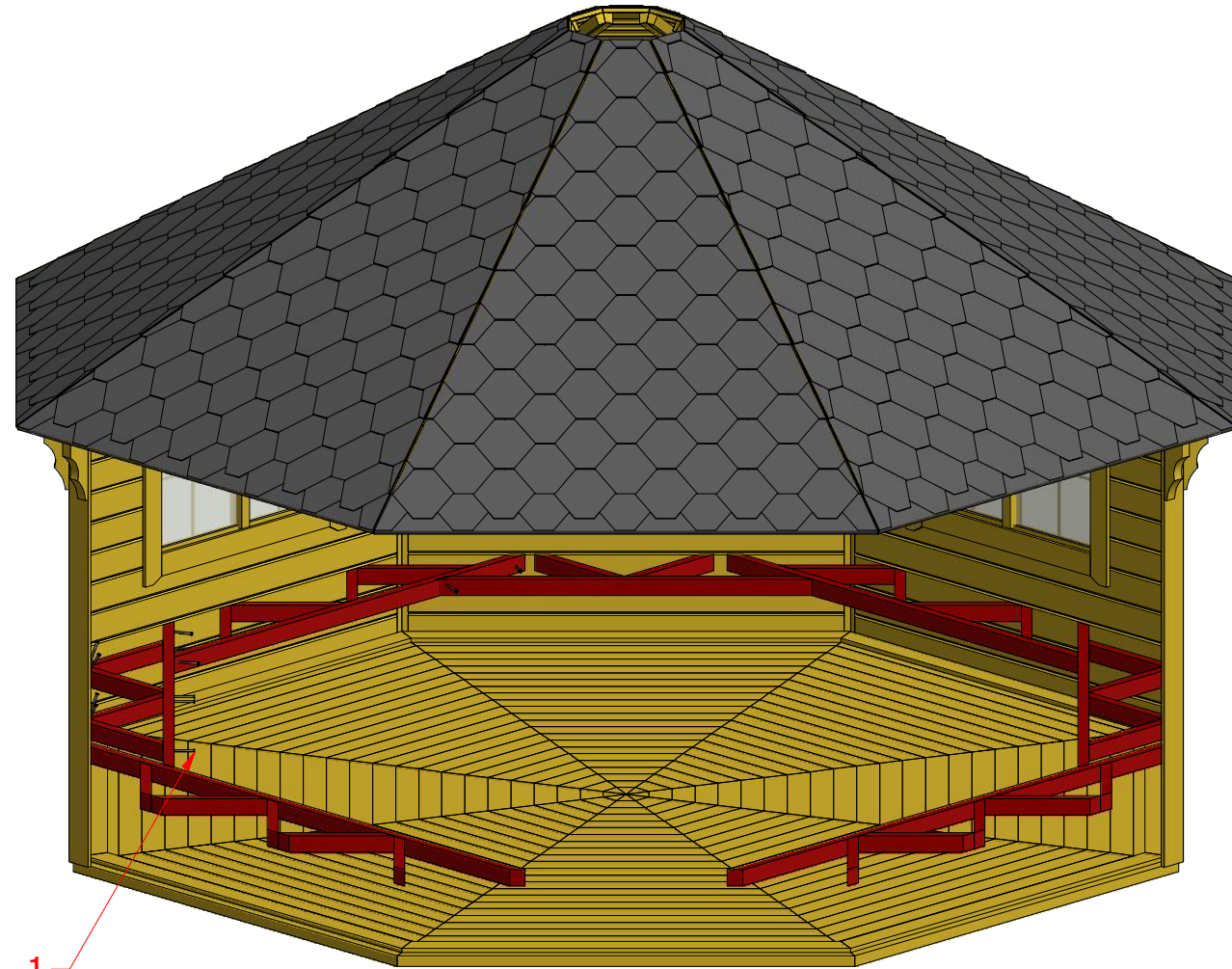



# Pavilion 16.5 m<sup>2</sup>

## Screws

1	S2	40x70	8 pcs

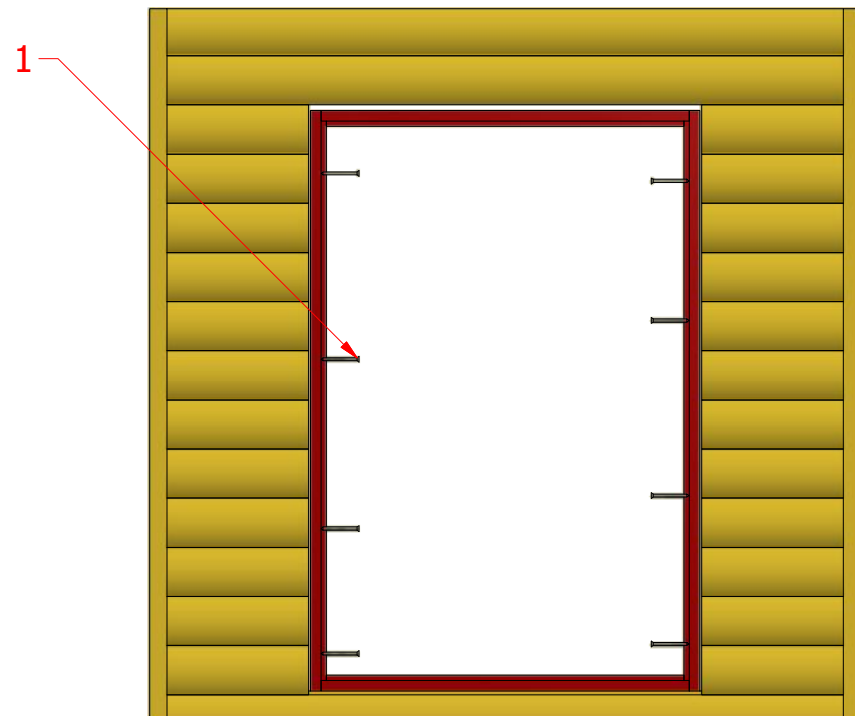
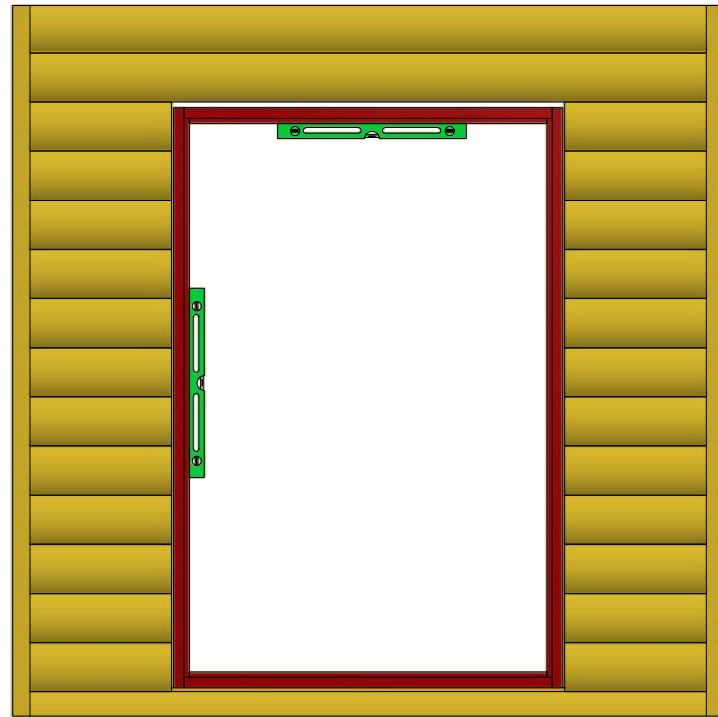

Pavilion 16.5 m<sup>2</sup>

# Screws

1	S3	3.5x45	68 pcs

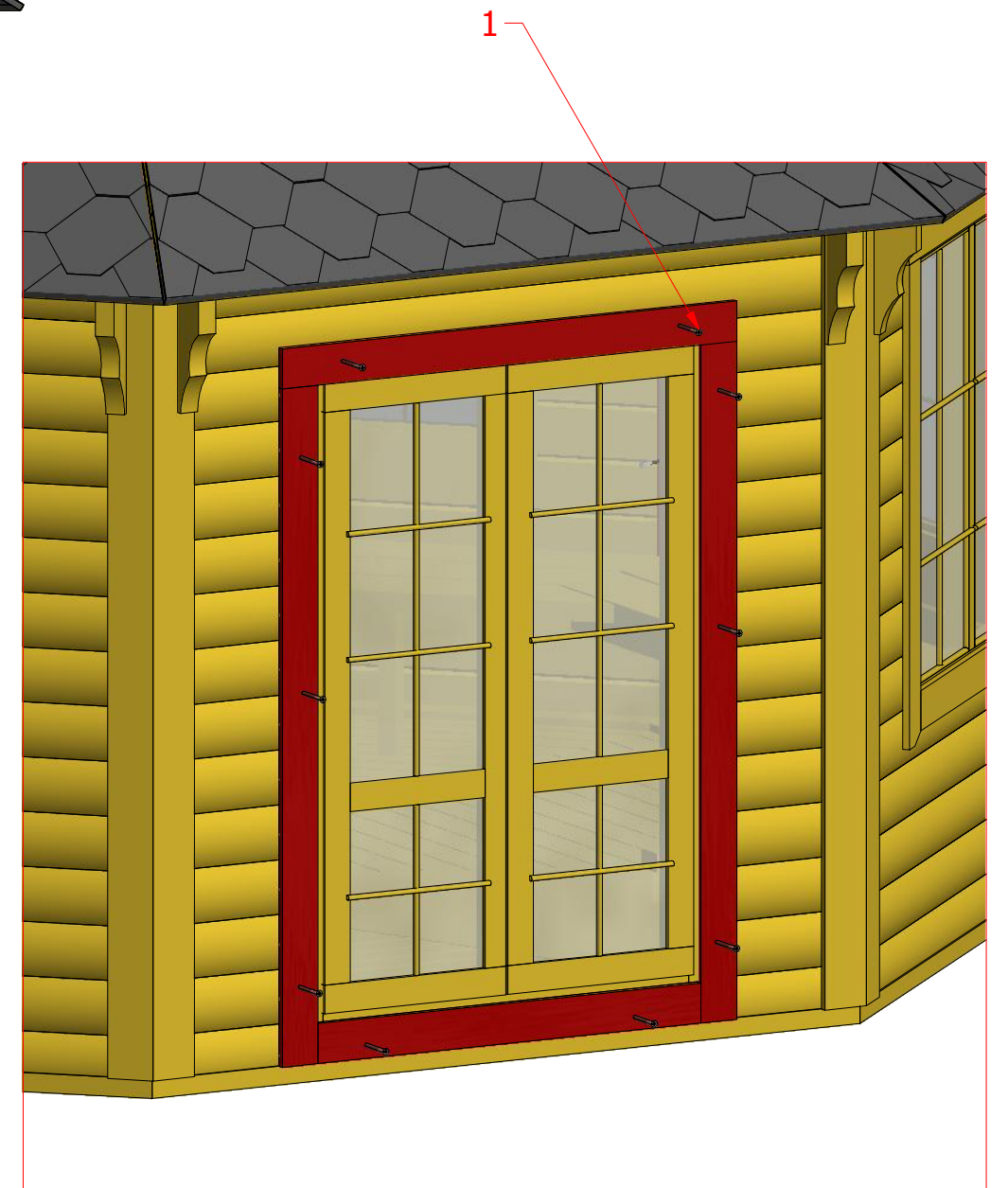



Pavilion 16.5 m<sup>2</sup>

## Screws

1	S2	4x70	4 pcs
2	V1	2.5x25	

