

Microphone **Preamp**

12Mic-D DANTE | MADI

12-Channel digitally controlled
Microphone Preamplifier with Dante, ADAT and MADI



 **Dante**[®]

User's Guide

RME

RME 12Mic-D User's Guide



Table of Contents

1. Safety Precautions	1
2. Introduction	2
2.1. About This Manual	2
2.2. Firmware Update	3
2.3. Controlling the device	4
2.3.1. Sections	4
2.3.2. Tabs	5
2.4. Status Indicator Color Chart	5
3. Hardware	7
3.1. Hardware Specifications	8
3.2. Package Contents	8
3.3. Power On	8
3.4. Standby Switch	9
3.5. Standby Indicator	9
3.6. Analog Input Connectors	10
3.6.1. Analog Input Specifications	10
3.7. Frequency and Impulse Response	11
3.8. Analog Input LEDs with Integrated Metering	11
3.9. LED Meters Color and Intensity Reference	11
3.10. Control Section	12
3.11. Headphone Output	13
3.11.1. Analog Output Specifications	13
3.12. Power supply	14
3.13. MAD1 Coaxial and SFP	15
3.14. Network Connection	16
3.15. Word Clock	17
3.16. USB 2.0 Type B Jack	18
3.17. ADAT Outputs	18
3.18. Mounting the Rack Adapter Brackets	19
4. Accessories	20
5. Dante Connectivity	21
5.1. Identifying a Device Remotely	21
5.2. Changing the Device Name	22
6. Warranty and Support	23
6.1. Warranty	23
6.2. Support	23
6.3. Support Contacts	24
7. STATE Section	25
7.1. Presets	25
7.1.1. Saving Presets	27
7.1.2. Loading Presets	29
7.1.3. Loading Factory Default Settings	29
7.2. Device Lock	29
7.2.1. Locking the Device	30
7.2.2. Unlocking the Device	30
7.3. Front Panel Illumination	31

7.3.1. Dark Mode	31
7.3.2. Changing the Meters to Peak or RMS Mode	33
7.3.3. Persistent Clipping Notifications and Peak Hold	34
7.3.4. Metering of Digital Signals	37
7.4. Remote Control Overview	38
7.4.1. Finding the Device on a Network	38
7.4.2. Static IP Address	39
7.4.3. Web Remote	40
7.4.4. JSON(OSC) Remote Control	41
7.4.5. JSON(OSC) Implementation Chart	43
7.5. Device Information	44
7.6. Power State	44
7.6.1. Notification of Single Power Failure	46
8. INPUT Section.	47
8.1. Analog Inputs	47
8.1.1. Analog Input User Interfaces	48
8.1.2. Adjusting the Input Gain	48
8.1.3. Enabling Phantom Power (P48)	50
8.1.4. Switching Between XLR and TRS Inputs	51
8.1.5. Activating High Impedance (Hi-Z) on TRS Inputs	52
8.1.6. Inverting the Phase of an Analog Input Signal	54
8.1.7. AutoSet	54
8.1.8. Activating AutoSet	55
8.1.9. Gain Groups	56
8.1.10. Creation and Use of a Gain Group	57
8.1.11. Saving, Using and Deleting Gain Groups	58
8.1.12. Monitor Analog Inputs at Phones Output	59
8.2. MADI Inputs	60
8.2.1. MADI at High Sample Rates	61
8.2.2. Connecting Two Identical MADI Signals for Redundancy	61
8.3. Dante Input	62
9. OUTPUT Section.	64
9.1. Routing Signals to the Outputs	65
9.2. Analog Outputs	66
9.2.1. Phones Out	66
9.2.2. Adjusting the Headphone Volume	67
9.2.3. Muting the Phones Output	68
9.2.4. Using Phones Out as a Balanced Line Output	68
9.3. MADI Outputs	69
9.3.1. Setting the Output Channel Format and Frame Pattern	69
9.3.2. MADI Daisy Chains	70
9.3.3. MADI Port Mirroring	70
9.4. Dante Output	71
9.5. ADAT Outputs	71
10. CLOCK Section	72
10.1. Clock Status	72
10.2. Leader Clock	72
10.2.1. Synchronizing to External	74

10.3. Sample Rates Overview	74
10.3.1. Number of Channels	75
10.3.2. Number of Channels	75
10.3.3. Selecting a Sample Rate	75
10.3.4. Effects of Sample Rate Changes on Existing Routing	76
10.4. Set Word Clock Output to Single Speed	77
11. Annex	78
Glossary	79
11.1. Regulatory Compliance	79
11.1.1. CE Compliance	79
11.1.2. FCC Compliance	79
11.1.3. Note on Disposal	80

1. Safety Precautions

⚠ WARNING	
	<p>DO NOT OPEN DEVICE - RISK OF ELECTRIC SHOCK</p> <p>The unit has non-isolated live parts inside. No user serviceable parts inside. Refer service to qualified service personnel.</p>
⚠ CAUTION	
	<p>General Safety Information</p> <p>Read read the following safety information thoroughly and keep it in a safe place for later reference.</p> <p>KEEP AWAY FROM WATER AND MOISTURE</p> <p>Prevent moisture and water from entering the device. Never leave objects containing liquid on top or near the device. Do not use this product near water, i. e. swimming pool, bathtub or wet basement. Danger of condensation inside - do not turn on before the device has reached room temperature.</p> <p>ENSURE PROPER VENTILATION</p> <p>Do not cover the vents on the side of the unit. Ensure proper ventilation to avoid overheating. The maximum ambient operating temperature of the device is 35° C (95° F).</p> <p>MAINS</p> <p>The apparatus shall be connected to a mains socket outlet with a protective earthing connection. Do not use defective power cords. Ensure that the AC socket outlet for the device or an external power supply is easily accessible.</p> <p>Operation of the device is limited to the description in this manual.</p>
NOTICE	
	<p>Read the User Manual</p> <p>Read the manual completely before using the product. It includes all information necessary to use and operate this device.</p>

2. Introduction

Thank you for purchasing the 12Mic-D.

The **12Mic-D** is a 12 channel microphone preamplifier designed to be the centerpiece of any professional recording. Among its outstanding features: digital no-compromise studio quality converters, remote control, integrated Dante® and MADI connectivity, and a user interface optimized for rapid configuration and control.

While all 12 front-facing XLR connectors accept microphone and line level signals, the first four connectors also accept TRS connectors with switchable high impedance (Hi-Z) for instruments. The PAD-free microphone input stages have a 75 dB gain range and accept signals of up to +18 dBu.

The device state can be inspected and modified directly on the front panel with an encoder knob, a display, four buttons that change their function depending on the current feature, and a button on each input channel. It is possible to rapidly create gain groups, switch phantom power and route signals to the headphone without entering complex submenus.

By integrating Audinate's Dante® IP Core on a custom built RME FPGA platform, RME is not only delivering a highly flexible solution but also gets one step closer to achieving a truly universal Audio Networking experience. Any signal reaching the 12Mic-D can be routed and streamed over IP networks, including MADI signals!

The coaxial MADI port and a slot for a second, independent or redundant optical MADI port (SFP module) can be used for daisy chaining, merging and converting MADI signals with lowest latencies. In addition, three optical ADAT output ports for up to 24 channels at single speed (for example a combination of microphone inputs, MADI signals and Dante® signals) or 12 outputs at 96 kHz sampling rate offer compatibility to a wide range of audio interfaces.

Multiple layers of redundancy make this product the perfect fit for live sound applications. Two fully redundant network ports are implemented for Dante® redundancy. The MADI ports support RME's MADI redundancy implementation. And even the power inlet allows for redundancy with an optional external DC power supply in addition to the IEC connector.

A web frontend offers convenient access to the device controls and its integrated routing matrix. The integrated matrix allows free routing between analog inputs and headphone outputs, as well as all channels of both MADI ports, Dante®, and three ADAT outputs.

2.1. About This Manual

This document was created for firmware **1.0.3** on **2022-10-24**. For an updated firmware, please check <https://www.rme-audio.com>.



This manual is also available online, with extended information on using the web remote. Please visit <https://docs.rme-audio.com/12micd>.

The following manual provides a detailed explanation of features and their proper use. Please read the safety instructions carefully.



Features described in this manual may change when the device firmware is updated. It is therefore recommended to refer to the latest version of the manual available online.

Although the contents of this manual have been thoroughly checked for errors, RME cannot guarantee that it is correct throughout. RME does not accept responsibility for any misleading or incorrect

information within this guide. RME reserves the right to change specifications at any time without notice.

2.2. Firmware Update

New and improved features for this device, as well as bug fixes, are published on the RME website in the download section as a firmware update. The update is provided as a compressed file with a **.swu** extension and can be uploaded via web remote over USB or network.

To update the 12Mic-D:

1. Connect the device by USB or network cable and open the Web Remote.

See: web remote

2. Download the current firmware from the RME website.
3. Unpack the compressed file.
4. Open the **Settings** in the Web Remote.
5. Within the **Firmware Update** section, press the **Select .swu Firmware File** button and locate the unpacked file.
6. Press **Start Firmware Update**.



The unit retains all settings, including presets, when the firmware is upgraded.

2.3. Controlling the device

The 12Mic-D can be controlled directly at the unit. For this purpose, a display, buttons, and an encoder provide access to all features. From the main screen, the encoder knob is used to access the main menu. It also controls the gain of the headphone output if turned, and puts the device into standby mode if pushed for several seconds.

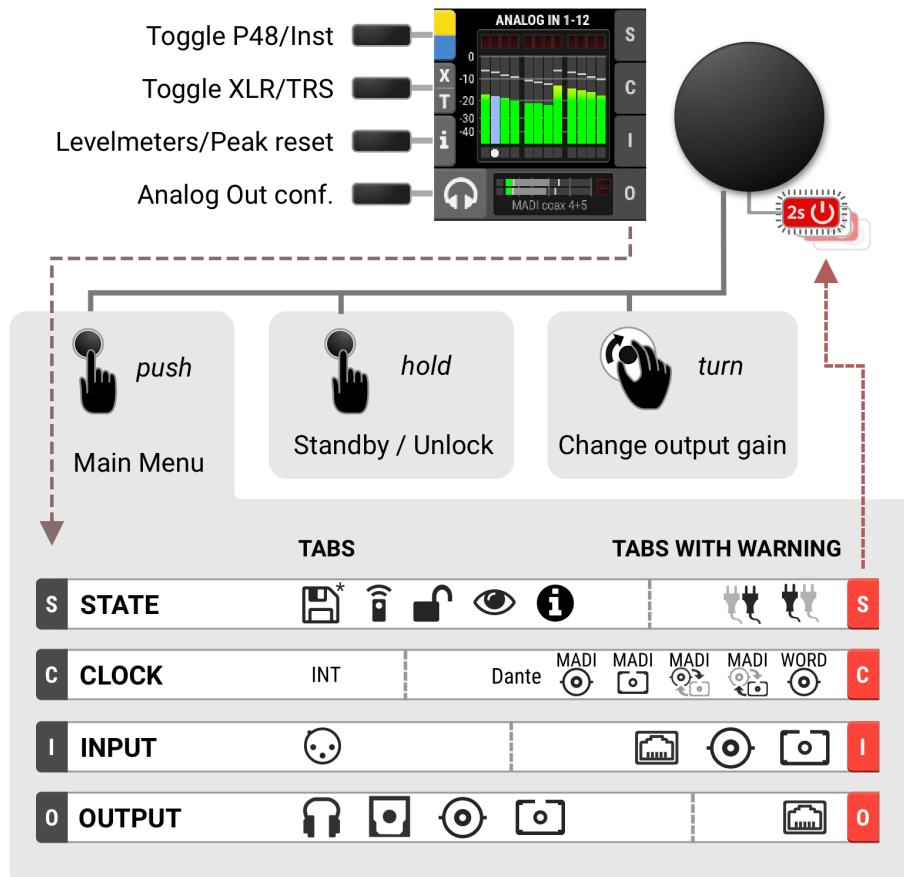

2.3.1. Sections

The main menu separates all controls into one of four sections:

- **STATE** for general settings
- **CLOCK** for digital clock related settings
- **INPUT** for audio input related settings
- **OUTPUT** for audio output related settings and routing

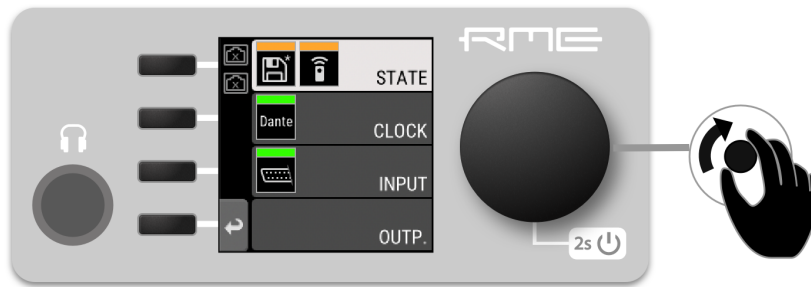



To access the *INPUT* section:

1. Push the encoder to open the menu
2. Rotate the encoder to highlight the "INPUT" section
3. Push the encoder to open the "INPUT" section.

2.3.2. Tabs

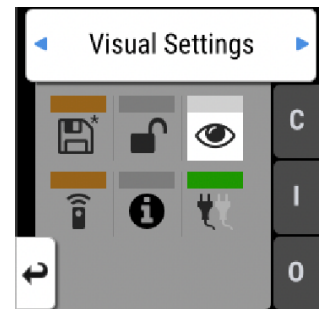
The **STATE**, **INPUT** and **OUTPUT** sections are further divided into **tabs**, which are shown when the section is opened. Upon opening one of these sections, a cursor is shown to navigate between tabs and settings.



To leave a tab or the section, use the return button: .

Tabs can generate a **warning** whenever a configured signal path cannot be established. This is then indicated on the main screen as a red highlight of the corresponding section and in the main menu. Warnings occur for example when a clock reference signal does not match the internal sample rate. They also cause the standby LED to flash in white and red.

Tabs in the main menu can also show a 'caution notification' (orange), for example if a modified preset was not saved. To see these notifications, open the main menu by pushing the encoder.

2.4. Status Indicator Color Chart

Notifications on this device have been optimized for different screen sizes. They are unified across the device display and the web remote and include a color bar that indicates the current state at a glance.

The following table shows the possible status indicator colors for reference.

Status	Color	Description
Warning	red	Requires a configuration change or matching external signal.
Notice	yellow	There is a potential issue.
Notice (in progress)	yellow with dots	There is a temporary issue that should resolve automatically.
No Routing	light green	<i>In output section:</i> Output is sending an empty signal.
Issues with Input	light green	<i>On standby screen in output section:</i> Output is working, but issues with input.
Good	green	Everything is working as expected.
Inactive	grey	Feature is not monitored or disabled.

3. Hardware

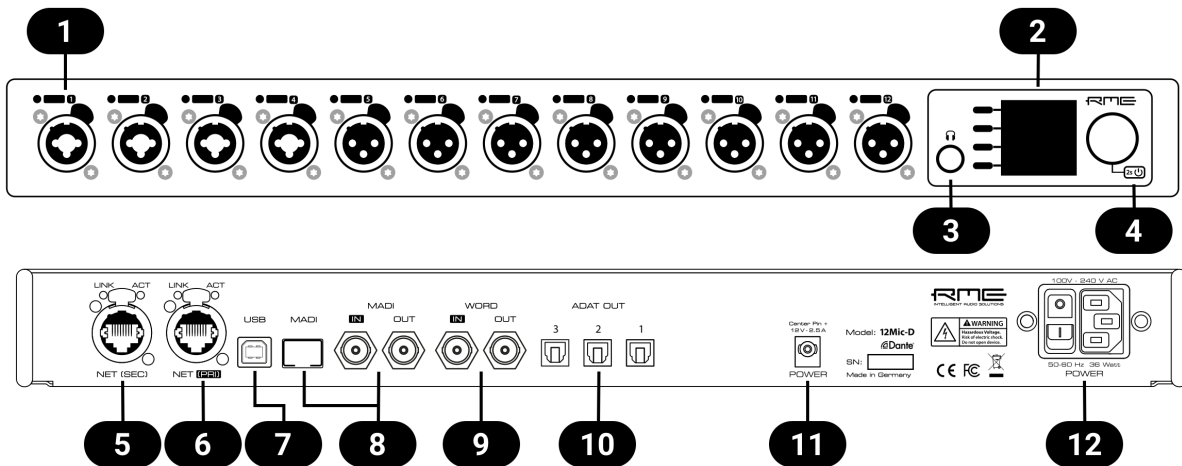

- 1** Section 3.6, "Analog Input Connectors"
- 2** Section 3.10, "Control Section"
- 3** Section 3.11, "Headphone Output"
- 4** Section 3.4, "Standby Switch"
- 5** Section 3.14, "Network Connection", Secondary (SEC)
- 6** Section 3.14, "Network Connection", Primary (PRI)
- 7** Section 3.16, "USB 2.0 Type B Jack"
- 8** Section 3.13, "MADI Coaxial and SFP"
- 9** Section 3.15, "Word Clock"
- 10** Section 3.17, "ADAT Outputs"
- 11** Section 3.12, "Power supply"
- 12** Section 3.12, "Power supply"

3.1. Hardware Specifications

	RME 12Mic-D
EAN	42 6012336 341 3
Dimensions	440 x 44 x 243 mm (17.3 x 1.7 x 9.6 inches)
Weight	2.8 kg (6.2 lbs)
Package	560 x 315 x 115 mm (22.1 x 12.4 x 4.5 inches)
Conformity	CE, FCC, WEEE, RoHS
Power supply	internal 36 W 100-240 V AC external 12 V d.c. 2.5 A (PS2) <i>optional</i>
Power consumption	typ. 20 W, standby 0.5W

3.2. Package Contents

The package of the 12Mic-D contains the following items:

- 12Mic-D
- two rack mount brackets
- four screws for rack mount brackets
- one power cord
- one Cat5e network cable
- printed manual



If any item is missing from a factory-sealed package, please contact your support immediately.

3.3. Power On

The 12Mic-D has a power switch at the AC inlet and a standby switch at the front.

Perform the following steps to power on the 12Mic-D:

1. Ensure that one of the power inlets is properly connected to a power source.
2. When using the AC inlet, toggle the mains switch at the back of the device to position **I** (*down*). The power indicator will light up in red (Standby) or white (On). This depends on the state of the device before it was disconnected from a power source.
3. If the device is in standby mode, hold the encoder for two seconds to boot the device.



The 12Mic-D features a dark mode which deactivates some or all lights of the front panel. This can be used to let the device appear powered off when it is in fact powered on. A short push on the encoder or any button deactivates this mode temporarily.

3.4. Standby Switch

The front panel encoder acts as a standby switch. While in standby mode, the device is completely powered down except for a red LED. No signals are processed or passed on.

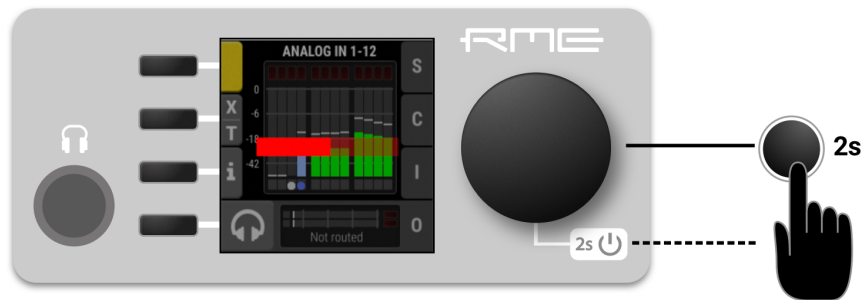

Possible actions:

- When the device is in standby mode, pushing the encoder **for two seconds** will boot the device.
- When the device is powered on, push and hold the encoder for several seconds in order to power down the device. A red progress bar is shown while the encoder is pushed.

3.5. Standby Indicator

The following illumination patterns are possible:

No illumination



- There is no power at either of the two power inlets.
- The power switch at the rear of the device is set to 'Off'.
- Dark mode has been activated.

Permanent red illumination



- The device is **powered off** but is receiving power at either one of the power inlets.

Permanent white illumination



- The device is **powered on** and all systems are working without warning.

Alternating red/white illumination



- Something is not working properly. This is triggered when one of the four display sections: **STATE, INPUT, OUTPUT, or CLOCK** signals a **warning**.

3.6. Analog Input Connectors

XLR/TRS combo jacks 1-4

On the front of the device, four combined XLR/TRS inputs labeled "1" to "4" can be used for microphone, line and instrument signals. Phantom power (48 V) for microphones can be activated on each XLR input, high impedance ("Hi-Z") can be activated when using unbalanced TS connectors. Both XLR and TRS jacks accept balanced signals and maintain full symmetry internally all the way to the A/D converter. Phantom power is not applied at the TRS inputs.

XLR inputs 5-12

Eight additional XLR inputs labeled "5" to "12" can be used for microphone and line level signals. The internal circuits are identical to the first four channels in XLR mode, with a fully symmetrical design.



When using unbalanced XLR, be sure to connect pin 3 (negative/"cold") to pin 1 (ground), to avoid noise from the unconnected pin 3 input.

3.6.1. Analog Input Specifications

XLR In 1-12

- Input: XLR, electronically balanced
- Input impedance: 3.4 kOhm
- Gain range: 75 dB, 1 dB steps
- Resolution AD: 24 bit
- Frequency response @ 44.1 kHz, -0.1 dB: 8 Hz – 20.8 kHz
- Frequency response @ 96 kHz, -0.5 dB: 4 Hz – 29.2^[1]
- Frequency response @ 192 kHz, -1 dB: 3 Hz – 43.7^[1]
- THD @ 30 dB gain: < -110 dB, < 0.00032 %
- THD+N @ 30 dB gain: < -104 dB, < 0.00063 %
- Channel separation: > 110 dB
- Signal to Noise ratio (SNR): > 117 dB RMS unweighted, > 120 dB(A)
- Equivalent Input Noise (EIN), 30 dB Gain: 123 dB RMS unweighted, 125.5 dB(A) @ 150 Ohm
- Maximum input level, Gain 0 dB: +18 dBu
- Maximum input level, Gain 75 dB: -57 dBu

^[1] *optimized impulse response filter, see Section 3.7, "Frequency and Impulse Response"*

TRS In 1-4

As above, but:

- Signal to Noise ratio (SNR): 115 dB RMS unweighted, 118 dBA
- TRS jack, balanced
- Gain range: 42 dB, 1 dB steps
- Maximum input level, Gain 8 dB: +20 dBu
- Maximum input level, Gain 50 dB: -22 dBu

- Switchable high impedance (unbalanced TS): 1 MOhm

3.7. Frequency and Impulse Response

The A/D converters of the 12Mic-D are optimized for extremely low latencies (Short Delay IIR filters). At single speed, the conversion prioritizes frequency response to ensure linear conversion across the entire frequency band.

At double and quad speed (88.2 kHz and higher), the conversion has been optimized to deliver a near-perfect impulse response. This is achieved by allowing a lower cutoff frequency and a slower roll-off of the anti-aliasing filter. It shifts from around 44 kHz to 25 kHz at 96 kHz (84 kHz to 32 kHz at 192 kHz) and attenuates higher signals less steeply. The resulting impulse response shows significantly less ringing artifacts than steep filters at a higher cutoff frequency. Since even the lower cutoff frequencies are located well above the audible range, the advantage of the improved impulse response outweighs the benefit of a higher cutoff frequency.



If the 12Mic-D is used for scientific research (ultrasonic signals) with measurement microphones that maintain a linear frequency response above 25 kHz, please contact your support for a custom solution.





3.8. Analog Input LEDs with Integrated Metering



Each analog input is accompanied by an LED. Shades of green, yellow, and red represent the current level for each channel. Additionally, each LED shows the active state of phantom power (yellow), active TRS input (white), active High-Z impedance on TS (blue), and participation in a gain group (green) while pressing the corresponding quick select buttons.

3.9. LED Meters Color and Intensity Reference

The following table describes the signal level represented by the backlight color. Each value corresponds to full scale, which is equivalent to the reference level of the corresponding input.

Color	Color name	dBFS
	Green	-54 (barely visible in low light) -40 (barely visible in daylight) -20 (bright green)
	Yellow	-5 (strong yellow)
	Orange	-4
	Red	-1
	Red flashing fast	0 (at least three consecutive samples)

3.10. Control Section

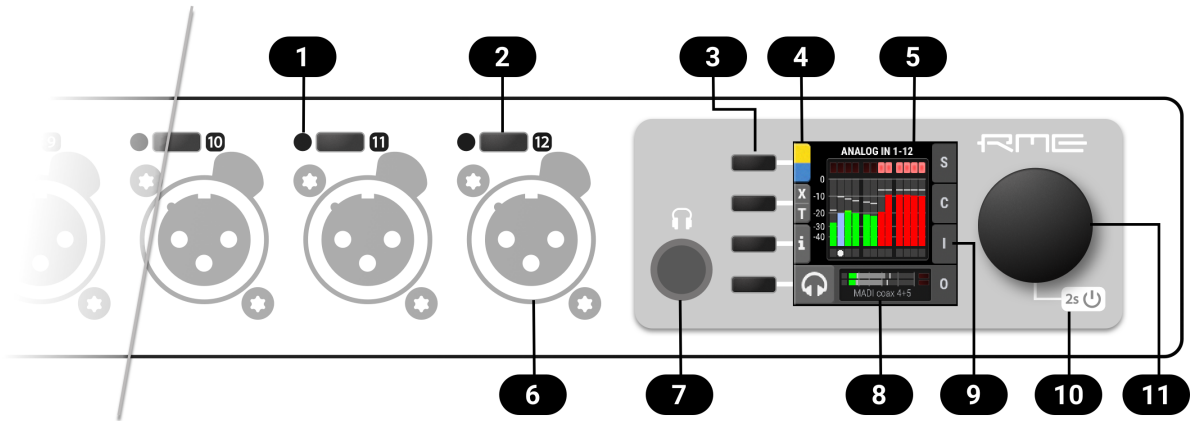

- 1 Section 3.8, “Analog Input LEDs with Integrated Metering”
- 2 Section 8.1.1, “Analog Input User Interfaces”
- 3 Display buttons
- 4 Toggle P48/Hi-Z/TRS
- 5 Display
- 6 Section 3.6, “Analog Input Connectors”
- 7 Section 3.11, “Headphone Output”
- 8 Phones output with routing
- 9 Input tab with warning
- 10 Section 3.4, “Standby Switch”
- 11 Encoder

The 12Mic-D can be configured at the device. To do so, the TFT display shows a menu. The adjacent encoder knob and buttons are used to navigate and change settings. In addition, each input channel has a dedicated button to access its controls.



The encoder can be **pushed** in order to activate an item,



and **rotated** left and right in order to select an item.



If the device is powered on but the display shows no content, **dark mode** is active. Rotate the encoder to temporarily bypass this mode and show the display.

3.11. Headphone Output

The 12Mic-D features a stereo headphone output, 1/4" (6.3mm) TRS on the front panel. It can also function as a dual mono unbalanced output (13 dBu) and as a mono balanced line level output (19 dBu). Any digital or analog input signal can be monitored.



Always use balanced TRS connectors at this output.

3.11.1. Analog Output Specifications

Phones 1/2:

- Resolution: 24 Bit
- Noise (DR): 115 dB RMS unweighted, 118 dBA
- Frequency response @ 44.1 kHz, -0.5 dB: 9 Hz – 22 kHz
- Frequency response @ 96 kHz, -0.5 dB: 9 Hz – 45 kHz
- Frequency response @ 192 kHz, -1 dB: 8 Hz - 75 kHz
- THD+N: < -100 dB, < 0.001 %
- Channel separation: > 110 dB
- Output: 6.3 mm TRS stereo (unbalanced) or mono (balanced) jack
- Maximum output level at 0 dBFS: +13 dBu (unbalanced), +19 dBu (balanced)
- Output impedance: 100 Ω

3.12. Power supply

The 12Mic-D has an internal power supply (PSU) that is connected via an IEC C14 inlet labeled "PSU" at the rear of the device. It is a high performance switch mode power supply that accepts 100V to 240V AC. It is short-circuit-proof, has an integrated line-filter, is fully regulated against voltage fluctuations, and suppresses mains interference.



The **power switch** next to the inlet internally disconnects the line and neutral connection to the internal power supply. Ground will remain connected.

12 V DC inlet

An optional external power supply can be connected instead of - or in addition to - the internal power supply. Redundancy is established when both inlets are connected to a power source. Additionally, both inlets are internally monitored. The 12Mic-D can warn when one of the inlets receives no power.

The power supply must be capable of delivering 2.5 A at 12 V DC and connect with a type A (IEC 60130-10) plug (5.5 mm outer diameter, 2.1 mm inner diameter, positive polarity, optional lock tab).

Insert the connector fully with the lock tabs facing sideways, then gently turn 30 degrees clockwise to secure the connector in place. Reverse this process to unlock and unplug the connector.

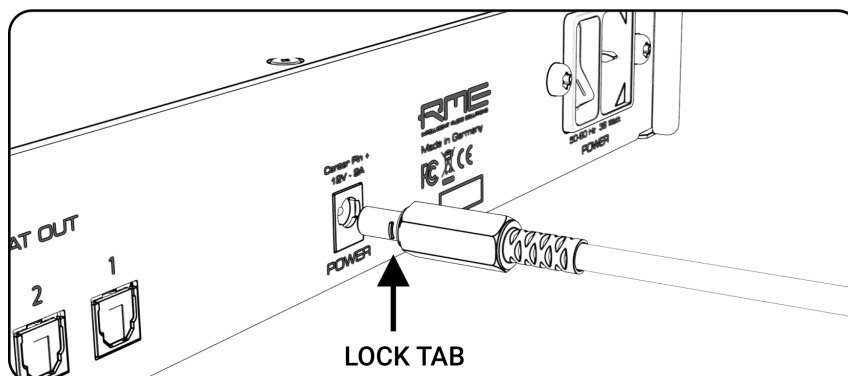

Do not push and turn the connector at the same time as this may damage the DC socket.

3.13. MADi Coaxial and SFP

The rear of the 12Mic-D features coaxial and SFP MADi (AES10-2003) I/O.

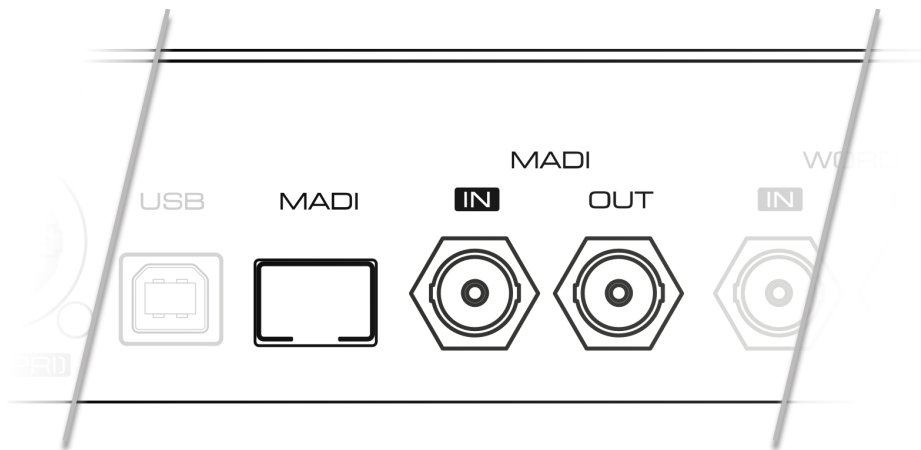

Each input receives up to 64 audio channels. **Auto Input** (see Section 8.2.2, “Connecting Two Identical MADi Signals for Redundancy”) can be activated to treat both inputs as one.

The coaxial BNC connector accepts coaxial cables with 75 Ω impedance.

The “*small form-factor pluggable*” connector (**SFP**) accepts 125 MBit/s transceivers with LC connectors, 1310nm wavelength and multi-mode (MM) or single-mode (SM) cable support. These must be purchased separately (see Section 4, “Accessories”).

An SFP module has indicators to distinguish transmitter (▼) and receiver (▲). It can be inserted and removed while the device is powered on (hot plugging). Any plugged in connector must be removed before unlocking the SFP. Unlock and remove by pulling its integrated wire latch outward.



The wire latch of the SFP module is color coded. Black stands for the most common multimode module, blue stands for single mode which allows longer distance transmissions. It is possible, but not reliable to connect single mode transceivers with multi mode transceivers. Avoid this by always confirming that connected devices match the specification of the fiber optic cable.

On the device, the characteristics and state of the signal at either input can be inspected in the **INPUT** section.

The presence or loss of a signal at either port is indicated on the standby screen and main menu if

- the input port is selected as **clock master**, or
- its audio channels are routed in the **OUTPUT** section.

When using the web remote, the characteristics and state of the signal at either input can be inspected in the **CLOCK** section.

3.14. Network Connection

On the rear of the 12Mic-D, two ruggedized RJ45 connectors labeled **NET (PRI)** and **NET (SEC)** provide ethernet connectivity. The supported link speeds are **1 Gb/s** and **100 Mb/s**.

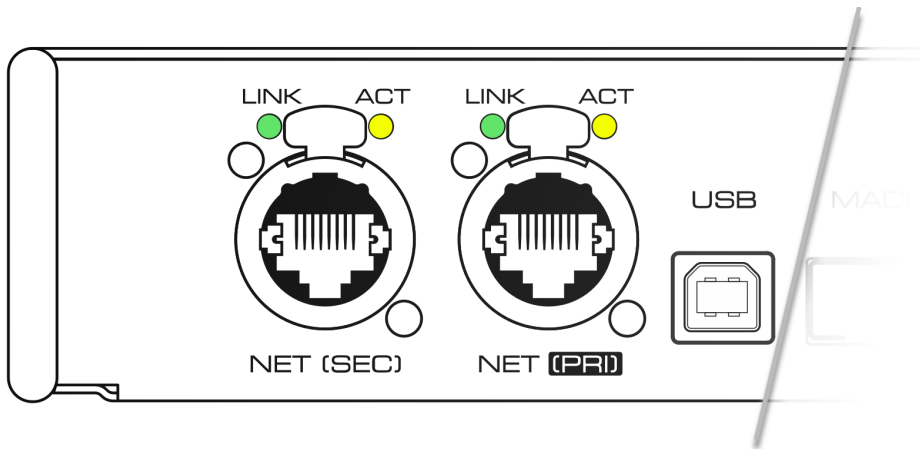

A green LED (left, **LINK**) signals a successful link. A yellow LED (right, **ACT**) signals network traffic (blinking).

Both straight and crossover cables can be used (*Auto MDI-X*). Cable lengths of up to 100m are supported when using Cat 5e or higher classification.

The network ports are used to send and receive:

- up to **64 audio channels** when connected to a Dante® network, and
- remote status/control with **HTTP** over IP routed networks.

The current link state is also shown on the display of the 12Mic-D.

Two network port icons in the menu reveal the following states:

Icon	Description
	No link - cable not connected
	Negotiating link with other endpoint
	Successful link with speed of 100 MBit/s
	Successful link with speed of 1 GBit/s

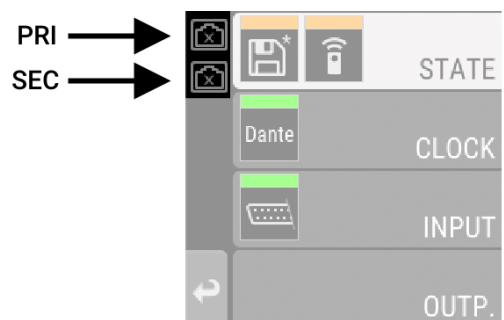

The two ethernet ports can be configured with the **Dante Controller** in *Device View > Network Config > Dante Redundancy*. If both ports are connected to the same network, for example to create a daisy-chain of several 12Mic-D, then the setting must be changed to **Switched**. In the default mode, the device is configured so that each port connects to separate networks (**Redundancy**).

3.15. Word Clock

Word clock can be sent and received via 75 Ω coaxial cabling at the corresponding BNC connectors. The cable length should not exceed 100 m (330 ft).

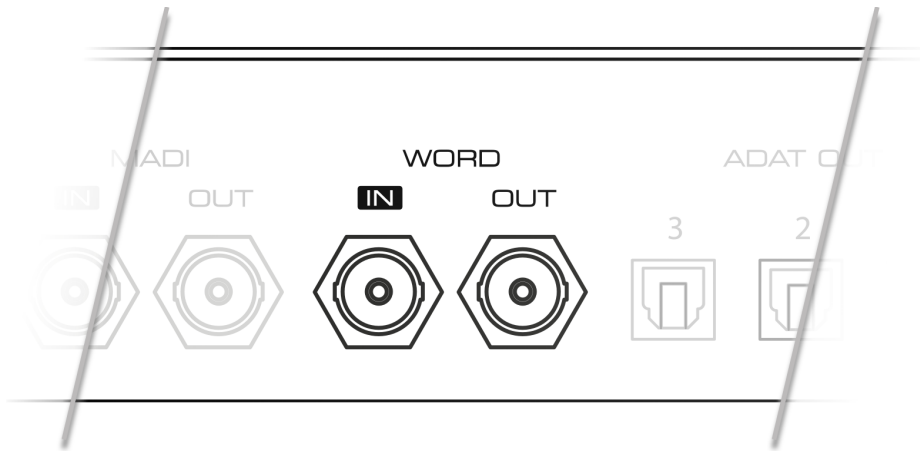

The input is terminated with 75 Ω internally. To pass on the word clock to other devices, use the word clock **output**. Do not connect a T-adaptor to the word clock input.

The state of an incoming word clock signal can be accessed in the **CLOCK** section.

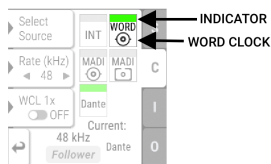

Possible States:

- A **green indicator** shows that the signal is currently in sync with the chosen clock master.
- A **light yellow indicator** means that a word clock is received but is not in sync.
- A **red indicator** means that word clock is chosen as reference, but a signal is not present or has a different sample rate than device.

The state of an incoming word clock signal can be observed in the **CLOCK** section.

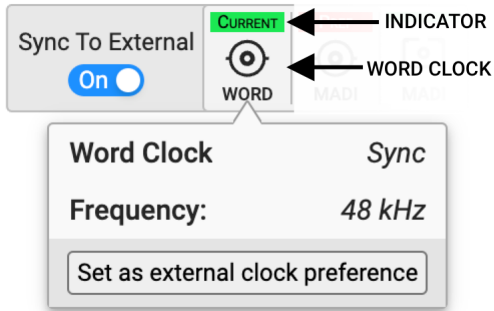

Possible States:

- A **green indicator** shows that the signal is in sync with the current clock reference.
- A **light yellow indicator** means that a word clock is received but is not in sync.
- A **red indicator** means that word clock is chosen as reference, but a signal is not present or has a different sample rate than device.

3.16. USB 2.0 Type B Jack

The USB jack at the rear of the 12Mic-D provides an alternative connection method for web remote control when a network connection is not available.

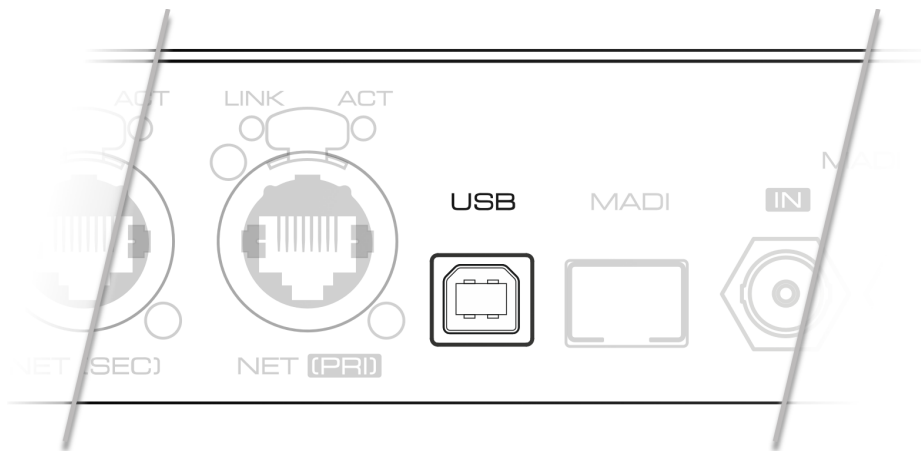

When connecting the 12Mic-D with a standard ("printer") USB 2.0 cable to a current Microsoft Windows™ or Apple macOS™ operating system, a network adapter will be automatically installed. This does not require additional drivers. The device can then be remotely controlled by opening the URL <http://172.20.0.1>.



The USB port cannot be used to stream audio signals.

3.17. ADAT Outputs

Three ADAT outputs can be found at the rear of the device.

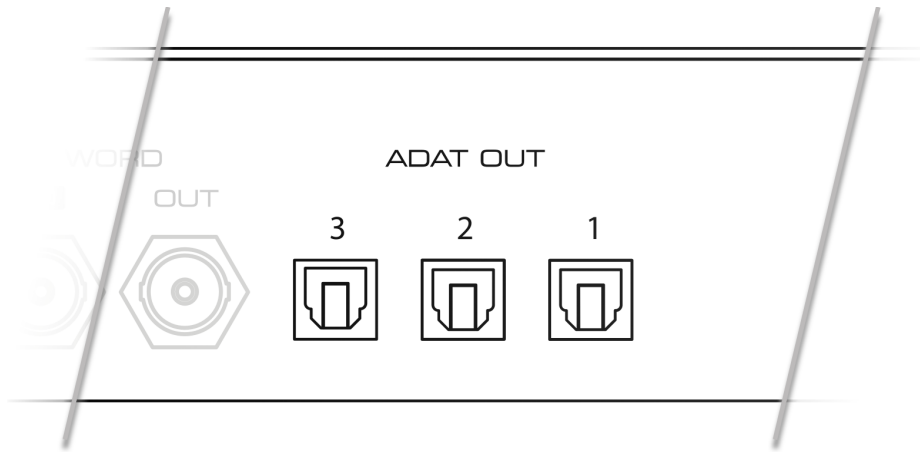

Each port can send up to eight audio channels. At double and quad speed, the maximum of channels per port is reduced to four and two respectively.



Even when no signal is routed, the outputs send a valid ADAT signal at the current sample rate. This can be used to synchronize ('clock') other devices.

The quick start preset sends analog inputs 1-12 to ADAT output ports 1 (input 1-8) and 2 (input 9-12) per default. The factory preset does not route any signal to ADAT outputs.

3.18. Mounting the Rack Adapter Brackets

When the device should be mounted in a 19" rack, the rack adapter brackets must be mounted first.

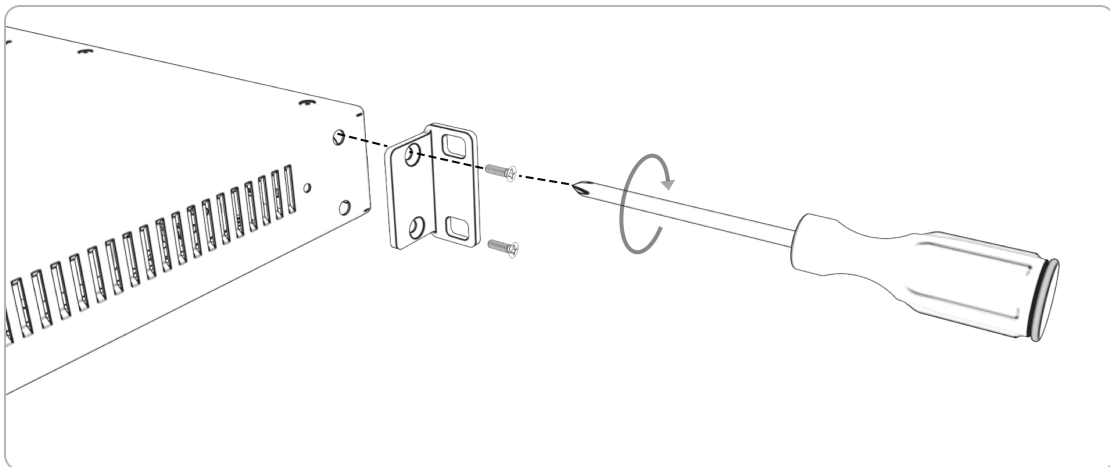

Mount each bracket with two screws using a Philips PH-1 screwdriver.



Do not use screws other than the ones included. Using longer screws can damage the device internally!



Never insert the screws without the rack adapter bracket. This could damage the device!

4. Accessories

RME offers optional accessories for the 12Mic-D:

Part Number	Description
<i>SFP Modules</i>	
MADI-SFP-MM	MADI optical multi-mode module, 2 km, LC
MADI-SFP-SM	MADI optical single-mode module, 20 km, LC

5. Dante Connectivity

The 12Mic-D features Dante®, an Audio-over-IP solution that allows users to transmit uncompressed audio channels over existing network infrastructure.

Network Control

On a Dante® network, connections between devices are managed with a dedicated software: the **Dante® Controller**. It can be downloaded along with extensive documentation and training resources free of charge on the Audinate® website:

<https://www.audinate.com/dc>



The download requires user registration.

This software must be installed on a computer connected to the same network that the 12Mic-D has been connected to. Once connected, the 12Mic-D appears as a device in each of the Dante Controller's main tabs **Routing**, **Device Info**, **Clock Status** and **Network Status**:

Device Name	Model Name	Product Version	Dante Version	Device Lock	Primary Address	Primary Link Speed	Secondary Address	Secondary Link Speed
12mic	12Mic-D	1.0.0	4.2.3.6	<input type="checkbox"/>	192.168.1.116	1Gbps		Link down

Device Control

The number of channels that can be received or transmitted over network is limited to 64 channels (at 48 kHz sampling rate, 1 GigE network connection). It is therefore necessary to create an internal routing from any of the incoming analog or digital signals to the outgoing Dante signals. This routing can be configured on the device itself or with a browser-based remote control.

Clocking on a Dante network

Dante usually handles the synchronization of connected devices automatically.

When more than one device is connected to the same network, one device becomes the "leader", and other devices become "followers". It is possible to prioritize a device so that it would become the leader, but this only works reliably as long as it is the only prioritized device on the network. The configuration of a preferred leader, for example a device that is powered on first or powered on permanently, should therefore be made and inspected with the Dante controller.

When the 12Mic-D is leader, it can either use its internal clock oscillator as a reference, or one of the incoming MADI or word clock signals.

5.1. Identifying a Device Remotely

When several 12Mic-Ds are connected to the same network, each device has its own remote control. To quickly reveal which device is currently being controlled, the web remote can send an **Identify** command

to the unit. This triggers an animation of the front panel level meters of the corresponding device.

To use device identification with the web remote:

1. Open the 12Mic-D web remote in a browser (see *web remote*)
2. Press the **identify**  icon. The icon will start rotating and the front panel level meters of the controlled device will show an animation.
3. Press the same icon again to stop the animation.

5.2. Changing the Device Name

In a Dante® network, the **Device Name** is used to identify each device and to identify its individual audio channels. It must be unique on a network, otherwise a receiver cannot distinguish which device is transmitting the audio channels requested. For this reason, each 12Mic-D unit is given unique names from the factory, similar to "RME12Mic-d65432". The **Device Name** can only be changed by the Dante Controller.

To check the current device name:

1. Open the **System Information** screen in the **State** section (see: *device control*).

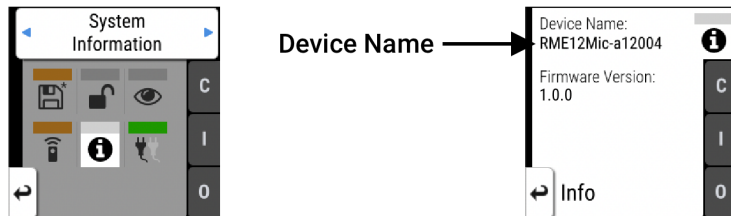

The **Device Name** is also part of the URL for the web remote.

6. Warranty and Support

6.1. Warranty

Each individual 12Mic-D undergoes comprehensive quality control and a complete test before shipping. The usage of high grade components should guarantee a long and trouble-free operation of the unit.

If you suspect that your product is faulty, please contact your local retailer. Do not disassemble the device by yourself as it may get damaged. It has been sealed with tamper-evident material, and your warranty is void if those seals have been damaged.

The distributor grants a limited manufacturer warranty of 6 months from the day of invoice showing the date of sale. The length of the warranty period is different per country. Please contact your local distributor for extended warranty information and service. Note that each country may have regional specific warranty implications.

In any case warranty does not cover damage caused by improper installation or maltreatment - replacement or repair in such cases can only be carried out at the owner's expense.

No warranty service is provided when the product is not returned to the local distributor in the region where the product had been originally shipped.

The distributor does not accept claims for damages of any kind, especially consequential damage. Liability is limited to the value of the 12Mic-D. The general terms of business drawn up by the distributor apply at all times.

6.2. Support

Please ensure that you are using the latest firmware before contacting support.

In many cases, the user forum at <https://forum.rme-audio.de> provides help with a simple search for relevant keywords.

If the problem cannot be solved by any of the aforementioned methods, please have your serial number at hand and contact your local dealer or distributor. A complete list of distributors can be found on the RME website.

6.3. Support Contacts

Additionally, the following global service centers can provide support assistance:

Europe

Audio AG, Germany
support@rme-audio.de

Synthax U.K.
info@synthax.co.uk

Asia/Australia

RME Trading Ltd., Hong Kong
support@rme-trading.hk

Americas

Synthax Inc., U.S.A.
tech.support@synthax.com

Global

support@rme-audio.de

7. STATE Section

The **STATE** section contains states and settings that are unrelated to audio I/O and clock. It can be used to configure power supply warnings, presets, dark mode, level meters, and remote control.

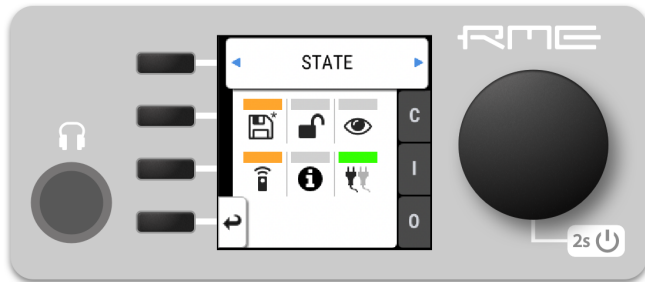

A **warning** (red) is shown when PSU redundancy is activated but only one power supply is active. A **notification** (orange) is shown when a preset is modified, no IP address was assigned to the web remote or any dark mode is active.

7.1. Presets

Any change in the device configuration is persistent. After a power loss, the device will revert back to its last state. Additionally, the 12Mic-D can save fifteen states in presets numbered 1-15. After a preset is loaded, any change in the configuration will result in an *unsaved changes* state.



Representation of an unsaved preset on the device.

Representation of an unsaved preset on the web remote.

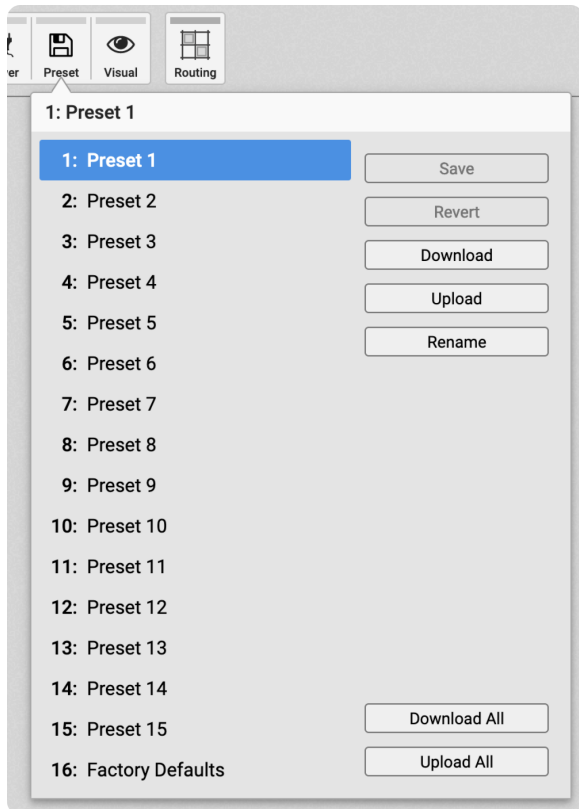

The internal preset storage is not affected when the device firmware is updated to a newer firmware version. Moreover, recalling the factory default preset does not delete any other saved preset.

Settings that are not saved in a Preset

The following settings are **not saved** in a preset:

- Auto-lock
- Lock code
- Remote control
- Device name

Quick Start Preset

Pressing and holding the first (top) button next to the display while powering on the 12Mic-D (and until the channel LEDs start flashing) activates the **Quick Start Preset**. Loading this preset does not affect any internally saved presets until it is saved.

The quick start preset is identical to the factory default preset, but it adds the following routings:

From analog input 1 - 12 to

- MADi Coaxial Ch. 1 - 12
- MADi SFP/Optical Ch. 1 - 12
- Dante® Ch. 1 - 12
- ADAT 1 Ch. 1 - 8
- ADAT 2 Ch. 1 - 4 (input 9 to 12)

7.1.1. Saving Presets

Up to 15 presets can be saved in the internal storage of the 12Mic-D.

To save a preset on the device:

1. Open the **preset** tab in the **STATE** section. The currently loaded preset is shown.
2. *(optional)* Rotate the encoder to choose a preset that should be overwritten.

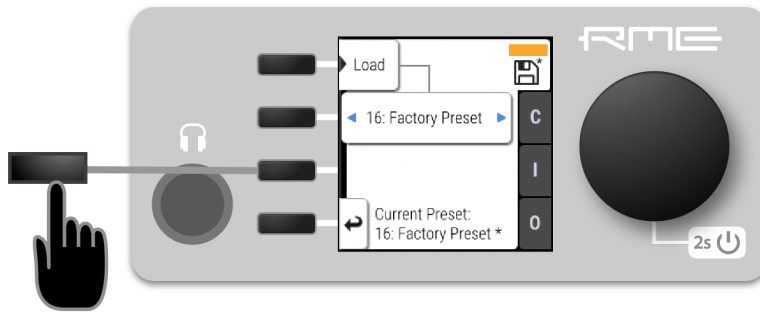

3. Push **Save** to save the preset.

To save a preset using the web remote:

1. Open the web remote and locate the **preset** tab.

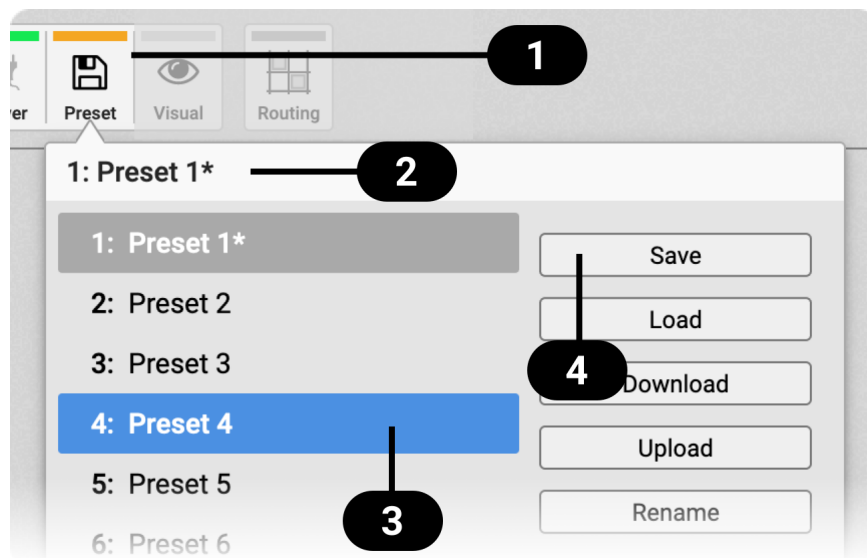

- 1 Status Indicator and tab
- 2 Current preset and state
- 3 Selected preset
- 4 Save preset

2. Click on a preset name in the left column **3** to select a preset.
3. Press the **Save** button **4**.

7.1.2. Loading Presets

Up to 15 custom presets can be loaded from the internal storage of the 12Mic-D.



Loading a preset cannot be undone. Ensure that any important configuration has been saved to another preset before proceeding.



The device name is part of the preset. When a preset is loaded, the device name is changed to the value stored in the preset.

To load a preset on the device:

1. Open the **preset** tab in the **STATE** section (see: *device control*).
2. Rotate the encoder to choose a preset.

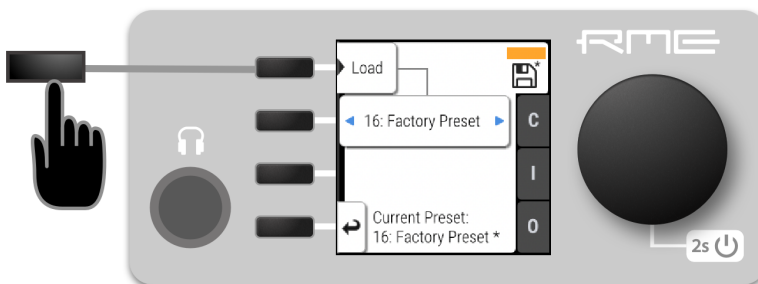

3. Select **Load** to load the preset.

To load a preset using the web remote:

1. Locate the **preset** tab
2. Use the drop-down menu **3** to select a preset.
3. Press the **Load** Button **4**.

7.1.3. Loading Factory Default Settings

The factory default settings are saved internally as **Factory Preset** and cannot be overwritten.

To load the factory defaults, load the 16th preset labelled **Factory Preset**.



Loading the factory defaults does not delete any saved presets. It also does not affect the **lock** settings in the **STATE** section.

7.2. Device Lock

The 12Mic-D can be secured against both accidental and intentional changes to its configuration. **Locking** the device, with or without code, protects against changes on the device itself. When locked, the display shows a lock symbol.

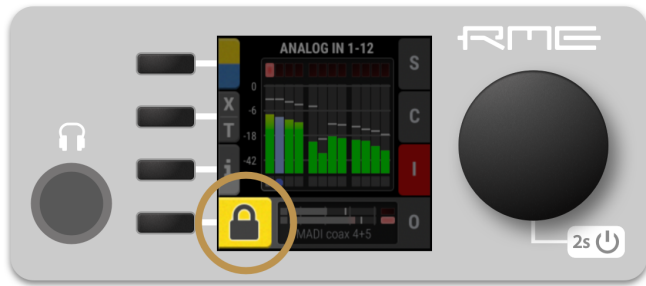

The device lock does not protect against changes via remote control. The lock configuration is not stored within a **preset**.



A four to six digit code can be configured on the device. If this code is lost or forgotten, it is not possible for the user to unlock the device. Contact your support for assistance.

7.2.1. Locking the Device

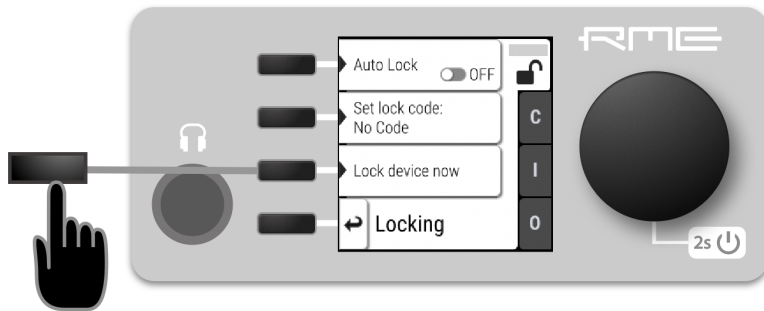

In order to lock the device, proceed with the following steps:

1. Open the **lock** tab in the **STATE** section (see *device control*).
2. (optional) **Set Code**: enter a four to six digit code with the encoder.
3. (optional) Activate the **Auto Lock** toggle to lock after one minute.
4. (optional) Select **Lock Device Now** to lock immediately.



Remember or write down the code shown in **SET CODE**. It is not possible to unlock the device without this code. A unique secondary code (PUK) can be obtained from RME Support upon request with a proof of purchase and device serial number.

To delete the code, move the cursor on the code and push the encoder. "No code" will be displayed.

The device can only be locked and unlocked at the front panel. These controls are not accessible remotely.

7.2.2. Unlocking the Device

To unlock the device **temporarily**:

1. Push and hold the encoder button for four seconds.
2. (if a code was set) Enter the code using the encoder and choose "Done".

The device will lock again after a timeout of one minute.

To unlock the device **permanently**:

1. Proceed as above, then
2. Open the **lock** tab in the **STATE** section
3. Deactivate the lock by toggling the switch to:  **OFF**
4. (optional) Move the encoder onto the lock code (if any), and push the encoder to delete it.

The device can only be locked and unlocked at the front panel. These controls are not accessible remotely.

7.3. Front Panel Illumination

The 12Mic-D front panel illumination reveals the current device state at a glance. It combines:

- full color LEDs at each input
- a standby indicator with integrated status warning
- a display with level meters and status feedback

Each of these three elements can be individually switched off (**dark mode**).

7.3.1. Dark Mode

Each of the three front panel illumination sections can be switched off if they are not required.

To turn off illumination on the device:

1. Open the **visual feedback** tab in the **STATE** section.

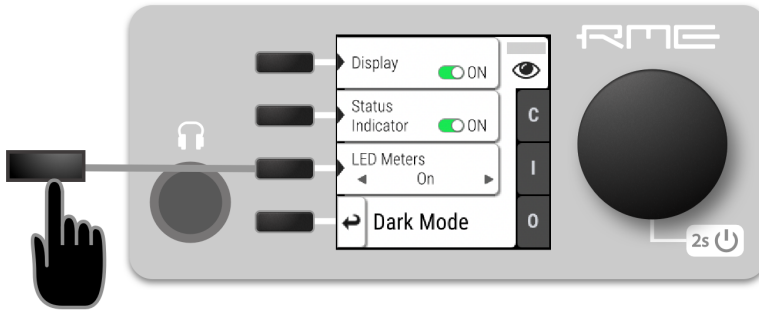

2. Change any of the following:

- a. **Display** to **off** to turn off the display.
- b. **Status indicator** to **off** to turn off the standby/status indicator .
- c. **LED Meters** to **off** or **Dimmed** to turn off or dim channel LEDs.



When any item is turned off, a notification (orange) is shown in the **STATE** section.

To turn panel illumination back on:

1. Open the same menu and set the corresponding switches to to **On**.



To turn the front panel lighting on temporarily, just rotate or push the encoder. The panel will turn back off after five seconds.

To turn off illumination on the web remote:

1. Connect to the device remotely (see: web remote).

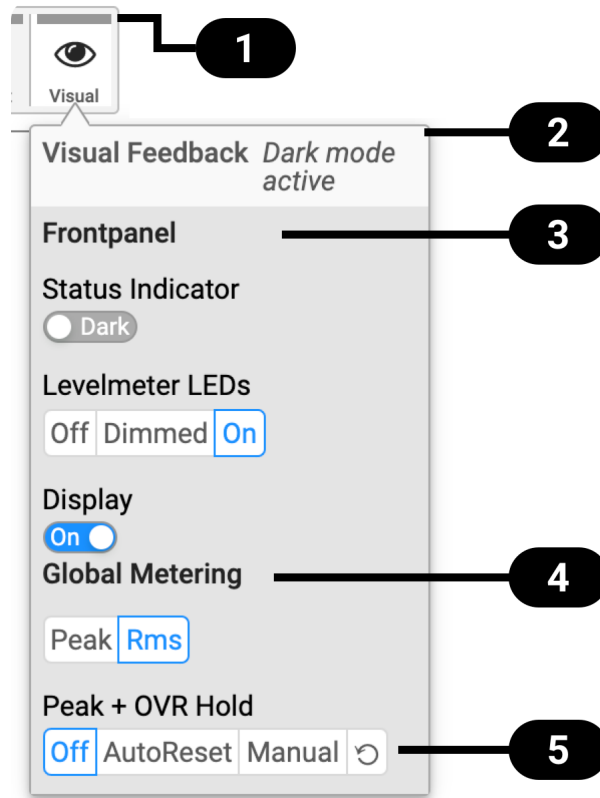

- 1 Status Indicator
- 2 State of Visual Feedback
- 3 Front Panel Dark Mode
- 4 Global Metering Options
- 5 Peak/Over Hold Reset

2. Use the corresponding toggle switches on the web remote to switch off device lighting.

7.3.2. Changing the Meters to Peak or RMS Mode

Depending on the application, instantaneous **peak level metering** or a slower, averaged **RMS metering** may be preferred.

To change the metering mode on the device:

1. Open the **visual feedback** tab in the **STATE** section.
2. Open "Global Meters" using the corresponding button.

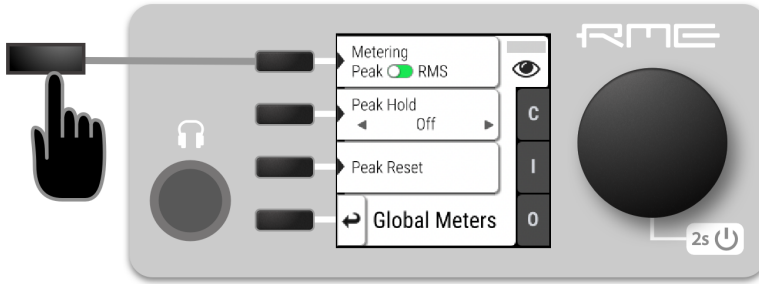

3. Press the first button to toggle between Peak and RMS metering.

To change the metering mode on the web remote:

1. Connect to the device remotely (see: web remote).
2. Locate the **visual feedback** tab in the **STATE** section.
3. Push the **Peak** or **RMS** button in the **global metering** settings.



This is a global setting which affects both the front panel level meters and the remote control interface.

7.3.3. Persistent Clipping Notifications and Peak Hold

The maximum level of signals can be saved and shown on the front panel and web remote. Clipping is detected when three consecutive samples reach digital full scale (0 dBFS). The duration of how long the maximum level or clipping is shown can be manually changed to either five seconds or until they are manually reset.



This is a global setting which affects both the remote control and the device.



On the device, an over notification is signaled as a fast flashing (red) of the channel LED.

To switch over notifications on or off:

1. Open the **visual feedback** tab in the **STATE** section

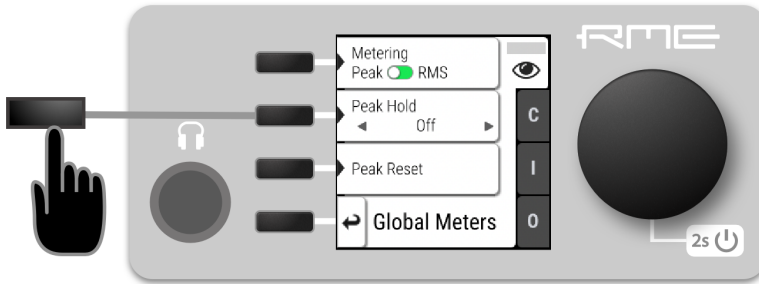

2. Change **Peak Hold** to either:
 - **5s** to notify for five seconds
 - **On** to notify until manually reset
 - **Off** to deactivate over notifications.

To reset infinite full scale notifications:

1. Open either the **INFO** menu from the standby screen or the **visual feedback - Global Meters** tab in the **STATE** section.

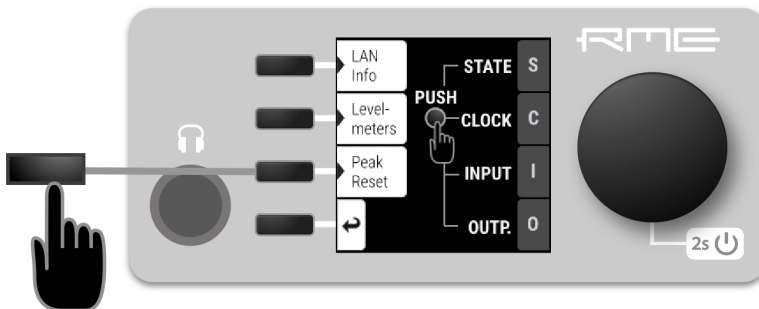

2. Push the **Peak Reset** button.



From the standby screen, press the third button twice to reset the over notifications on the device.



The remote shows an over notification above the level meter, both in miniature port level meters and the larger level meters when a port is open.

To switch persistent over notifications on or off:

1. Locate the Visual Settings Tab.
2. Change **Peak + OVR Hold** to either
 - **5s** to notify for five seconds
 - **On** to notify until manually reset
 - **Off** to deactivate over notifications

To reset over notifications:

1. Within the Visual Settings Tab, use the  reset button.

7.3.4. Metering of Digital Signals

The incoming and outgoing digital signals can be visually inspected to ensure that signals are properly connected and routed. Level meters are included for each port in the corresponding input and output sections, but they can also be inspected quickly from the main window without using the main menu:

To show the digital level meters on the display:

1. Open the info section (third button)  from the main screen.

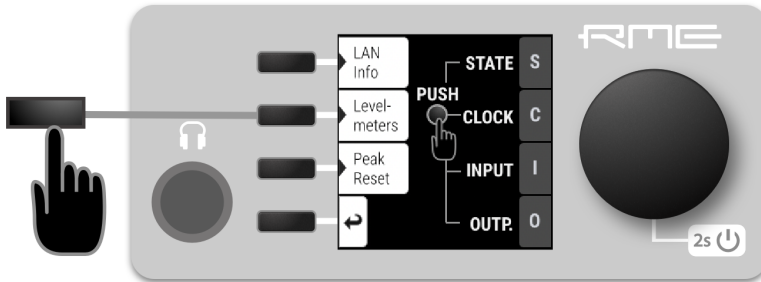

2. Open the tab "Levelmeters".

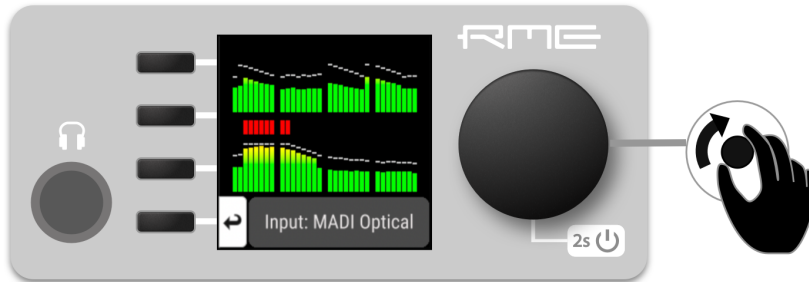

3. Turn the encoder knob to step through the input and output signals.

On the web remote, each input and output port has integrated level meters.

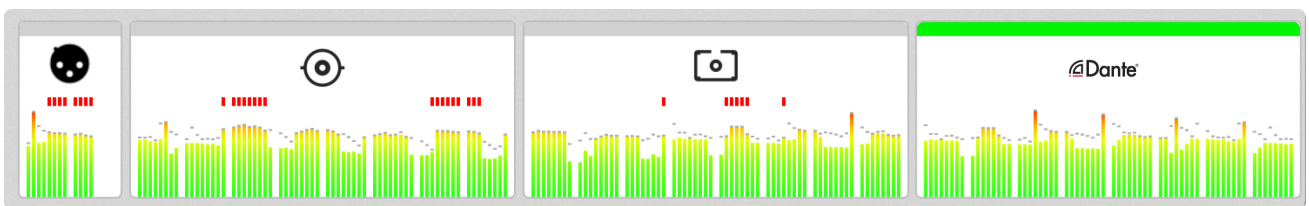

When opening the ports, larger levelmeters are shown with precise levels in dBFS RMS or peak.

7.4. Remote Control Overview

The 12Mic-D can be remote controlled. Remote control is activated by default and is not affected by preset changes or device lock.



The remote control protocols are not protected against malicious use. When activated, the remote control server allows anyone on the network to make changes to the configuration of the device. To limit access, secure the network that the device is connected to.

7.4.1. Finding the Device on a Network

The 12Mic-D has three integrated network adapters (USB 2.0 and dual ethernet).

The adapters can be used, individually or simultaneously, to control the device with HTTP ("web remote"). The web remote control works on any IP-based network, including wireless networks.

To enable web remote functionality over HTTP:

1. Open the **remote** tab in the **STATE** section. To enter the State section press the encoder twice while in the main screen, then select the remote tab.

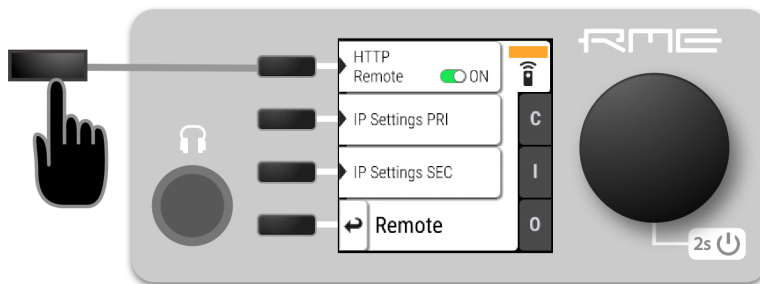

2. Ensure that the **HTTP Remote** setting is switched to **ON**.

USB

When the device is connected with a USB 2.0 cable to a Apple macOS™ or Microsoft Windows™ computer, a network device is automatically installed in the background that assigns the 12Mic-D the following IP address:

http://172.20.0.1



Only **one** of the following products can be connected to the host computer via USB at a time: RME M-32 AD Pro, M-32 DA Pro, 12Mic, 12Mic-D, AVB Tool, M-1610 Pro.

Ethernet

The integrated ethernet adapter will join an IP network when connected. If no DHCP server is found, for example when connecting the 12Mic-D directly to a computer, an address is automatically self-assigned (in the 169.254.0.0/16 subnet).

To find out the current IP address:

1. Open the **remote** tab in the **STATE** section. To enter the State section press the encoder twice while in the main screen, then select the remote tab.

2. The current IP address is displayed.
3. Enter the IP address in the address bar.

Connecting to the Remote Interface without IP address

Instead of using the IP address, the **device name** can be entered in the browser window, followed by **.local/**.

The current device name is shown on the **Info** ⇒ **LAN Info** screen and also in the main menu, STATE section, System Information.



By default, the device name is unique and can be seen in the Dante® Controller. A resulting URL will look similar to:

http://RME12Mic-d65432.local/



The device name can be changed with the Dante Controller. It is limited to 32 characters and must not begin or end with a hyphen ("-").



on some operating systems or browsers, a trailing dot "." may be required after the 'local' domain: <http://RME12Mic-d65432.local/>

7.4.2. Static IP Address

Both network ports of the 12Mic-D automatically retrieve an IP address if a DHCP server is present on the corresponding network. If there is no DHCP server on the network, a manual IP can be configured.

To manually assign an IP address to the device:

1. Open the **Remote** menu in the **STATE** section of the main menu.

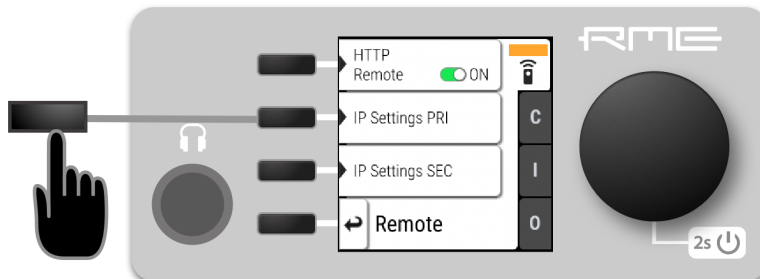

2. Select either the primary (**PRI**) or secondary (**SEC**) network, depending on which network should be configured.
3. Toggle **Mode**: to **Static** by pressing the first button.

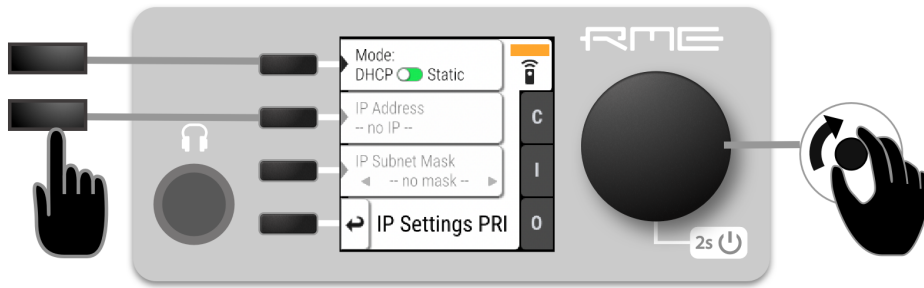

4. Press the second button to start entering an IP address. This is performed with the encoder, entering one decimal octet at a time, confirming each with an encoder press.
5. Press the third button to start entering the subnet mask. This is again performed and confirmed with the encoder.



When the 12Mic-D Redundancy Mode is configured to *Switch* in the Dante® Controller, the settings for the secondary network are ignored.

7.4.3. Web Remote

An integrated web server provides an easy-to-use remote control interface for the 12Mic-D. It requires a network connection from a desktop or tablet computer with a current browser version.



Due to the amount of features, the web remote manual has been separated from this manual. A link to download the current manual can be found on the RME website and in the **Settings** section of the web remote.

Compatible browsers:

- Chrome 98
- Safari 14
- Firefox 97
- Edge 98

or newer with support for WebGL.

Web Remote Overview



- 1 Section 2.2, "Firmware Update"
- 2 Section 5.1, "Identifying a Device Remotely"
- 3 Link to web manual
- 4 Section 7.6, "Power State"
- 5 Section 7.1, "Presets"
- 6 Section 7.3, "Front Panel Illumination"
- 7 Section 9.1, "Routing Signals to the Outputs"
- 8 Section 10, "CLOCK Section"
- 9 Section 8, "INPUT Section"
- 10 Section 8.1, "Analog Inputs"
- 11 Section 9, "OUTPUT Section"

7.4.4. JSON(OSC) Remote Control

This topic describes a method for remote control modeled loosely after the Sennheiser® Sound Control protocol. Detailed background information on the underlying technology can be found on the Sennheiser® website.

The 12Mic-D can be remote controlled with HTTP POST requests. Each request carries a data payload that contains a JSON object modeled after the open sound control (OSC) protocol.

For example, if the device is connected to a computer that can run *cURL* in a terminal application (Microsoft Windows™ PowerShell or Apple macOS™ Terminal), the following command will request the

entire device schema as a JSON object:

Request:

```
curl --header "Content-Type: application/json" --request POST --data
'{"osc":{"schema":null}}' RME12Mic-d65432.local/api/v2/self
```

Response:

```
{
  "osc": {
    "schema": {
      "osc": {
        "version": null,
        "schema": []
      },
      "device": {
        "entity_id": null,
        "entity_model_id": null,
        "entity_capabilities": null,
        "entity_name": null,
        "vendor_name": null, ①
        "model_name": null,
        "firmware_version": null,
        "group_name": null,
        [... continues]
```

① "vendor_name" Object

This schema can then be used to identify the possible parameters, for example the vendor name. Sending an empty value **null** triggers a response with the current value of the requested object.



The first two levels of the schema ({"osc": {"schema": {...}}) must be omitted. Only the encapsulated objects (**device, input, output, routing** etc.) are used.

To request the "vendor_name" object of the connected device, we run the following command. It is here outlined in more detail.

Request of vendor name:

```
curl \ ①
  --header "Content-Type: application/json" \ ②
  --request POST \ ③
  --data '{"device": {"vendor_name": null }}' \ ④
  RME12Mic-d65432.local/api/v2/self ⑤
```

① cURL command to send an HTTP POST request

② header: application/json

③ request type "POST"

④ JSON object sent to the device, 'null' to get current value

- ⑤ URL or IP of the device on the network with path to API

Executing this command delivers the expected result:

```
{"device":{"vendor_name":"RME Audio"}}
```



The entire web remote application is based on this protocol. It is therefore possible to read the data payloads sent to the device when interacting with the web remote by using the "Network"-tab of the developer tools inside the browser.

All device values must be polled by sending the corresponding JSON objects. It is possible to poll or set several values at once in a single object:

Set phase "on" for analog inputs 1-4

```
--data
{"input":{"analog":{"1":{"phase":true},"2":{"phase":true},"3":{"phase":true},"4":{"phase":true}}}}
```

7.4.5. JSON(OSC) Implementation Chart

The implementation chart is currently not included in this PDF. Please see the chart in the online version of this manual.

<https://docs.rme-audio.com>

7.5. Device Information

The **information** tab is located in the **STATE** section.

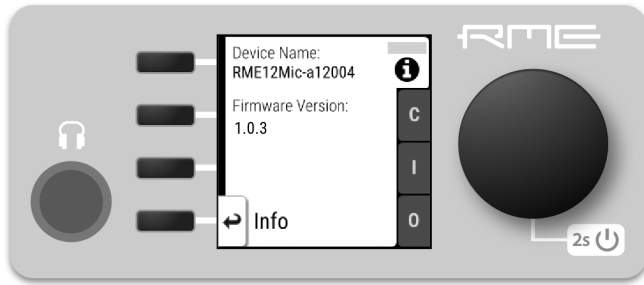

It shows the current device name and firmware version.

The information tab is only available on the device itself.

7.6. Power State



The power tab in the **STATE** section informs the user which of the two power inlets receive power. Its icon is a realtime representation of the current power state, with an inactive power supply shown in grey. The AC input corresponds to the left icon, the DC input to the right icon.

To check the current power state on the device:

1. Open the **power** tab in the **STATE** section

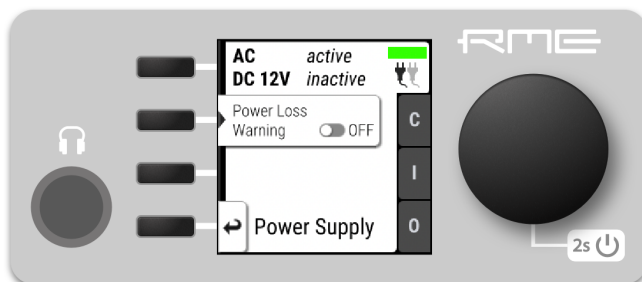

2. The state of each PSU is shown as *active* if it receives power.

To check the current power state:

1. Connect the device by USB or network cable and open the web remote.

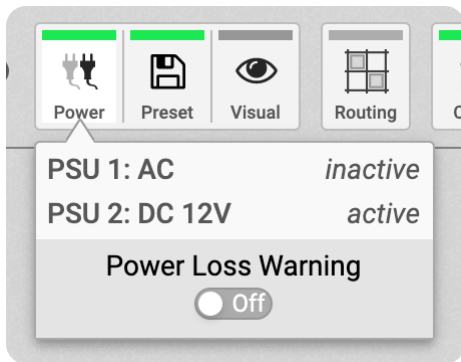

2. A click on the Power icon shows the current state of the power supplies.

7.6.1. Notification of Single Power Failure

A warning can be displayed when one of two connected power sources fails.

On the display, the "S" state indicator will turn red. In the main menu, a warning is signaled as an icon with a red bar:



Power loss at DC input

To activate the warning on the device:

1. Open the **power** tab in the **STATE** section.

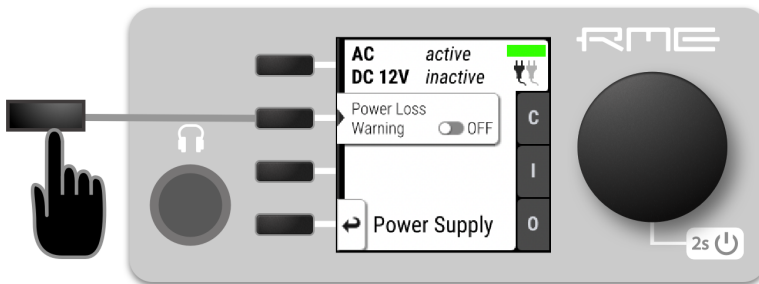

2. Toggle the switch **Redundancy** to **On**.



The warning signals only the current state.

To activate the warning on the web remote:

1. Connect the device by USB or network cable and open the web remote.

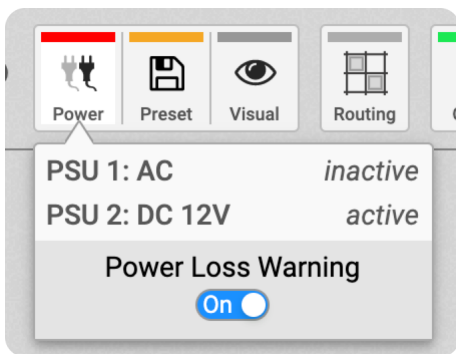

2. Toggle the "Power Loss Warning" to **On**.

8. INPUT Section

The input section is used to inspect and configure the audio inputs of the device. A warning is displayed when a digital input is not present but selected as clock master, or routed to an output and is either not present or not in sync to the clock master. Related input settings, such as MAD I auto input, can be configured here.

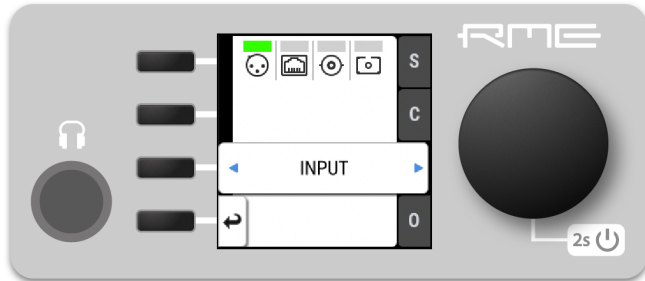

8.1. Analog Inputs

The analog inputs of the 12Mic-D can be configured at the device or remotely. Gain, AutoSet gain, phase, and phantom power (48V) can be set for individual inputs. In addition, the first four channels support toggling the input to TRS. While switched to TRS, the impedance can be set to High-Z for instrument signals.



Phantom power is only available at the XLR input, high impedance only at the TRS input. When toggling from TRS to XLR, the current High-Z setting is stored and recalled to its previous state when toggled back. The phantom power setting is **not** stored and will be switched off when toggling the channel to TRS.



To protect the input stage, only switch on phantom power **after** connecting a compatible condenser microphone or accessory. Remember to switch off phantom power when unplugging a microphone and before saving a preset.



The gain, AutoSet and phase settings are not affected when toggling between XLR and TRS inputs.

Latency and default routing

At single speed sample rates, the converters are configured with short delay 'sharp' IIR filters with extremely low latencies (5 samples) and flat frequency response over the entire audible range. At higher sample rates, a short delay 'slow' filter is used to additionally optimize the impulse response. The latency increases to six samples at quad speed (176.4 kHz, 192 kHz).

A new device has a user-writeable preset 1 with the following "quick start" routing. While the factory default preset (16) does not contain any routings, preset 1 is convenient for plug'n'play operation.



save preset 1 to any other preset for backup if it appears to be useful. It can be restored into temporary memory by pressing the first button next to the display while powering on.

The default setting in preset 1 routes the analog inputs 1-12 to:

- both MADI coaxial and optional MADI SFP (channel 1-12),
- Dante® channel 1-12
- ADAT port 1 (inputs 1-8) and port 2 (inputs 9-12)

8.1.1. Analog Input User Interfaces

Each analog input channel at the device has its own button. The button activates a settings dialog on the screen.

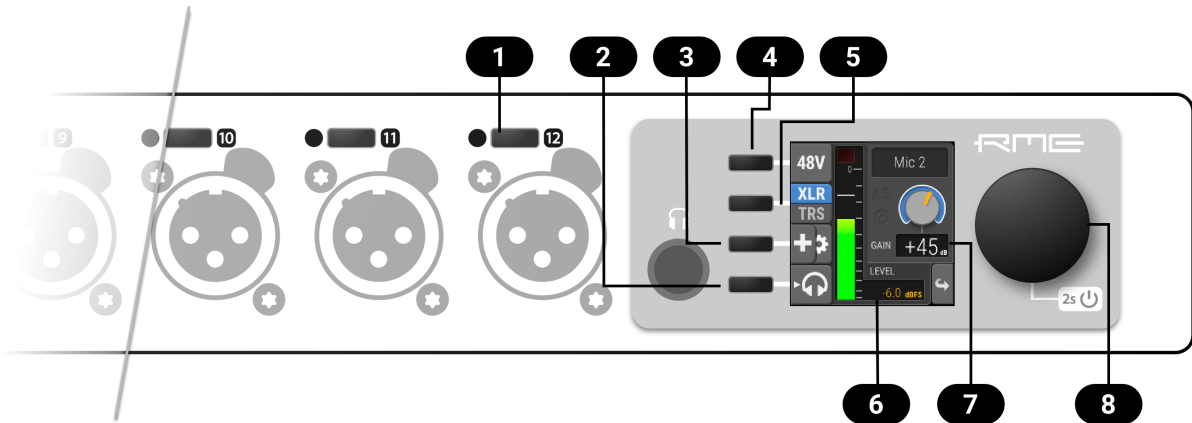

- 1** Activate channel controls
- 2** Monitor to phones
- 3** Gain Groups, Phase and AutoSet
- 4** Phantom Power
- 5** XLR/TRS Toggle
- 6** Current Input Level
- 7** Current Gain
- 8** Encoder

8.1.2. Adjusting the Input Gain

To adjust the input gain on the device:

1. Press the button next to the input. The current gain will be shown on the screen.



2. Rotate the encoder to adjust the gain.

[(211 3T 2)]

To adjust the input gain:

1. In the web remote, open the analog input port. Each input is represented with a channel strip.
2. Drag the **GAIN** knob vertically or horizontally.
 - Hold *SHIFT* to adjust in smaller increments (fine-adjust).
 - Double-click the knob to enter a specific value and confirm with *ENTER* or .

8.1.3. Enabling Phantom Power (P48)

Channels with active phantom power are shown on the standby-screen with a yellow square indicator.

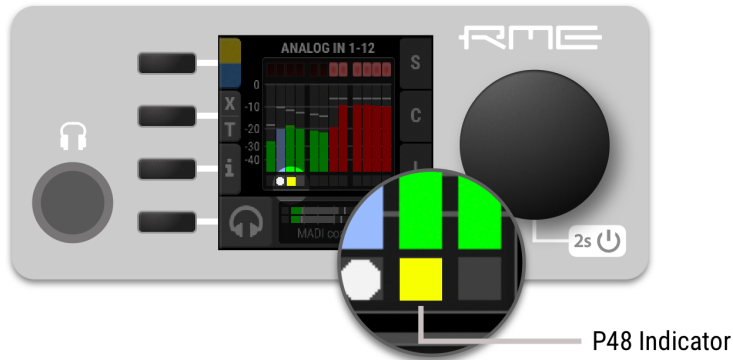

To activate phantom power on several channels:

1. While the standby screen shows the input level meters, press and hold the first button next to the yellow indicator. An instruction is shown on the display and the LEDs next to the input channels change to off (no phantom power) or yellow (phantom power active).

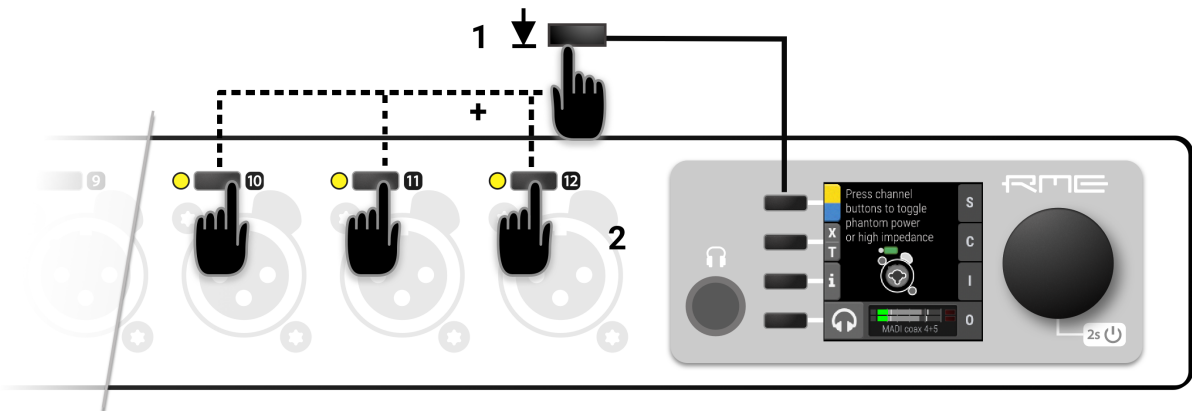

2. While holding down the button, press the channel buttons next to each input where the phantom power should be toggled on or off. A yellow LED at the input represents active phantom power.

To activate phantom power on a single channel:

1. Use the button next to the analog input to access its settings.



2. Use the P48 button to toggle phantom power.

To adjust the input line level on the web remote:

1. In the web remote, open the analog input port. Each input is represented with a channel strip.
2. Press the **48V** button in the corresponding channel strip.



Phantom power settings are not shown when the channel is switched to TRS input.

8.1.4. Switching Between XLR and TRS Inputs

The input channels 1-4 have "combo-jacks" that support both XLR and TRS connectors. When a plug is inserted, the corresponding input must be selected in the input settings. XLR is the default choice in the factory preset.



In order to prevent damage due to inrush current, the phantom power setting will be deactivated when toggling to TRS.

The current input mode is shown on the standby screen:

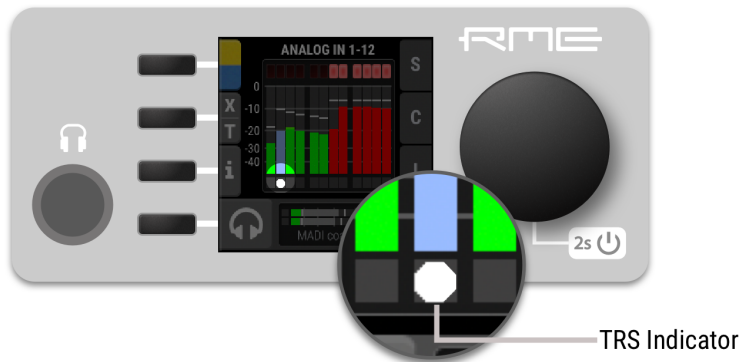

To toggle between XLR and TRS inputs on several channels:

1. While the standby screen shows the input level meters, press and hold the second button next to the X|T indicator. An instruction is shown on the display and the LEDs next to the input channels change to off (XLR) or white (TRS).

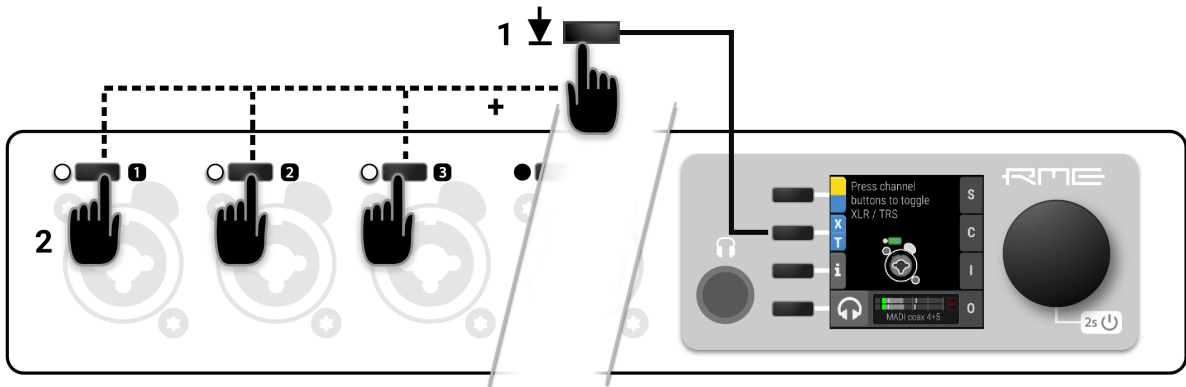

2. While holding down the button, press the channel buttons next to each input where the TRS input should be activated. A white LED at the input represents TRS.

To toggle XLR/TRS on a single channel:

1. Use the button next to the corresponding analog input to access its settings.



2. Use the **XLR|TRS** button to toggle the change the corresponding input. The active setting will be highlighted in blue.

To toggle XLR/TRS:

1. In the web remote, open the analog input port. Each input is represented with a channel strip.
2. Press the **XLR|TRS** button in the corresponding channel strips. The button highlights the currently selected value.

8.1.5. Activating High Impedance (Hi-Z) on TRS Inputs

A high input impedance can be activated manually for unbalanced TS connectors on inputs 1-4. The current input mode is shown on the standby screen:

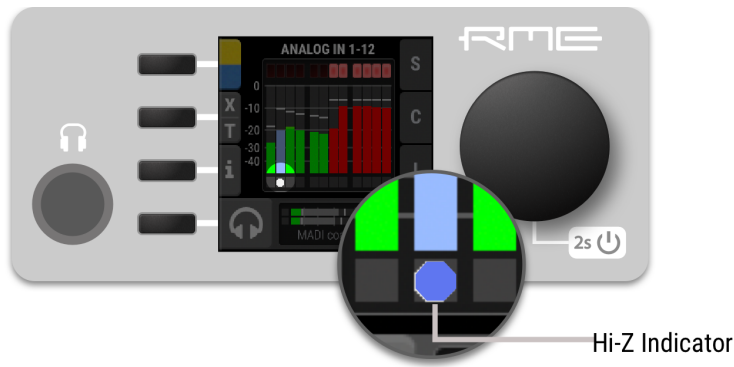

To activate high impedance on several channels:

1. While the standby screen shows the input level meters, press then hold down the first button. An instruction is shown on the display and the LEDs next to the TRS input channels change to white (low impedance) or blue (high impedance).

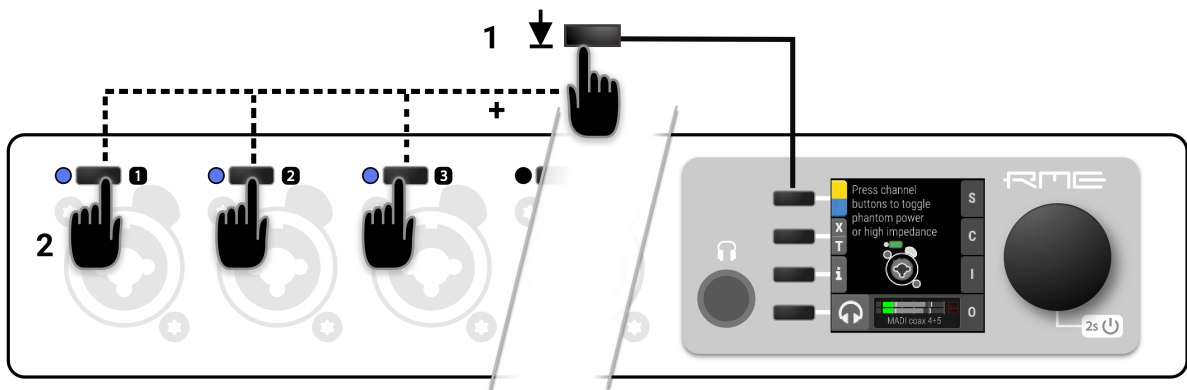

2. While holding down the button, press the channel buttons next to each TRS input where high impedance should be activated. A blue LED at the input represents high impedance.

To activate high impedance on a single TRS input channel:

1. Use the button next to the corresponding TRS input to access its settings.
2. Use the **Hi-Z** button to toggle high impedance. The active setting will be highlighted in blue.



To activate high impedance:

1. In the web remote, open the analog input port. Each input is represented with a channel strip.
2. Ensure that the TRS input is active (state of the **XLR|TRS** button).
3. Activate high impedance using the **Hi-Z** button in the relevant channel strips.



High impedance settings are not shown when the channel is switched to XLR input.

8.1.6. Inverting the Phase of an Analog Input Signal

The phase of analog input signals can be inverted at the input.





The setting persists even if the input source is toggled between XLR and TRS.

To toggle the phase of an input signal

1. Use the button next to the corresponding input to access its settings.



2. On a combined XLR/TRS input: press the *third* button twice in quick succession (double press).
3. On an XLR input: press the *second* button  once to access phase and AutoSet settings.
4. Press the *second* button  to invert the phase. It turns yellow when active.



5. Return to the input settings and verify that the \emptyset sign is shown next to the gain knob.

To invert phase of an analog input:

1. In the web remote, open the analog input port. Each input is represented with a channel strip.
2. Invert the phase using the  button in the corresponding channel strip.

8.1.7. AutoSet

AutoSet automatically reduces the gain when an input signal exceeds -6 dBFS. It can be set for each input channel individually. When using gain groups, AutoSet can be activated either for the entire group, or only for some channels. Only channels with activated AutoSet will be monitored to maintain the 6 dB headroom, but the resulting gain reduction will affect all channels of the gain group.



Gain offsets within a gain group are maintained as long as possible. If a participating channel reaches minimum gain, it remains at minimum gain while other channels continue to be reduced.

The AutoSet feature is very useful during sound checks or rehearsals. Simply set a very high gain and

activate AutoSet, then apply the loudest signals to be expected at the corresponding inputs. When signals exceed the -6 dBFS threshold, the gain is quickly attenuated.



While recording, AutoSet is usually switched off to avoid accidental gain reductions triggered by toggling phantom power, plugging in signals, etc.

8.1.8. Activating AutoSet

AutoSet can be adjusted in individual channels and gain groups.



The AutoSet setting persists even if the input source is toggled between XLR and TRS.

To activate or deactivate AutoSet of an input channel

1. Use the button next to the corresponding input to access its settings.



2. On a combined XLR/TRS input: press the *third* button twice in quick succession (double press).
3. On an XLR input: press the *second* button  once to access phase and AutoSet settings.

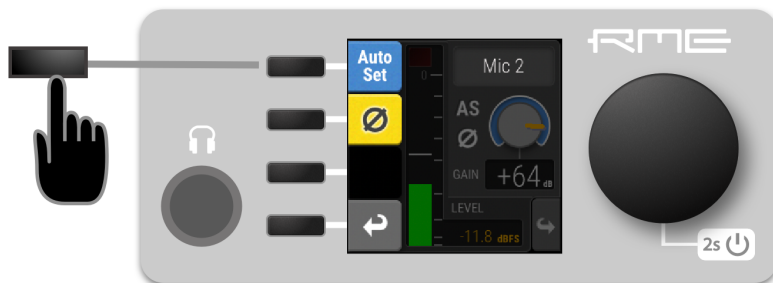

4. Press the *first* button **AutoSet** to activate AutoSet. It turns blue when active.
5. Return to the input settings and verify that the "AS" sign is shown next to the gain knob.

To activate or deactivate AutoSet of an entire gain group

1. Access the gain group or create a new one temporarily.
2. Press the *first* button **AutoSet** to activate AutoSet for all participating channels. Individual channels can be excluded from AutoSet threshold monitoring, in which case the **AutoSet** is shown half blue, half grey.

To activate or deactivate AutoSet of an input channel

1. In the web remote, open the analog input port. Each input is represented with a channel strip.
2. Use the **AutoSet** button in the corresponding channel strip.

To activate or deactivate AutoSet of an entire gain group

1. Open a gain group in the web remote.
2. Use the **AutoSet** button in the group panel appearing below the input channel strips. Individual channels can be excluded from AutoSet threshold monitoring, in which case the **AutoSet** is shown half blue, half grey.

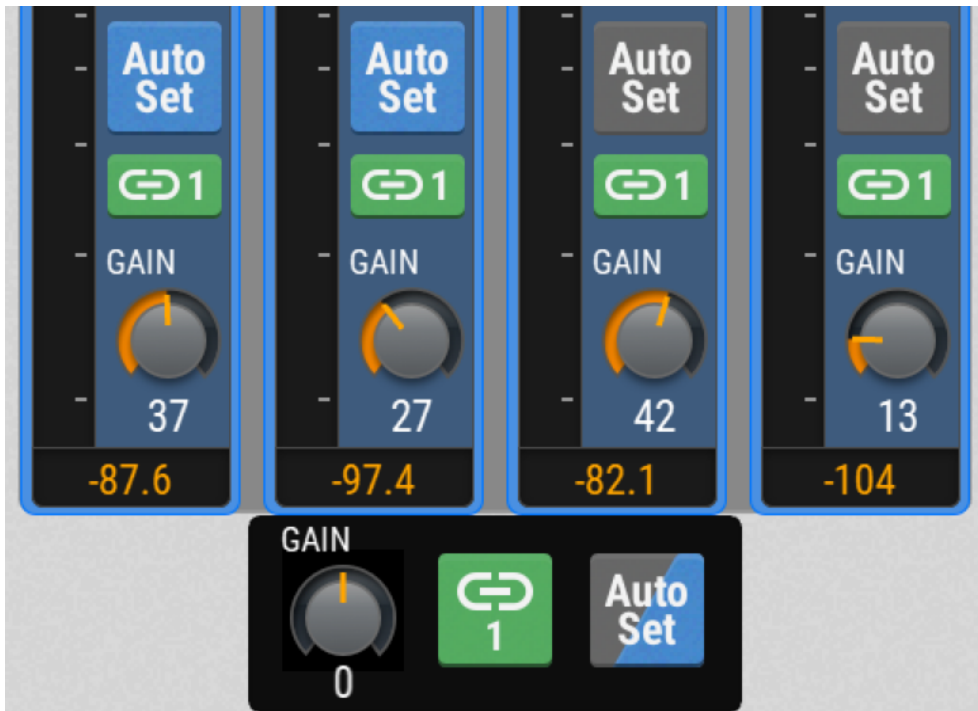

8.1.9. Gain Groups

The gain level of two or more channels can be linked temporarily or permanently. When part of a group, gain is increased or decreased as an *offset* (in dB) to the previously set individual gain levels. The offset is not stored itself - the adjustment is immediately applied to all member channels.

The group gain offset is **not** limited by the minimum/maximum gain of the participating channels. As a consequence, gain *differences* between channels will be reduced when a positive (negative) offset is applied while one of the channels has already reached its highest (lowest) gain setting.



In order to create an equal gain for all channels in a group, first set the offset of the group to its lowest (negative) value. Then, increase the offset to the preferred gain.

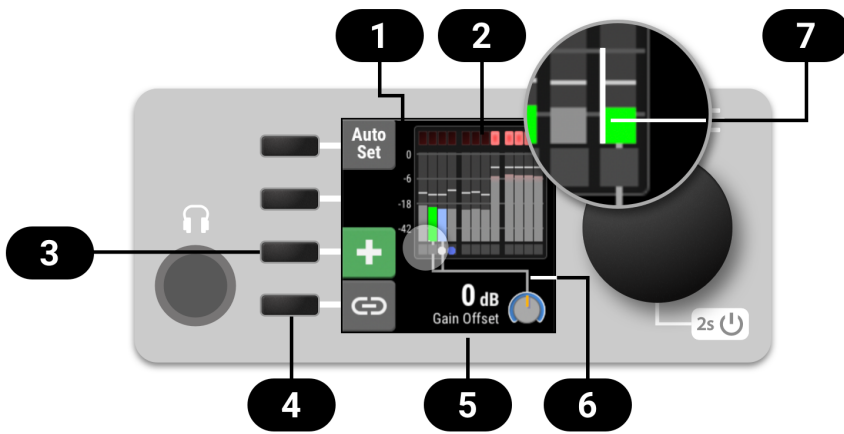

- 1 Group Overview
- 2 Level meters
- 3 Add channels to group
- 4 Save group
- 5 Current offset
- 6 Linked gains
- 7 Gain indicator



It is possible to adjust the gain of individual channels even when they are part of a gain group.

8.1.10. Creation and Use of a Gain Group

To create a group that controls the gain of two or more channels at once, proceed with the following steps:



the group can include TRS inputs that have a different gain range. Applied group gain offsets will be limited by gain range of individual channels.

When the device is idle (main screen):

1. Press and hold the first button at the first input. The channel is selected as the first channel in a group.

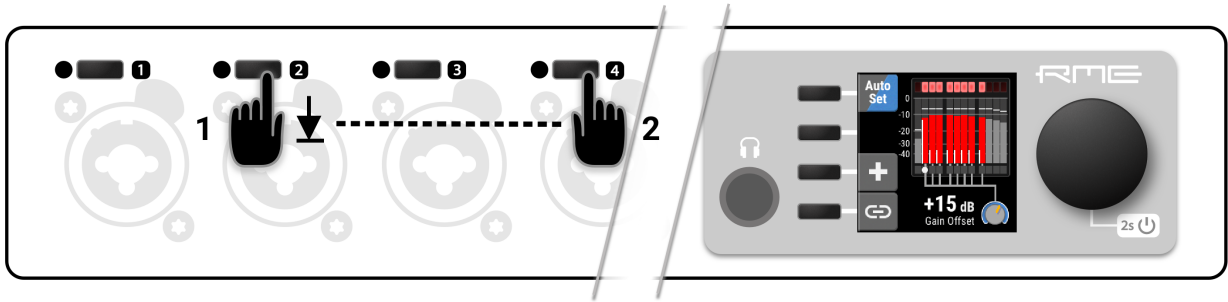

2. While holding down the first button, press a second button at another input. All inputs in-between will be added to the group. Release the buttons and adjust gain as required.



Channels that participate in the current group are shown with full color level meters and connecting lines to the encoder icon (refer picture above). Channels that do not participate in the group have grey level meters and are not connected.

3. Hold down the third button **+** and press input buttons to add or remove individual channels from the group.

When the first input channel is currently selected:

1. Press and hold the third button **+**. The button turns green and an instruction is shown.

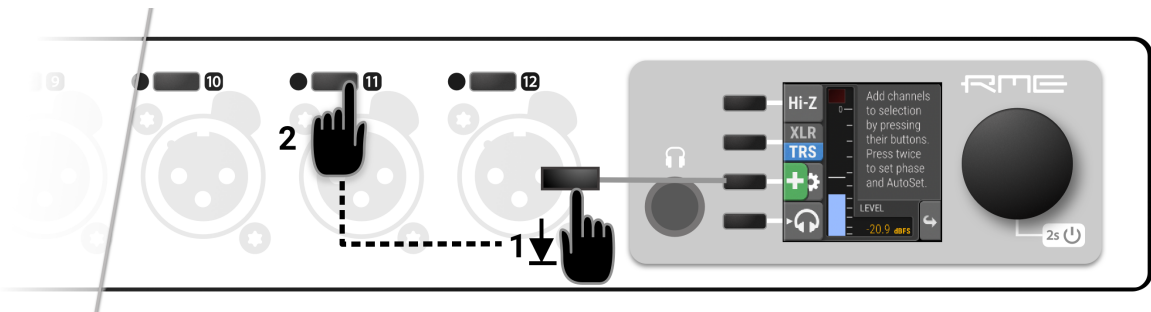

2. Press a second button at another input. The new gain group is displayed and allows adding further channels.

[[211 9T 3]] | {211-9T-3}

1. In the web remote, open the analog input port. Each input is represented with a channel strip. Note that each channel strip becomes highlighted when the cursor hovers over it.
2. Click or tap the first channel strip (avoiding the control buttons and encoder), and then swipe sideways to select a range of channels. The selected channels get highlighted in blue.
3. Click or tap on individual strips to add or remove them from the selection.
4. Use the additional gain knob floating below the selected channels to adjust the gain for all channels.

8.1.11. Saving, Using and Deleting Gain Groups

A temporary gain group can be saved.



Groups will be saved in presets and appear on both the device and its web interface. The gain of each channel remains fully independent.

To save the current gain group:

1. Create a temporary gain group. The selected channels will be shown on the screen, connected by a line attached to the bottom of their level meter.

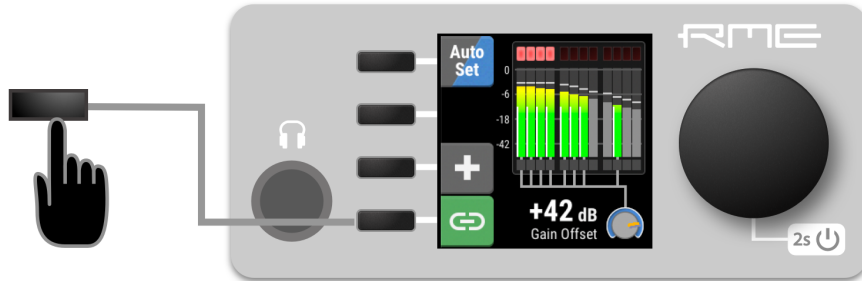

2. Press the fourth button next to the display. The "link" indicator turns green, indicating a saved group.



Groups will be saved in presets and appear always on both the device and its web interface. The gain of individual channels remains fully independent.

To access a previously saved gain group:

1. Press the input button of a participating channel. Instead of the individual channel settings, the group offset dialog will be shown. To continue to individual channel settings, press the input button one more time.

To delete a gain group:

1. Access a previously saved gain group.
2. Press and hold the **+** button and deselect any participating group channels.

To save the current gain group:

1. Create a temporary gain group. The selected channels will be highlighted in blue, with an additional floating gain control below.
2. Press the link button below the group. The "link" indicator turns green, indicating a saved group.

To access a gain group:

1. Each channel strip that participates in a gain group has an additional **Link** button with the number of the corresponding group. This button is used to select the gain group.

To delete a gain group:

1. Access a gain group.
2. Press the **Link** button with the current group number next to the group gain knob. The group is removed.

8.1.12. Monitor Analog Inputs at Phones Output

The phones output at the front of the 12Mic-D can receive any input signal. Permanent routings are configured in the Phones Output settings (see *Routing Signals to the Outputs* and *Section 9.2, "Analog*

Outputs"). Additionally, the analog **input** screens on the device provide a quick and convenient method to temporarily monitor analog input signals at the phones output.



when changing the routing, always ensure that the headphone volume is turned down to avoid damage to headphones and hearing.

To listen to an analog input on the phones output:

1. Ensure that the output volume is adequate (see Section 9.2.2, "Adjusting the Headphone Volume")
2. Press the button next to the corresponding channel to open the channel settings.



3. Use the fourth button to send this channel to the Phones Output (left and right) The button turns green, indicating that temporary routing has been established. The green button is also shown on the main screen and in the phones output settings.

To remove the temporary phones routing:

- Deactivate the routing by either pressing its button in the corresponding input channel, or
- by opening the phones output and deactivating the mode there. If there was a previous routing, it will be re-established immediately.

This function is only available on the device.

8.2. MADI Inputs

The 12Mic-D accepts up to two MADI signals, one electrical (BNC input) and one optical via SFP option (LC input).

To connect a MADI signal:

1. Ensure that you have set the correct sample rate and clock source in the **CLOCK** section.
2. Connect the cable to the corresponding input.
3. Open a **MADI** tab in the input section to see the current LOCK and SYNC state.

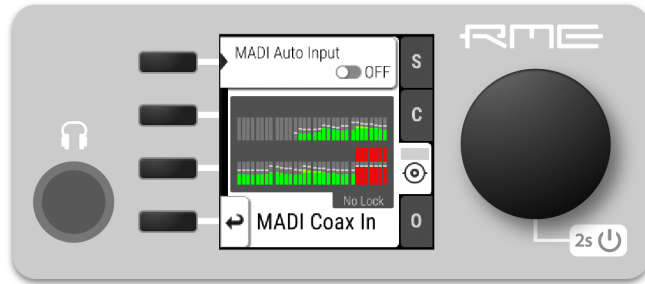

8.2.1. MADI at High Sample Rates

The MADI standard (AES10) allows transport of audio at sample rates beyond 48 kHz by reducing the number of available channels.

Double speed (88.2 kHz, 96 kHz)

Double speed audio signals can be transmitted and received in two different ways. Manufacturers can implement one or both modes, usually referred to as "96k frame" and "S/MUX 2" or "legacy" mode. It is important to use the same mode on both sender and receiver side because S/MUX 2 and legacy mode are not compatible. Both modes transport the audio signal transparently.

96k frame

The so-called "96k frame pattern" (AES10) can be detected at the receiver side automatically. In this mode, the frame numbers and corresponding user bits equal the number of channels submitted. The "56 Ch." setting corresponds to 28 audio channels at 88.2 kHz and 96 kHz sample rates. The "64 Ch." setting corresponds to 32 audio channels at 88.2 kHz and 96 kHz sample rates.

S/MUX 2

Sample multiplexing (or S/MUX 2) describes a method to distribute two consecutive samples onto neighboring channels. The MADI signal remains exactly the same as in single speed with 56 or 64 channels including its user-bits. The receiver decodes the audio signal by passing the samples of channel 1+2 as two consecutive samples for channel 1, samples of channel 3+4 as two consecutive samples for channel 2, and so forth. The amount of channels corresponds to the same as the 96k frame. This format cannot be automatically detected at the receiver side.

Quad Speed (176.4 kHz, 196 kHz)

Quad speed MADI does not have a standardized frame format. Therefore S/MUX 4 is used. The encoding works the same way as S/MUX 2, except that four consecutive channels are used to transport one audio channel. This reduces the available number of channels to 14 ("56 Ch." setting) or 16 ("64 Ch." setting).



When using MADI, the sample rate of the incoming MADI signal and the expected frame format of the outgoing MADI signal must be set in the device.

8.2.2. Connecting Two Identical MADI Signals for Redundancy

The coaxial MADI input can be configured to automatically switch to an existing MADI optical signal in case the coaxial signal fails. While existing routing and clock settings from the coaxial MADI input are kept, the port's name is changed to **MADI Auto Input** and its icon changes to reflect the feature. The

failover is seamless if the active input loses lock abruptly (e.g. one of the cables is unplugged).



The user is notified of the lost signal with a warning and redundancy can be re-established.



For a seamless failover, the two MADI signals must be identical. However, only the SYNC and LOCK states are evaluated to confirm the current input state. It is therefore possible to send two different signals to the 12Mic-D as long as they are in sync.

To create MADI redundancy:

1. Switch on "enable MADI redundancy" in the **coaxial** tab of the **INPUT** section. The port will be renamed to MADI Auto Input.

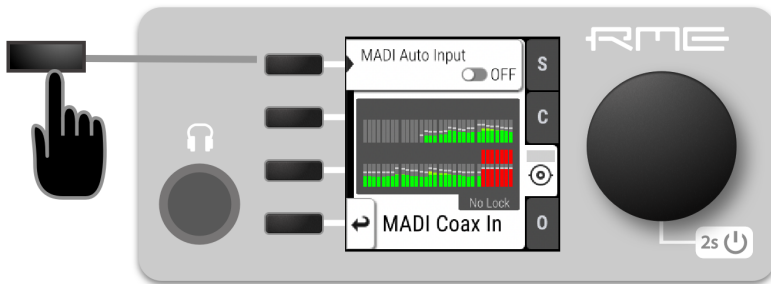

2. Create a routing from MADI Auto Input to any output.
3. If the device should also slave to MADI Auto Input, choose it as clock master in the **CLOCK** section.
4. Connect both MADI signals with identical audio.

To create MADI redundancy using the web remote:

1. Open the MADI Coaxial input port in the routing view.
2. Click the  icon that appears within the port.
3. Toggle the switch "Auto Input" to **ON**.

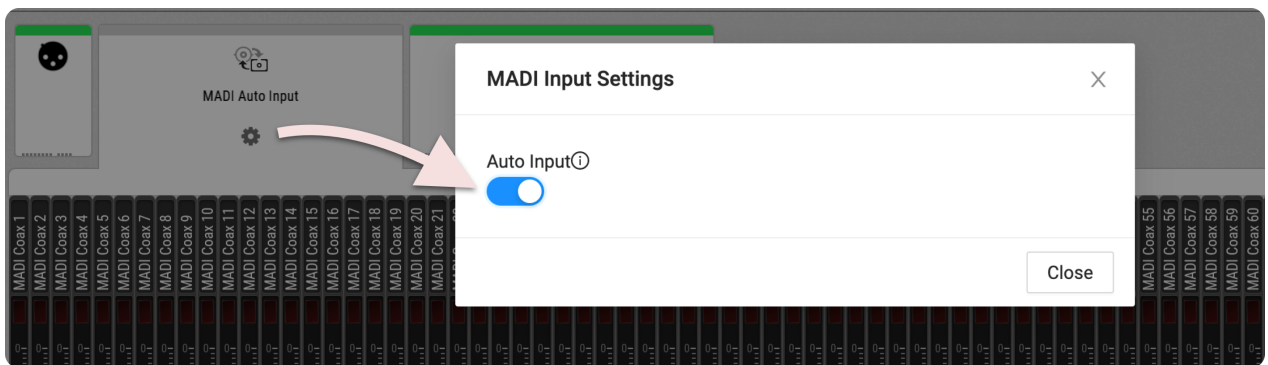

8.3. Dante Input

Connections to the 12Mic-D are created and inspected using the Dante® Controller. It can be downloaded as described here: [Dante Connectivity](#).

On the web remote, the Dante input is shown as an expandable tile with all incoming audio levels:

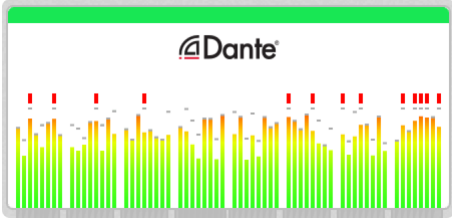

Routes from any incoming Dante channel can be internally connected to any output channel. The current routings are indicated as lines between inputs and outputs.

The signals that are received via Dante are shown within the input section:

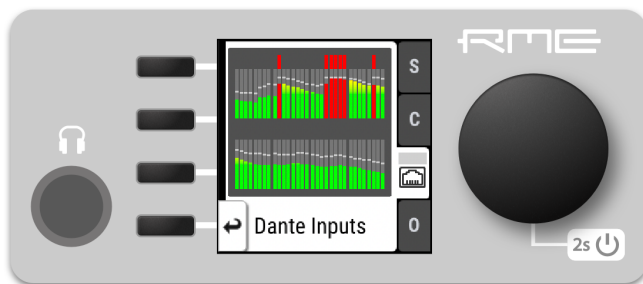

It is not possible to see where the signals are routed from the input section on the device. Routings are created and inspected within the output ports.

9. OUTPUT Section

The output section represents the internal routing matrix and state of the outputs. Routing is performed by selecting an output and assigning any input to it. When a routing is active, its input is automatically monitored for lock and sync in the input section.

Example:

In the **OUTPUT** section, **MADI Optical 1-12** is chosen as source for **Dante® channel 1-12**.

The 12Mic-D is clock master, but the incoming MADI signal is not correctly synchronized. This causes a warning in the **INPUT** section. If **MADI Optical** is not routed to any output, an invalid or missing signal does not cause a warning.



Use the web remote to find out quickly which outputs are receiving a specific input signal. The web remote provides a thorough representation of all active routing connections at a glance.

Device Output Section

Within the output section of the device, each output port has individual tabs for configuration and routing. The routing is shown per output channel, it is therefore necessary to browse through the channels to see the current routing.



Access the output section by pressing the encoder once from the main screen, and then rotate it to highlight OUTPUT. Confirm again with an encoder press.

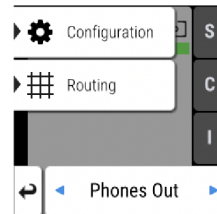
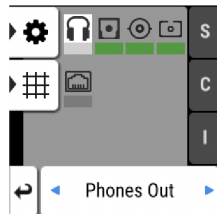
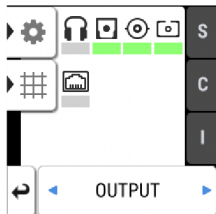

Web Remote Output Section

The web remote integrates the output ports with a visual routing interface. Output ports are shown as icons along the bottom of the screen, with visualized routings that point to the corresponding inputs. Each port can be opened to reveal its output levels, settings, and detailed routing.

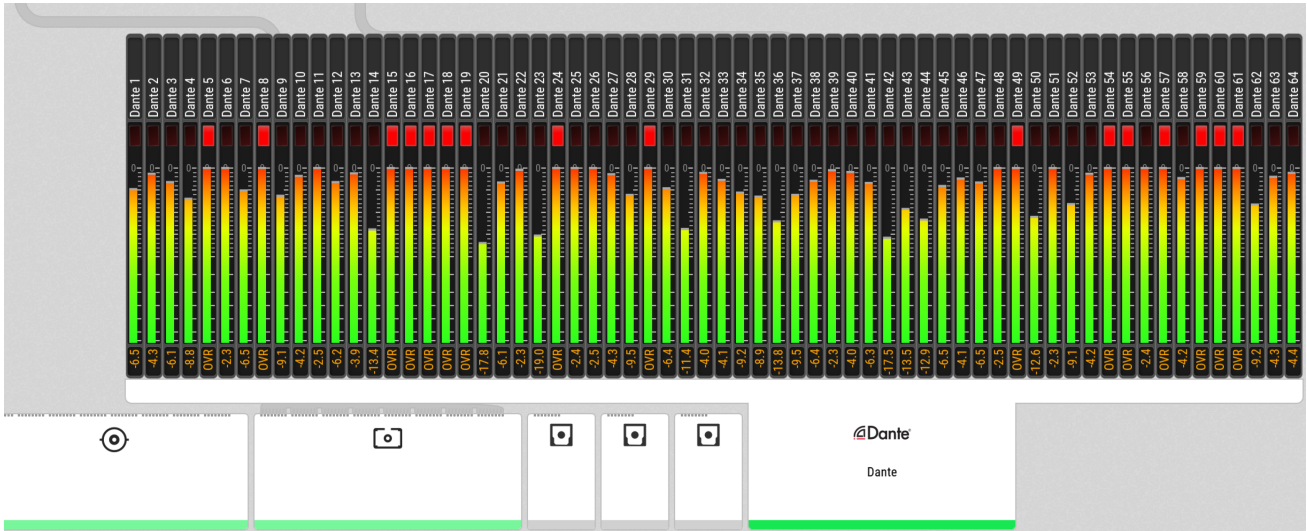

9.1. Routing Signals to the Outputs

Each output channel of the 12Mic-D can receive any input signal. If preset 1 has not been modified, it contains a routing of all analog inputs to all digital outputs. However, this can be adjusted and changed easily. The factory default preset does not contain any routing.



A routing immediately activates input monitoring for a corresponding digital input and raises a warning in the input state if the source signal is not available or out of sync.

The following example shows the procedure to route to MAD1 Coaxial output channels. Other outputs follow the same procedure.

To create a routing to a MADi Coaxial output:

1. Open the routing tab of the MADi Coaxial output in the **OUTPUT** section (see device control).

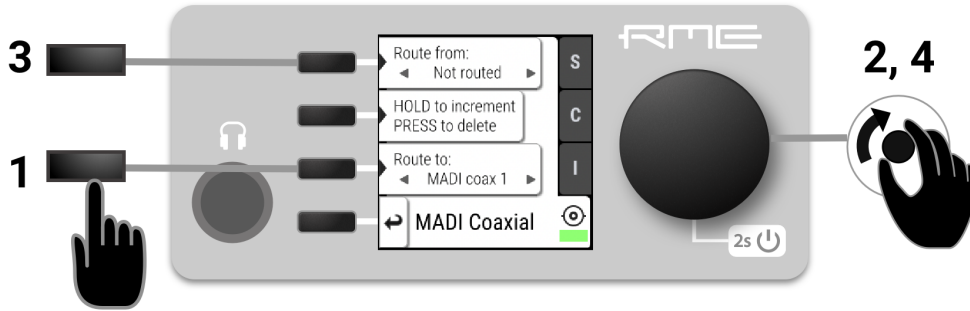

2. Activate the routing destination and choose an output channel with the encoder (steps 1 and 2).
3. Activate the routing source and choose an input channel with the encoder (steps 3 and 4).

To remove a routing:

1. Navigate to the corresponding output channel (1, 2).
2. Double click on "Increment routing". The routing source will be changed to "not routed".
3. (optional) Hold "increment routing" while turning the encoder to remove routings to the following output channels.

To route consecutive channels:

1. Navigate to the first output channel (1, 2) and create a routing as described above.
2. Hold "increment routing" while turning the encoder clockwise to increment input channel and output channel at the same time.

To create a routing to a MADi output on the web remote:

1. Enter the Routing mode by pressing the corresponding icon in the title bar.
2. Click the MADi coaxial or MADi optical output port.
3. Select individual or consecutive channels by clicking or dragging. The channels are highlighted in blue and an arrow handler is revealed.
4. If the input ports are closed, drag the handle onto an input port, it opens automatically.
5. Drag the handle onto the source channel strips to select a range of channels as signal source.

9.2. Analog Outputs

9.2.1. Phones Out



The front TRS connector can be used for phones or as a balanced mono output. Any incoming signal can be routed to the phones output. Analog input signals can be temporarily routed to the phones output while the original routing remains saved. A button on the standby screen gives access to all features of the output.



The analog output level meters show the routed input signal relative to 0 dBFS (pre gain) in grey color in the background, and additionally the calculated output level **post gain** in green color in the foreground.

9.2.2. Adjusting the Headphone Volume

The volume of the unbalanced phone outputs can be adjusted separately or as a stereo pair.

To adjust the headphone volume on the device:

1. While on the main screen, rotate the encoder. The current volume will be shown below the encoder on the screen.



To separate the left and right headphone channels:

1. Open the headphone configuration by clicking the phones icon on the main screen.
2. Open the additional settings  by pressing the encoder.



3. Press the "Stereo" button to separate the left and right channel. Each channel now has its own volume control which can be accessed by toggling the following button on the phones screen:



Follow the same procedure to join the two channels as a Stereo channel.

To adjust the phones output level:

1. Open the corresponding output channel strip.
2. Use the encoder to adjust the gain in the 'PHONES' channel strip.



Press the *Shift* key while dragging the knob for finer adjustments.



Clicking twice on the encoder knob opens a text field that can be used to input a value using the keyboard.

To separate the left and right headphone channels:

1. Press the Button labeled "Stereo". The button turns grey and a second channel strip opens with its own gain control.

Press the "Stereo" button again to create a stereo channel.



Any previously created gain offset between left and right channel will be ignored when joining the channels to a stereo group.

9.2.3. Muting the Phones Output

To mute the phones output:

1. While on the main screen, press the headphone button. The phones settings open.



2. Press the mute button. It turns red to symbolize that the phones are muted.



To mute the phones output using the web remote:

1. Press the mute button in the Phones output channel.

9.2.4. Using Phones Out as a Balanced Line Output

The headphone output can operate as a mono balanced line level output. This may for example be useful when an active talkback speaker with symmetrical input is connected to the 12Mic.

To activate balanced output mode on the device:

1. On the main screen, press the **PHONES** button to access phones output settings.
2. Press the encoder to open additional settings .



3. Press the **BAL** button to switch the channel to balanced out.

To toggle balanced output mode using the web remote:

1. Open the phones output channel.



2. Press the **BAL** button to switch the channel to balanced out. The channel that was routed to the left phones output will now be applied to both tip and ring of a TRS connector, the phase being inverted on the ring.

9.3. MADI Outputs

The MADI outputs of the 12Mic-D are always active. If no routing is configured, an empty stream is sent that can be used for clocking. The state without routing is represented with a light-green Status Indicator.

For instructions on how to create a routing to the MADI Output, see Section 9.1, "Routing Signals to the Outputs".

9.3.1. Setting the Output Channel Format and Frame Pattern

Depending on the requirements of the receiver, it is possible to change the channel format and frame pattern of the outgoing MADI streams.

To change the channel format of both MADI outputs on the device:

1. Go to one of the **MADI** tabs in the **OUTPUT** section.
2. Toggle the switch to **56Ch** or **64Ch** to adjust number of output channels.

To change the channel format of both MADI outputs using the web remote:

1. Open either MADI output port in the routing view.
2. Select the channel mode from the corresponding menu.



56Ch and 64Ch format correspond to 28/32 channels at double speed, and to 14/16 channels at quad speed.

To change the frame pattern of both MADI outputs on the device:

1. Go to one of the **MADI** tabs in the **OUTPUT** section.
2. Toggle the switch for 96k to use the 96k frame at 88.2 kHz and 96 kHz.

To change the frame pattern of both MADI outputs using the web remote:

1. Open either MADI output port in the routing view.
2. Select the frame format from the corresponding menu.



The 96k frame setting affects outgoing MADI signals at sample rates 88.2 kHz and 96 kHz. At other sample rates, the setting is not relevant and does not affect the outgoing signal.



It is not possible to select separate settings for each MADI port. Both ports will be affected regardless which output tab is used to change the setting.

9.3.2. MADI Daisy Chains

MADI is a uni-directional protocol with a fixed number of channels. When more than two MADI devices are connected, a serial connection is required. This is also referred to as a "daisy chain". The output of the first device is connected to the input of the second device, the output of the second device to the input of third device, and so on, until the signal is plugged into the input of the first device.

In a daisy chain, each device must be configured to pass on the *relevant* audio channels of its MADI input (the preceding devices) to the MADI output (the following device). Otherwise, each device would create a new MADI signal and not pass on audio from the devices that are connected to it.



While many RME devices pass on MADI signals automatically, the 12Mic-D must be explicitly configured to do so.

In order to pass on signals, configure the output routing of the required output port to pass on the signal from the MADI input port.



The latency of the MADI I/O is four samples.

9.3.3. MADI Port Mirroring

A redundant MADI connection protects from loss of audio in case of a single cable failure. To achieve redundancy, the receiver must support MADI redundancy. The sender must send two identical MADI signals on two outputs, usually the coaxial and optical ports.

The 12Mic-D features independent routing for both MADI output ports. For this reason, a "mirroring" of the signal must be manually created. In order to do this, the routing of the two MADI outputs should be configured to contain the same routing.



The receiving device usually ignores the audio contents of the two MADI signals. Therefore, the redundancy may appear to be set up even though the 12Mic-D sends different audio signals on both ports. Always ensure that the routing is correct for both output ports.

9.4. Dante Output

On the web remote, the Dante output is shown as an expandable tile with all outgoing audio levels:

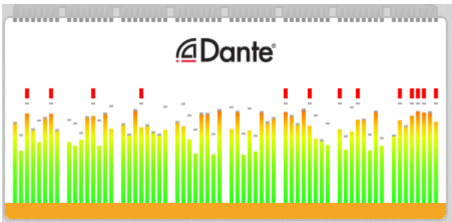

Signals from any incoming audio channel can be internally routed to the Dante output channels. The current routings are indicated as lines between inputs and outputs.

The signals that are transmitted via Dante can be selected and inspected in the output section:

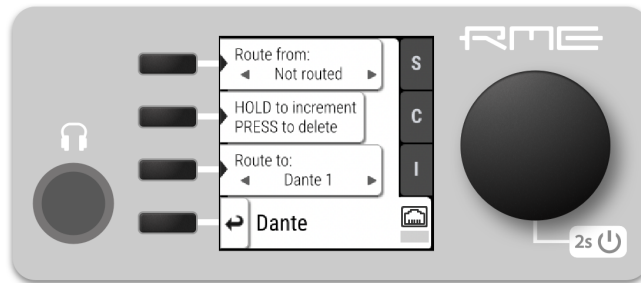

The method to create routings is described here: [Routing Signals to the Outputs](#)

There are no settings available or required in the Dante section. All further Dante configuration must be made in the Dante Controller.

9.5. ADAT Outputs

The ADAT outputs of the 12Mic-D are always active. On a new device, with preset 1 loaded and not modified, the analog input channels 1-8 are sent to ADAT port 1, and channels 9-12 are sent to ADAT port 2. The routing to ADAT outputs is saved per port. As a result, changing the sampling rate to double or quad speed temporarily hides the channels that cannot be transmitted for each output port, but restores their routing once the sampling rate is reduced in the clock settings.



At 44.1 and 48 kHz, a maximum of eight channels can be transmitted per port. This amount is reduced to four channels at 88.2 and 96 kHz (double speed), and to two channels at 176.4 and 192 kHz (quad speed) respectively.



there are no settings available or necessary for the ADAT outputs.

10. CLOCK Section

The **CLOCK** section is used to inspect and configure the clock source and sample rate of the 12Mic-D.

Web remote

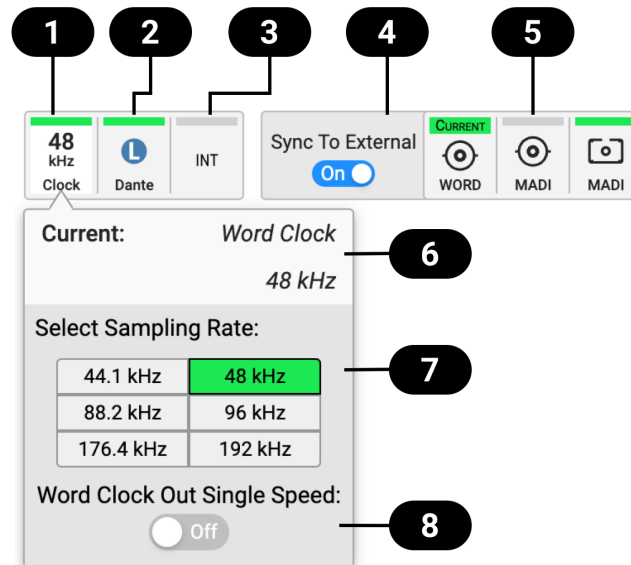

- 1 Clock Section
- 2 Selected Reference Clock
- 3 Status Indicator
- 4 Current Clock Reference and Rate
- 5 Sample Rate Selection
- 6 Word Clock Output Single Speed Setting
- 7 Set as Clock Reference

10.1. Clock Status

The clock of all digital inputs is continuously monitored with **SyncCheck™** and shown in the **CLOCK** section. A **warning (red)** occurs when the chosen clock source fails. A **caution (orange)** is displayed when a routed signal is out of sync. A **notice (light yellow)** is displayed when a signal is present/locked, but not in sync and not routed. A **good notice (light green)** is displayed when a signal is present and in sync, but not routed or chosen as clock source. A **good confirmation (green)** is shown when the signal is present and either chosen as source or routed and in sync.



A **warning** causes the CLOCK section to turn red, and the selected source generating the issue is displayed in the menu.

10.2. Leader Clock

In its default state, the 12Mic-D uses an internal reference clock for its audio signals. When connected to other Dante® devices, one device is elected the **Leader Clock**, and the other devices synchronize via network as **Followers**. This election takes place automatically and does not require any user interaction.

The current state can be observed in the Dante controller, the web remote and the device display:

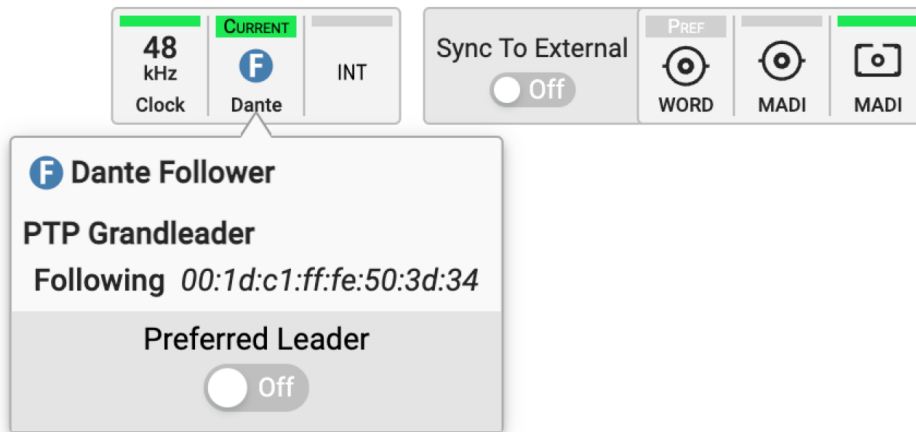
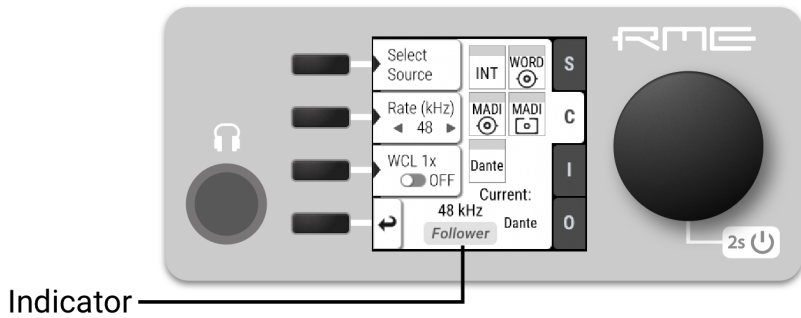

When receiving MADI signals from other devices, these signals must use the same reference clock as the 12Mic-D. This is usually achieved by connecting a MADI or Word Clock signal from the 12Mic-D to the other MADI device. The other device must then be configured to use that signal as a reference clock signal.

Alternatively, a device connected via MADI or Word Clock can be used as an external reference clock. This may be necessary when the configuration of the MADI device cannot be changed. The external clock must match the sample rate configured and the 12Mic-D must be clock leader.

10.2.1. Synchronizing to External

To configure the reference clock on the device:

1. Enter the **CLOCK** section (see device control).

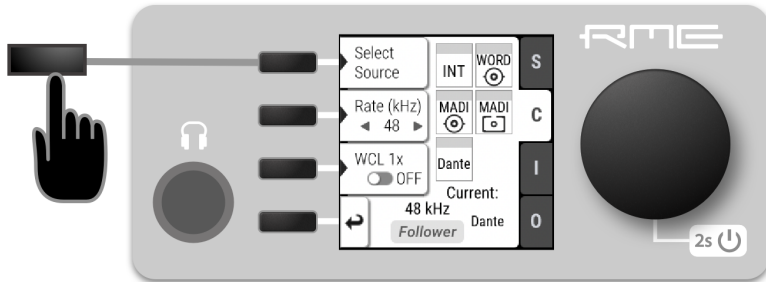

2. Push the first button: **Select Source**.

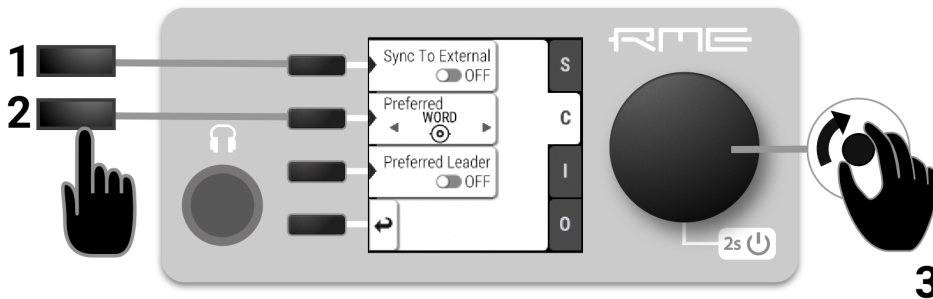

3. Rotate the encoder until the preferred clock source is shown.
4. Push the encoder again to activate the setting.

1. In the Clock panel, locate the button for the corresponding clock and click it.
2. Within the dropdown, press **Set as external clock preference**.

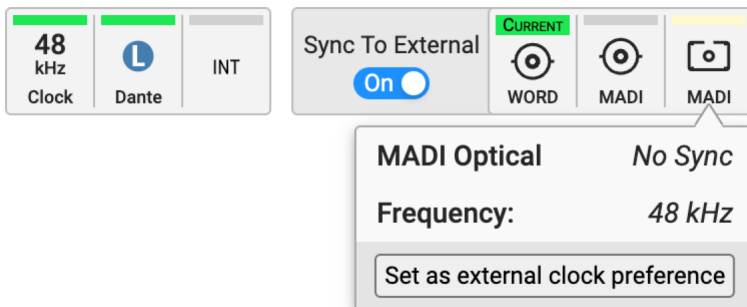

10.3. Sample Rates Overview

The 12Mic-D supports the following sample rates:

Supported sample rates

Single speed	44.1 kHz, 48 kHz
Double speed	88.2 kHz, 96 kHz
Quad speed	176.4 kHz, 192 kHz

10.3.1. Number of Channels

The supported number of channels per port at different sample rates is shown in the following table.

10.3.2. Number of Channels

The supported number of channels per port at different sample rates is shown in the following table.

Supported number of audio channels per port and direction at different sample rates

	44.1 kHz	48 kHz	88.2 kHz	96 kHz	176.4 kHz	192 kHz
Dante®	64	64	32	32	16	16
ADAT	8	8	4	4	2	2
MADI 56 Ch	56	56	28	28	14	14
MADI 64 Ch	64	64	32	32	16	16
MADI 56 Ch (96k frame)	---	---	28	28	---	---
MADI 64 Ch (96k frame)	---	---	32	32	---	---



Since there are two independent MADI ports, the total supported number of channels can be multiplied by two. The analog channel count remains identical at all sample rates.



The Dante channel count is based on a gigabit ethernet connection. Dante also support 100 MBit/s switches, however this will limit the above channel count to less than half. It is recommended to only use gigabit ethernet connections.

10.3.3. Selecting a Sample Rate

To configure the sample rate on the device:

1. Enter the **CLOCK** section (see device control).

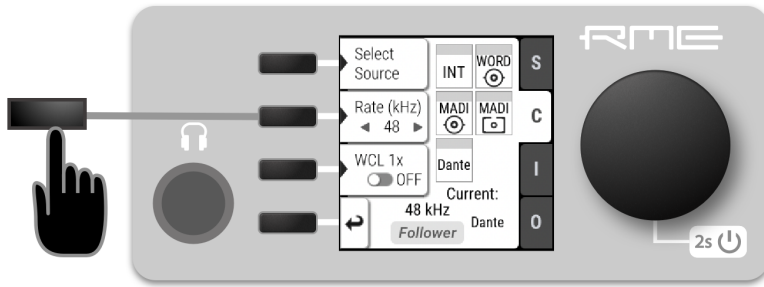

2. Use the button next to the current sample rate. Two blue arrows will appear to indicate that the encoder can now be used to change the rate.
3. Rotate the encoder until the preferred sample rate is shown.
4. Push the encoder again to activate the setting.

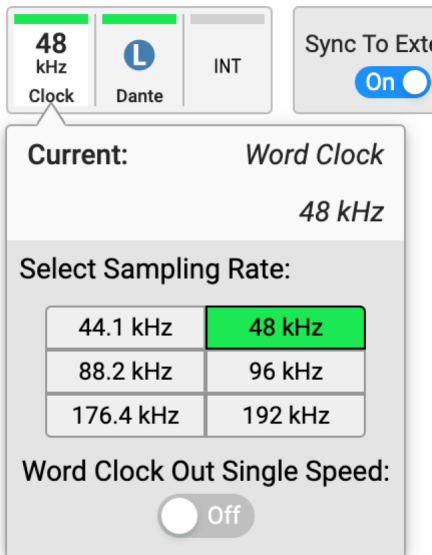

To configure the device sample rate on the web remote:

1. In the clock panel, click the first icon containing the current sampling rate.
2. Select the new sampling rate.

10.3.4. Effects of Sample Rate Changes on Existing Routing

The 12Mic-D saves one routing table per preset, regardless of sample rate. A change of sample rate or MADi frame mode can reduce the number of input and output channels available for routing. This does not alter the routing table. Any existing routing is hidden until another change of sample rate re-enables the channels.

Example:

A routing is created at 96 kHz with 32 channels, sending the MADi coaxial Input 1-32 to optical MADi Output 1-32. If the sample rate is now changed to 176.4 kHz and the 56 Ch frame is activated, only the

first 14 channels of MADI coaxial input are routed to the optical output. Switching the sample rate to 44.1 or 48 kHz will reveal the previous routing for 32 channels.

10.4. Set Word Clock Output to Single Speed

At sample rates > 48 kHz, it may be necessary to synchronize two devices with a fraction of the actual sample rate:

Sample Rate	Word Clock Full Speed (default)	Word Clock Single Speed (option)
88.2 kHz	88.2 kHz	44.1 kHz
96 kHz	96 kHz	48 kHz
176.4 kHz	176.4 kHz	44.1 kHz
192 kHz	192 kHz	48 kHz

To set the Word Clock output to single speed on the device:

1. Open the **CLOCK** section (see device control).

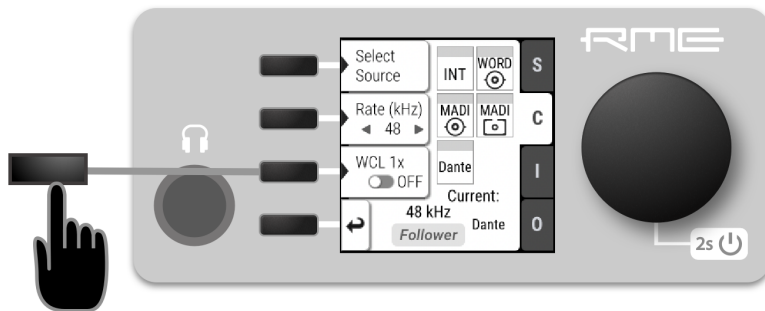

2. Use the third button to toggle **WCL 1x**.

To set the Word Clock output to single speed on the web remote:

1. Locate the **CLOCK** section.
2. Move the cursor onto the **Word Out Single** switch and push the encoder to change the value.

11. Annex

Trademarks and Copyright

All trademarks, registered or otherwise, are the property of their respective owners.

RME is a registered trademark of RME Intelligent Audio Solutions.

SyncCheck, SteadyClock, ICC, Intelligent Clock Control and Digiface are trademarks of RME Intelligent Audio Solutions.

Microsoft, Windows, Windows 7/8/10 are registered trademarks of Microsoft Corp.

Apple and macOS are registered trademarks of Apple Inc.

Dante® is a registered trademark of Audinate Pty Ltd.

Copyright © 2022 m2lab Ltd.



This manual is licensed under a Creative Commons Attribution-NonCommercial-NoDerivatives 4.0 International License [<http://creativecommons.org/licenses/by-nc-nd/4.0/>].

Glossary

96k frame

MADI sources with a sample rate of 88.2kHz or 96kHz can be configured to use the so-called **96k frame**. If this frame is used, a sample rate of 88.2 or 96 kHz can be detected on the receiver side automatically. When it is not used, or when higher sample rates are used, the receiver must always be configured to the correct factor (x2, x4) since there is no other mechanism in MADI that allows automatic detection.

Double speed

A sampling rate of 88.2 kHz or 96 kHz (compare single speed and quad speed)

DHCP server

A DHCP Server hands out IP addresses to network devices. Every consumer oriented WiFi Router has a default DHCP Server handing out private addresses, usually 192.168.0.x. The IP address of a network device must be known in order to communicate with it on Layer 3.

MADI

Multichannel Digital Audio Interface as defined in the AES 10 standard. Used to receive and transmit up to 64 uncompressed audio channels over coaxial or fibre optic connection.

Quad speed

A sampling rate of 176.4 or 192 kHz (compare single speed and double speed).

Single speed

A sampling rate of 44.1 kHz or 48 kHz (compare double speed and quad speed).

Word Clock

An electrical square wave signal transported over coaxial 75 Ohm terminated cables. It is used to synchronize the receiving device (slave, word clock input) to the sending device (master, word clock output).

11.1. Regulatory Compliance

11.1.1. CE Compliance

This device has been tested and found to comply with the limits of the European Council Directive on the approximation of the laws of the member states relating to electromagnetic compatibility according to RL2014/30/EU, and European Low Voltage Directive RL2014/35/EU.

11.1.2. FCC Compliance

This device complies with Part 15 of the FCC Rules. Operation is subject to the following two conditions: (1) this device may not cause harmful interference, and (2) this device must accept any interference received, including interference that may cause undesired operation.

WARNING: Changes or modifications to this unit not expressly approved by the party responsible for compliance could void the user's authority to operate the equipment.

NOTE: This equipment has been tested and found to comply with the limits for a Class B digital device, pursuant to Part 15 of the FCC Rules. These limits are designed to provide reasonable protection against harmful interference in a residential installation. This equipment generates, uses and can radiate radio

frequency energy and, if not installed and used in accordance with the instructions, may cause harmful interference to radio communications. However, there is no guarantee that interference will not occur in a particular installation. If this equipment does cause harmful interference to radio or television reception, which can be determined by turning the equipment off and on, the user is encouraged to try to correct the interference by one or more of the following measures:

- Reorient or relocate the receiving antenna.
- Increase the separation between the equipment and receiver.
- Connect the equipment into an outlet on a circuit different from that to which the receiver is connected.
- Consult the dealer or an experienced radio/TV technician for help.

Shielded cables must be used with this unit to ensure compliance with the Class B FCC limits.

Responsible Party in USA: Synthax United States, 6600 NW 16th Street, Suite 10, Ft Lauderdale, FL 33313
T.:754.206.4220

Trade Name: RME, Model Number: 12Mic

11.1.3. Note on Disposal

According to the guide line RL2002/96/EG (WEEE – Directive on Waste Electrical and Electronic Equipment), valid for all european countries, this product has to be recycled at the end of its lifetime. In case a disposal of electronic waste is not possible, the recycling can also be done by Scheck Audio GmbH, the manufacturer of this device.

For this the device has to be sent free to the door to:

Scheck Audio GmbH, 3. Industriestr. 5, 68804 Altlussheim, Germany.

Shipments not prepaid will be rejected and returned on the original sender's costs.