

VISBY V  
8141/2000/8300  
8100/2500/8142

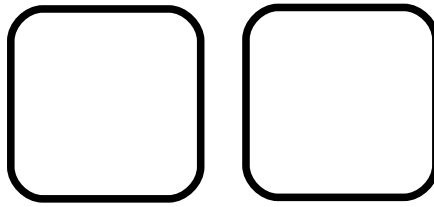

210410

- |           |  |           |   |
|-----------|--|-----------|---|
| <b>D</b>  | MONTAGEANLEITUNG<br>BEDIENUNGSANLEITUNG                | <b>GB</b> | ASSEMBLY INSTRUCTIONS<br>INSTRUCTION MANUAL         |
| <b>NL</b> | HANDLEIDING VOOR DE MONTAGE<br>GEBRUIKSAANWIJZING      | <b>PL</b> | INSTRUKCJA MONTAŻU<br>INSTRUKCJA OBSŁUGI            |
| <b>TR</b> | MONTAJ TALIMATI<br>KULLANIM KLAVUZU                    | <b>RU</b> | ИНСТРУКЦИЯ ПО МОНТАЖУ<br>ИНСТРУКЦИЯ ПО ЭКСПЛУАТАЦИИ |
| <b>RO</b> | INSTRUCȚIUNI DE INSTALARE<br>INSTRUCȚIUNI DE UTILIZARE | <b>IT</b> | ISTRUZIONI DI MONTAGGIO<br>MANUALE DI ISTRUZIONI    |
| <b>FR</b> | NOTICE DE MONTAGE<br>MANUEL INSTRUCTIONS               | <b>SK</b> | MONTÁŽNY NÁVOD<br>NÁVOD NA POUŽITIE                 |
| <b>HU</b> | KÖZGYŰLÉS UTASÍTÁSOK<br>KEZELÉSI UTASÍTÁS              | <b>CZ</b> | MONTÁŽNÍ NÁVOD<br>NÁVOD K POUŽITÍ                   |
| <b>SI</b> | NAVODILA ZA MONTAŽO<br>NAVODILA ZA UPORABO             | <b>PT</b> | INSTRUÇÕES DE MONTAGEM<br>MANUAL DO USUÁRIO         |
| <b>ES</b> | INSTRUCCIONES DE MONTAJE<br>MANUAL DEL USUARIO         | <b>HR</b> | UPUTE ZA MONTAŽU<br>UPUTE ZA UPOTREBU               |



0019

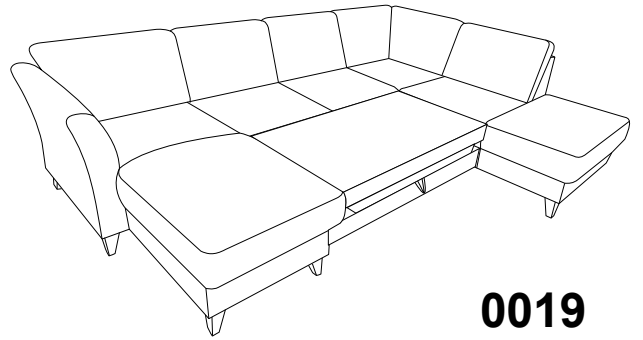
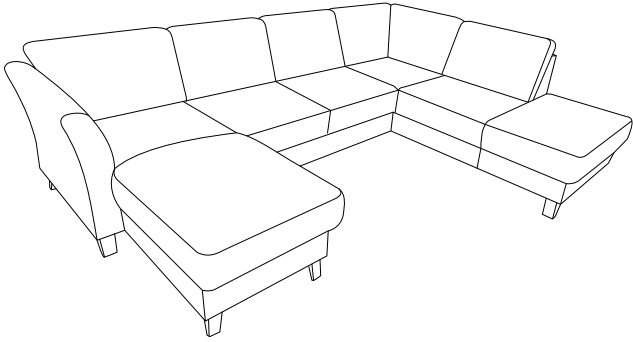

0019

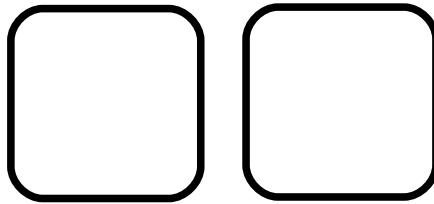
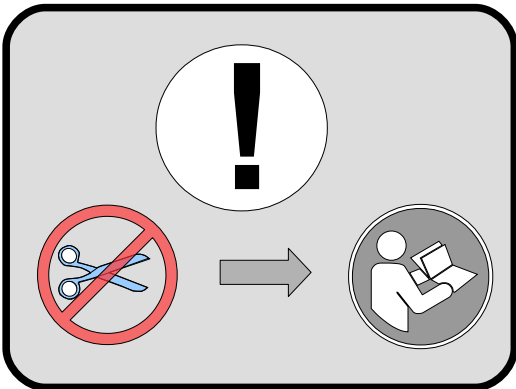

0089

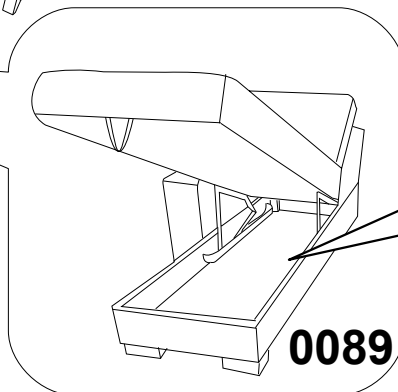
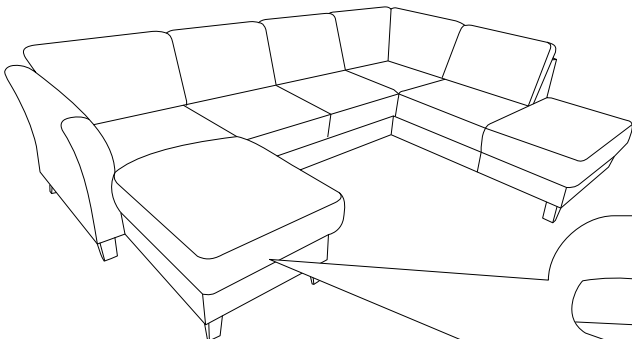

0089



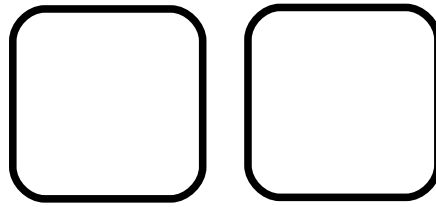

0088

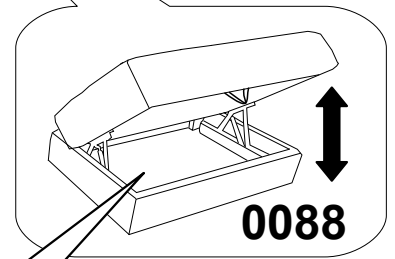
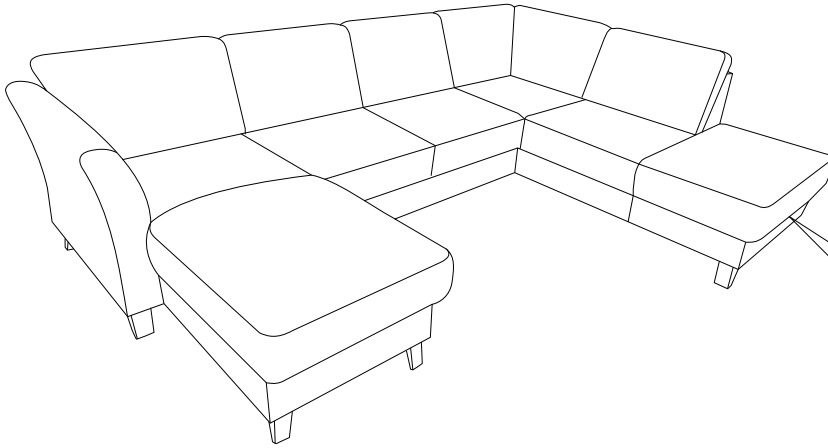



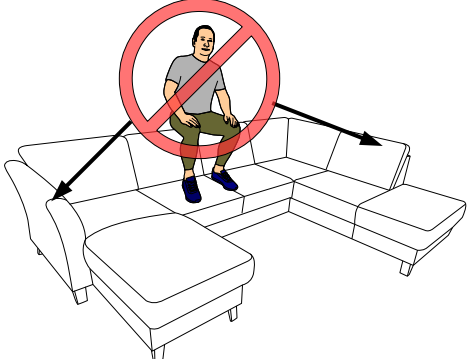

R

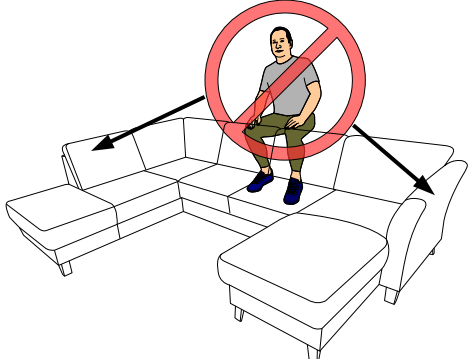





L

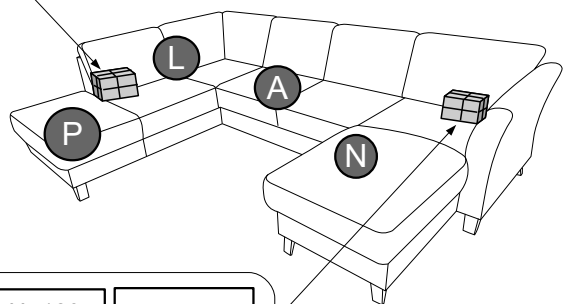
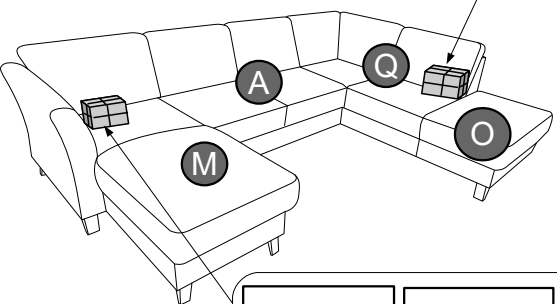





<b>Z</b> H-120  X3	<b>V</b> H-120  X1	<b>i</b> L-5  X1	<b>S</b> H-120  <b>S<sub>1</sub></b> X3	<b>q</b> M8*20 [mm]  X3
---	---	---	---	--

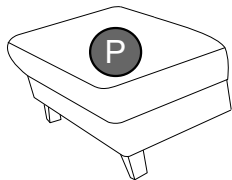
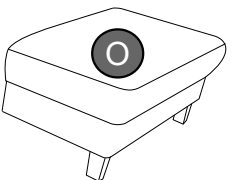
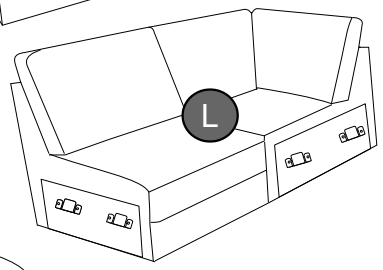
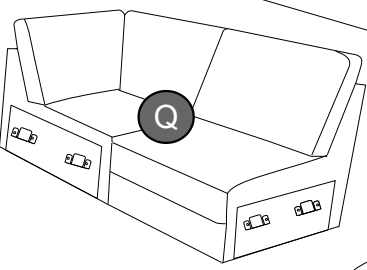
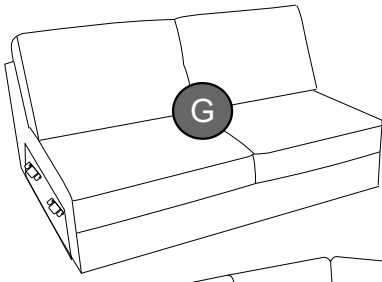
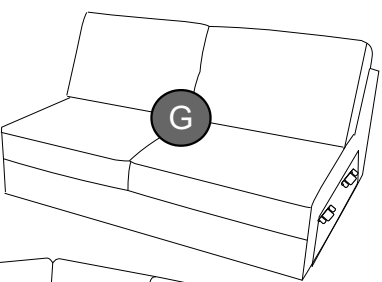
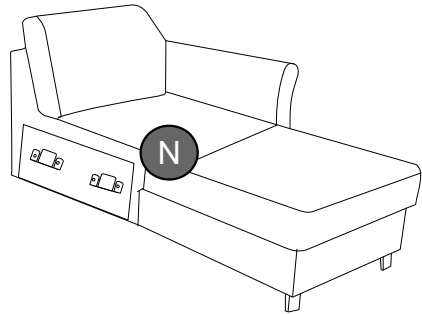
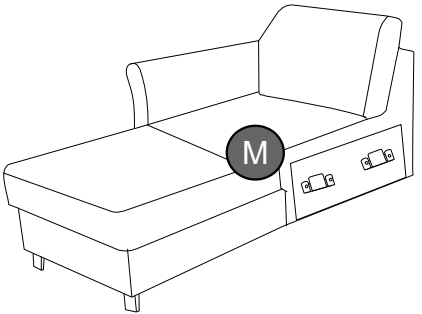

<b>Z</b> H-120  X1	<b>V</b> H-120  X1	<b>i</b> L-5  X1	<b>S</b> H-120  <b>S<sub>1</sub></b> X4	<b>q</b> M8*20  X4
---	---	---	--	---



<b>Z</b> H- 120 	<b>V</b> H- 120 	<b>i</b> L- 5 	<b>S</b> H- 120 	<b>q</b> M8*20 
X4	X2	X1	X7	X4

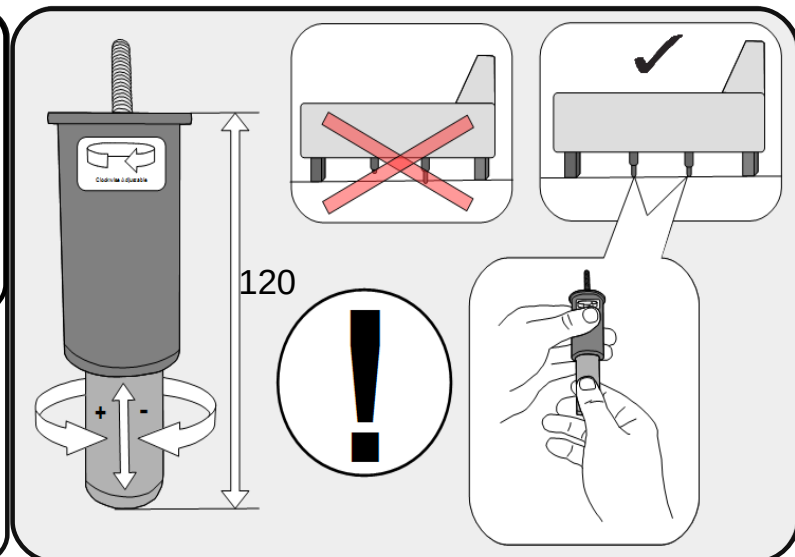
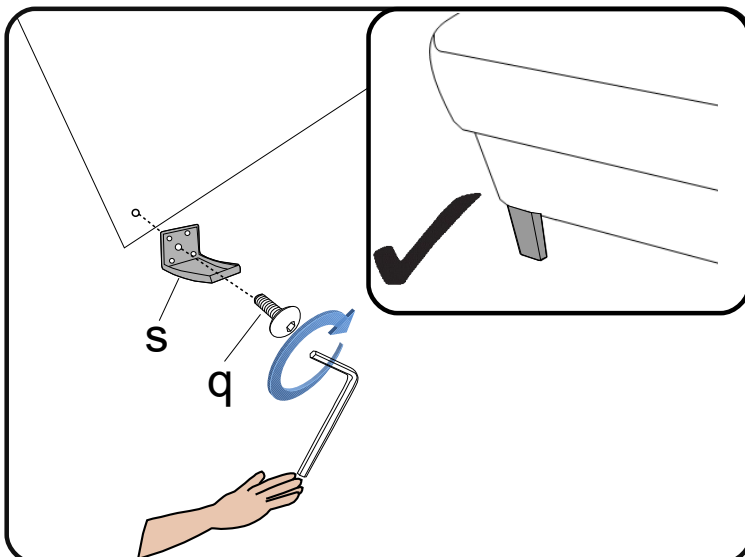
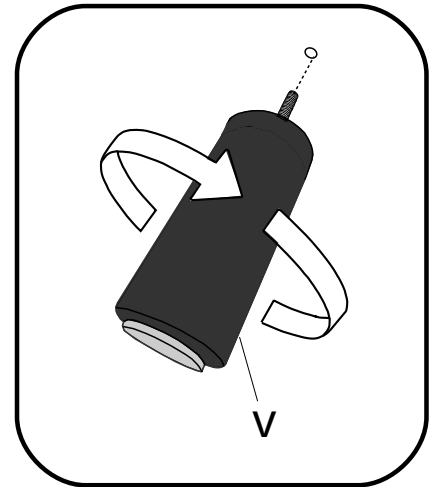
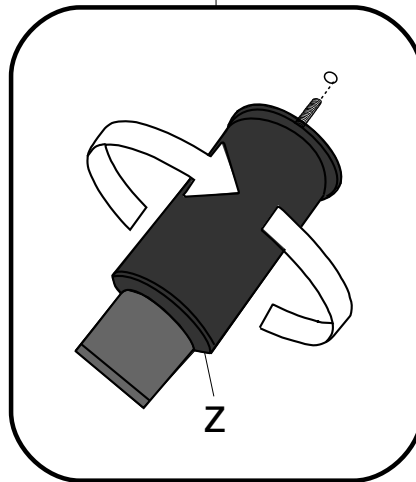
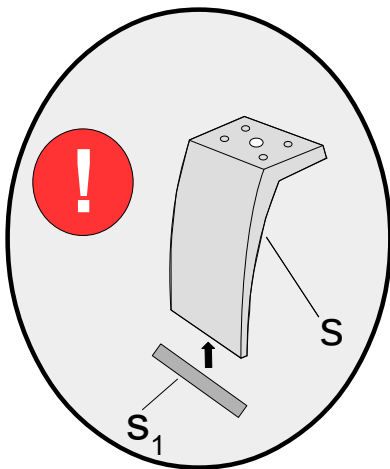
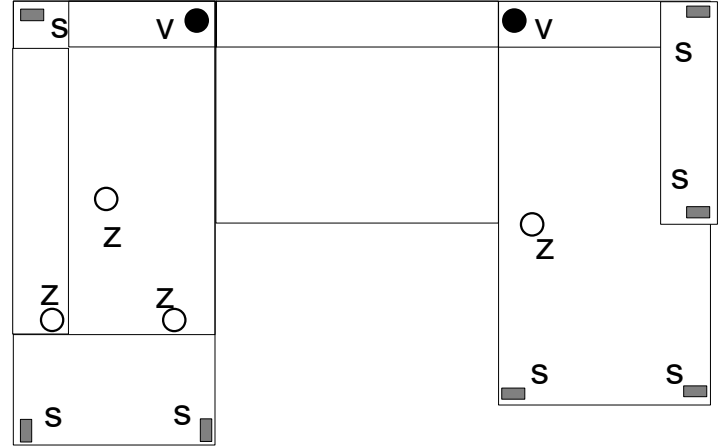
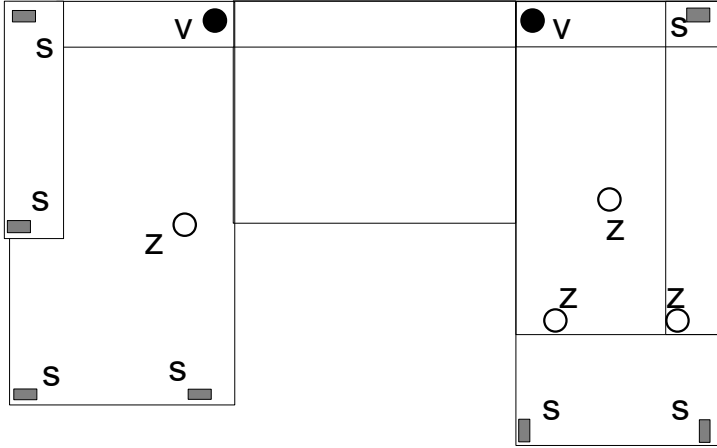
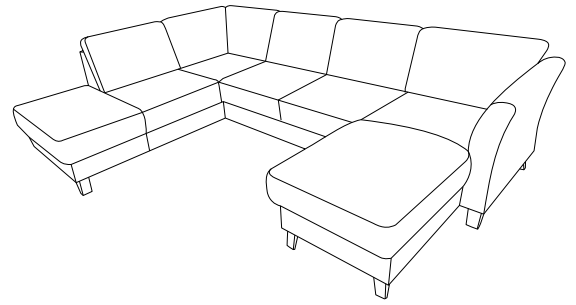
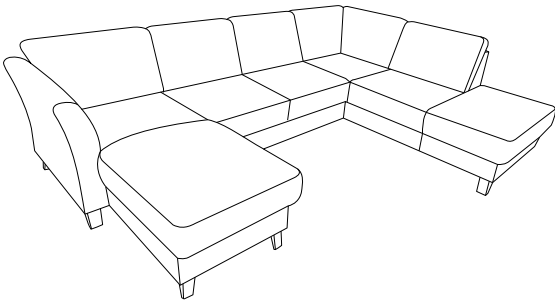

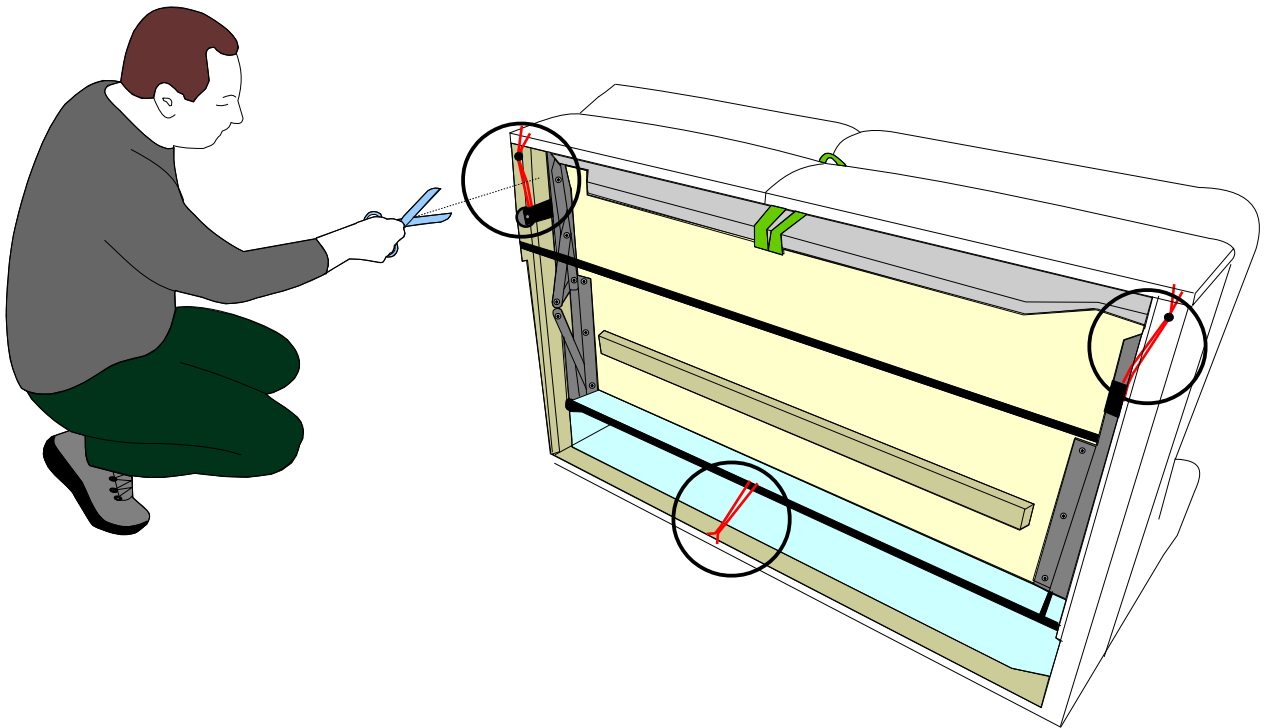
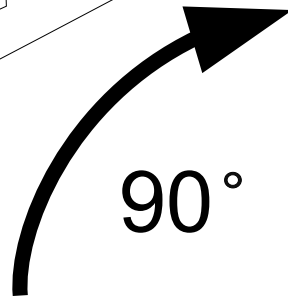
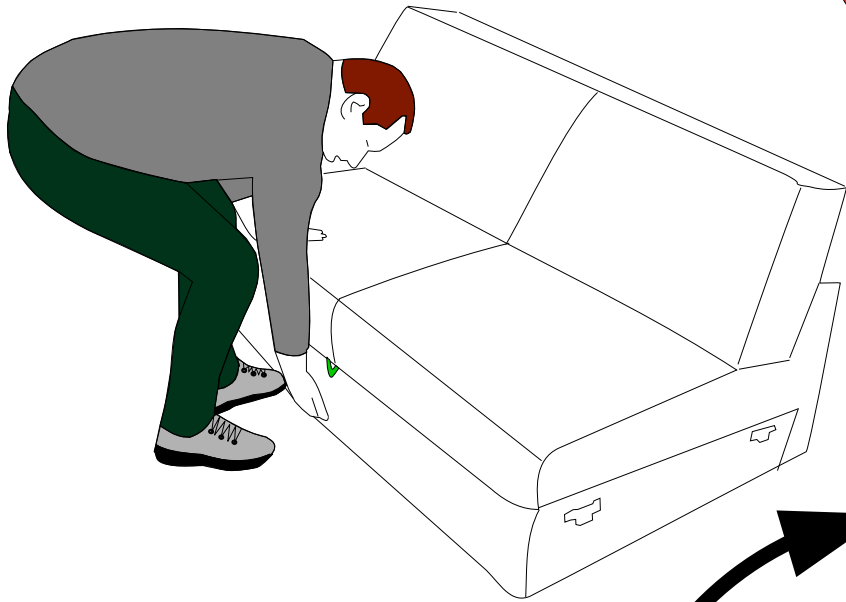

0019

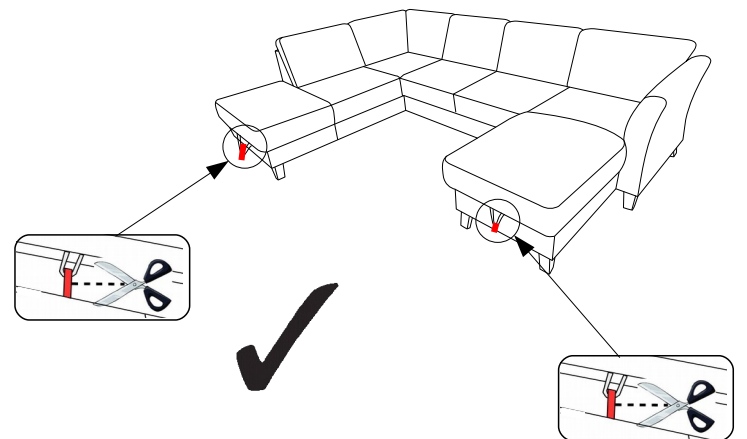
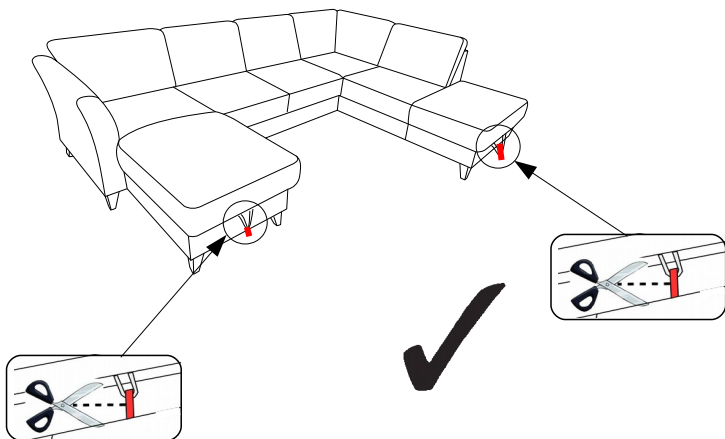
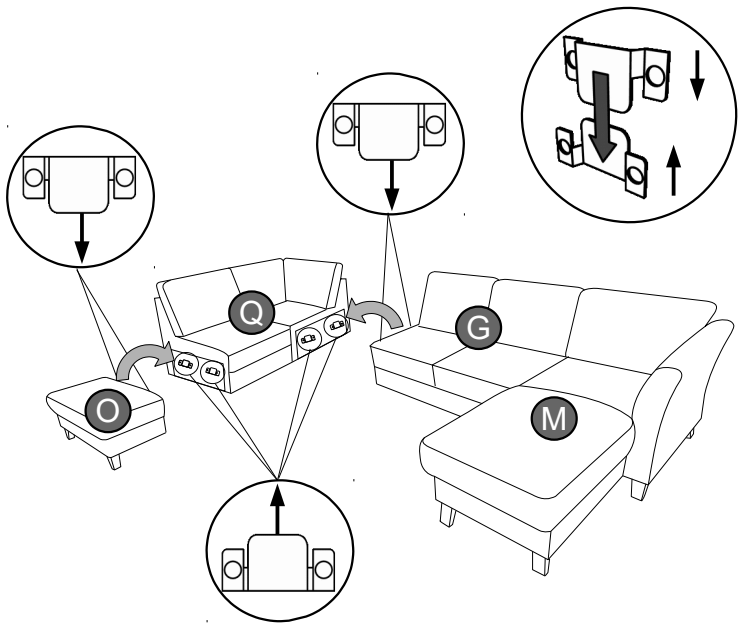
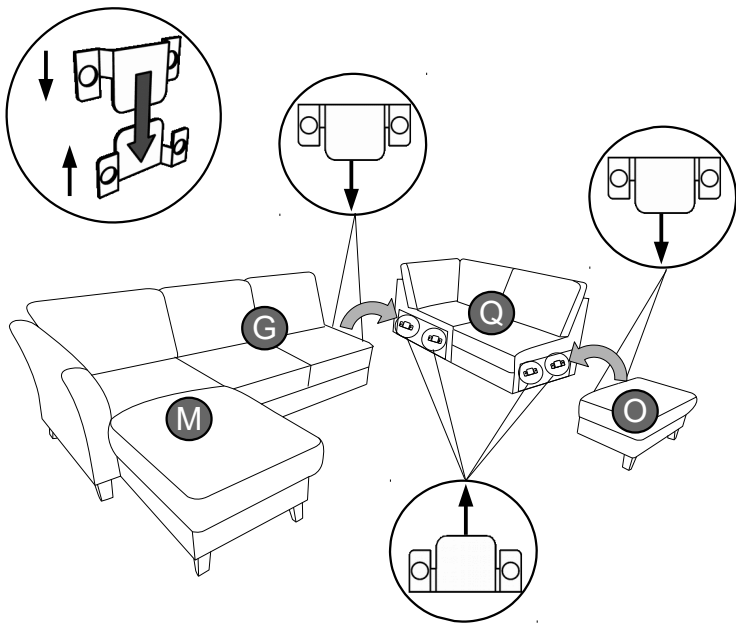
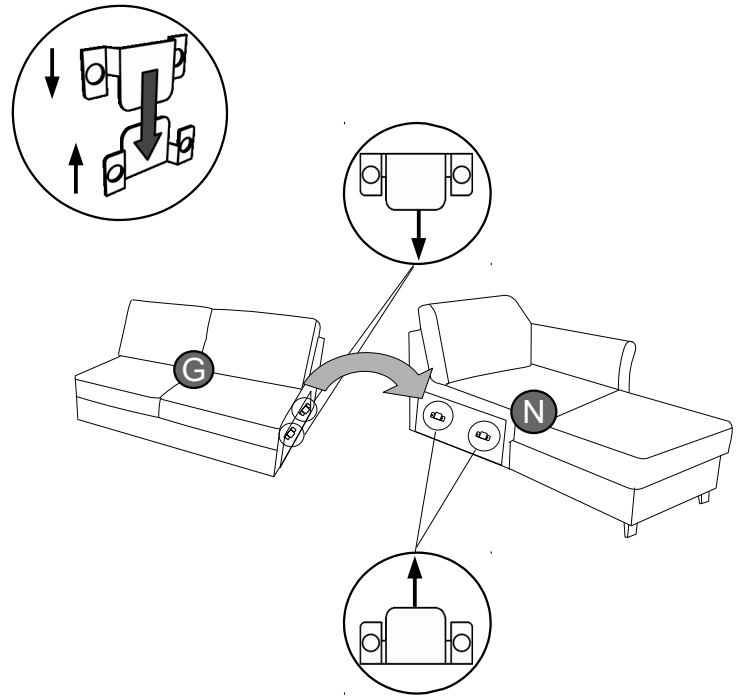
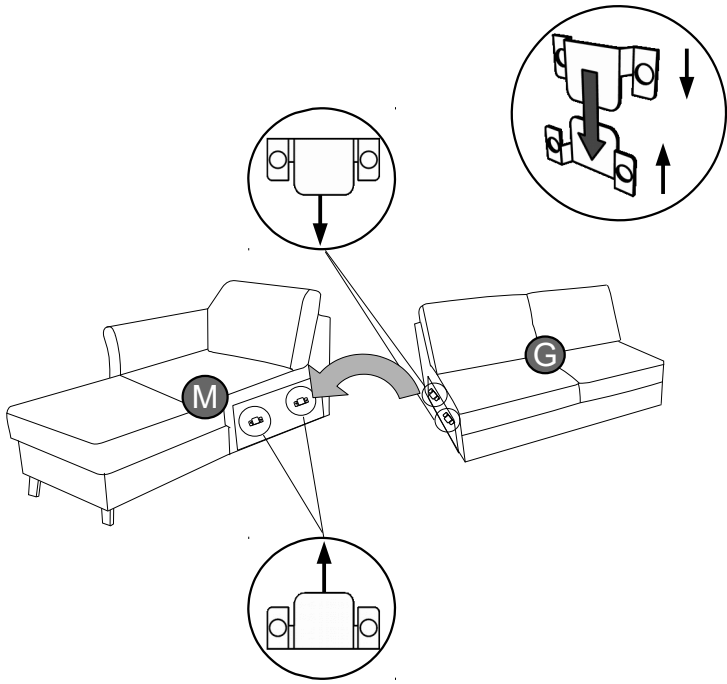
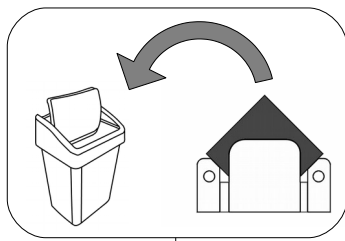

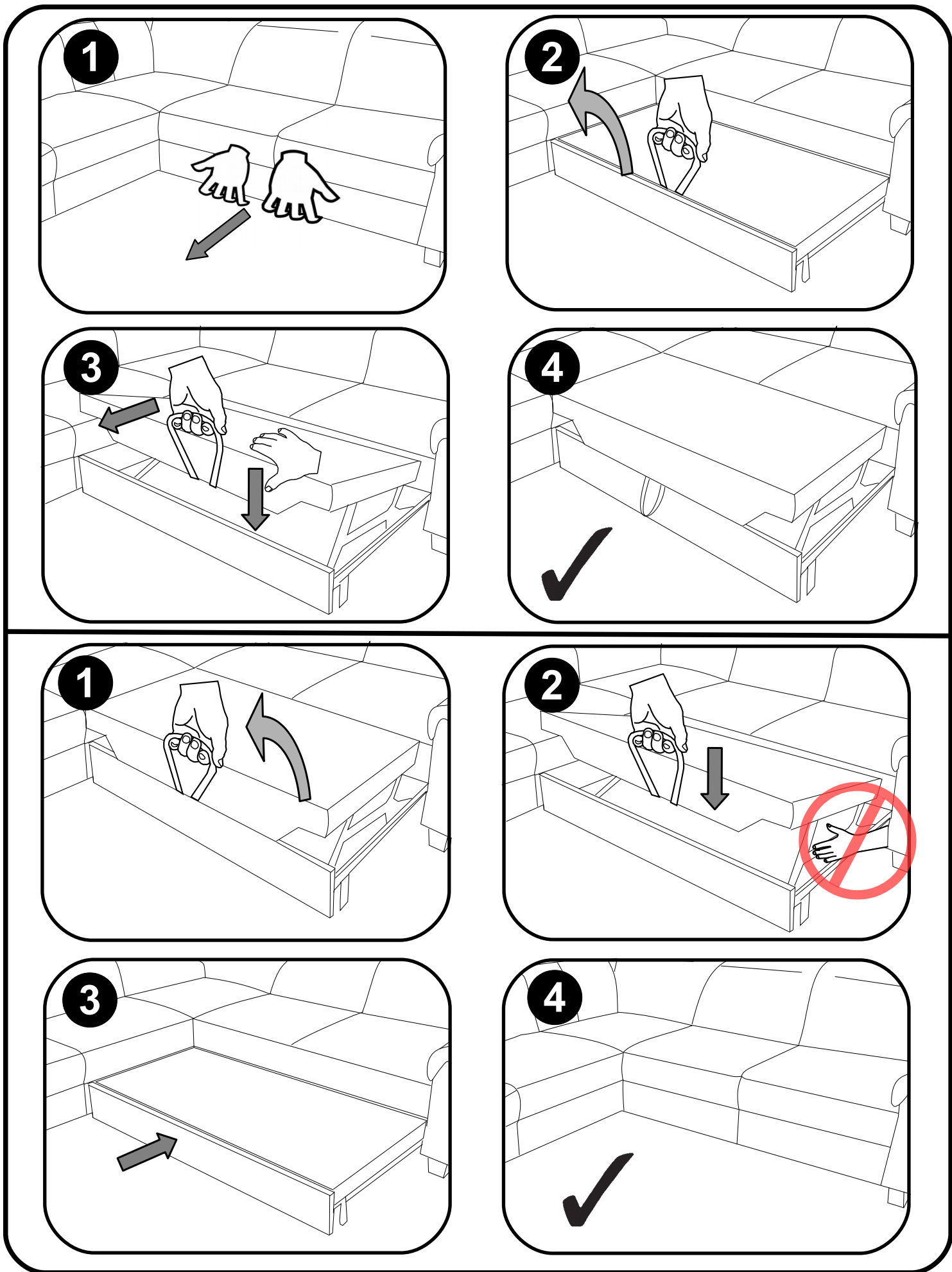
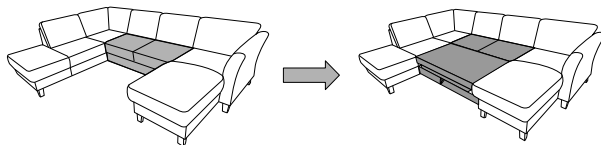



Service · Dienstverlening · Servis · Servis · Сервисная служба · Serviciu · Services · Servizio  
 ·Servisný list · Szolgáltatás · Servisní list

Name · Naam · Nazwa · İsim · Название · Nume · Nome · Názov · Názov ·  
 Název · Neve

**VISBY V**

Typ · Type · Tip · Тип · Tipo · Típus

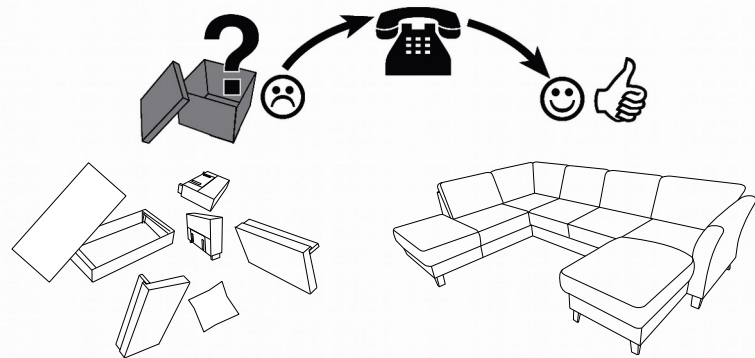
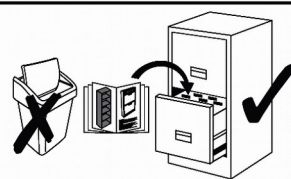

**R**

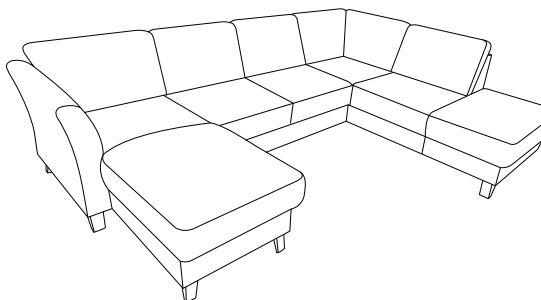

**L**

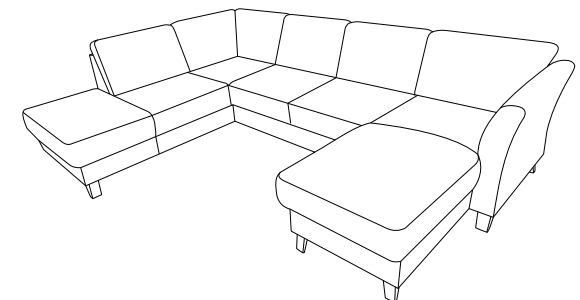

<b>Z</b> H-120 	<b>V</b> H-120 	<b>i</b> L-5 	<b>S</b> H-120  <b>S<sub>1</sub></b> 	<b>q</b> M8*20 [mm] 
--------------------	--------------------	------------------	--	-------------------------

