

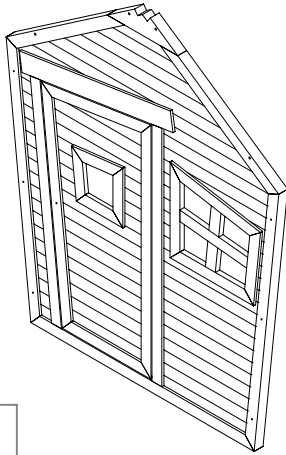

Robin

A030.067.00



1

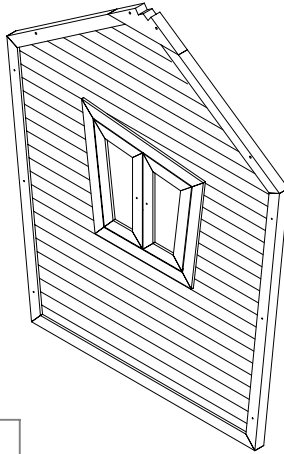

3

4



14x

t1

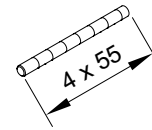

7x

s2

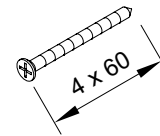

16x

A030.068.00

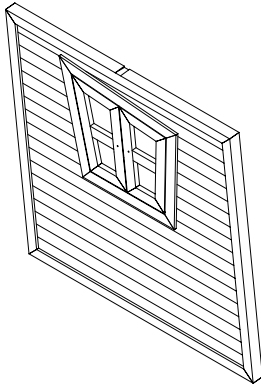

2

2x

A030.069.00

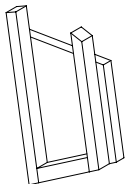

6

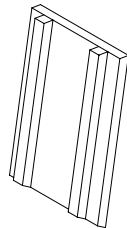

7

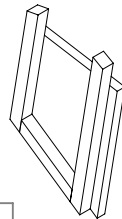

8

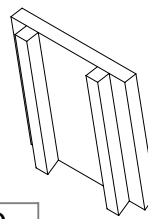

9

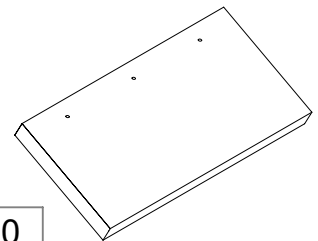

10

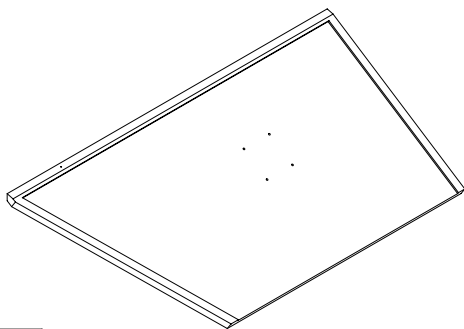

11

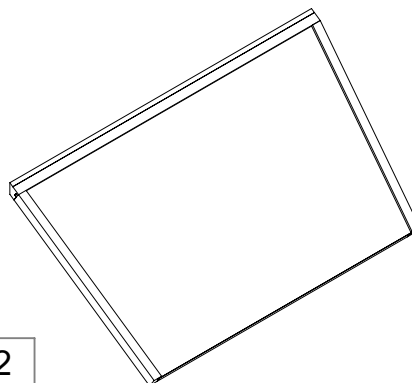

12

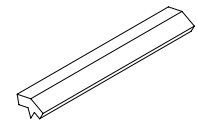

10A

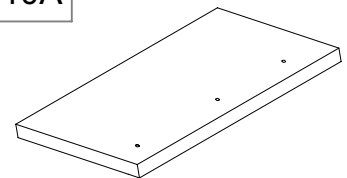

10B

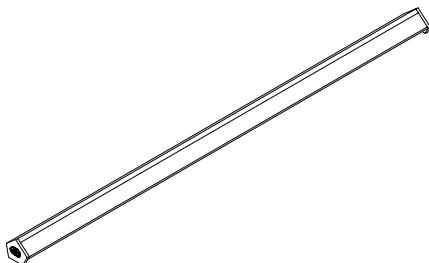

13

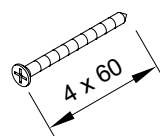

s2

8x

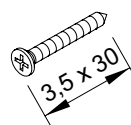

s3

16x

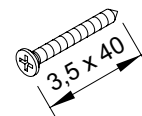

s4

15x



s6

6x



Robin

A030.076.00

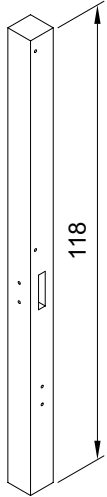

15

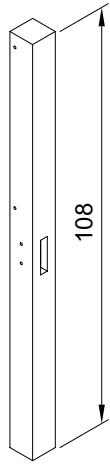

16

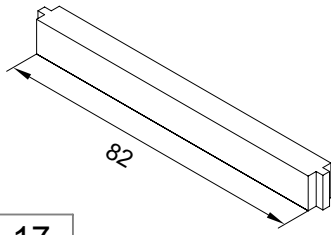

17

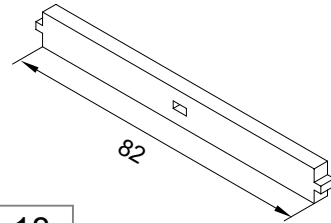

18

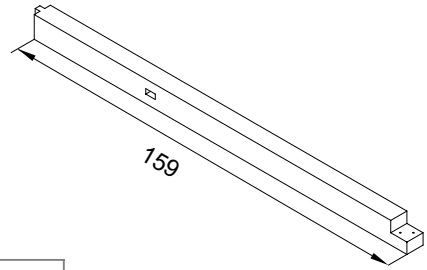

19

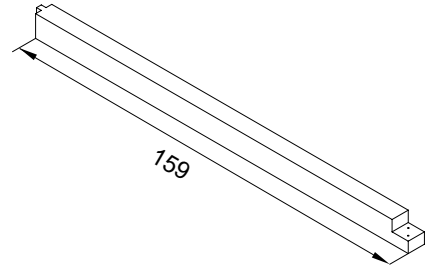

20

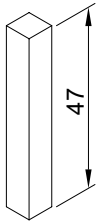

21

2x

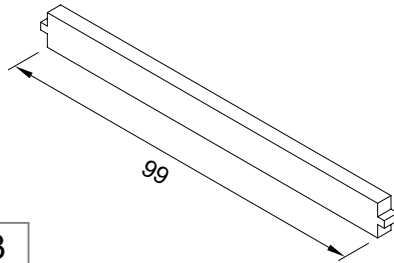

23

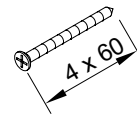

s2

18x

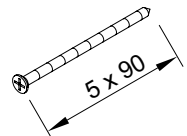

s5

40x

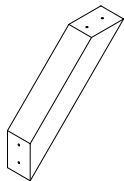

22

8x

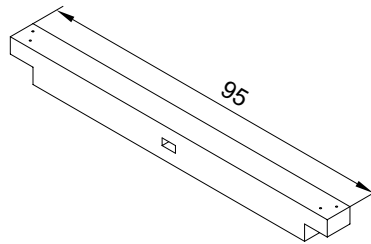

24

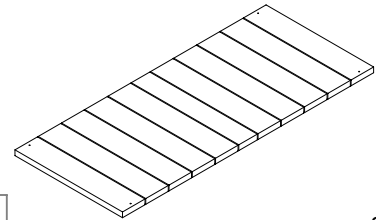

5

2x

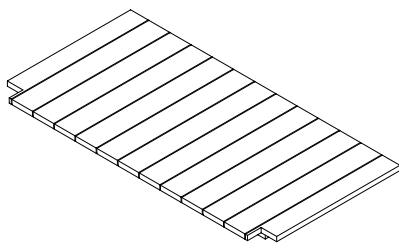

25

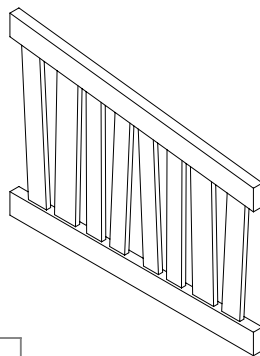

26

A030.031.00

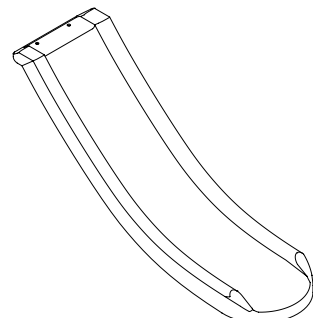

27

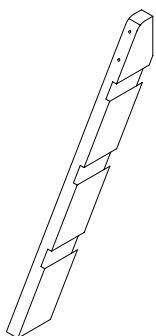

28

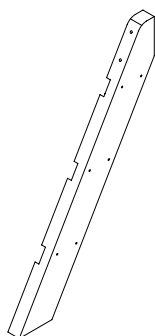

29

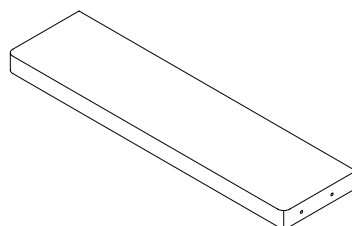

30

3x

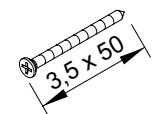

s1

24x

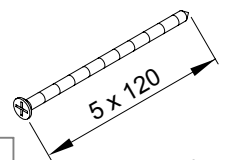

s7

4x

15		16		17		22		2x	s5		8x	s2		4x
----	--	----	--	----	--	----	--	----	----	--	----	----	--	----

A030.076.00

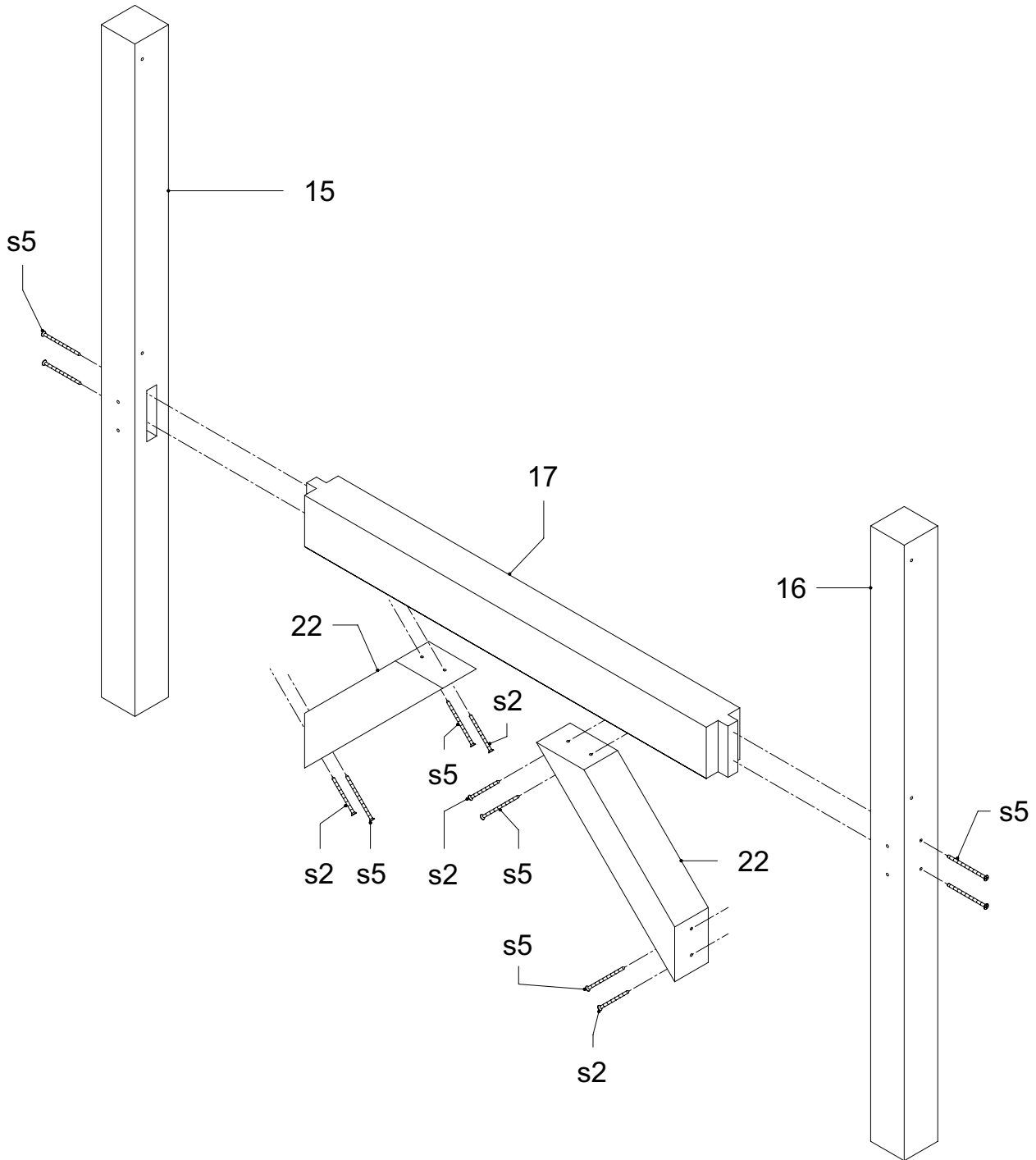



 18	 19	 21	 1x 22	 2x s5	 9x s2	 4x s2
--------	--------	--------	-----------	-----------	-----------	-----------

A030.076.00

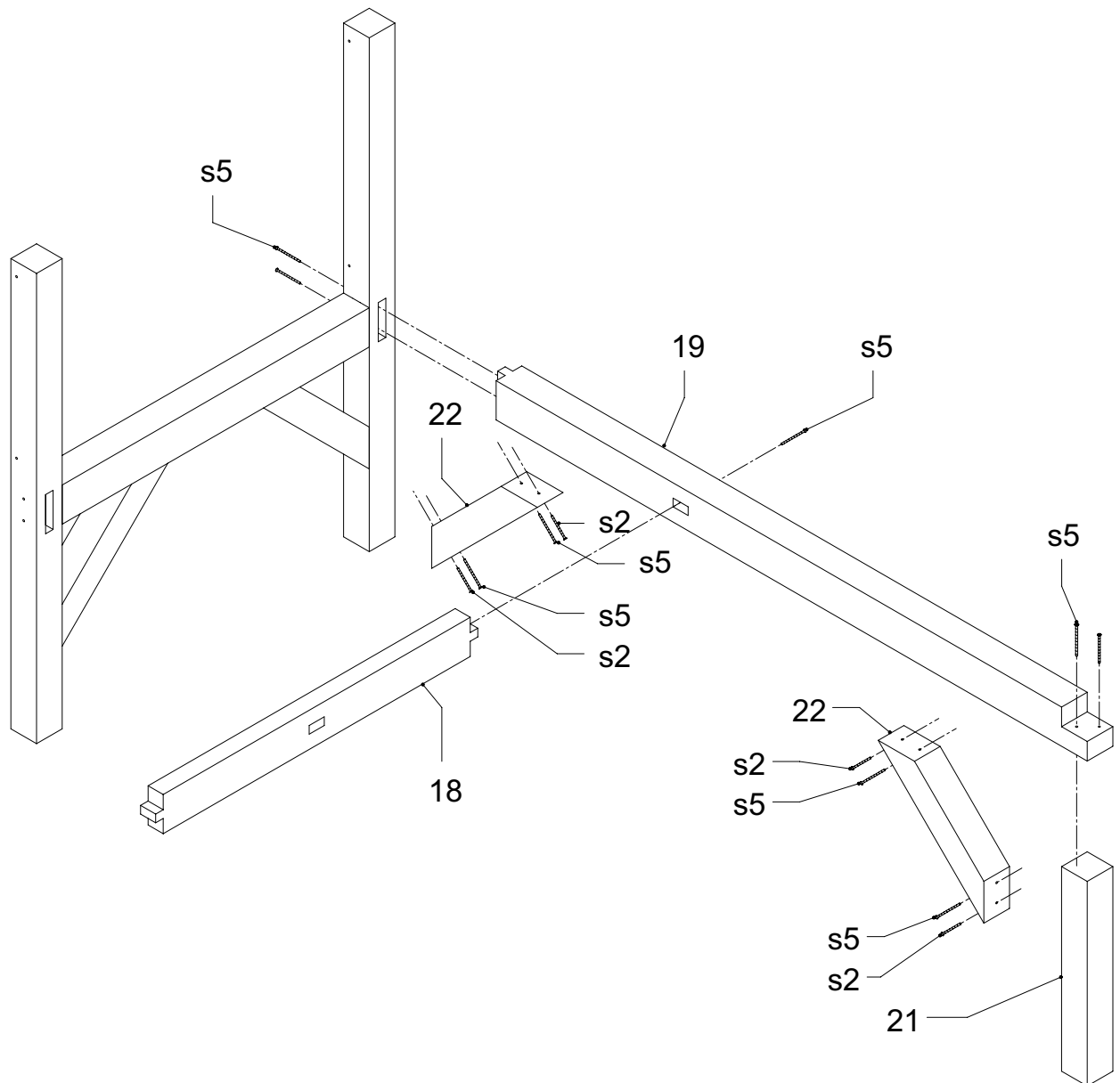



Robin

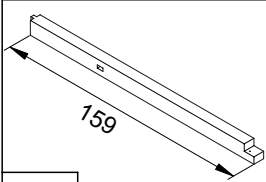

20

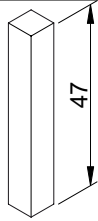

21

1x

22

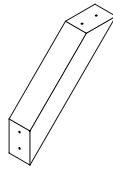

2x

s5

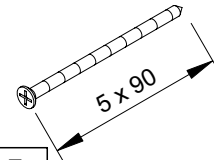

9x

s2

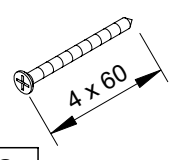

4x

A030.076.00

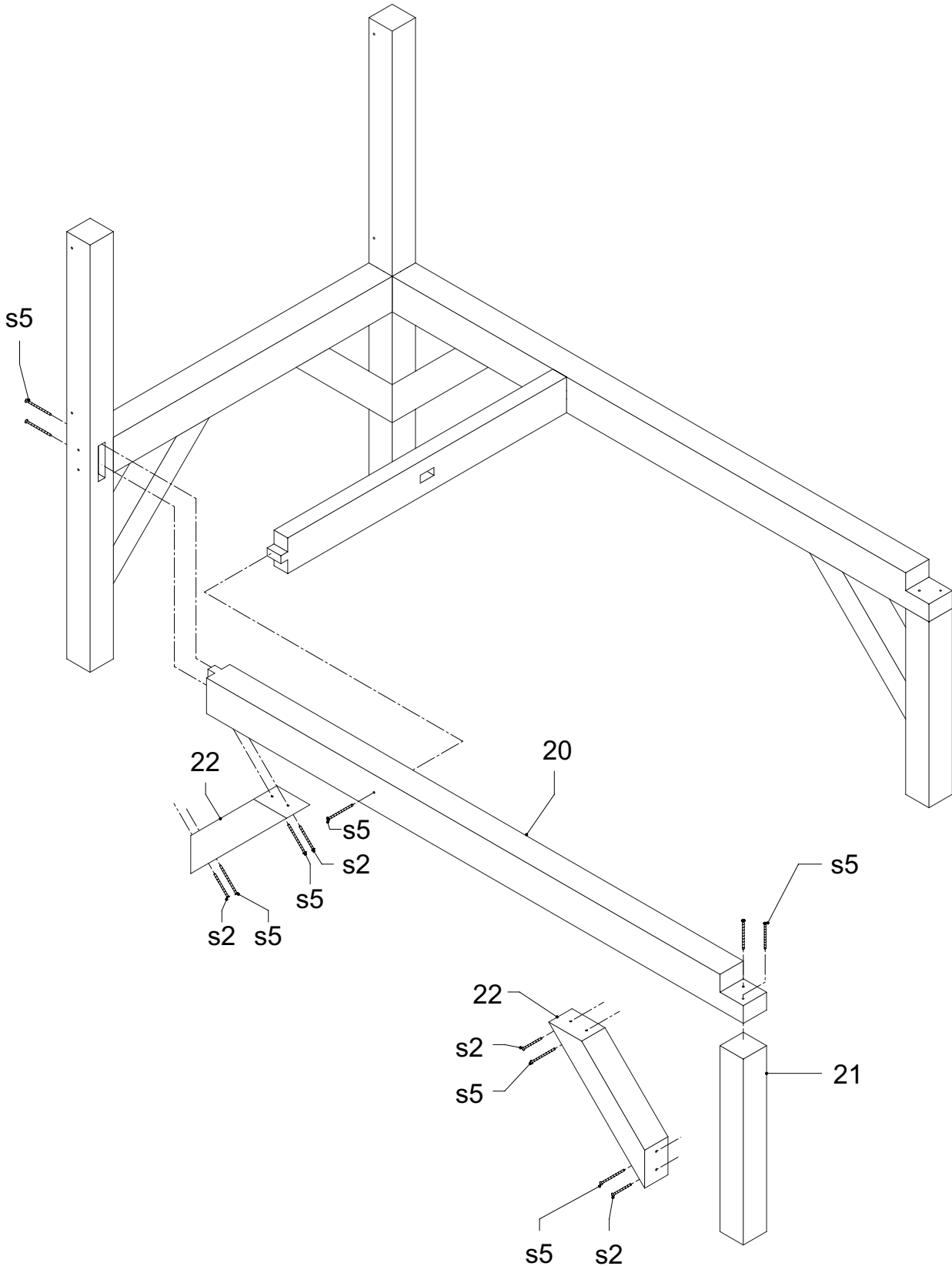

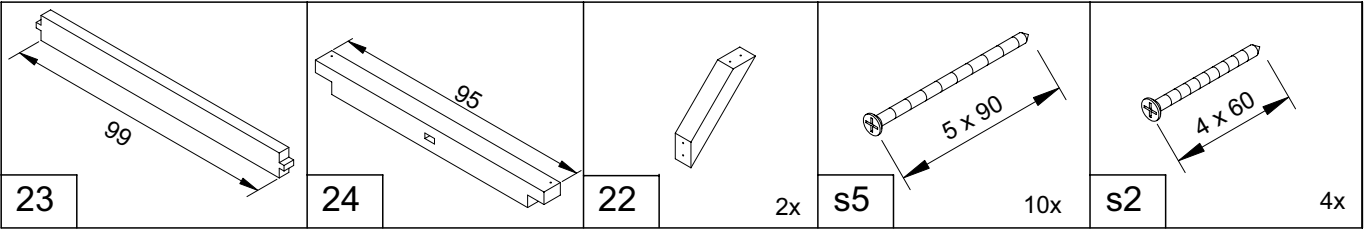

A030.076.00

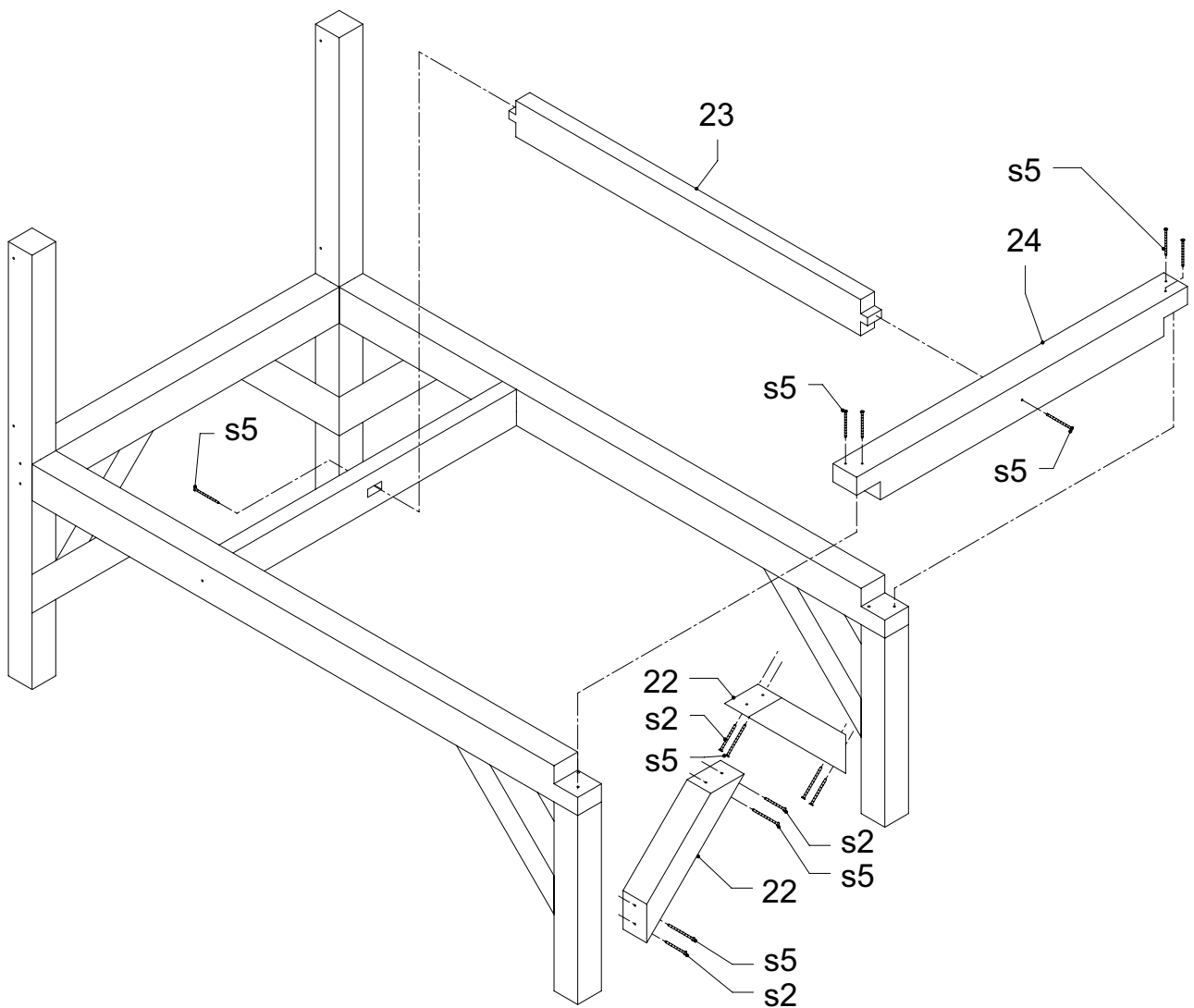

1	2x	3	14x	t1 7x	s2 16x

A030.067.00 + A030.068.00

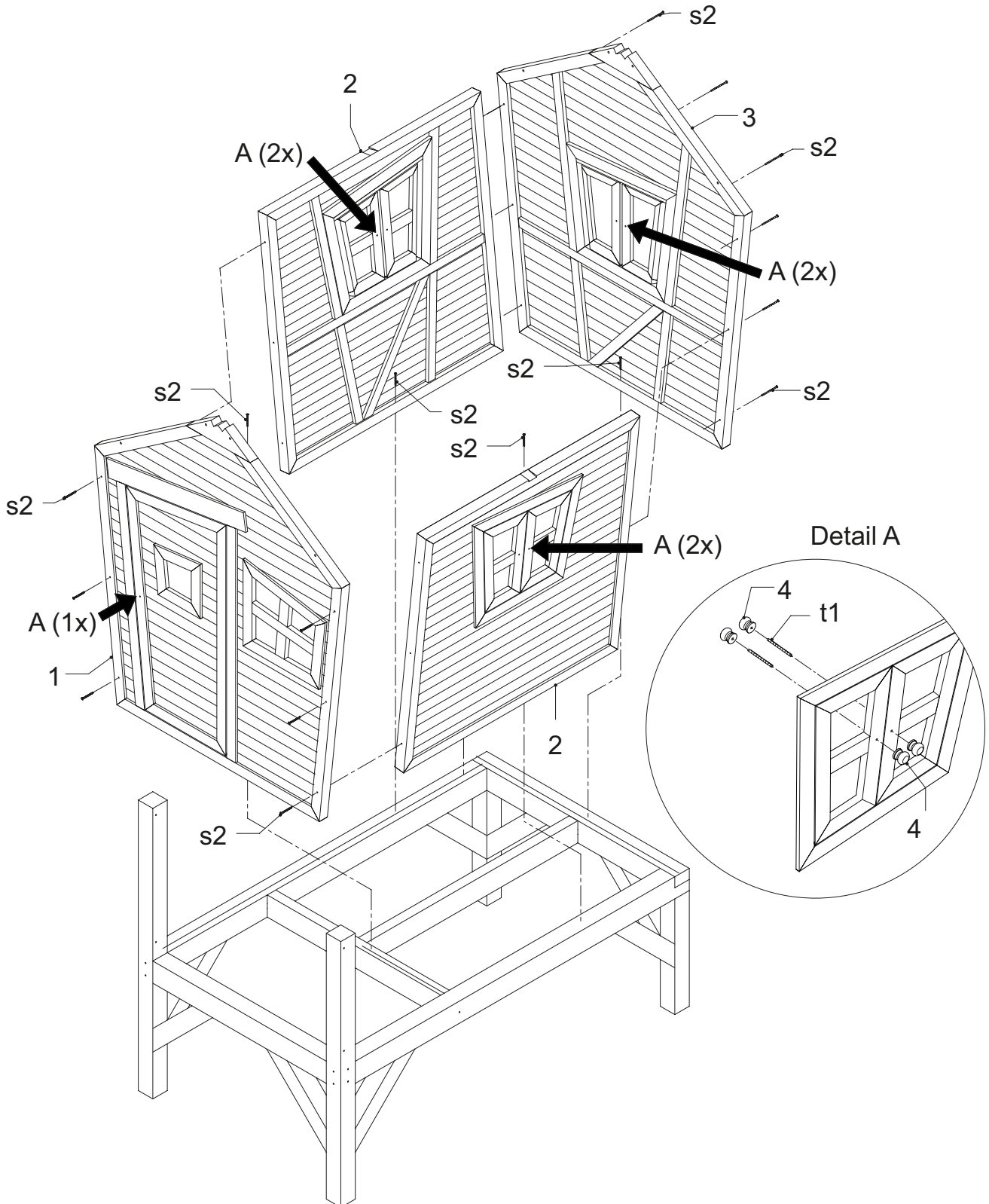

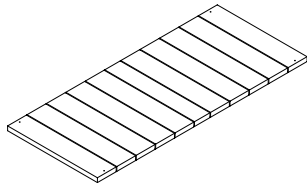

5

2x

s1

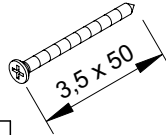

8x

A030.076.00

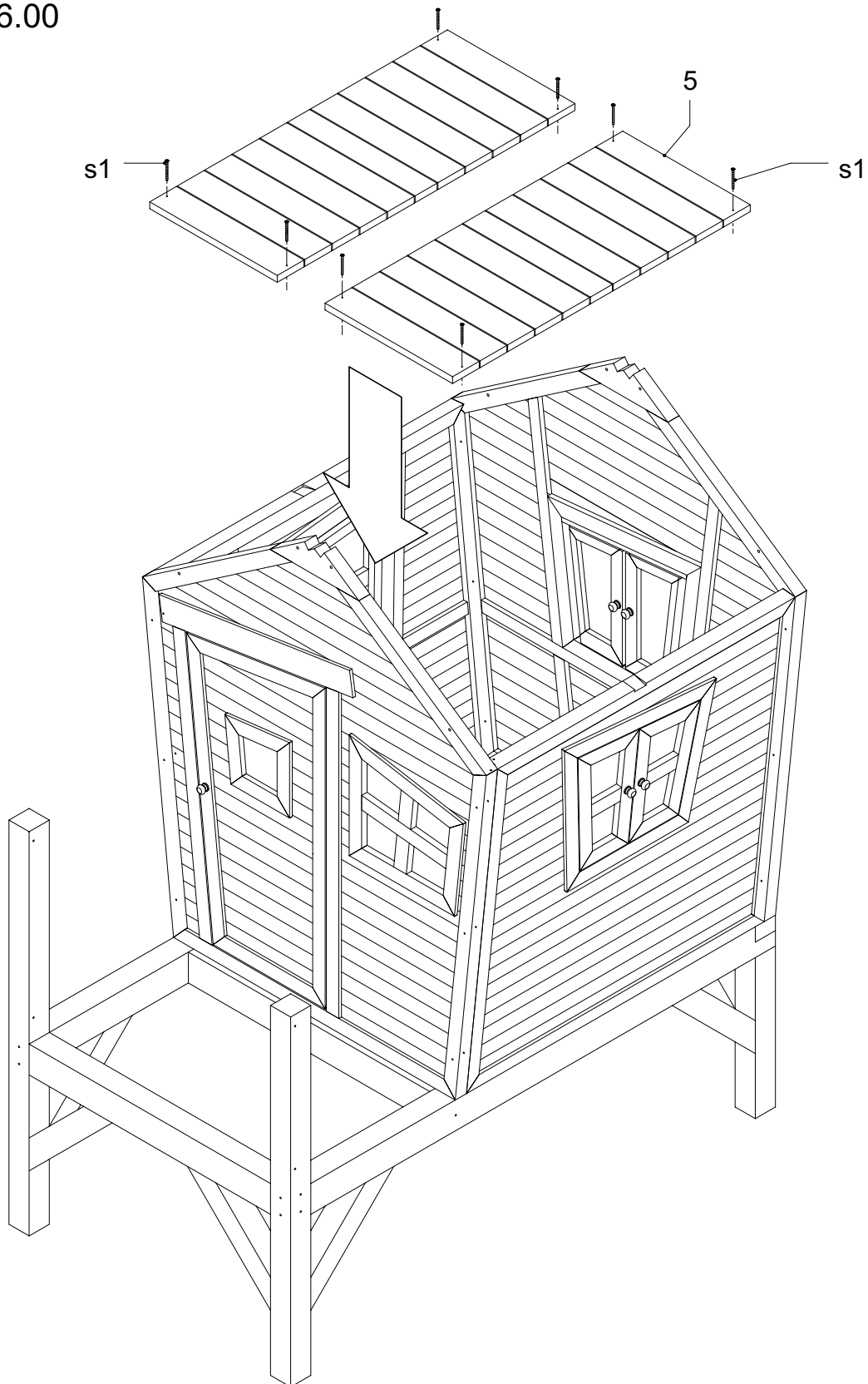



Robin

6	7	8	9	10	10A	10B	11	s3 16x	s6 6x

A030.069.00

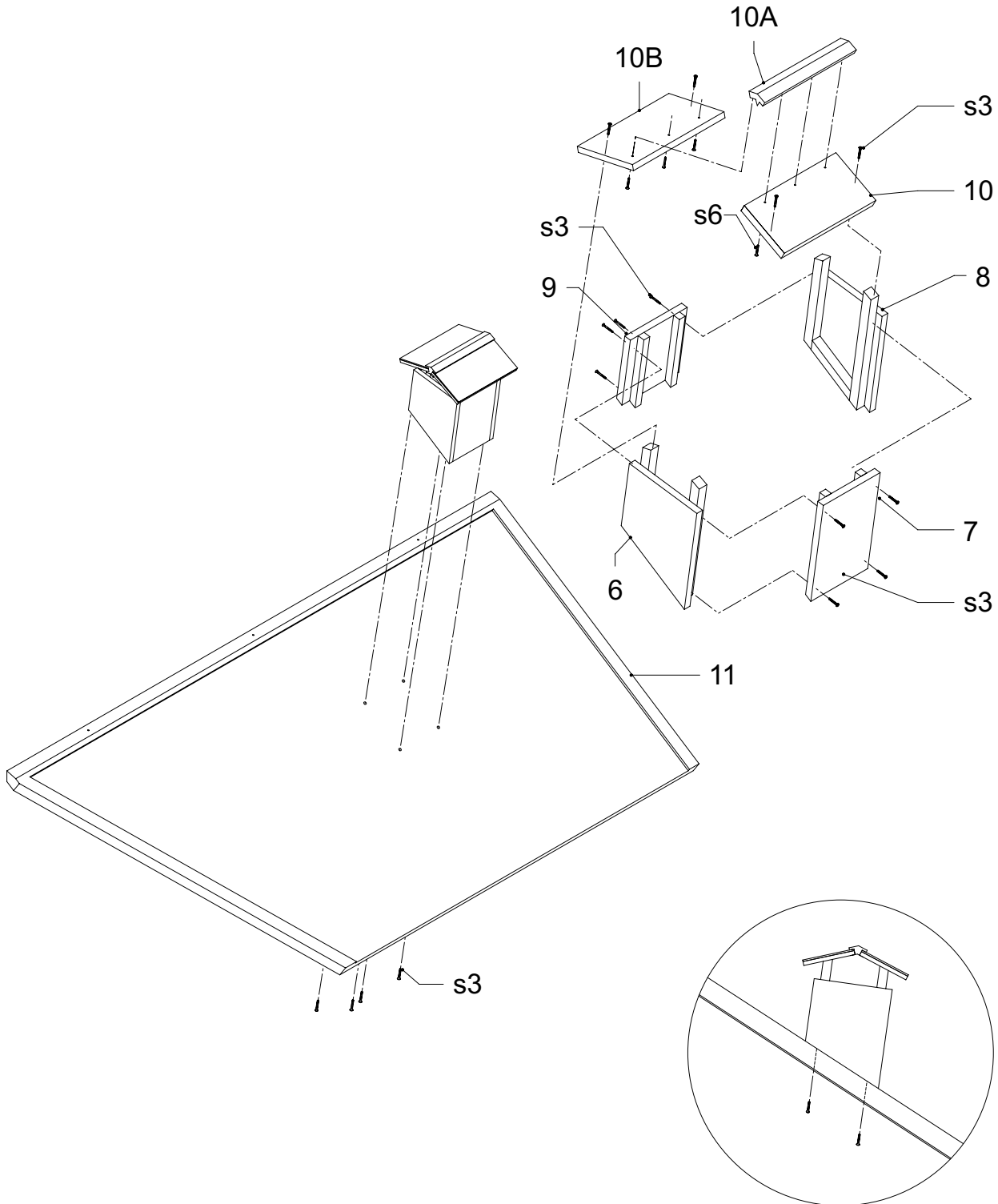

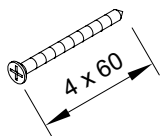

s2

4x

A030.069.00

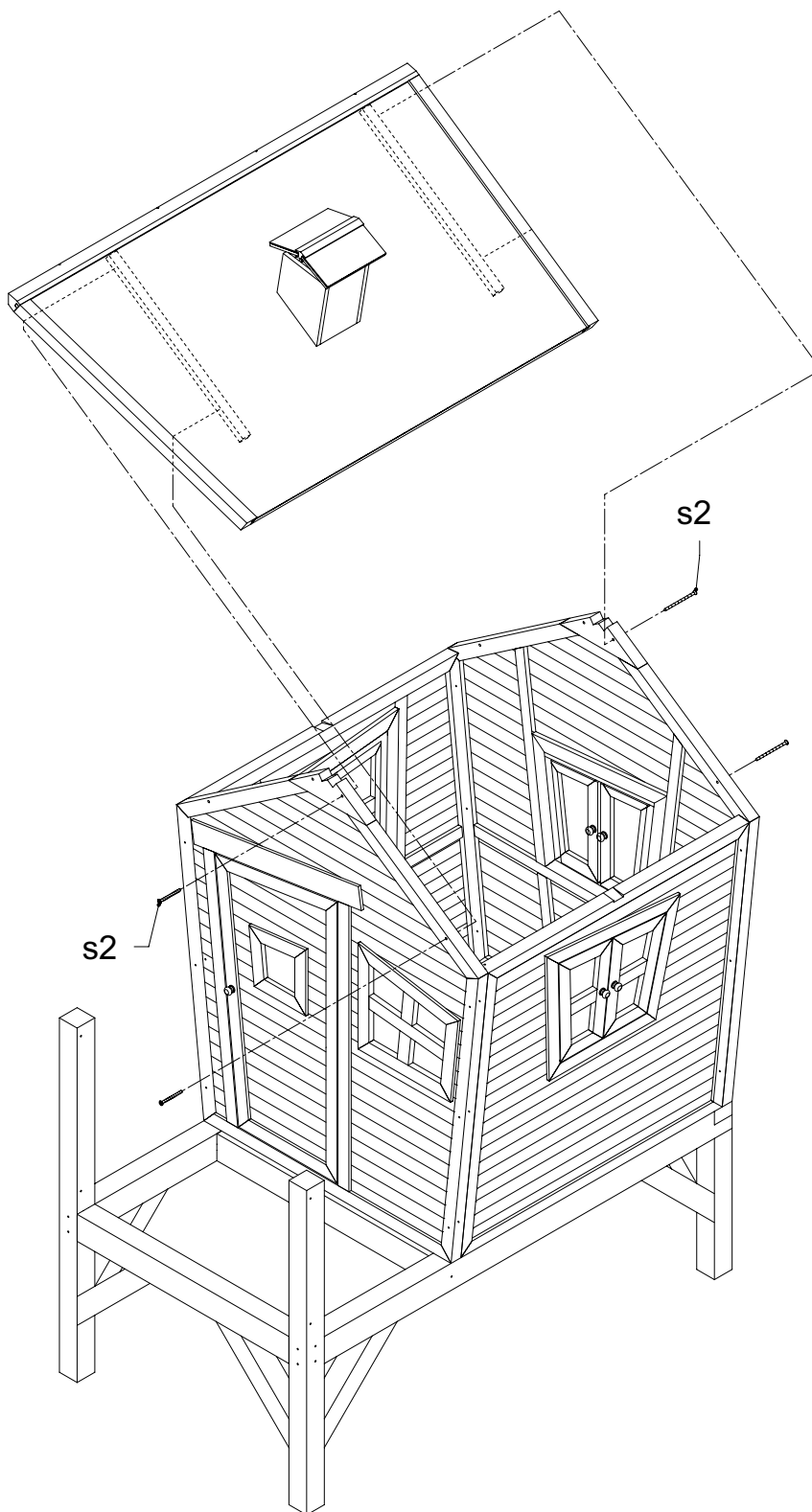

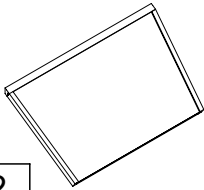

12

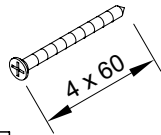

s2

4x

A030.069.00

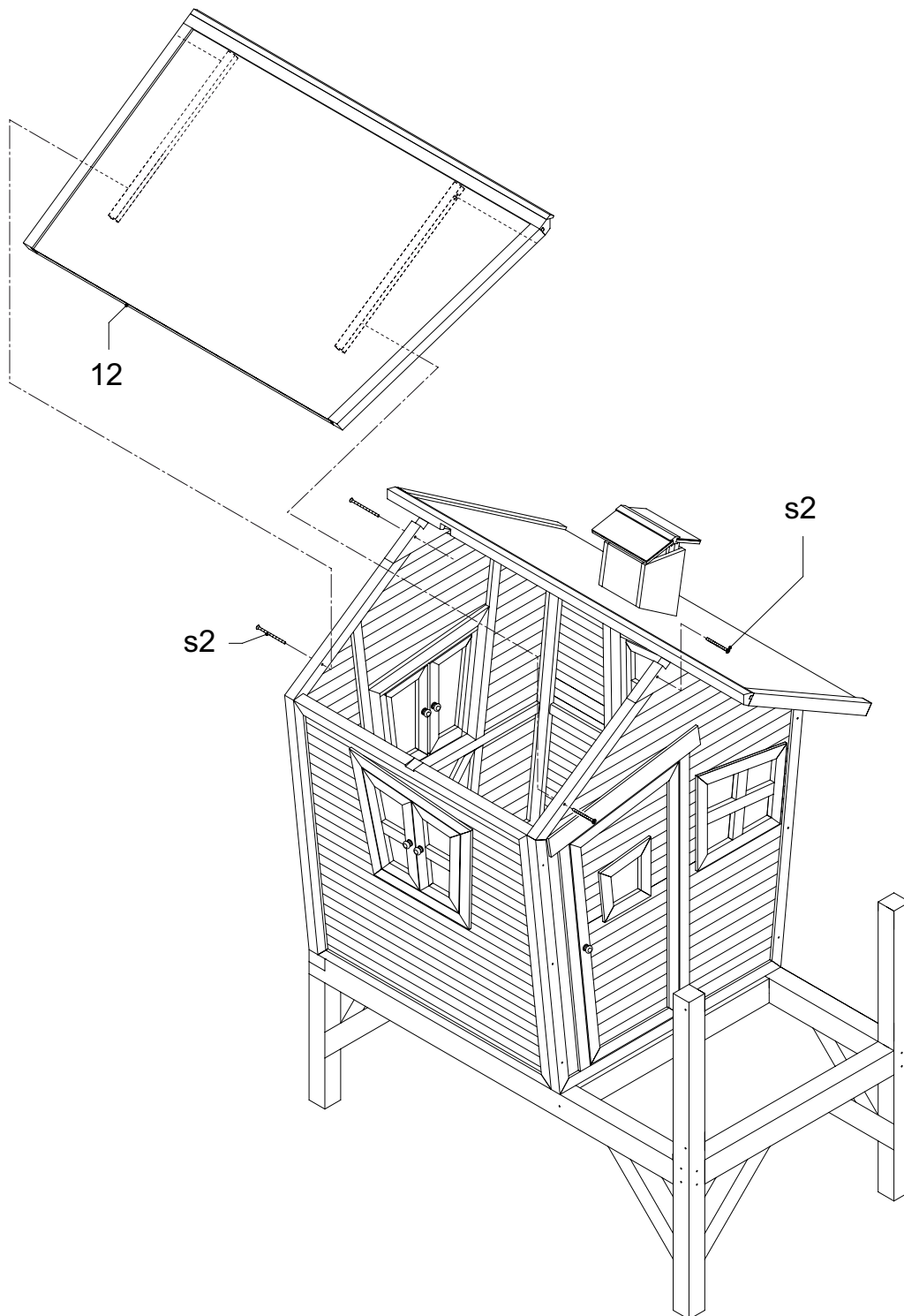

13

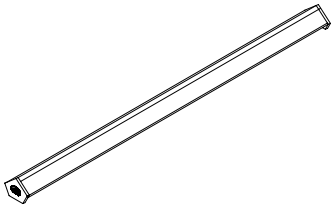

s4

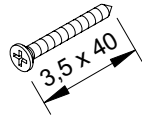

15x

A030.069.00

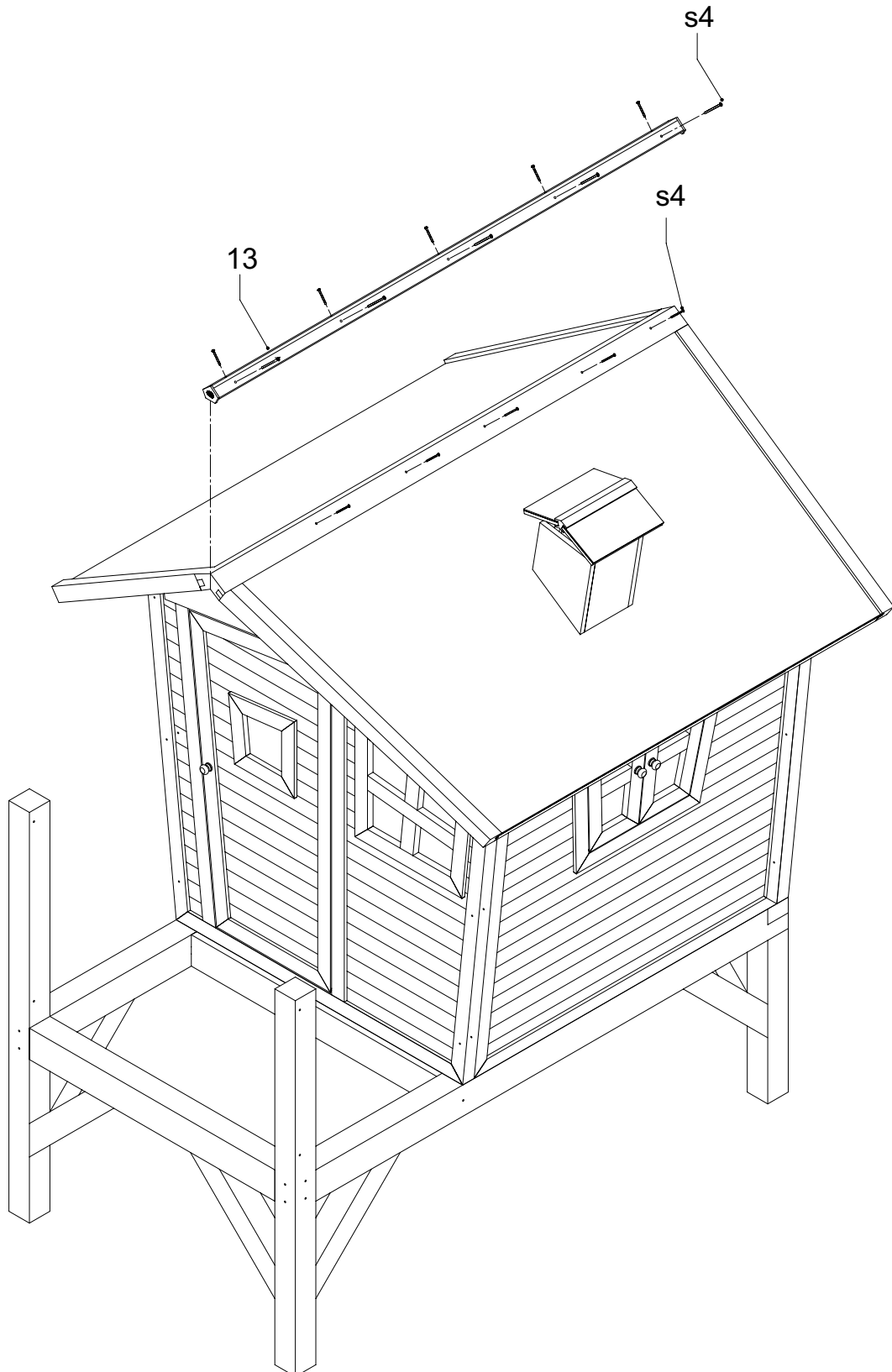

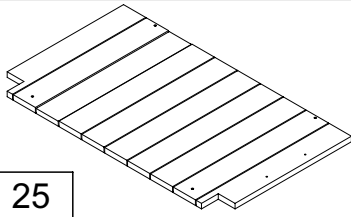

25

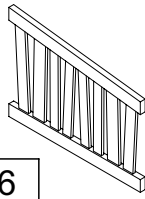

26

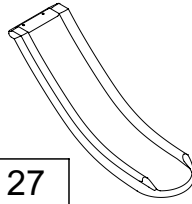

27

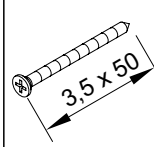

s1

4x

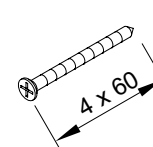

s2

2x

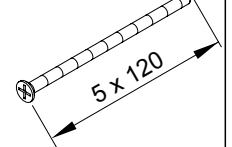

s7

4x

A030.031.00 + A030.076.00

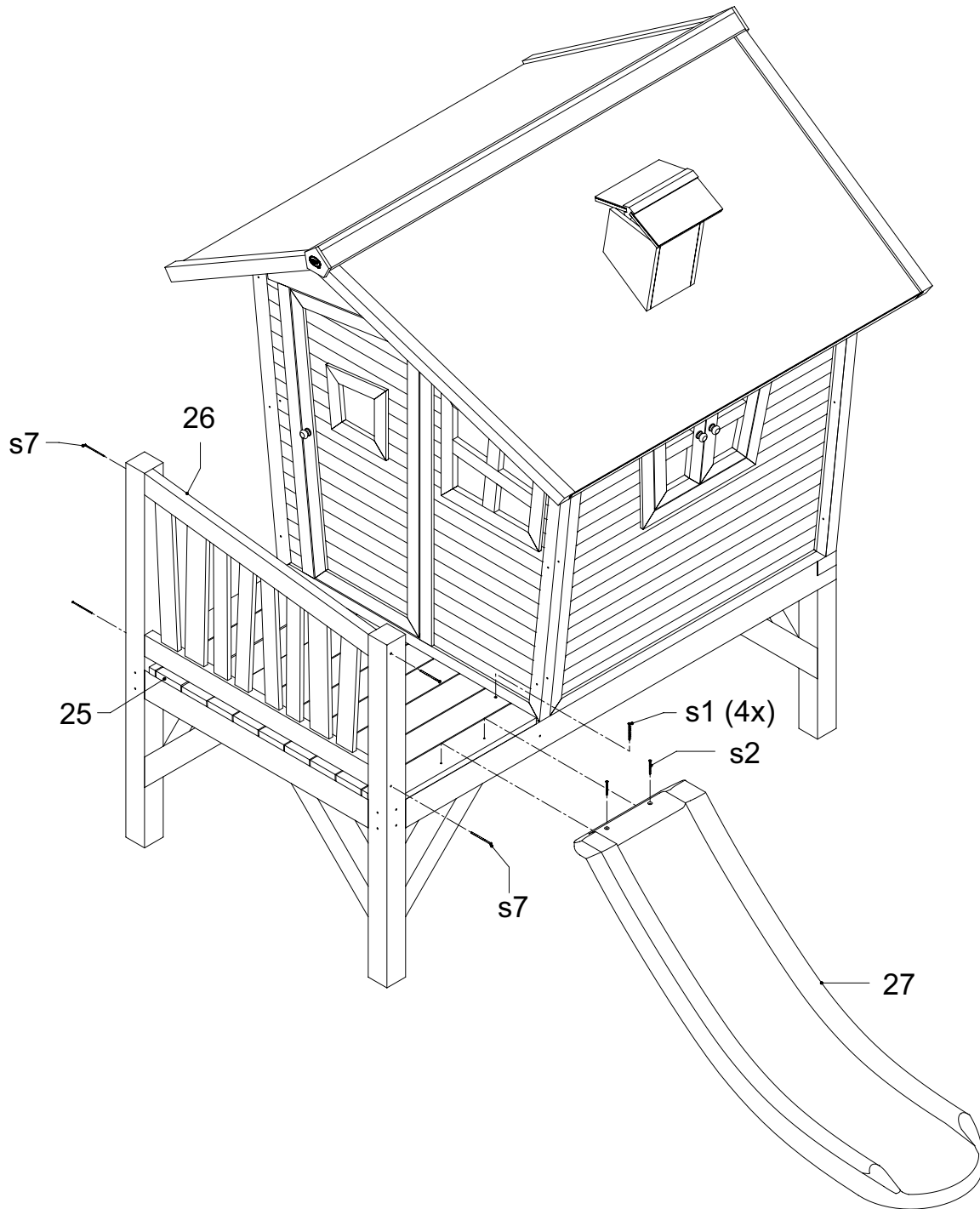

30	3x	28	29	s1	12x	s5	4x

A030.076.00

