

pelipal

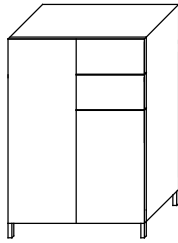

MOT-NZ0851S1 A4
Datum 05/09/19

3 _ _ -016051

T1 Bitte unbedingt ausfüllen!

Name _____
Strasse _____
PLZ _____ Ort _____
Tel. _____

T2 Sehr geehrte Kunden,
wir freuen uns, dass Sie sich für ein Produkt aus dem Hause Pelipal entschieden haben. Sollte es trotz aller Bemühungen unsererseits, Ihnen ein qualitativ hochwertiges Möbelstück zu liefern, zu Fehlteilen kommen, schicken Sie bitte dieses ausgefüllte Blatt an

Fax.: **+49 3443/434350**

E-Mail: **ersatzteile@pelipal.de**

Bitte beachten Sie, dass Bauteile über 800mm Länge und 350mm Breite direkt bei Ihrem Möbelhändler zu beanstanden sind. Zur Reklamationsbearbeitung ist es unbedingt erforderlich **die Artikelnummer des Schrankes**, welche auf dem Etikett ersichtlich ist und den Markt, wo das Möbel erworben wurde anzugeben. Außerdem tragen Sie unten bitte die benötigte Stückzahl ein. Viel Spaß mit Ihrem neuen Badmöbel!

Ihr Pelipal Team

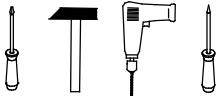





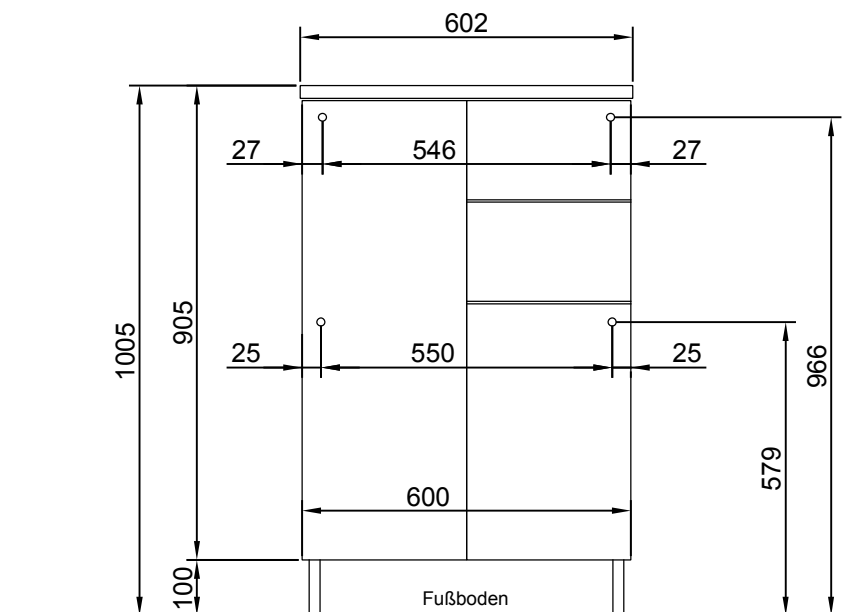



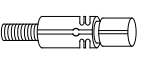

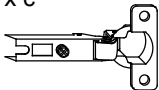
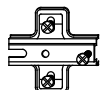

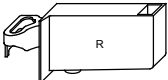
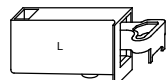





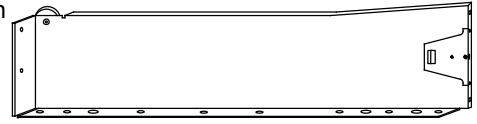



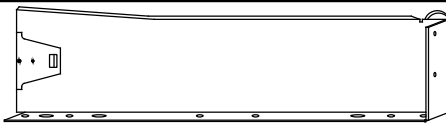

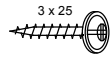
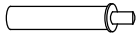
T3 Für den Zusammenbau sind 2 Personen erforderlich.

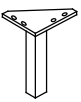
T4 Montage-Richtzeit 3 Stunden

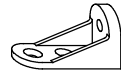
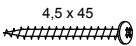

Die Maßangabe der Höhe ist nicht bindend!

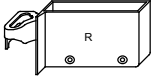
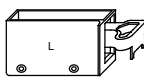
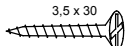
16 x a  DUEB-SMD-000005	Stück	16 x b  EXZENTER-000015	Stück	4 x c  TBD-35-115X00	Stück	4 x d  ZPL-003X004	Stück	4 x e  TRAE-001-000020	Stück
1 x j  AUF-001-000080	Stück	1 x k  AUF-001-000090	Stück	20 x l  SCH-SPA-035X015	Stück	2 x f  2 x g 			
4 x m  SCH-KA-063X011	Stück	4 x n  SCH-KA-063X016	Stück	4 x o  ADK-AL1-005X008	Stück	2 x h 			
4 x p  Griff	Stück	8 x q  SCH-RDK-035X015	Stück	20 x r  SCH-RDK-035X015	Stück	2 x i  KA-SZ-270X085			
4 x s  AUF-001-000020	Stück	7 x t  DTS-15X2X4,9	Stück	7 x u  SCH-RWD-030X025	Stück	2 x v  TUER-DAEM-000010	Stück	2 x w  TUER-ADA-000010	Stück
4 x x  FSS-EF-CRG100E-311	Stück	16 x y  SCH-SPA-035X020	Stück	8 x z  DTS-20X4X6,5	Stück	8 x φ  NAGEL-025X001	Stück	1 x β  VBD-000020	Stück
1 x λ  SCH-RDK-045X045	Stück	1 x π  SCH-RDK-040X015	Stück	1 x ξ  AUF-001-000085	Stück	1 x ψ  AUF-001-000095	Stück	4 x α  SCH-SPA-035X030	Stück

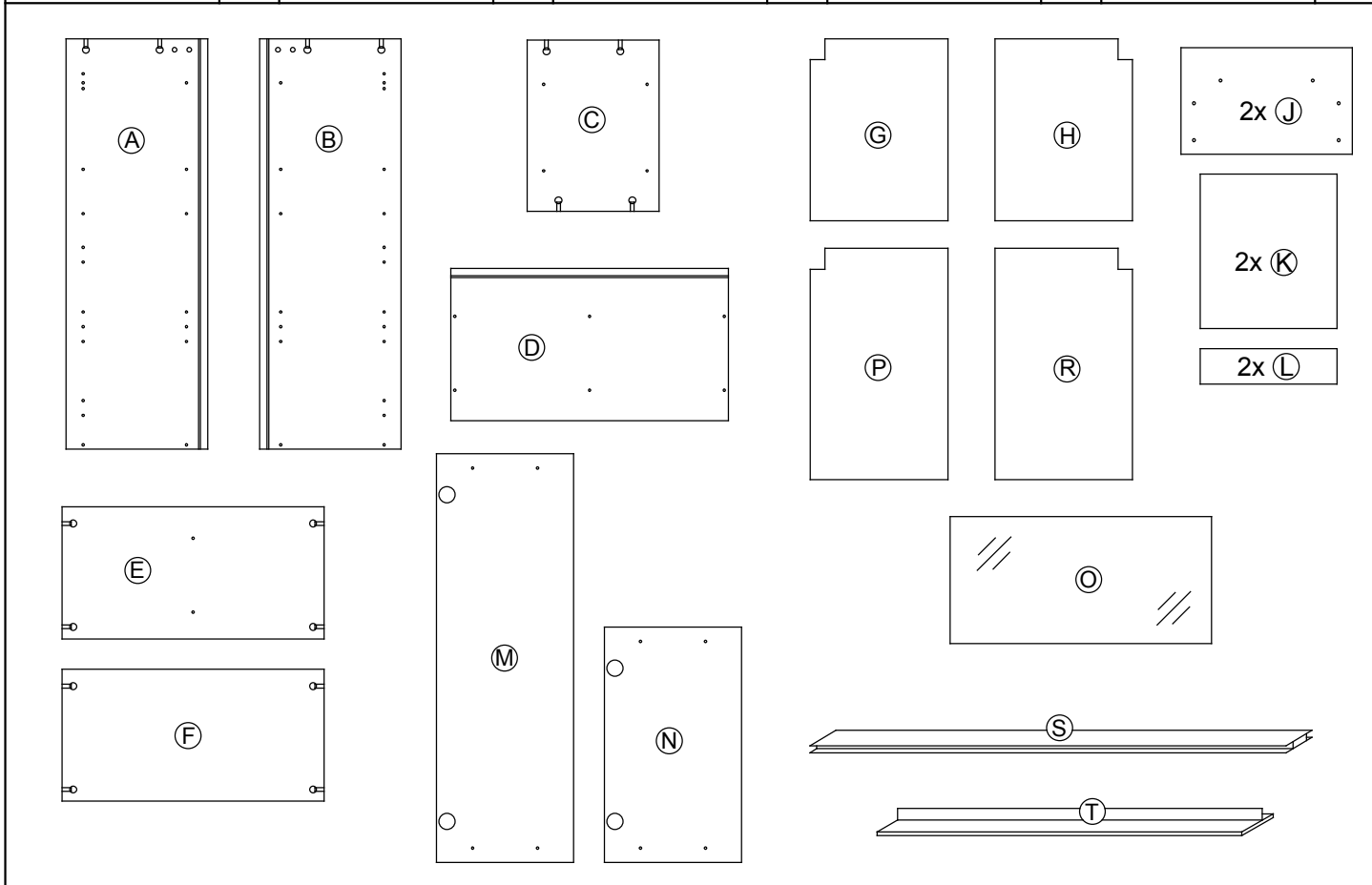

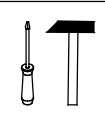
1. 

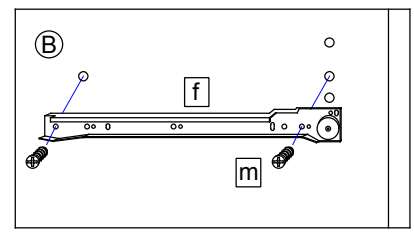
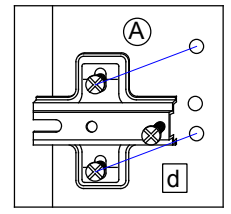
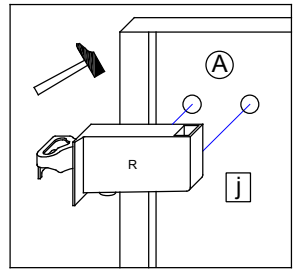
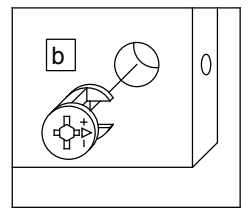
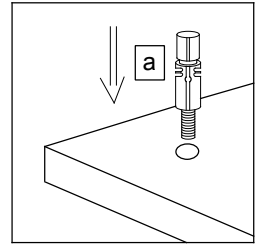
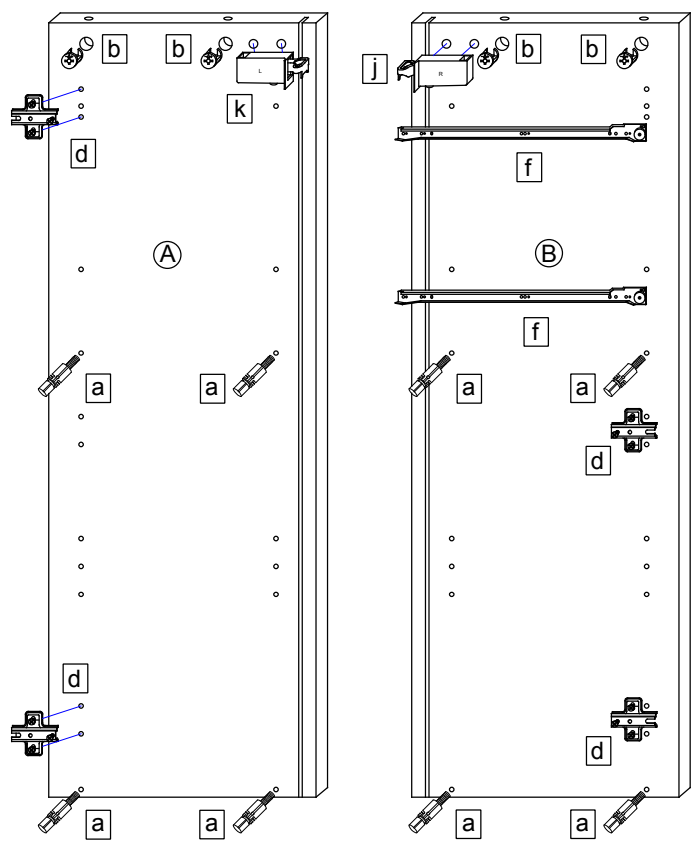

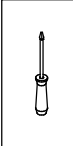
2. 

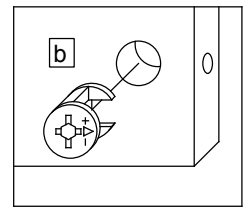
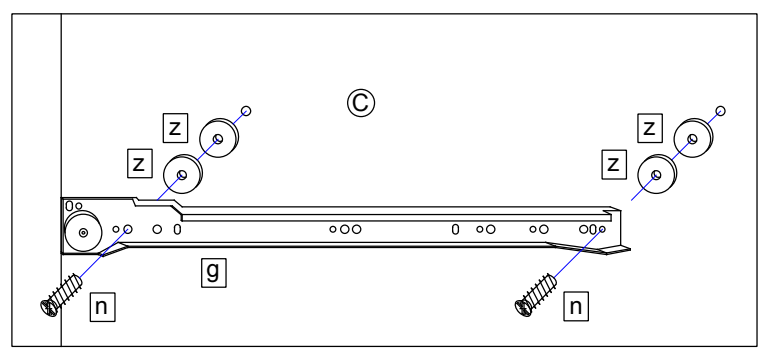
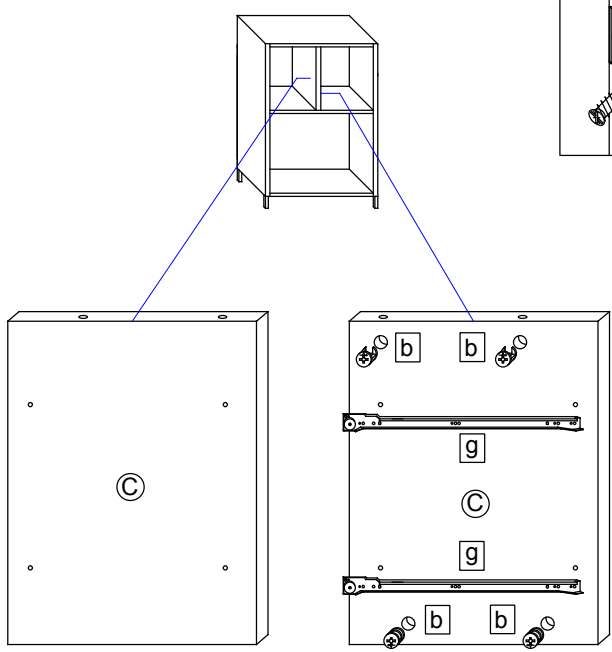

3.

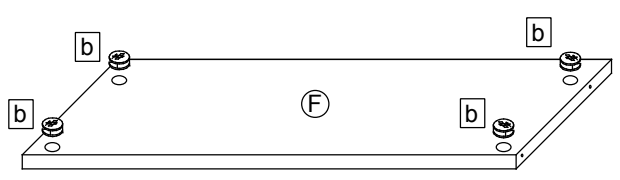
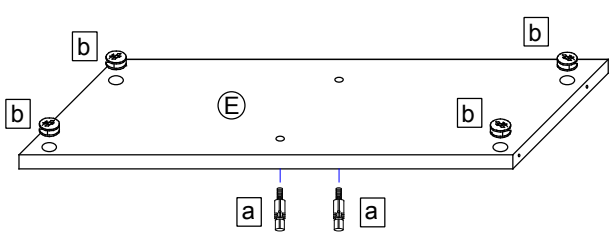
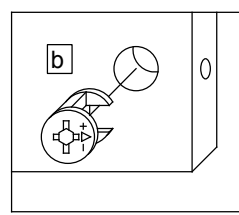
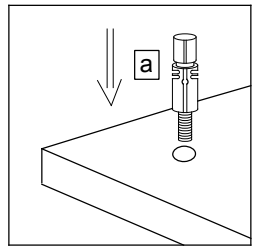
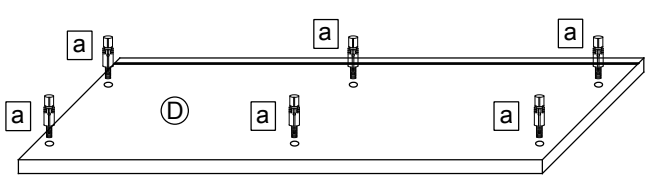
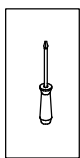

4.

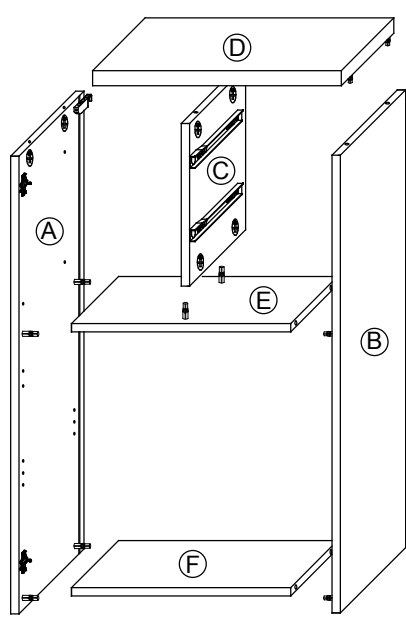
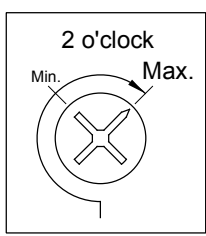
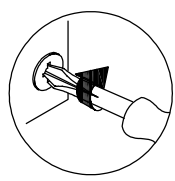
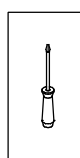

5.

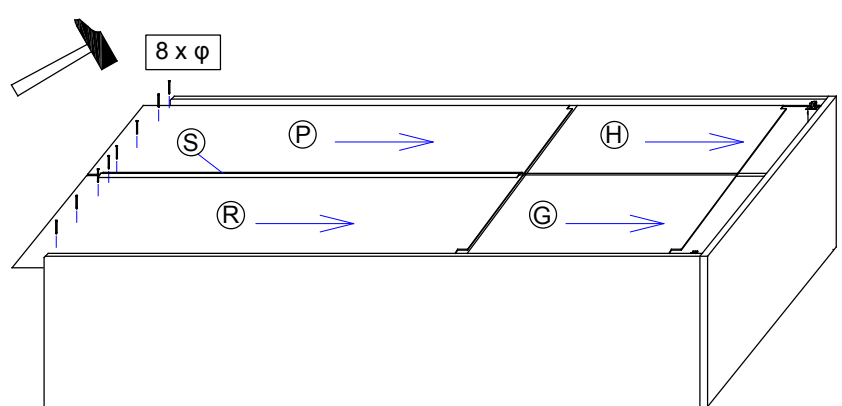
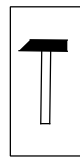

6.

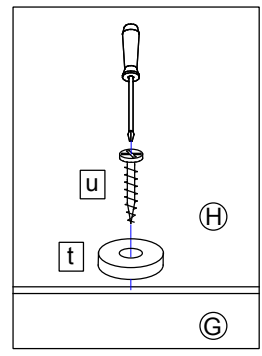
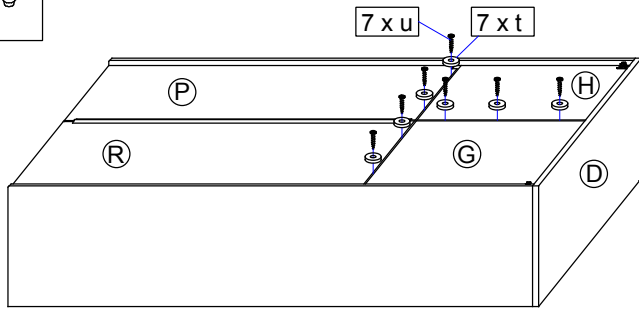
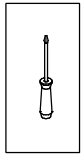

7.

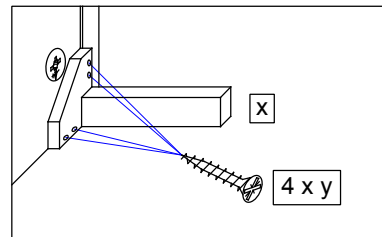
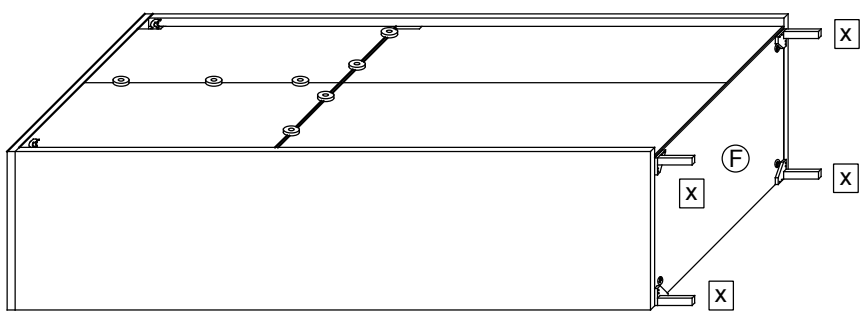
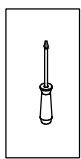

8.

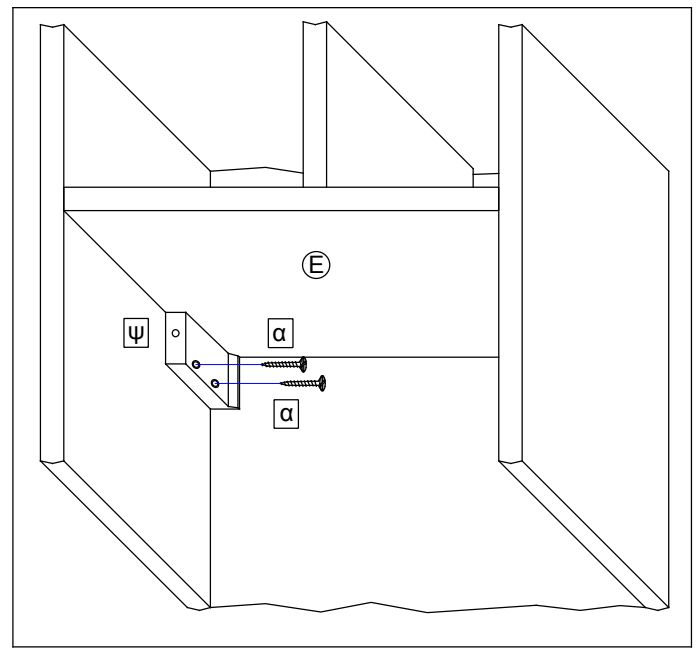
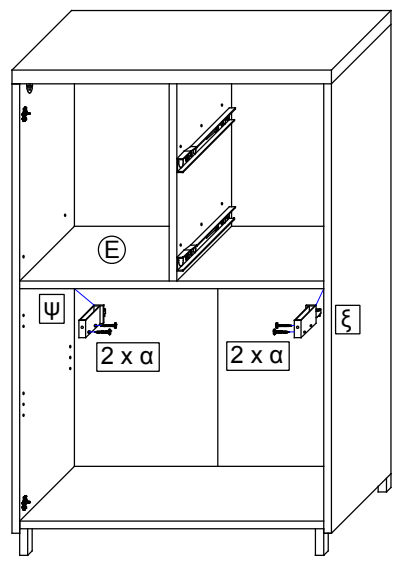
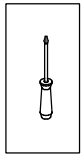

9.

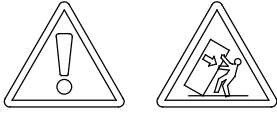
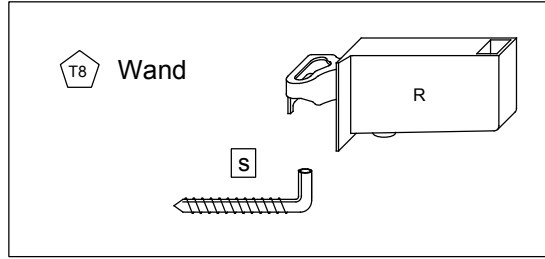
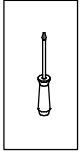

T9

Lassen Sie den Schrank nur durch fachkundige Personen mit für die Wand geeignetem Montagematerialien montieren.

T6

Die Schrankaufhänger dienen zur Kippsicherung des Schrankes und müssen grundsätzlich montiert werden.

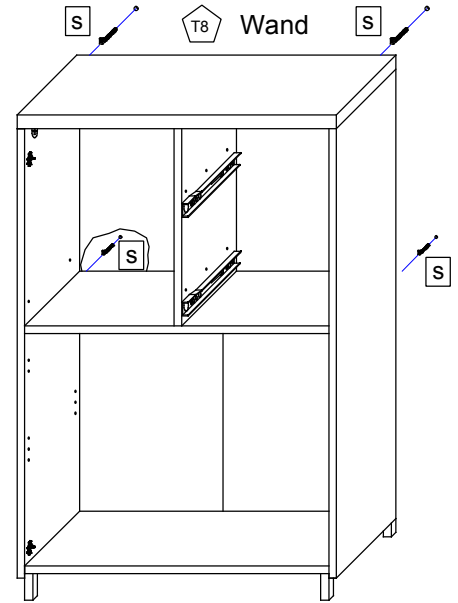
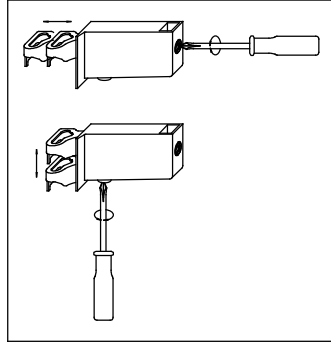

10.

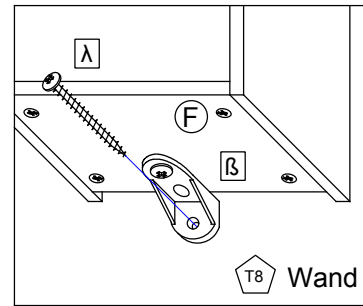
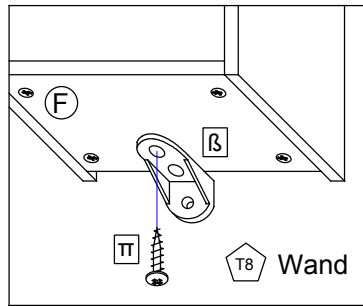
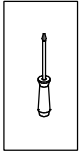

11.

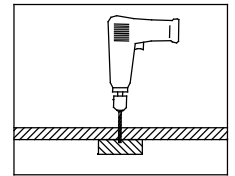
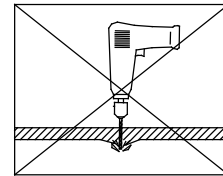
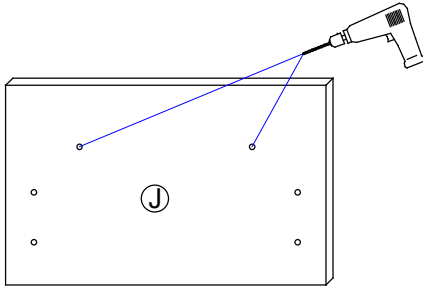
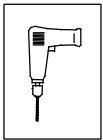

12.

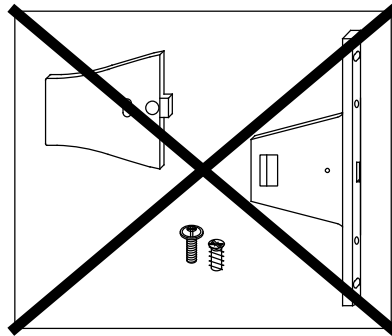
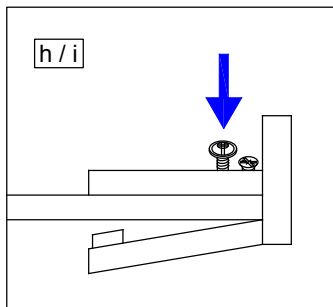
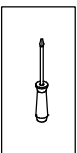

12.2

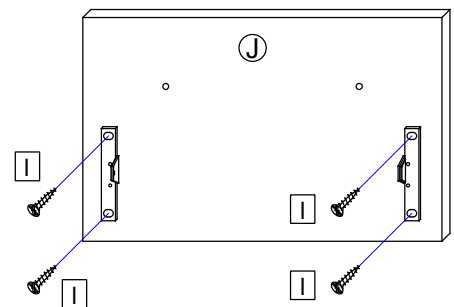

12.1

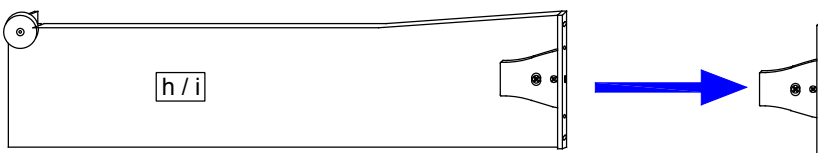

13.

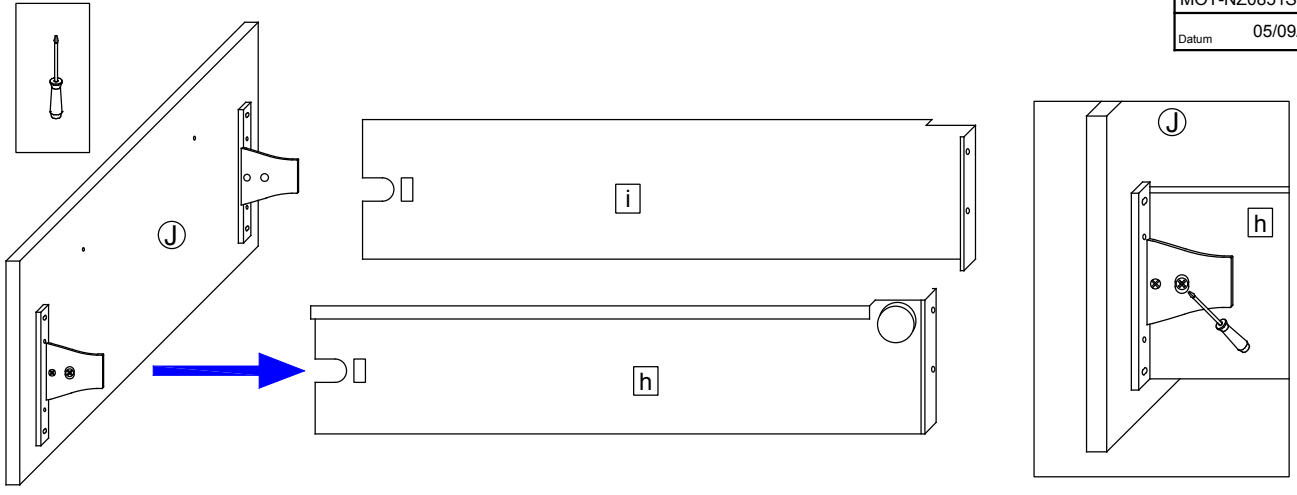

14.

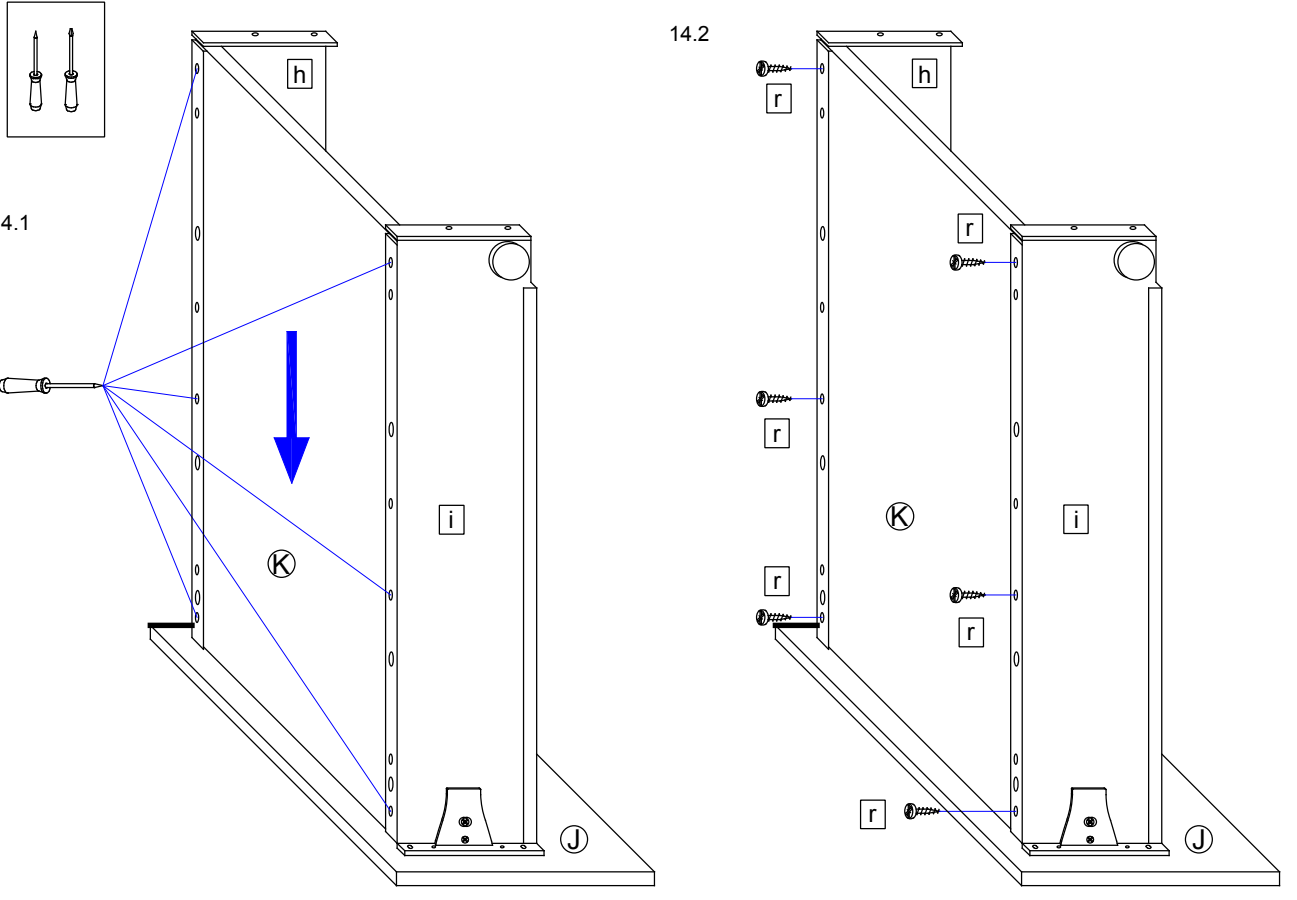

15.

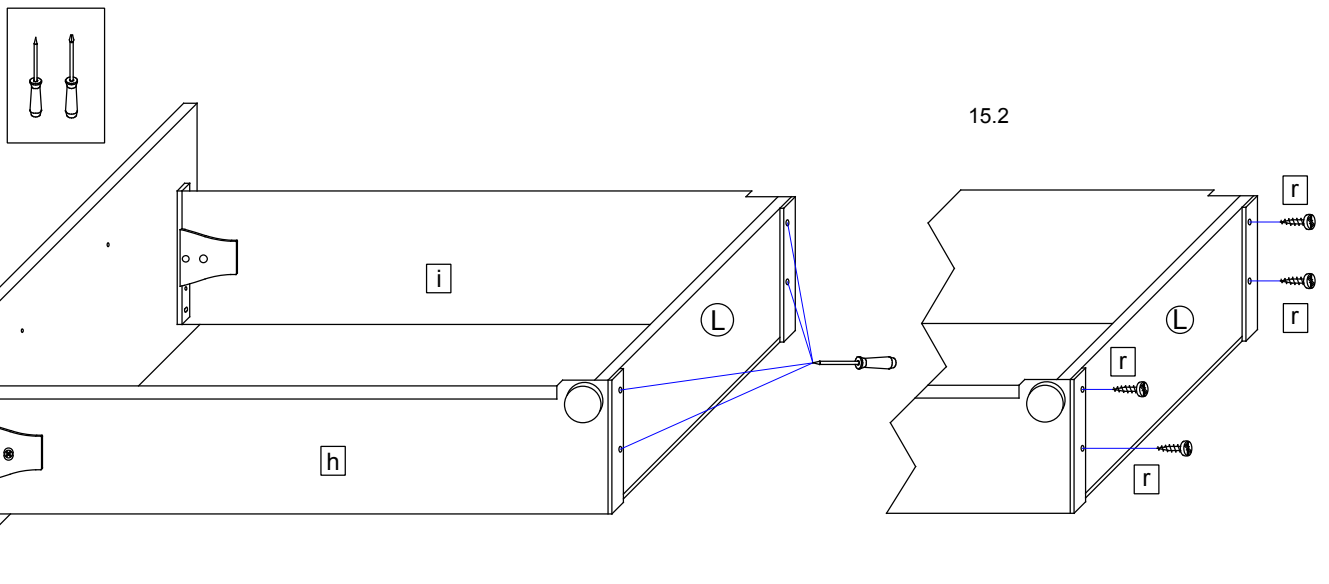

16.

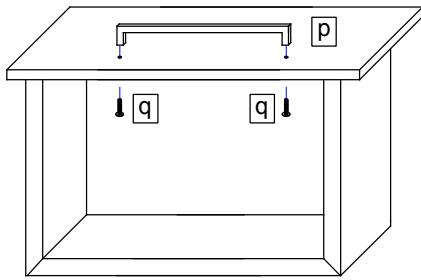
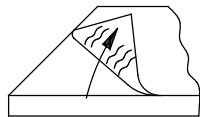
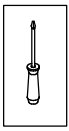

Bei Hochglanz-Fronten bitte erst die Schutzfolie entfernen und dann den Griff montieren!

17.

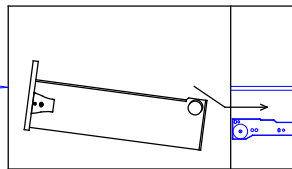
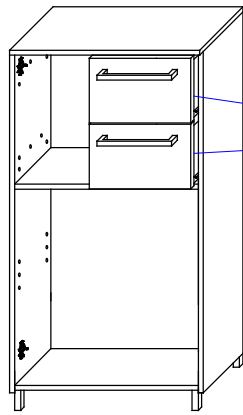

18.

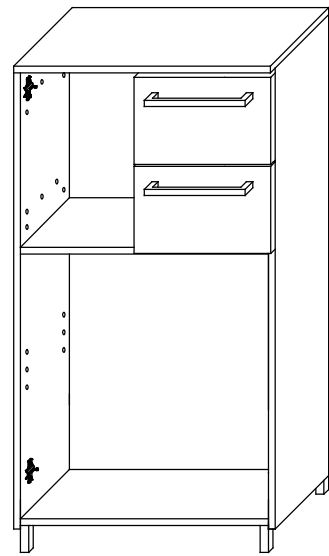
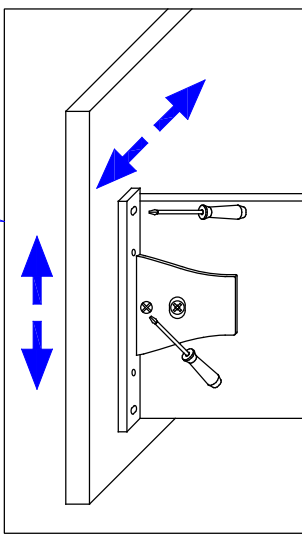
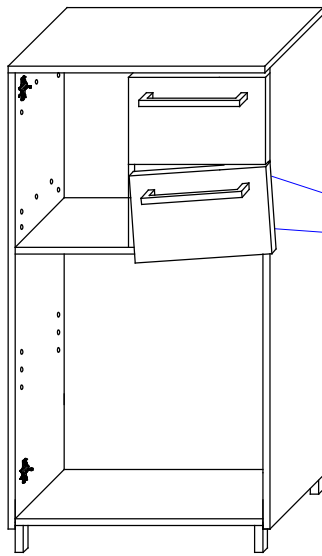
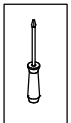

19.

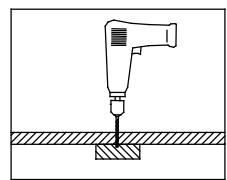
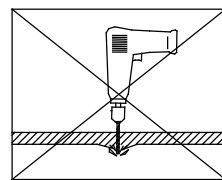
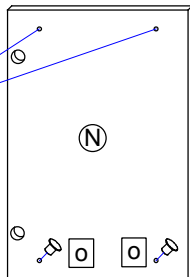
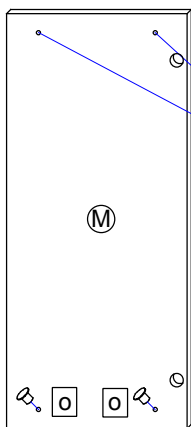

20.

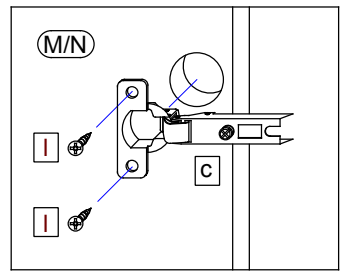
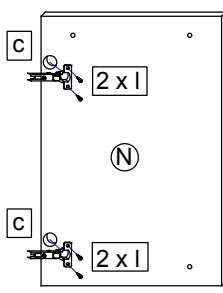
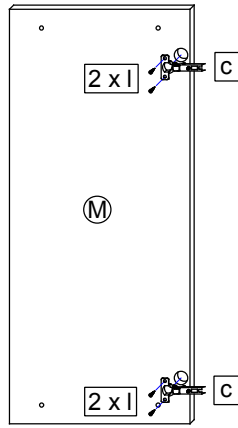
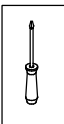

21.

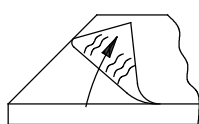
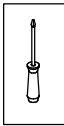

T10

Bei Hochglanz-Fronten bitte erst die Schutzfolie entfernen und dann den Griff montieren!

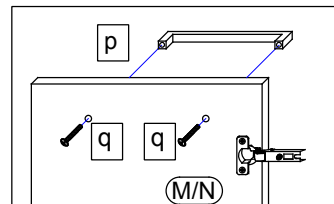

22.

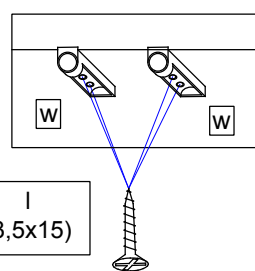
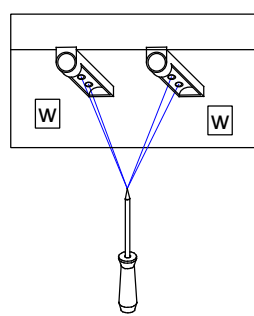
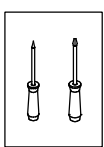

l
(3,5x15)

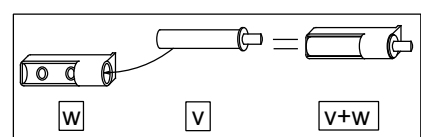

T11

Bei Türmontage das Scharnier einhängen, bis Anschlag öffnen und anschließend festschrauben.

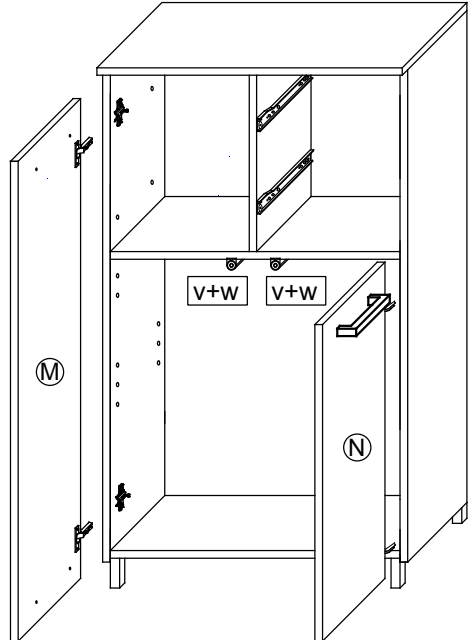
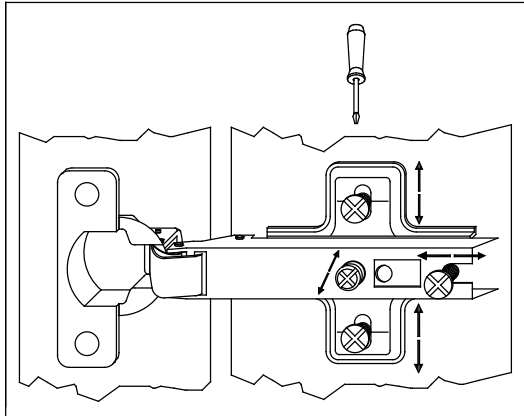
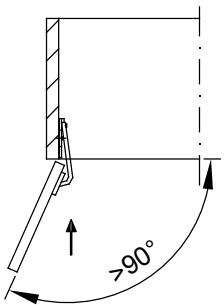

23.

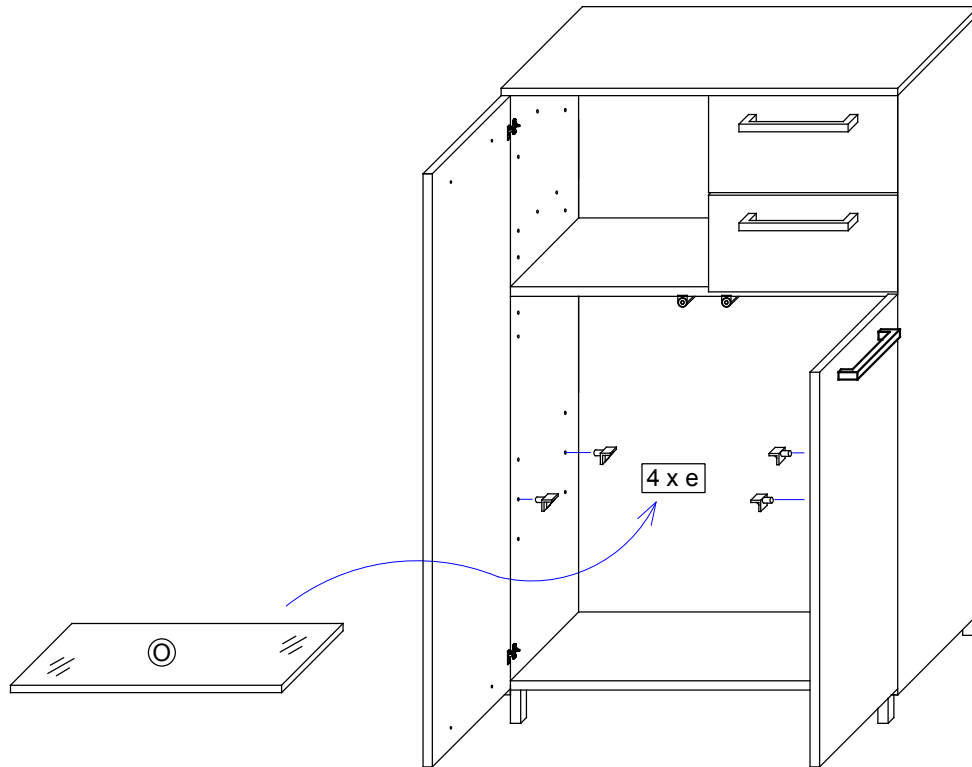

24.

