

**INSTRUCTION MANUAL/BEDIENUNSANLEITUNG / NOTICE D'UTILISATION/  
MANUAL DE INSTRUCCIONES DE USO/MANUALE DI ISTRUZIONI/NAVODILA ZA UPORABO**

**! WARNING**

Adults assembly required. During assembly, keep all parts away from children. Check regularly to ensure all fasteners are tight.

**! WARNUNG**

Die Montage ist von Erwachsenen durchzuführen. Halten Sie während der Montage alle Teile von Kindern fern. Überprüfen Sie regelmäßig den festen Sitz der Schrauben.

**! Attention !**

Montage à effectuer par des adultes. Pendant le montage, tenez les éléments éloignés des enfants. Vérifiez régulièrement que toutes les vis soient serrées.

**! ¡Atención!**

Se requiere que el montaje sea llevado a cabo por un adulto. Durante el montaje, mantenga todas las piezas fuera del alcance de los niños. Verifique regularmente que todos los tornillos estén correctamente apretados.

**! avvertimento**

L'assemblaggio deve essere effettuato da adulti. Durante il montaggio mantenere tutti i pezzi lontano dalla portata dei bambini. Controllare regolarmente per assicurarsi che tutte le chiusure siano ben strette.



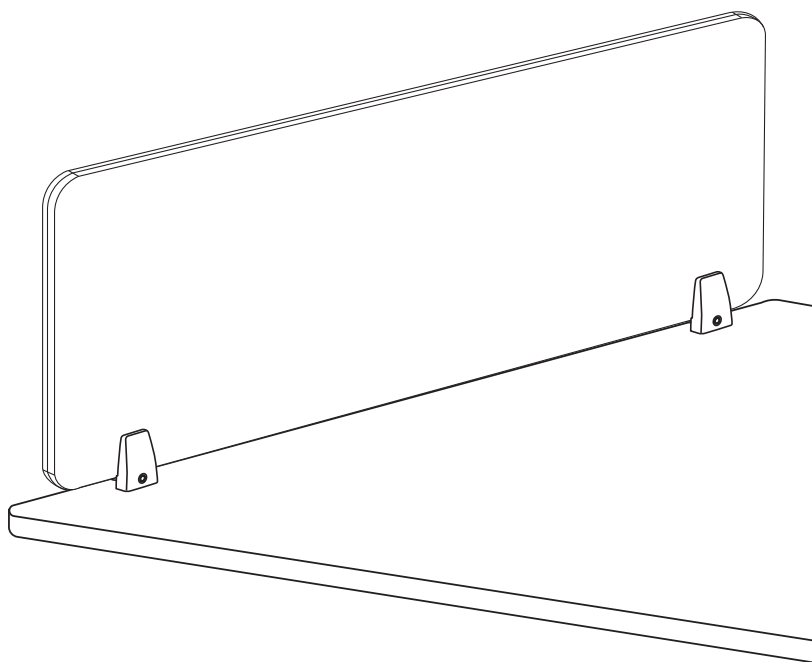

**! POZOR**

Potrebna montaža odraslih. Med sestavljanjem hranite vse dele izven dosega otrok. Redno preverjajte, ali so vsi pritrdilni elementi tesni.

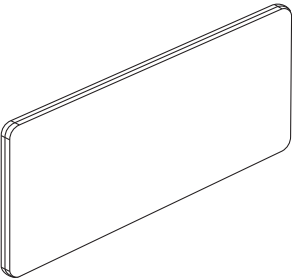
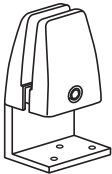

**RETAIN FOR FUTURE REFERENCE  
FÜR KÜNFTIGE VERWENDUNG AUFBEWAHREN  
A CONSERVER POUR UNE UTILISATION FUTURE  
CONSERVAR PARA SER LEÍDO POR CADA NUEVO USUARIO,  
ANTES DE UTILIZAR EL ARTÍCULO POR PRIMERA VEZ  
CONSERVARE PER CONSULTAZIONI FUTURE  
SHRANITE ZA KASNEJŠO UPORABO**

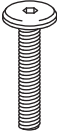
PARTS LIST/STÜCKLISTE/PARTS LIST/LISTA DE PIEZAS/LISTA DEI PEZZI/SEZNAM DELOV

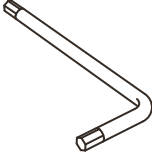
<p>A</p>  <p>1pc</p>	<p>B</p>  <p>2pcs</p>	<p>C</p>  <p>4pcs</p>
<p>D</p>  <p>M6x30</p> <p>2pcs</p>	<p>E</p>  <p>M6x16</p> <p>6pcs</p>	<p>F</p>  <p>1pc</p>

ASSEMBLY/MONTAGE/ASSEMBLAGE/MONTAJE/ASSEMBLAGGIO/MONTAŽA

