

# MELVIN LUX 3 DL

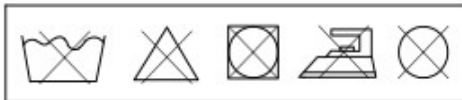

D – Montageanleitung GB – Assembly instructions NL – Rondleiding voor de montage PL – Instrukcja montażu TR – Montaj talimatı  
RO – Instrucțiuni de montaj IT – Istruzioni di montaggio FR – Notice de montage SK – Navod na montá CZ – Montážní návod  
HU – Szerelési utmutató RU – Инструкция по монтажу

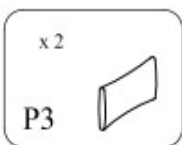
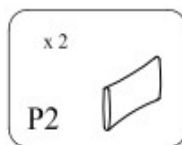
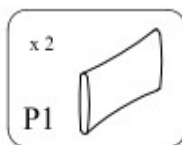
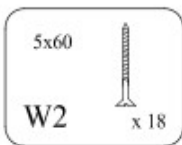
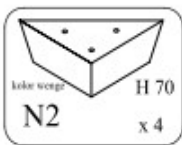

**1**

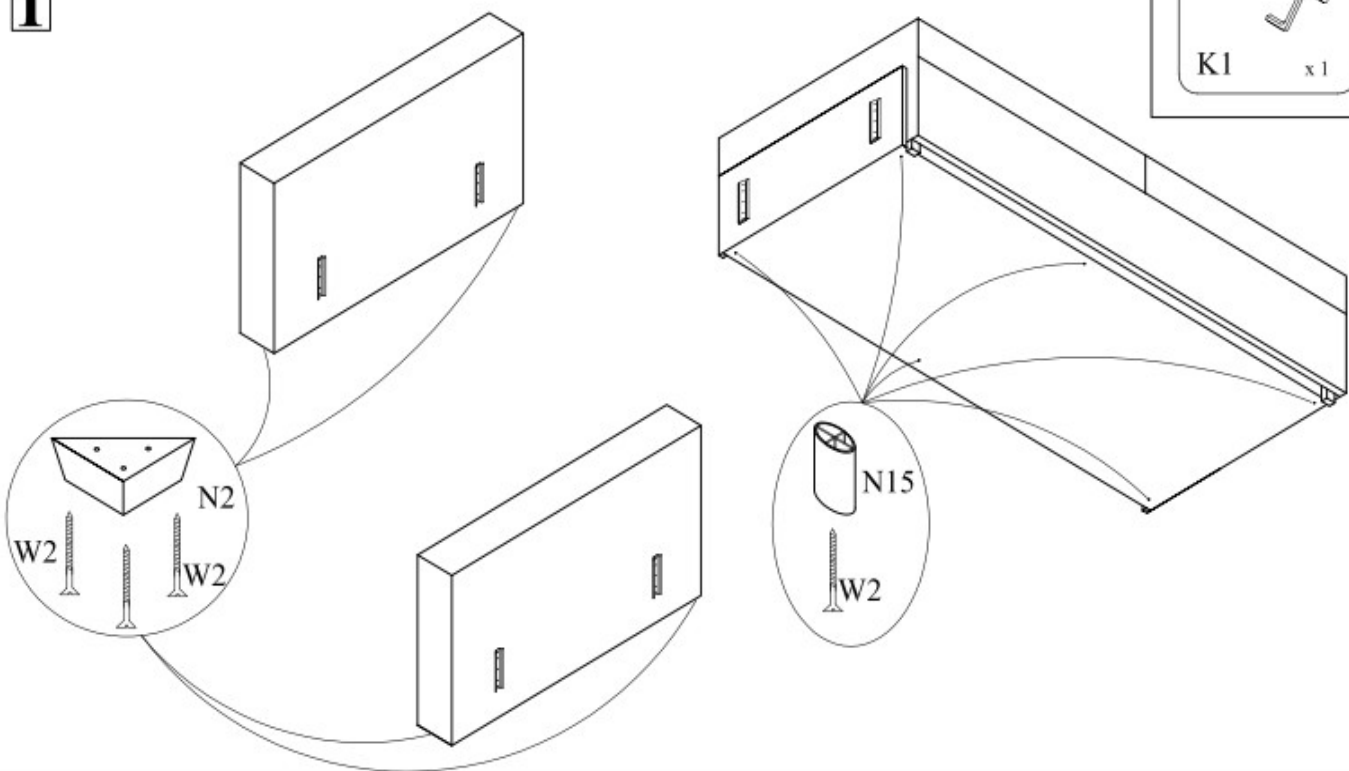

**2**

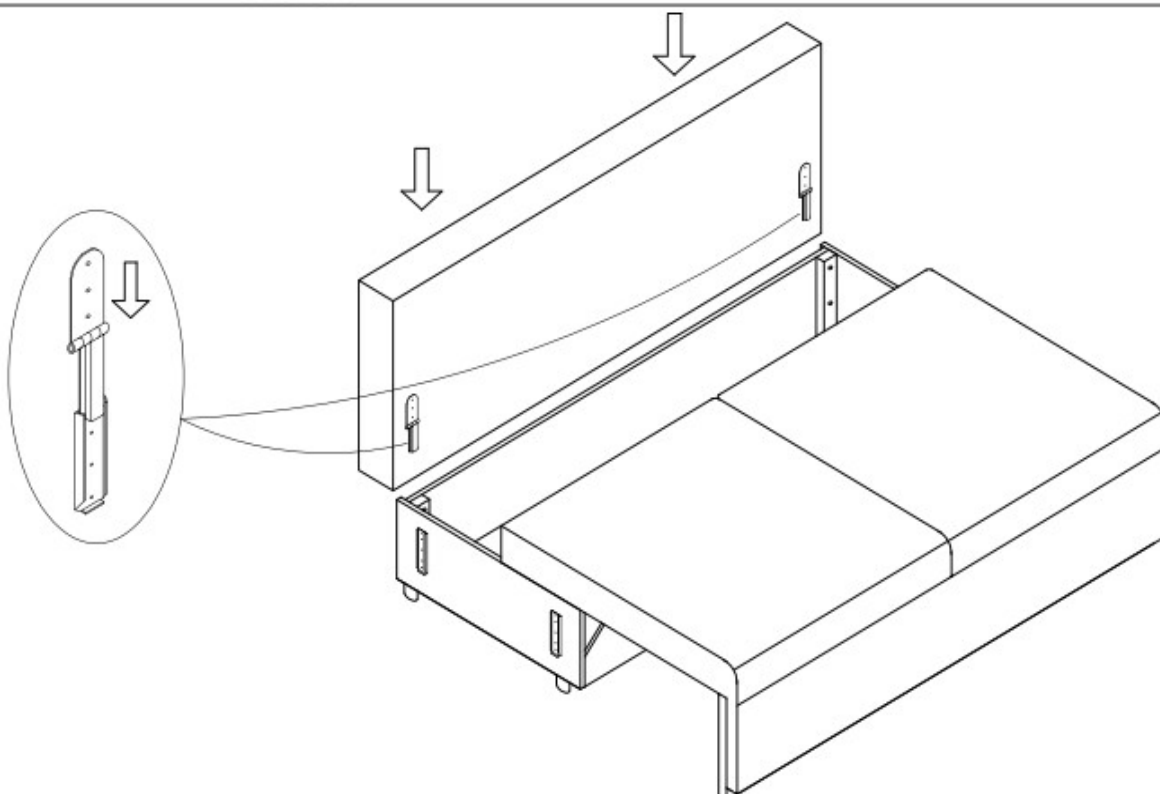

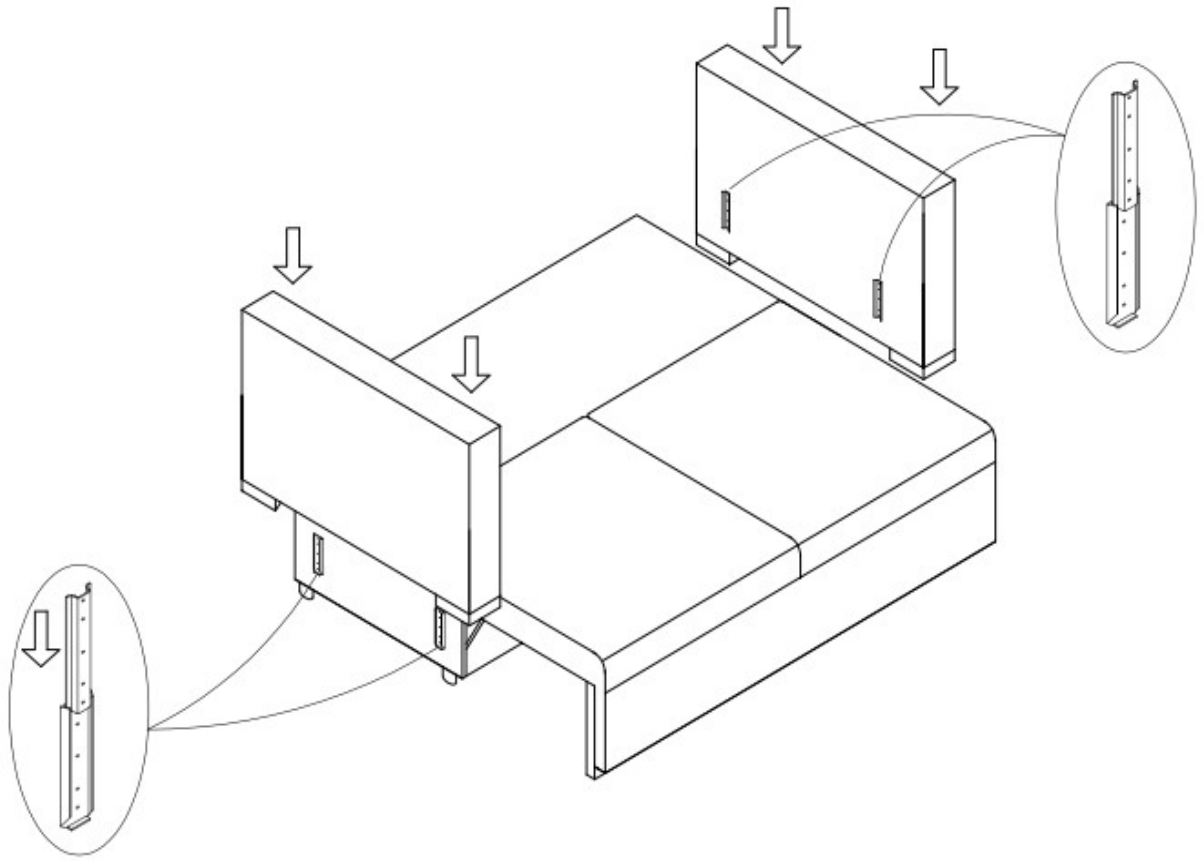
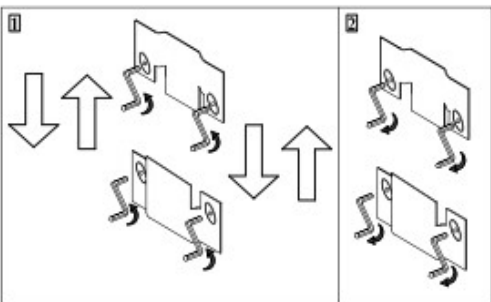
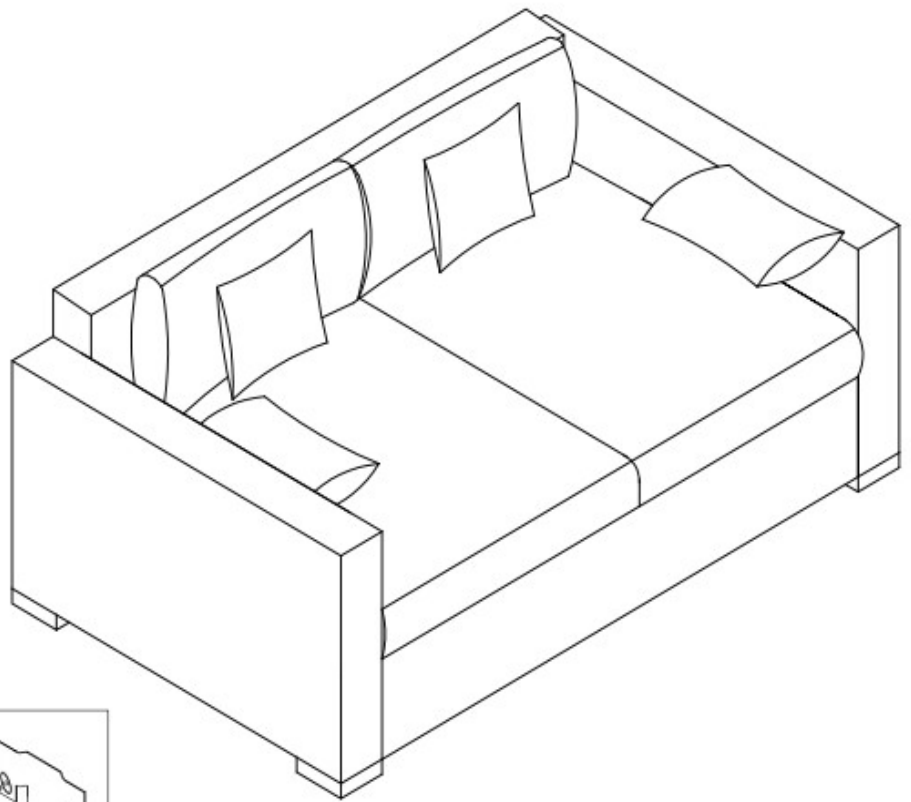
**3****4**

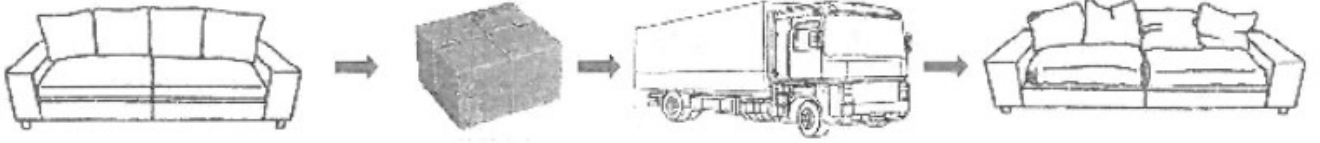

1

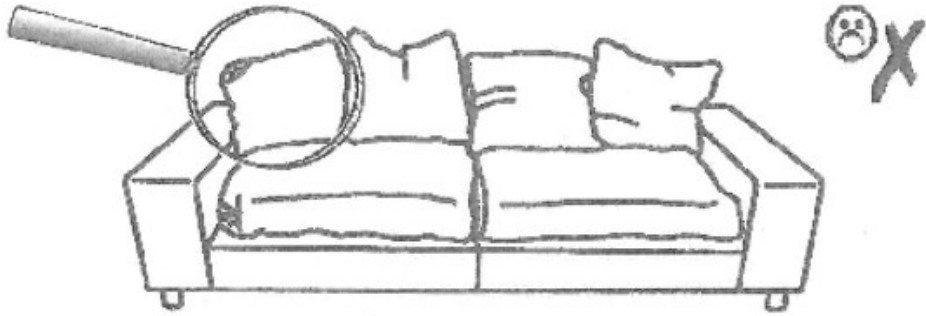

2

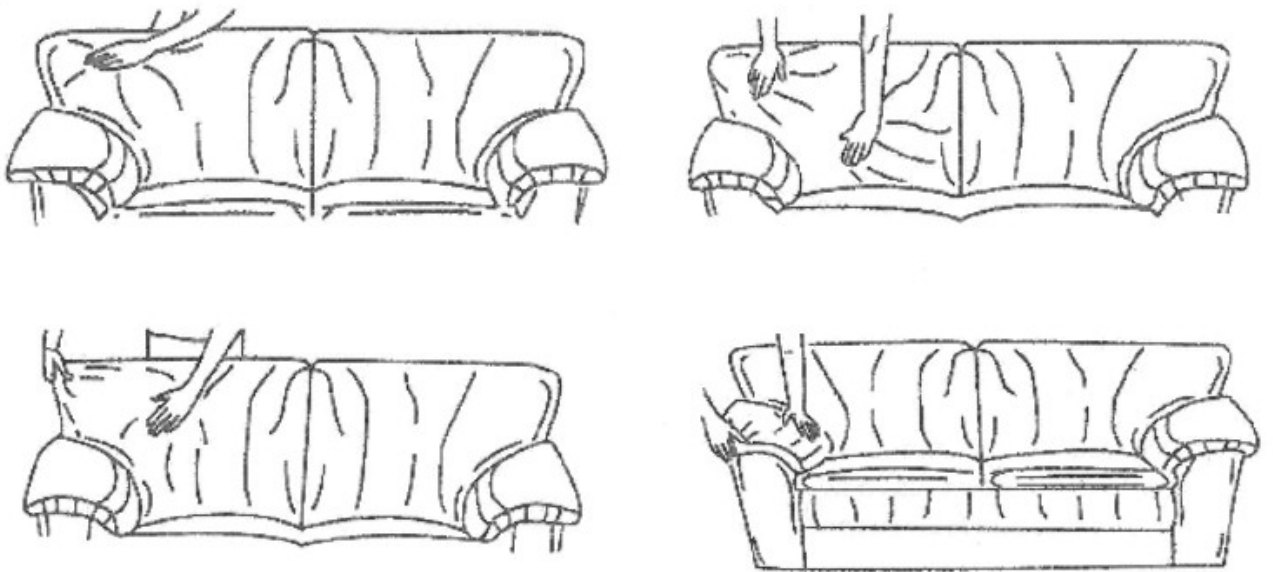

3

