

# MONTAGEINSTRUKTIONEN

## Bettrahmen

SKU: WF315574

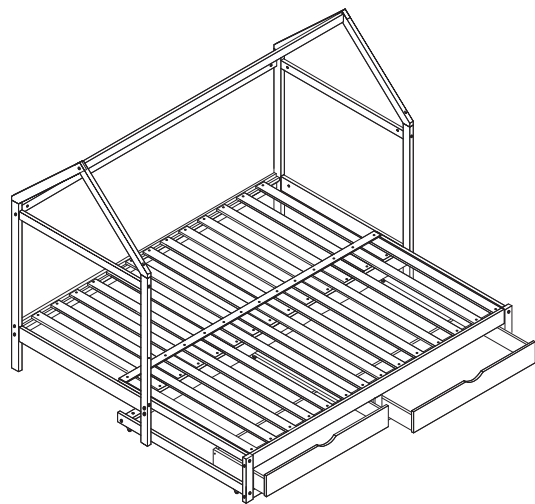

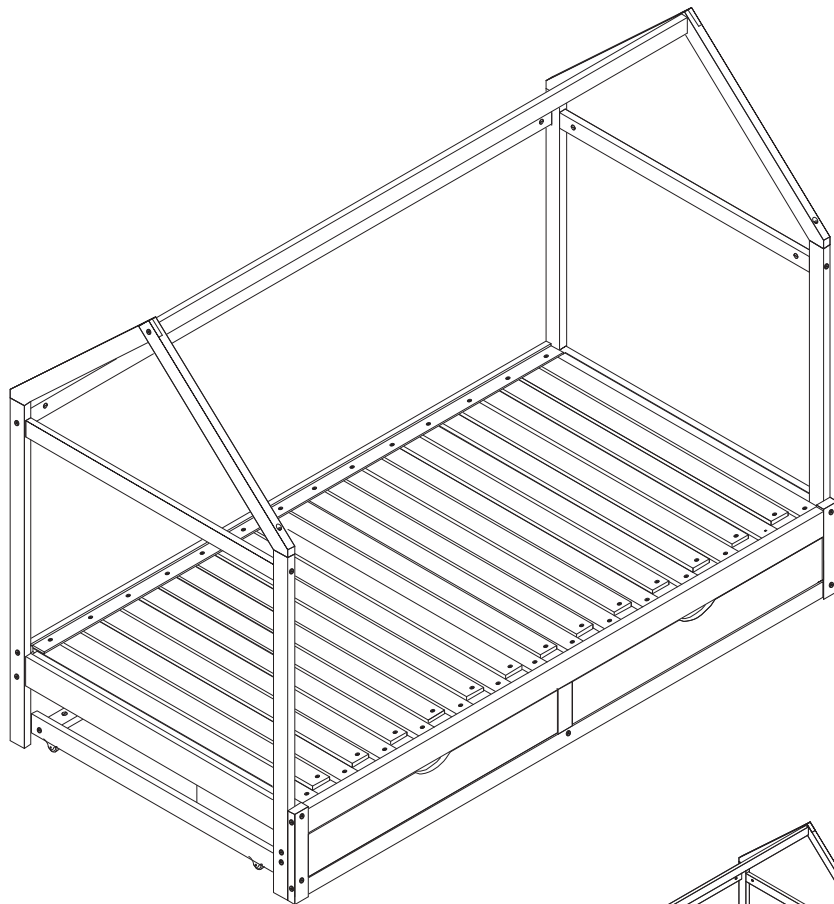



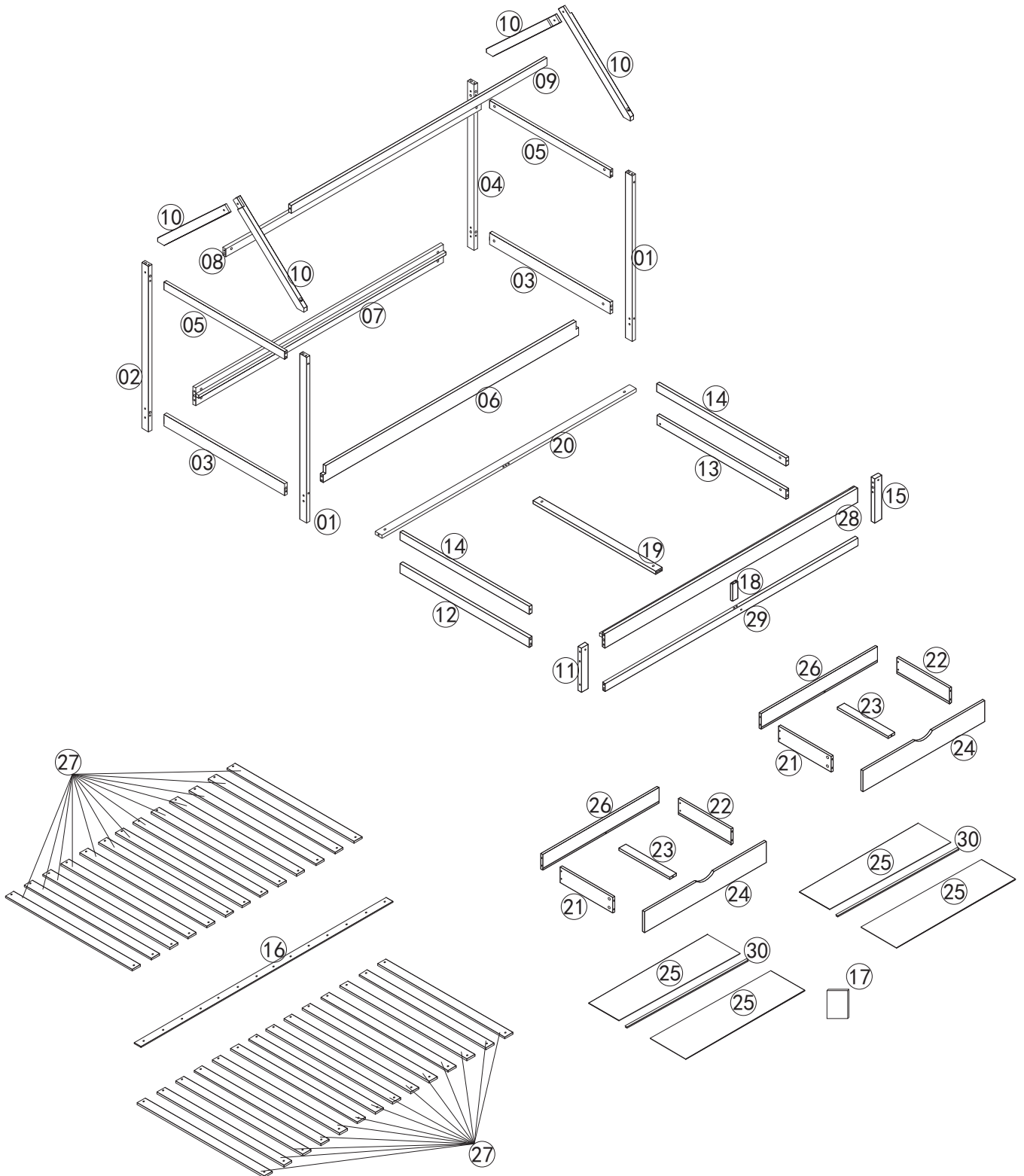





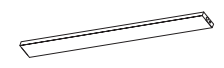

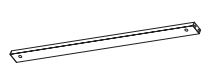

WF315575



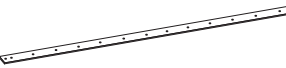









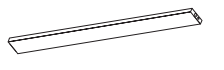
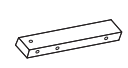

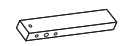
# Detailansicht

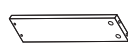









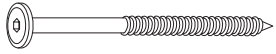

# WF315574

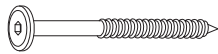
① x2 	② x1 	③ x1 	④ x1 
⑤ x2 	⑥ x1 	⑦ x1 	⑧ x1 
⑨ x1 	⑩ x4 	⑭ x2 	⑰ x1 
⑰ x1 	⑲ x1 	⑳ x1 	㉘ x1 
㉙ x1 			

# WF315575

③ x1 	⑪ x1 	⑫ x1 	⑬ x1 
⑮ x1 	⑱ x1 	㉑ x2 	㉒ x2 
㉓ x2 	㉔ x2 	㉕ x4 	㉖ x2 
㉗ x27 	㉘ x2 		

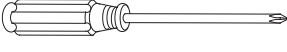
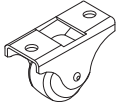
# WF315574





<b>A</b> 	<b>B</b> 	<b>C</b> 
$\Phi 6 \times 90 \text{mm}$ (13 pcs)	$\Phi 10 \times 13 \text{mm}$ (32 pcs)	$\Phi 6 \times 70 \text{mm}$ (19 pcs)
<b>D</b> 	<b>E</b> 	<b>F</b> 
$\Phi 8 \times 30 \text{mm}$ (36 pcs)	$\Phi 6 \times 80 \text{mm}$ (4 pcs)	(2 pcs)
<b>G</b> 	<b>H</b> 	<b>I</b> 
$\Phi 4 \times 30 \text{mm}$ (52 pcs)	$\Phi 3.5 \times 12 \text{mm}$ (28 pcs)	M4 (1 pc )
<b>J</b> 	<b>K</b> 	<b>L</b> 
(1 pc)	(6 pcs)	(12 pcs)
<b>M</b> 		
(12 pcs)		

VERWENDEN SIE KEINE POWER TOOLS, um dieses Produkt zusammenzubauen!

Do not use power tools to assemble this product!



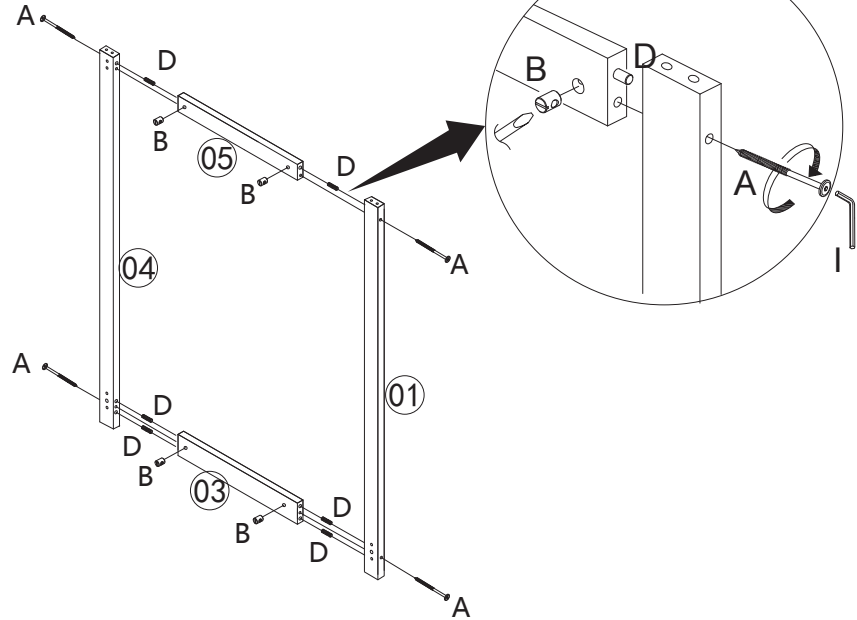
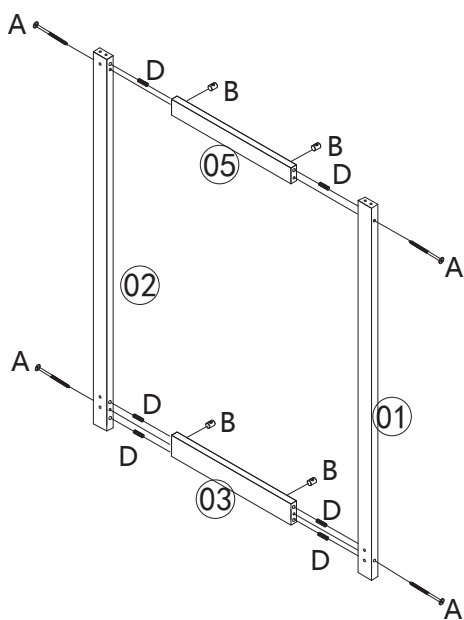

Anmerkung:  
Wir empfehlen Ihnen, Ihr Bett im flachen Boden zusammenzubauen  
Note:  
We recommend you to assemble your bed in flat floor

## SCHRITT 1:

<b>A</b>	<b>B</b>	<b>D</b>	<b>I</b>
			
8pcs	8pcs	12pcs	1pc



## SCHRITT 2:

<b>B</b>	<b>C</b>	<b>D</b>	<b>I</b>
			
10pcs	10pcs	4pcs	1pc

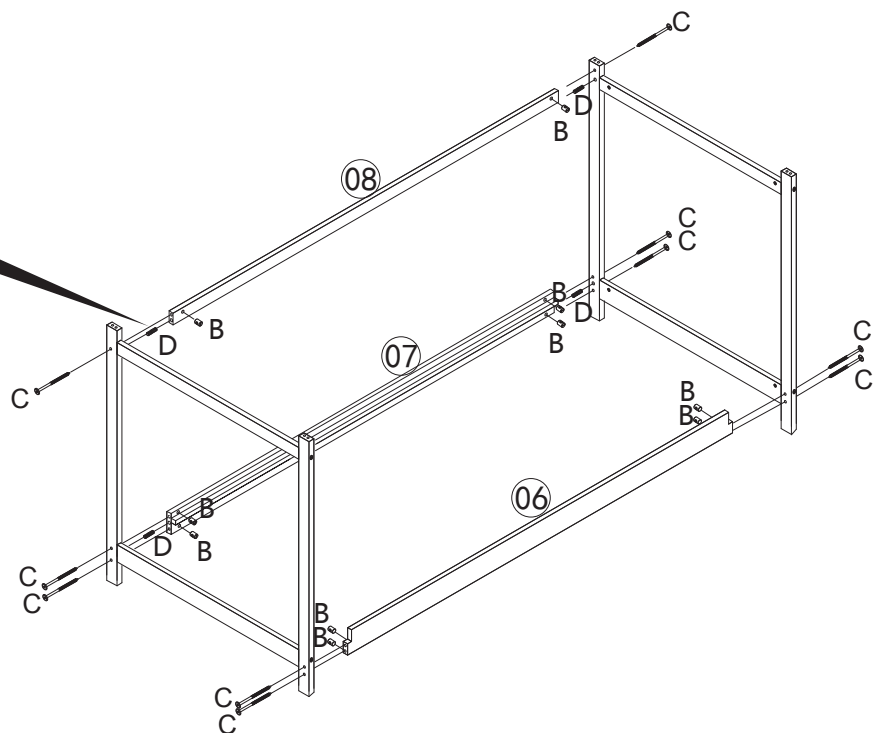
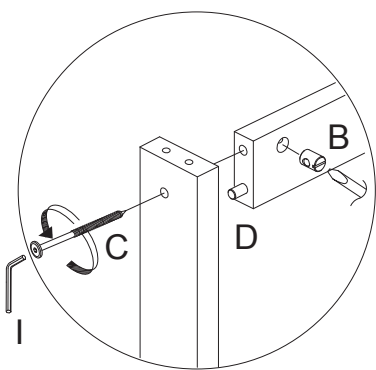



Anmerkung:

Wir empfehlen Ihnen, Ihr Bett im flachen Boden zusammenzubauen

Note:

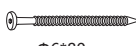

We recommend you to assemble your bed in flat floor

### SCHRITT 3:

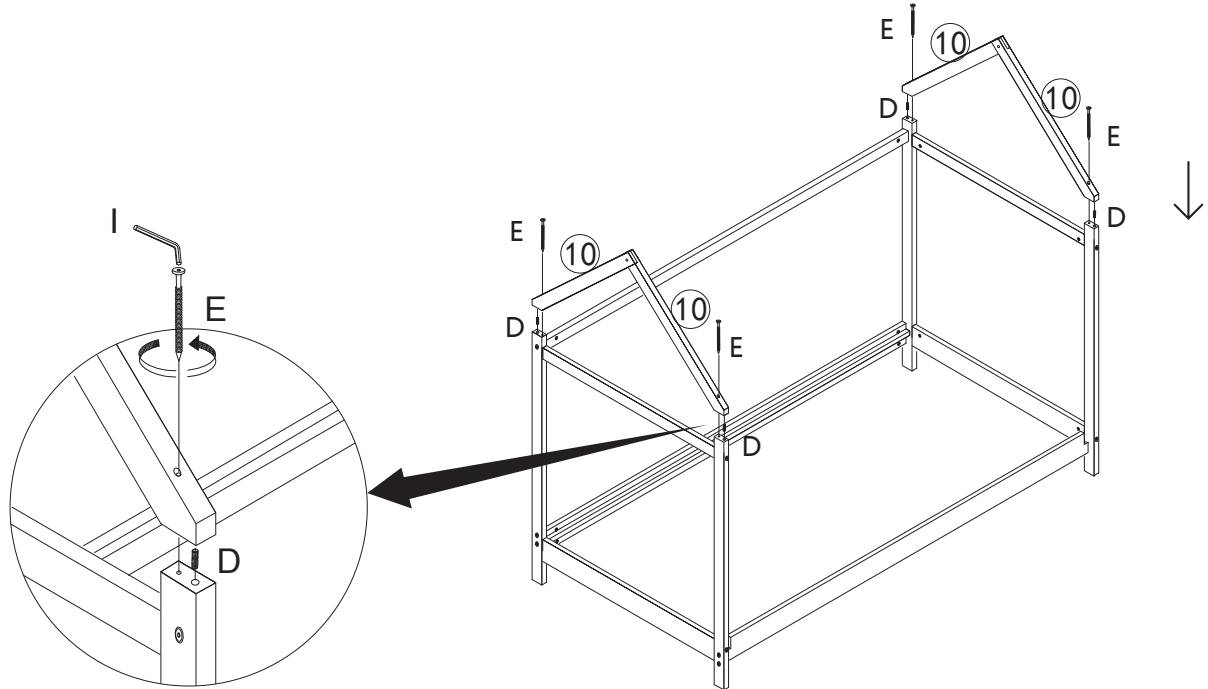
D	E	I
 Φ8*30mm	 Φ6*80mm	
4pcs	4pcs	1pc

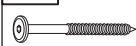

### SCHRITT 4:

B	C	I
 Φ10*13mm	 Φ6*70mm	
2pcs	2pcs	1pc

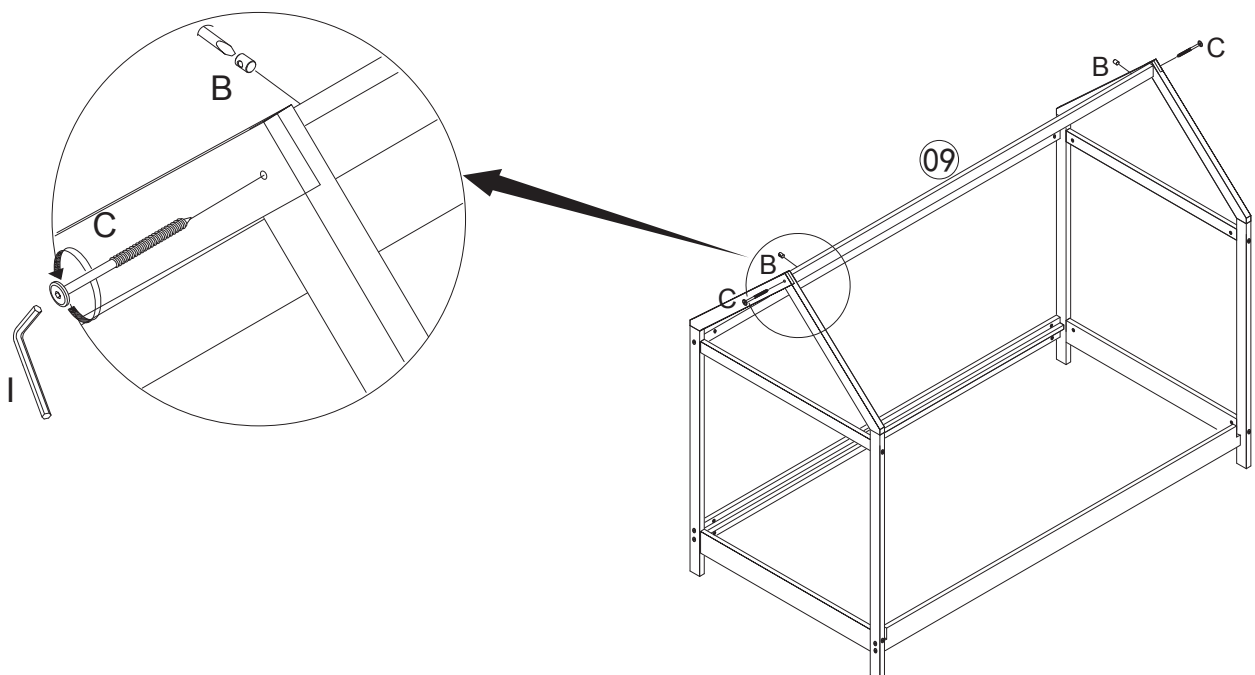





**Anmerkung:**

**Wir empfehlen Ihnen, Ihr Bett im flachen Boden zusammenzubauen**

Note:

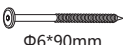

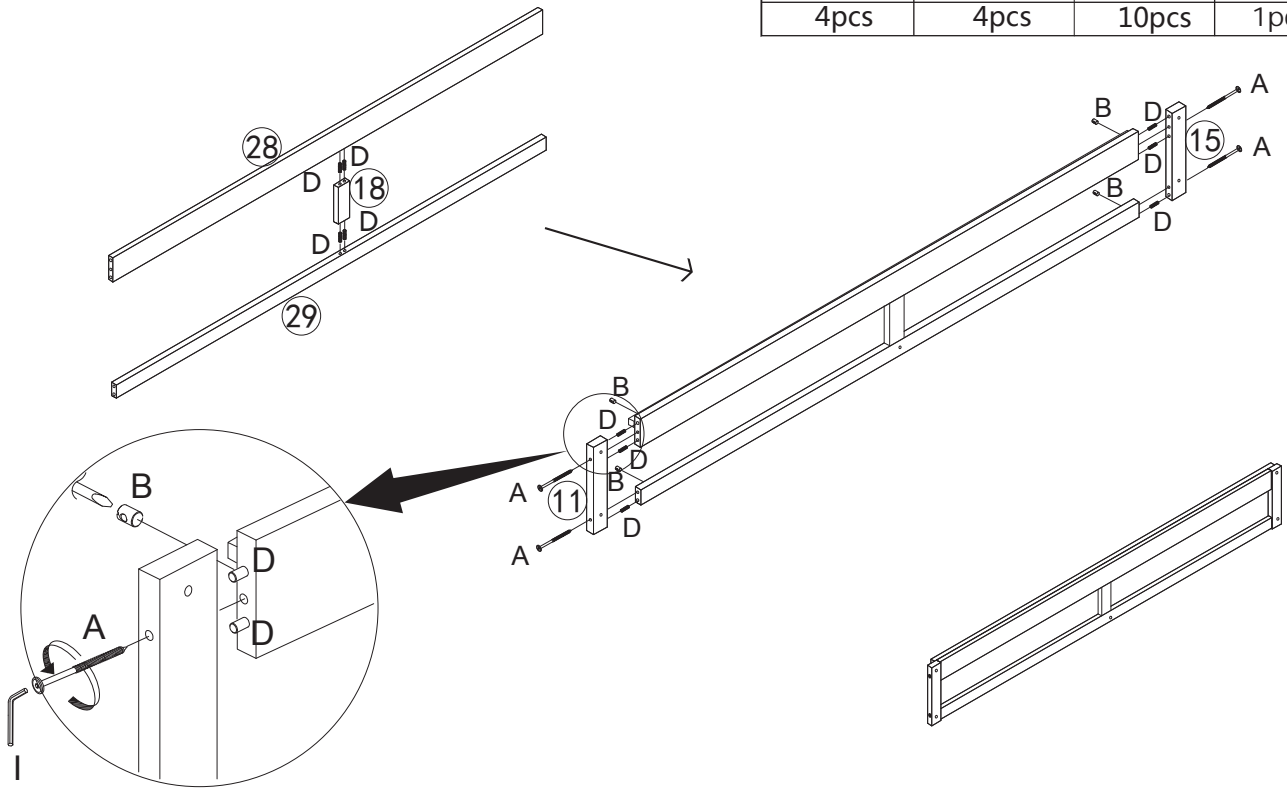

We recommend you to assemble your bed in flat floor

**SCHRITT 5:**

A	B	D	I
			
4pcs	4pcs	10pcs	1pc

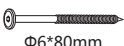

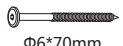
**SCHRITT 6:**

A	B	C	D	I
				
1pc	8pcs	7pcs	6pcs	1pc

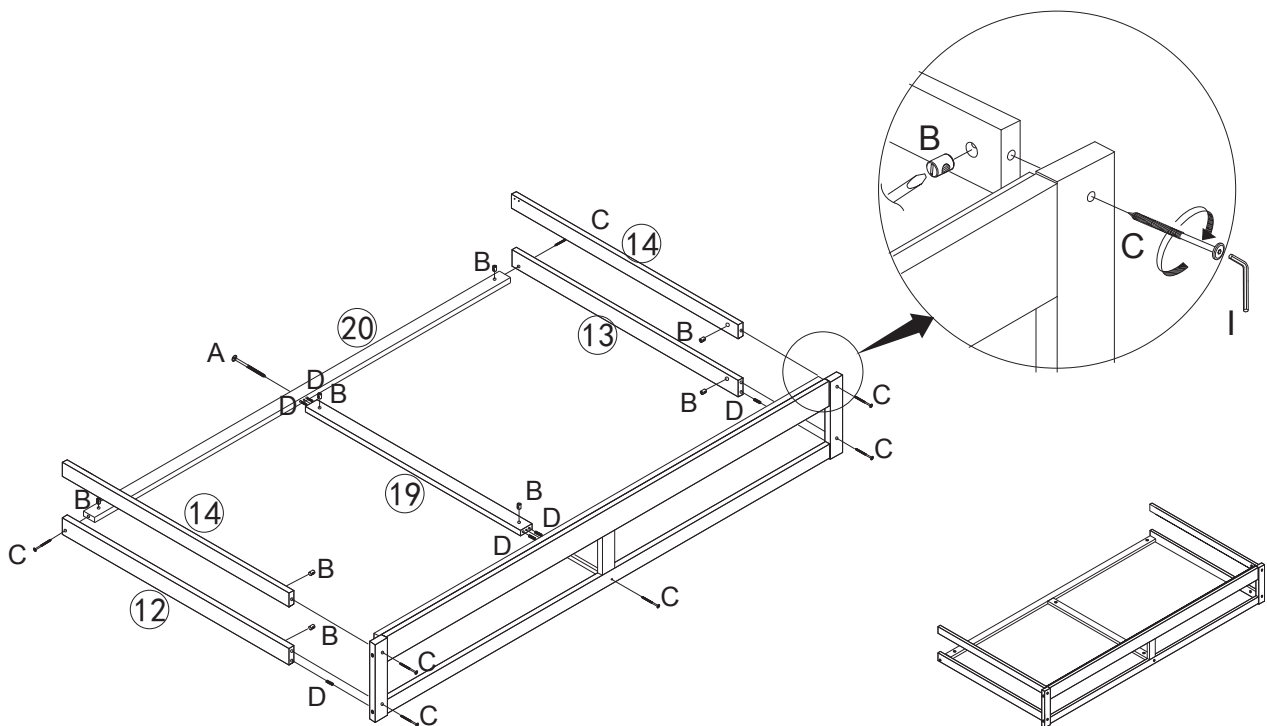



Anmerkung:

Wir empfehlen Ihnen, Ihr Bett im flachen Boden zusammenzubauen

Note:

We recommend you to assemble your bed in flat floor

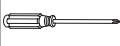
## SCHRITT 7:

H	J	K
 Φ3.5*12mm		
12pcs	1pc	6pcs

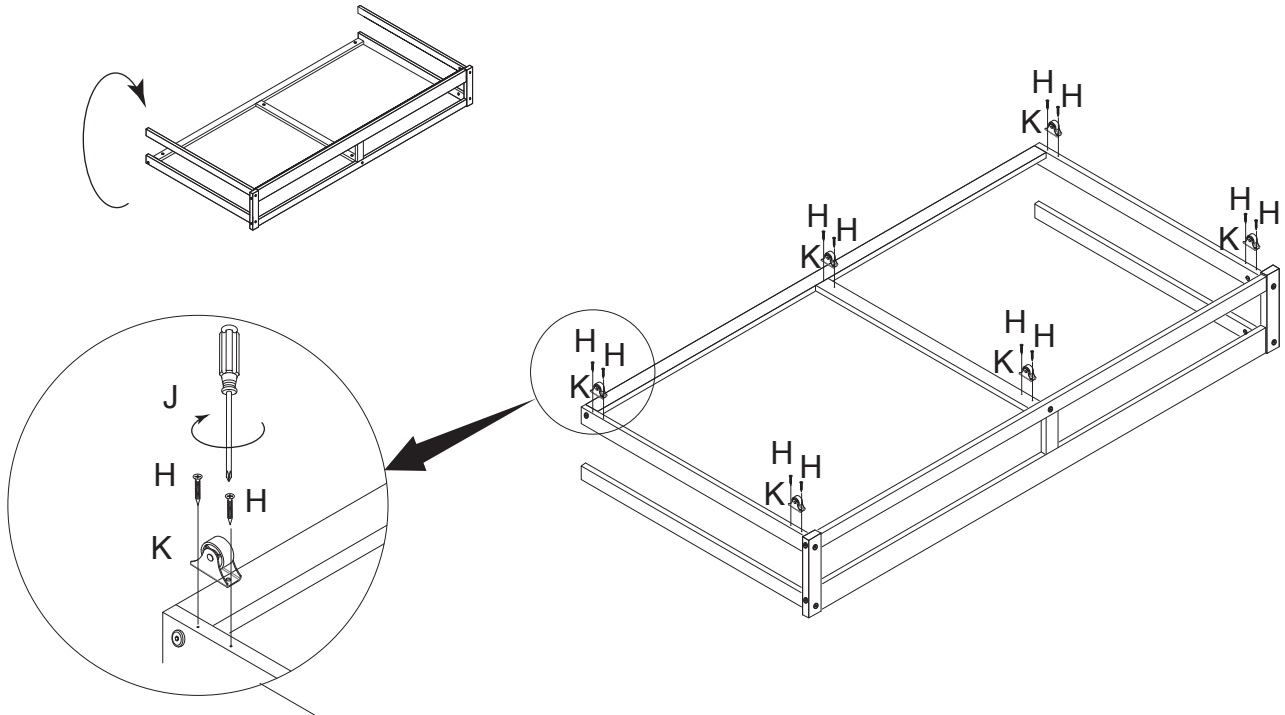

## SCHRITT 8:

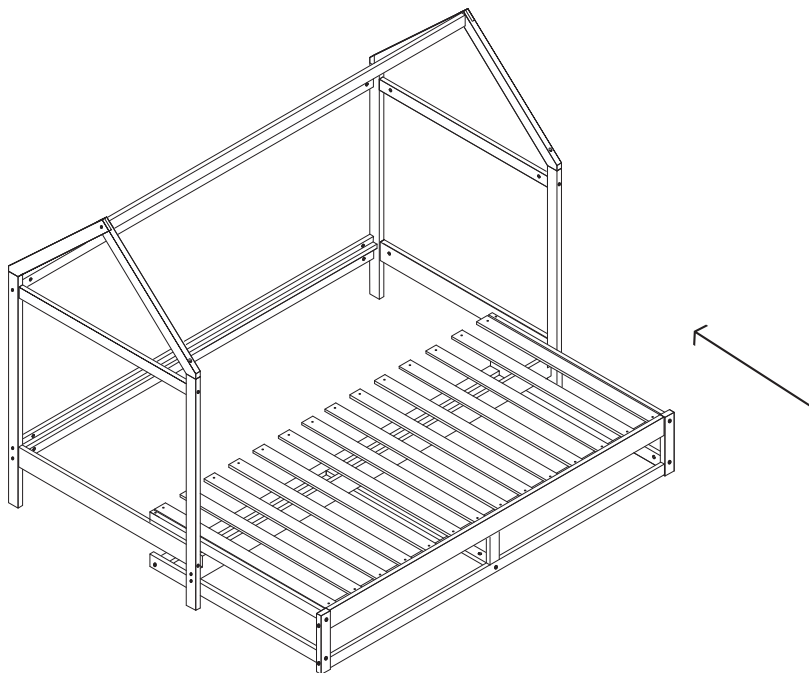





## Anmerkung:

Wir empfehlen Ihnen, Ihr Bett im flachen Boden zusammenzubauen

Note:

We recommend you to assemble your bed in flat floor

### SCHRITT 9:

G	H	J
 Φ4*30mm	 Φ3.5*16mm	
14pcs	16pcs	1pc

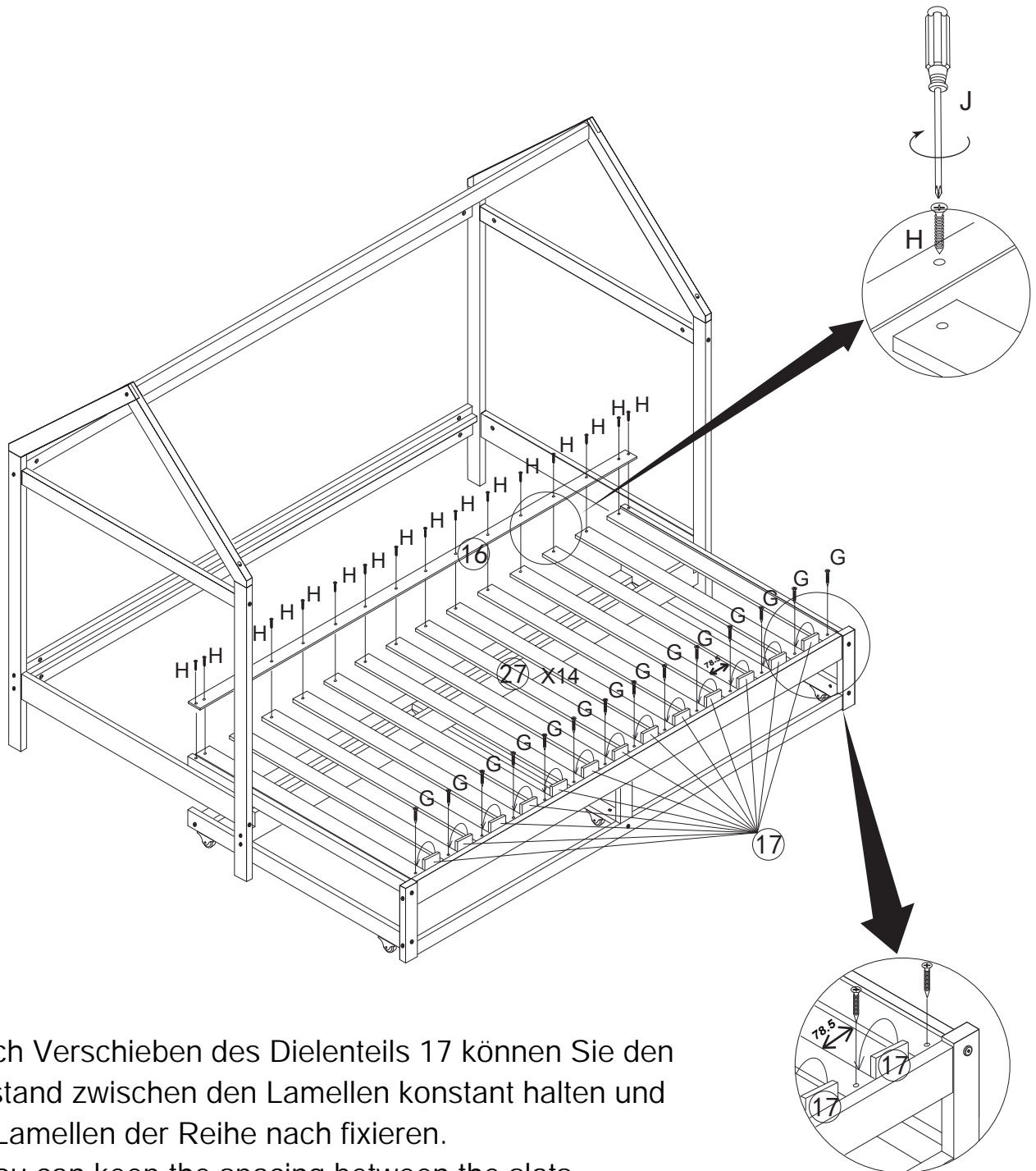

Durch Verschieben des Dielenteils 17 können Sie den Abstand zwischen den Lamellen konstant halten und die Lamellen der Reihe nach fixieren.

( You can keep the spacing between the slats consistent by moving the plank part 17, and fix the slats in sequence. )



Anmerkung:

Wir empfehlen Ihnen, Ihr Bett im flachen Boden zusammenzubauen

Note:

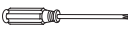

We recommend you to assemble your bed in flat floor

## SCHRITT 10:

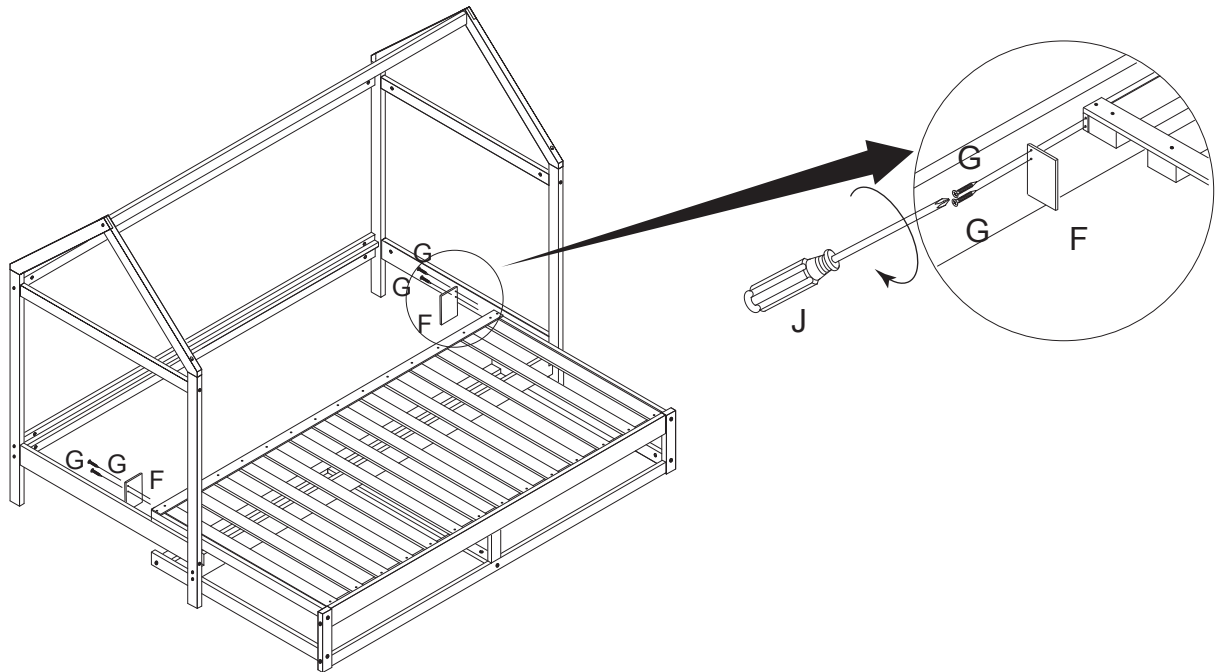
F	G	J
	 Φ4*30mm	
2pcs	4pcs	1pc



## SCHRITT 11:

G	J
 Φ4*30mm	
26pcs	1pc

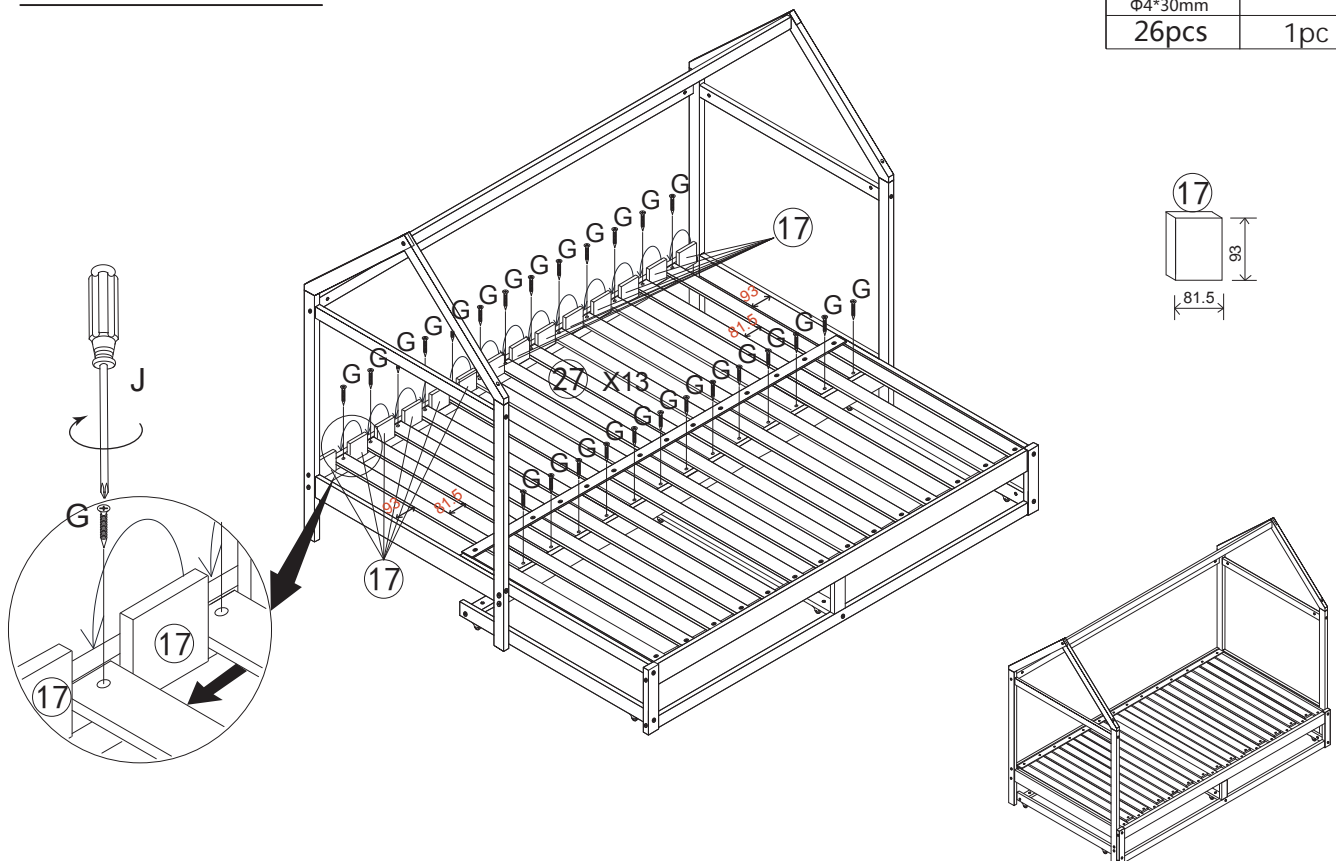



Anmerkung:

Wir empfehlen Ihnen, Ihr Bett im flachen Boden zusammenzubauen

Note:

We recommend you to assemble your bed in flat floor

## SCHRITT 12:

J	L	M
		
1pc	10pcs	10pcs

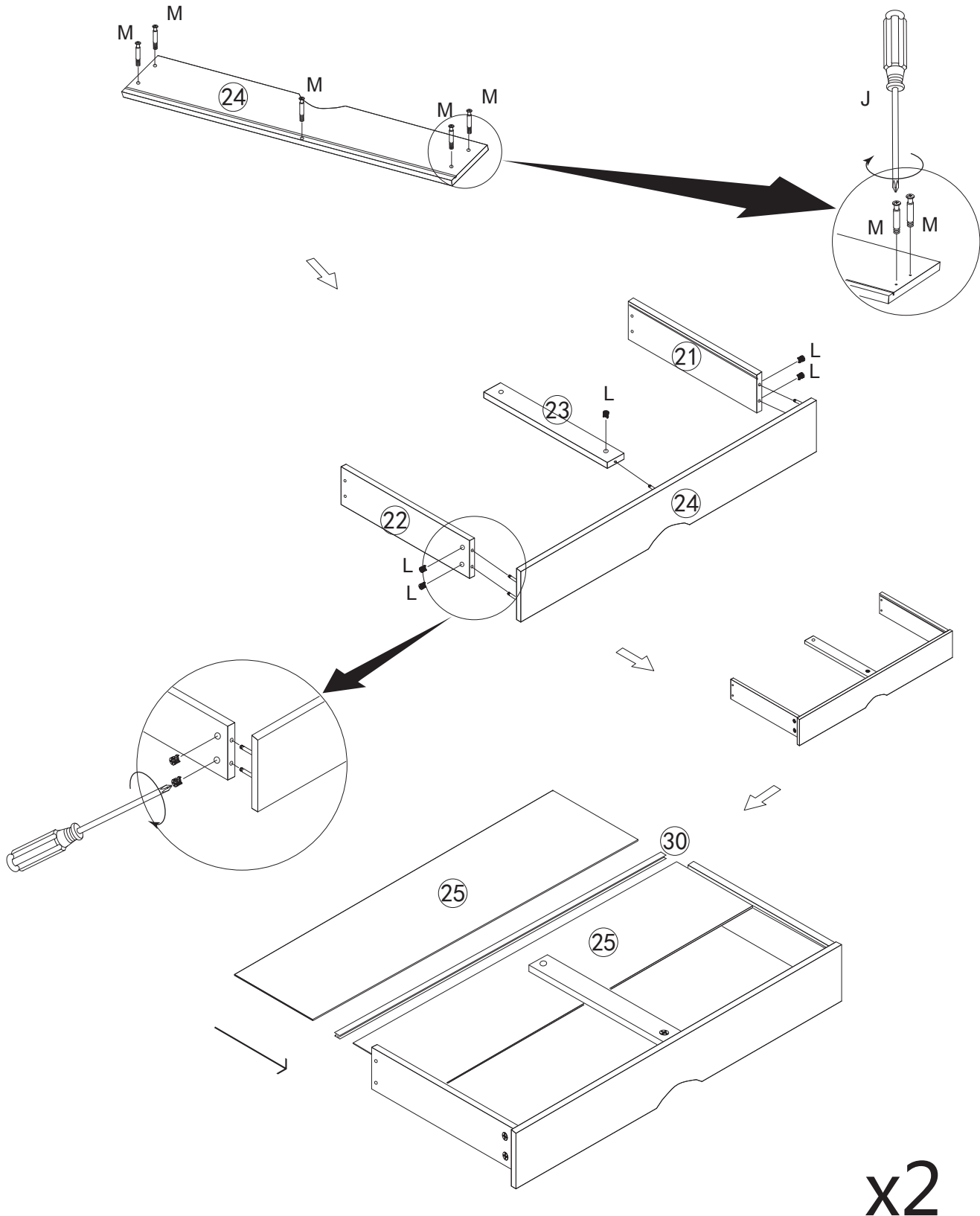



**Anmerkung:**

**Wir empfehlen Ihnen, Ihr Bett im flachen Boden zusammenzubauen**

Note:

We recommend you to assemble your bed in flat floor

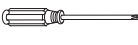
**SCHRITT 13:**

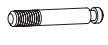
G	J	L	M
 Φ4*30mm			
8pcs	1pc	2pcs	2pcs

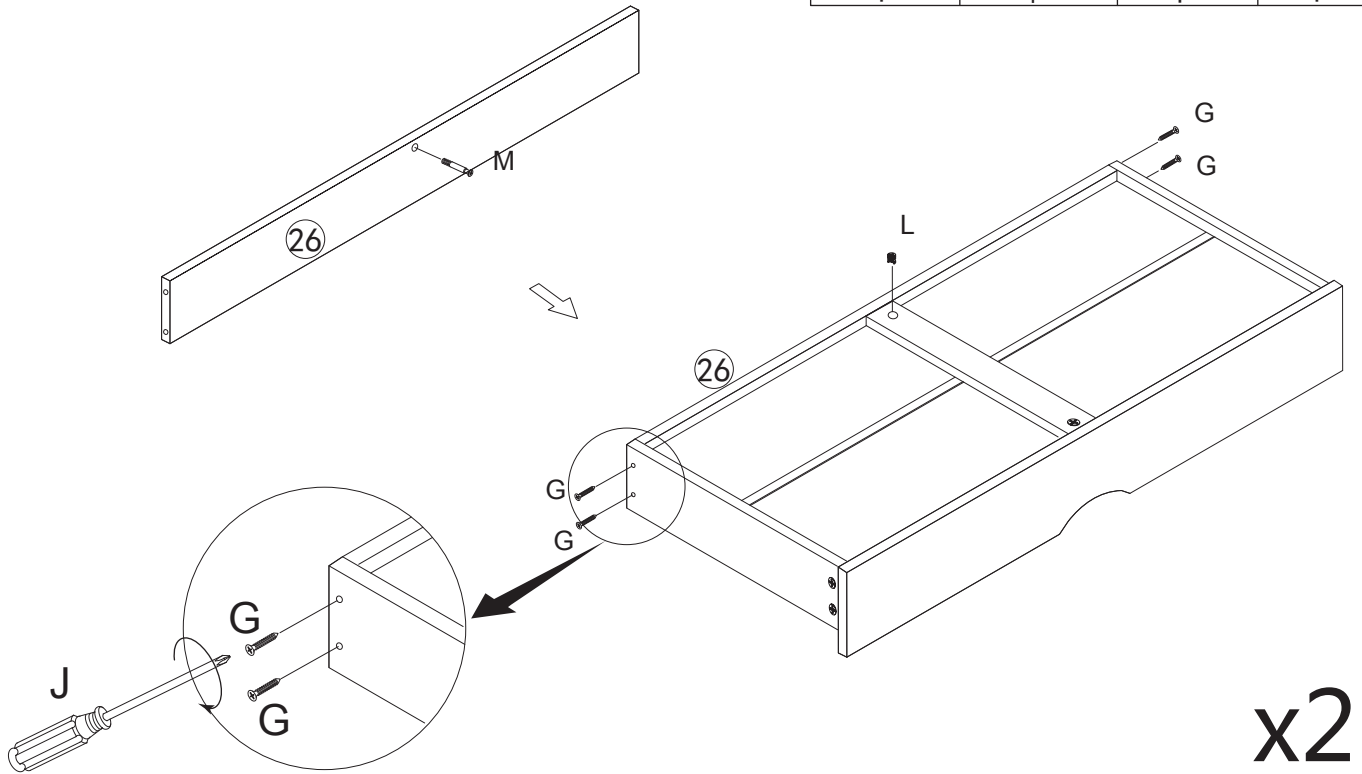

**SCHRITT 14:**

