

58.602

Viewlite Dual-Monitorarm-Upgrade-Kit - Option 602

In nur wenigen Schritten bauen Sie Ihren "Viewlite plus Monitorarm - Schreibtisch 62" auf einen "Viewlite plus Monitorarm - Schreibtisch 65" aus, an dem sich zwei Monitore oder Geräte befestigen lassen, die Sie unabhängig in der Tiefe und dynamisch in der Höhe verstellen können.

- Set enthält einen Viewlite Doppel-Aufnahmedorn-Adapter und einen Viewlite plus Monitorarm (Tischbefestigungen nicht mitgeliefert)
- Monitor: neigbar +90°/-55°, schwenkbar +90°/-90°, Drehbar 360°
- Arm: schwenkbar +65°/-65°
- Schwenkblockade voreingestellt auf +65°/-65° (kann auf nur +65° umgestellt werden)

viewlite X

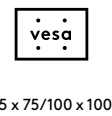
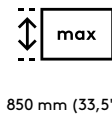
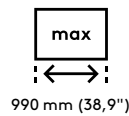
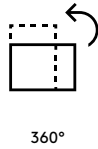
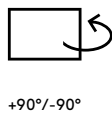
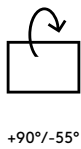
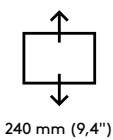
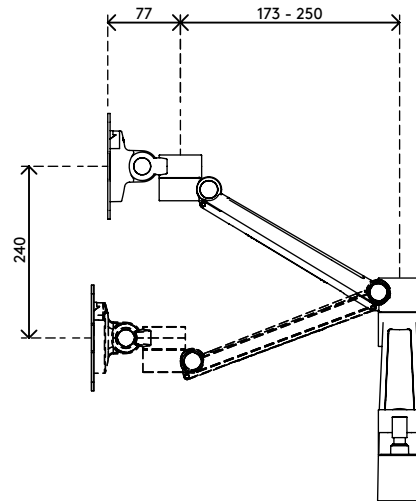
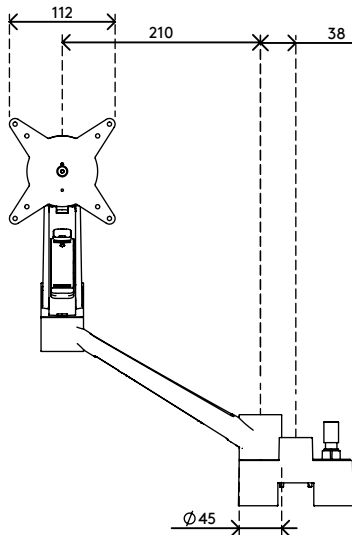
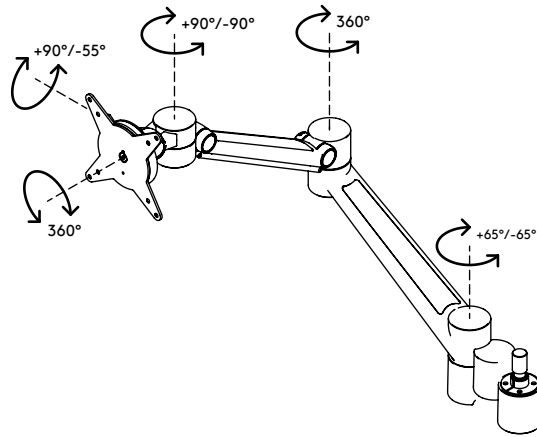
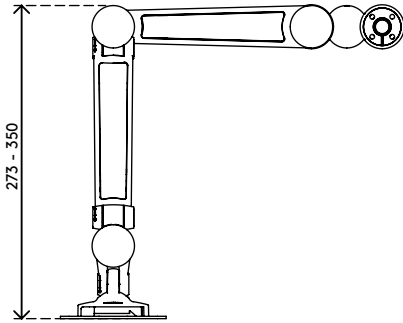

Viewlite Dual-Monitorarm-Upgrade-Kit - Option 602

2016/11/23

58.602

375 x 265 x 105 mm

1 pcs

silber-Weiß

2,75 kg

805410586027