

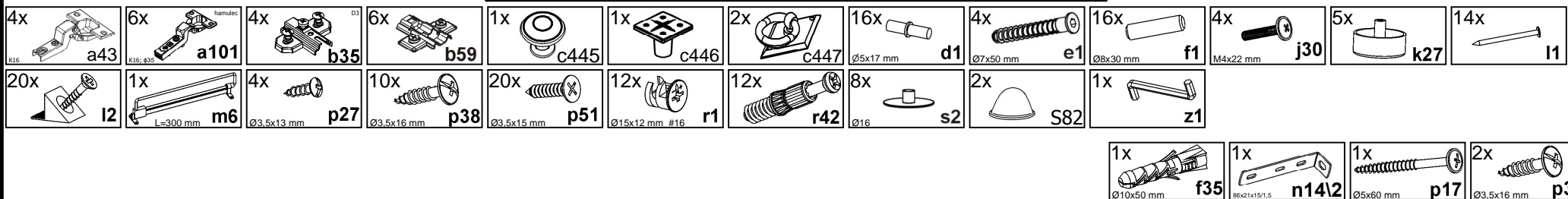

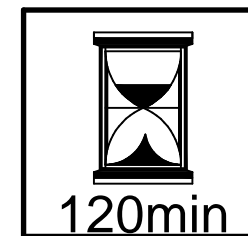

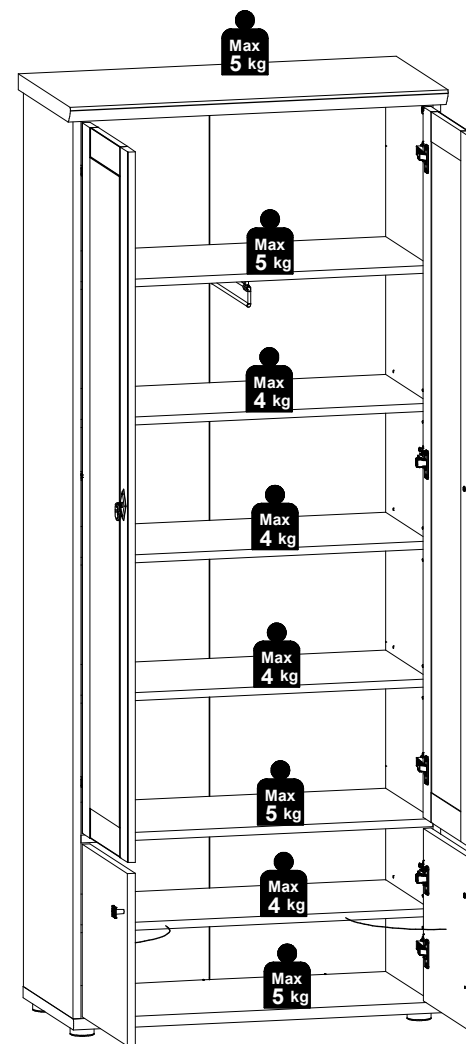

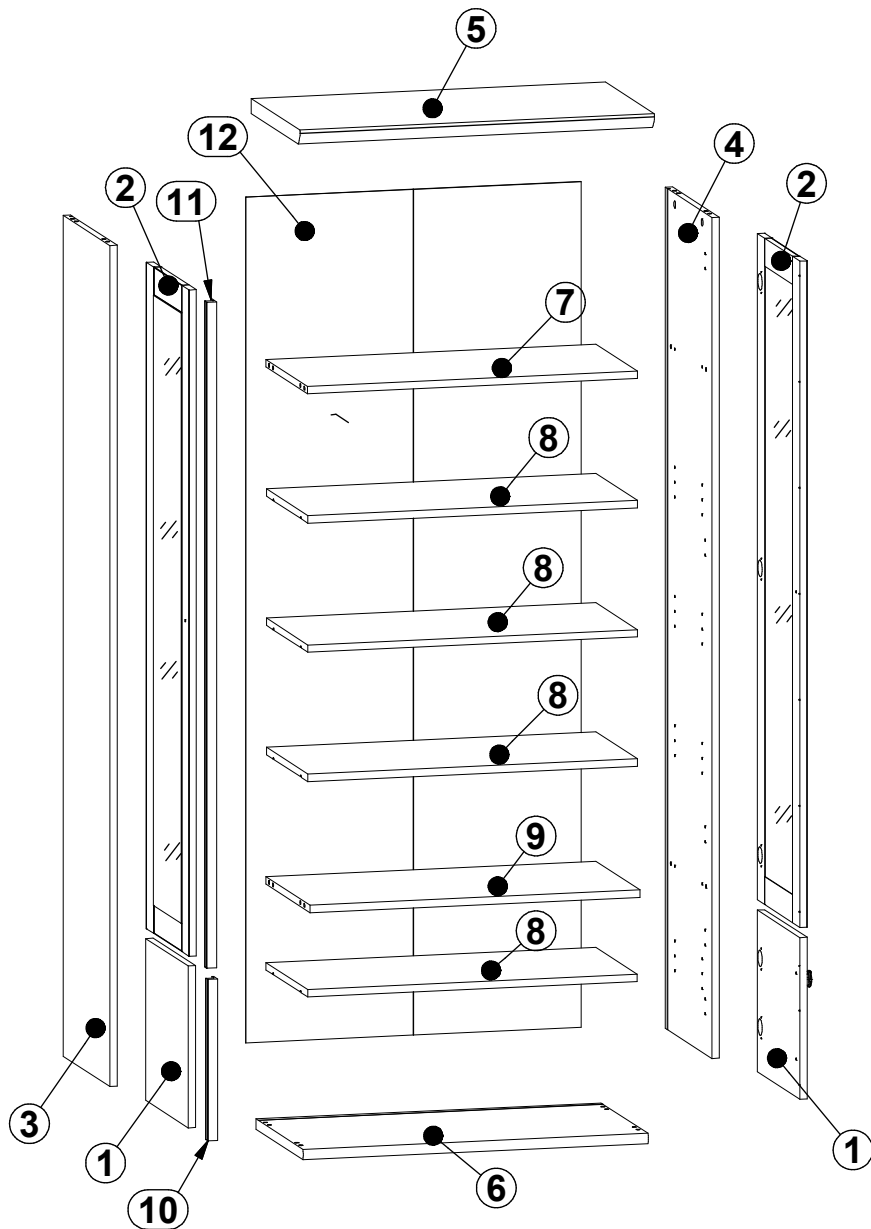





A	B	C (mm)		D
1	M196-0001	348	348	2/2
2	M196-0002	1433	348	2/2
3	M196-1001	1809	382	2/2
4	M196-1002	1809	382	2/2
5	M196-2001	777	400	1/2
6	M196-2002	757	387	1/2
7	M196-3001	724	340	1/2
8	M196-3002	723	340	1/2
9	M196-3003	724	362	1/2
10	M196-5501	347	33	2/2
11	M196-5502	1432	33	2/2
12	M196-9301	1819	735	2/2

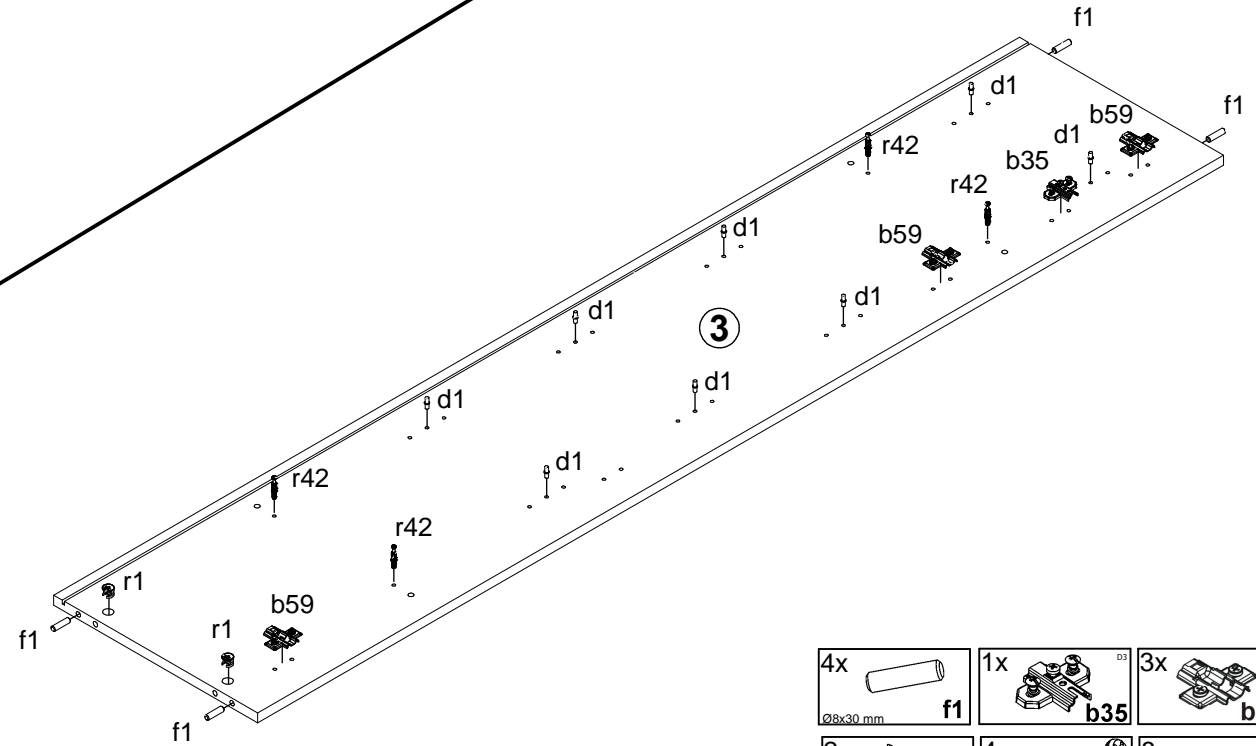
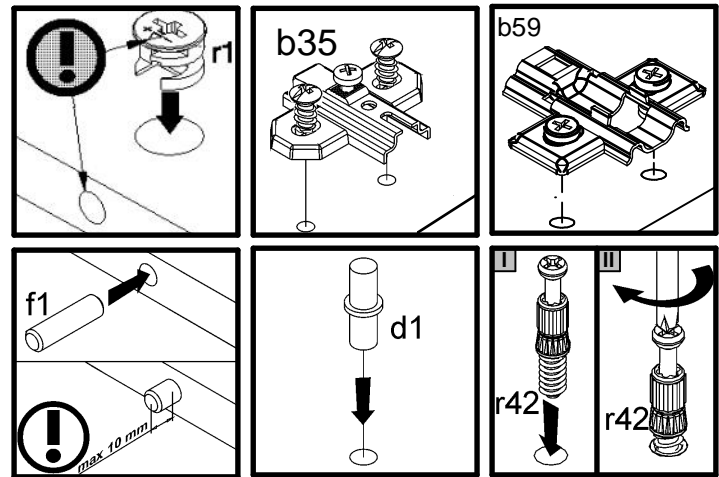
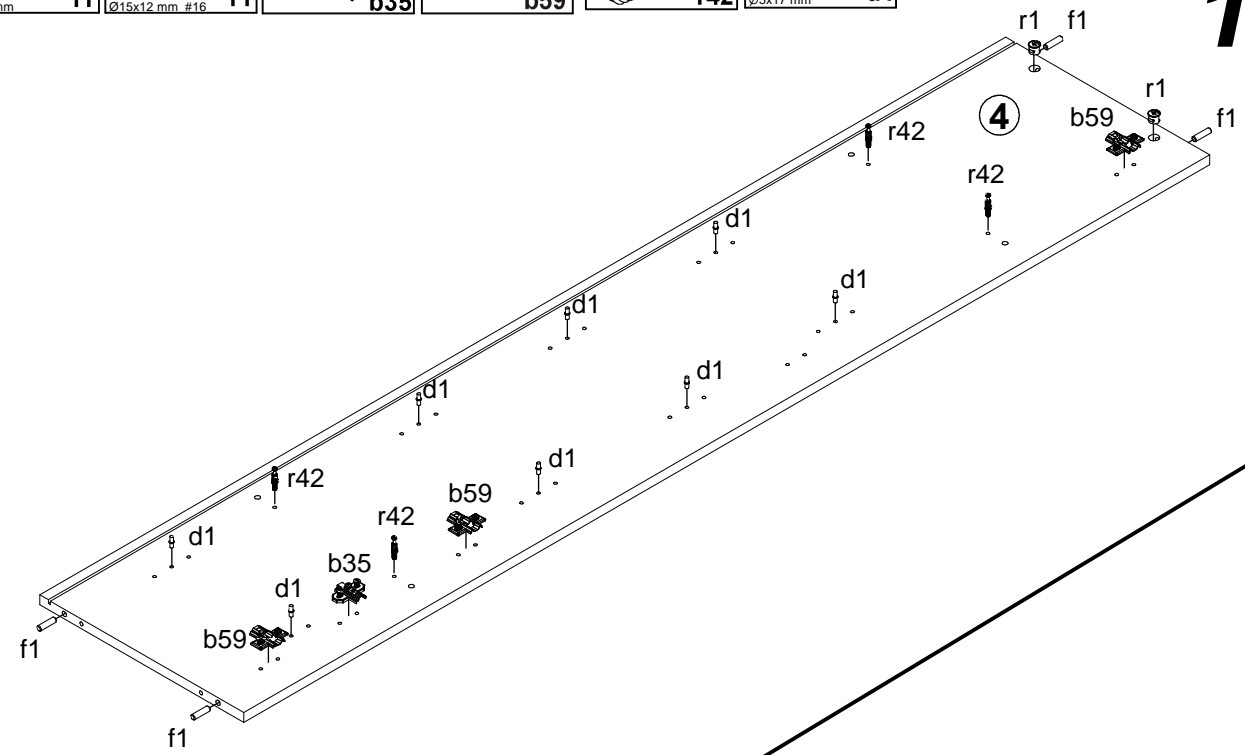
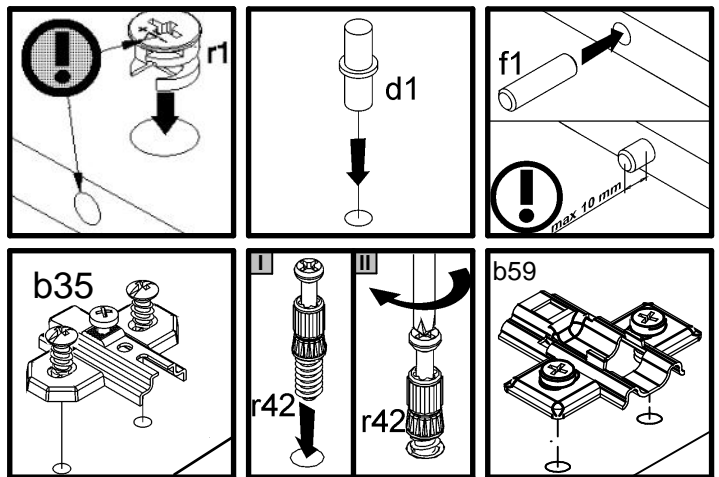



- 4x  f1
- 2x  r1
- 1x  b35
- 3x  b59
- 4x  r42
- 8x  d1

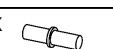

- 4x  f1
- 1x  b35
- 3x  b59
- 2x  r1
- 4x  r42
- 8x  d1

A

M196-REG2D2L/19/8

3064--01

5 / 12

1

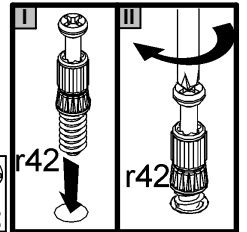
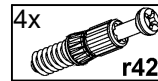
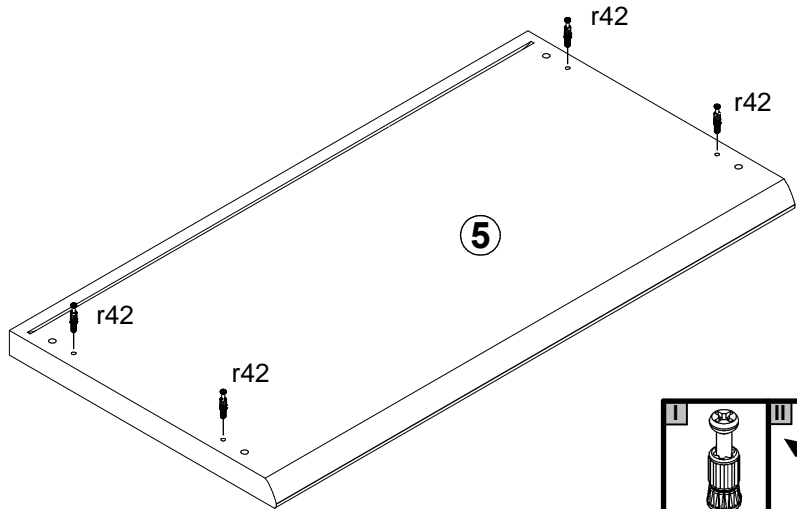
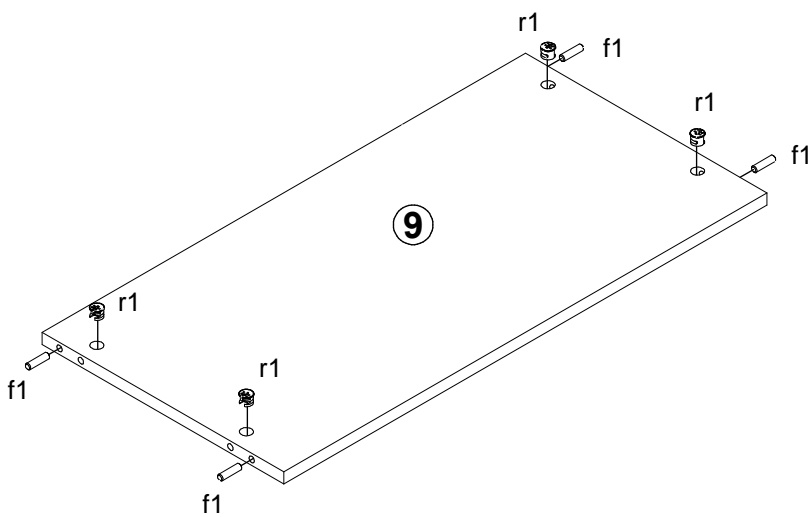
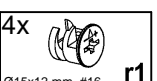
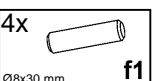
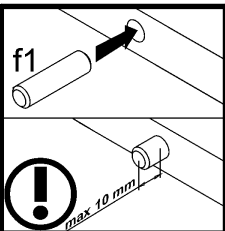
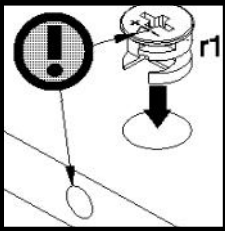
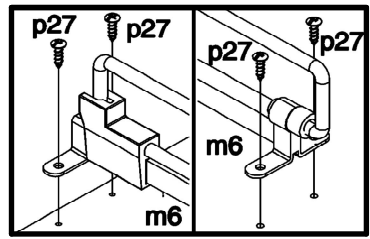
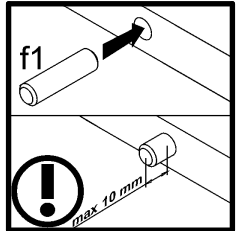
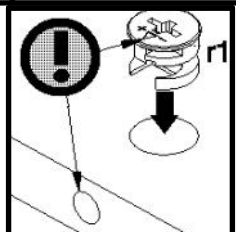
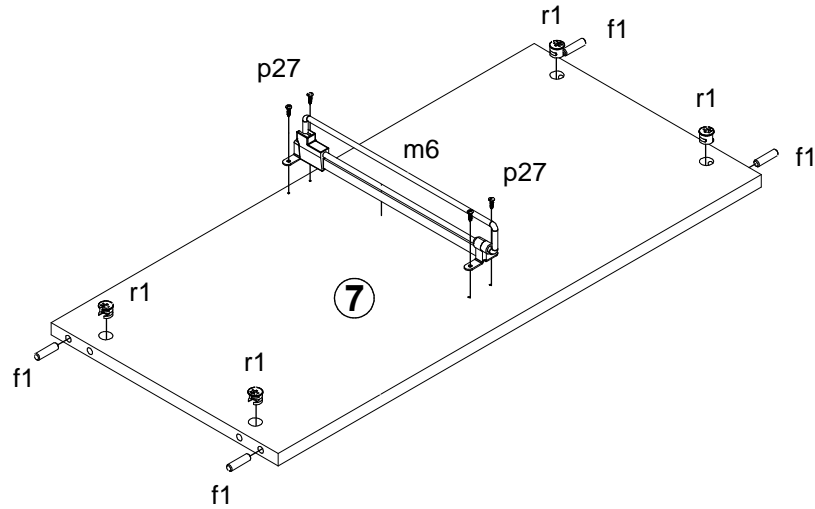
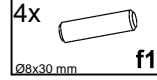
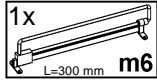
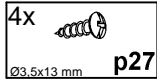

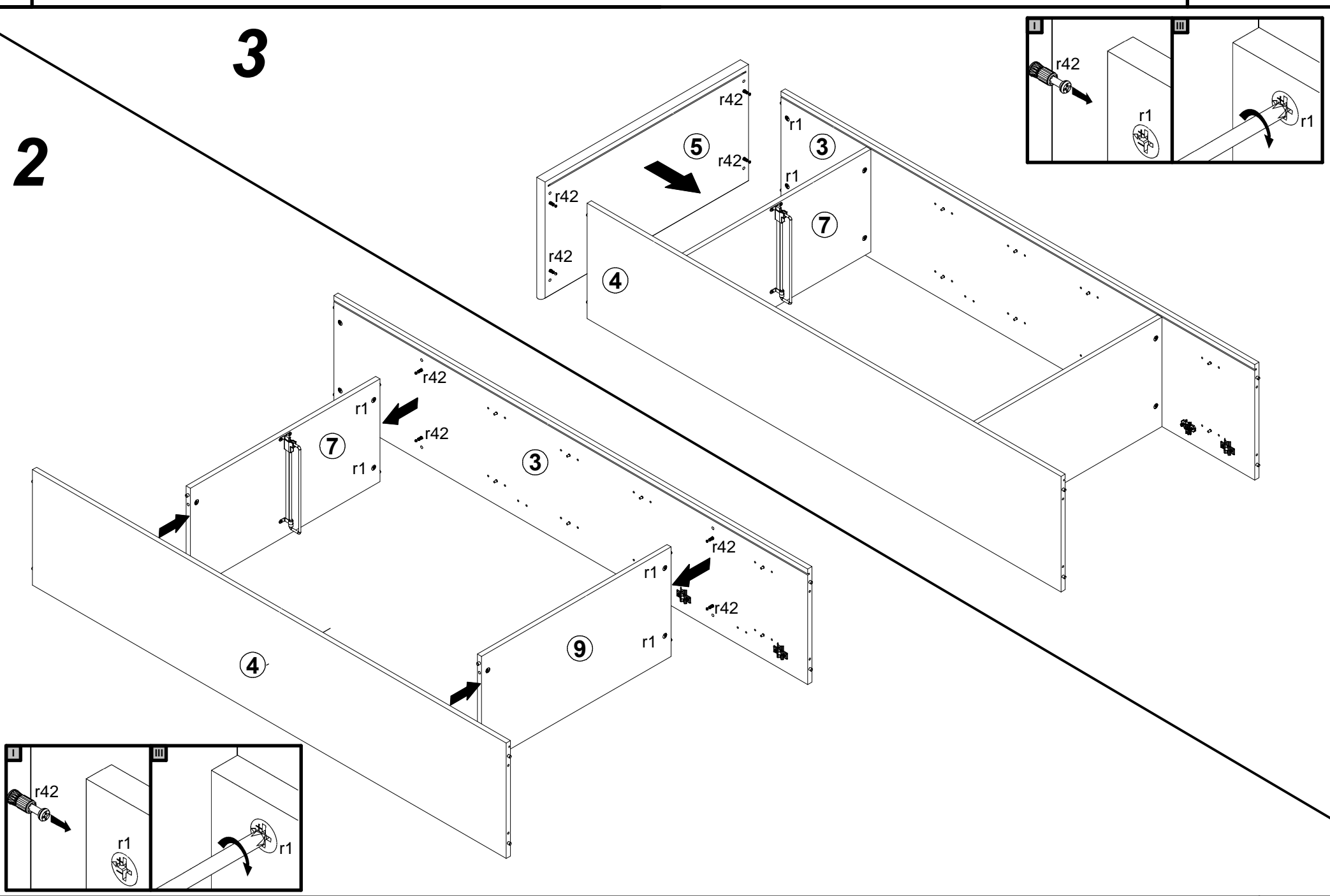

5

4

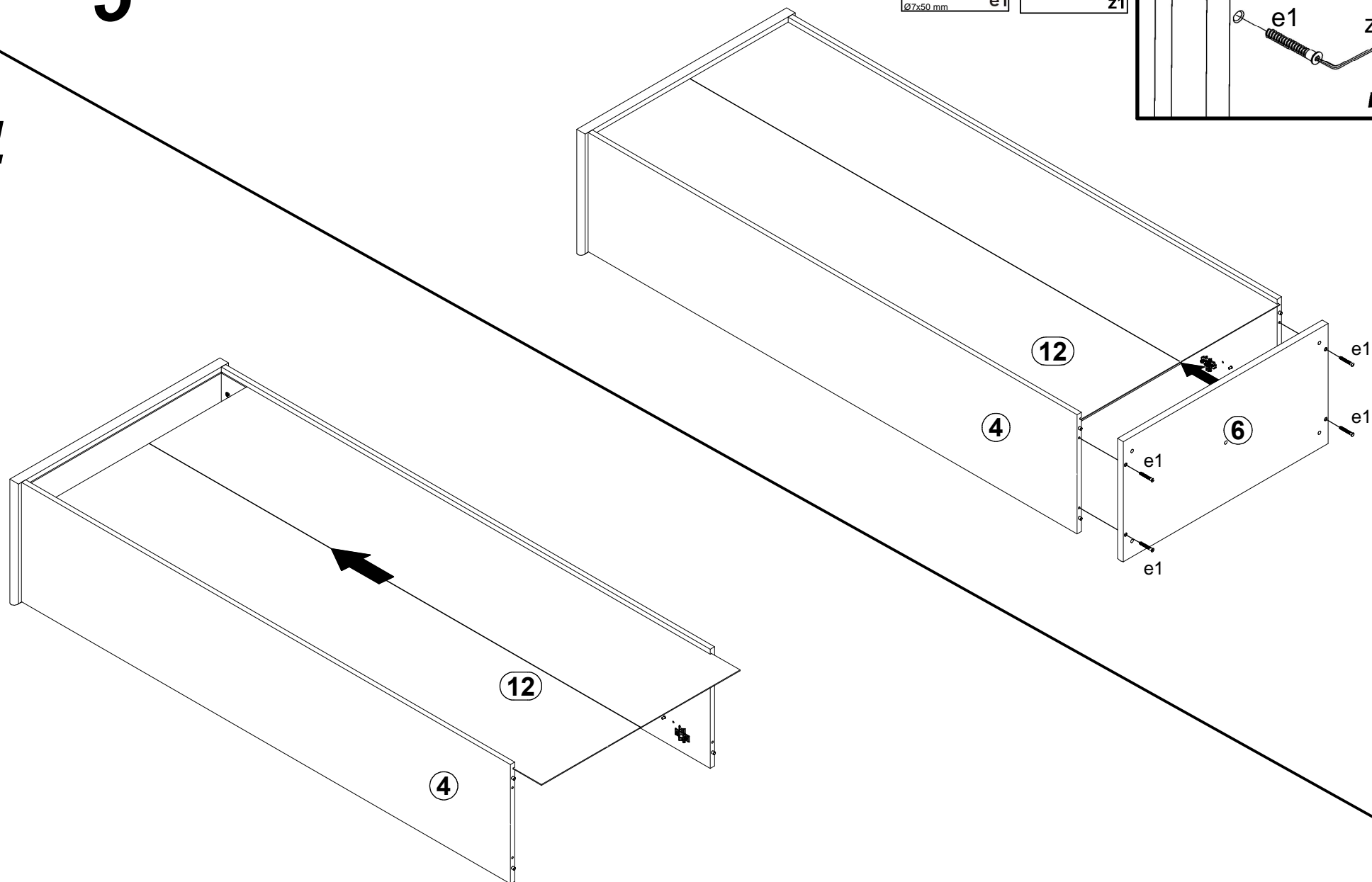
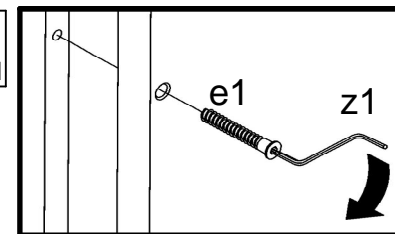
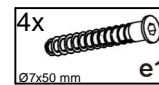

A

M196-REG2D2L/19/8

3064--01

8 / 12

6

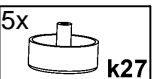
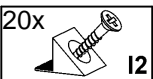
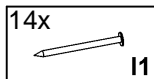
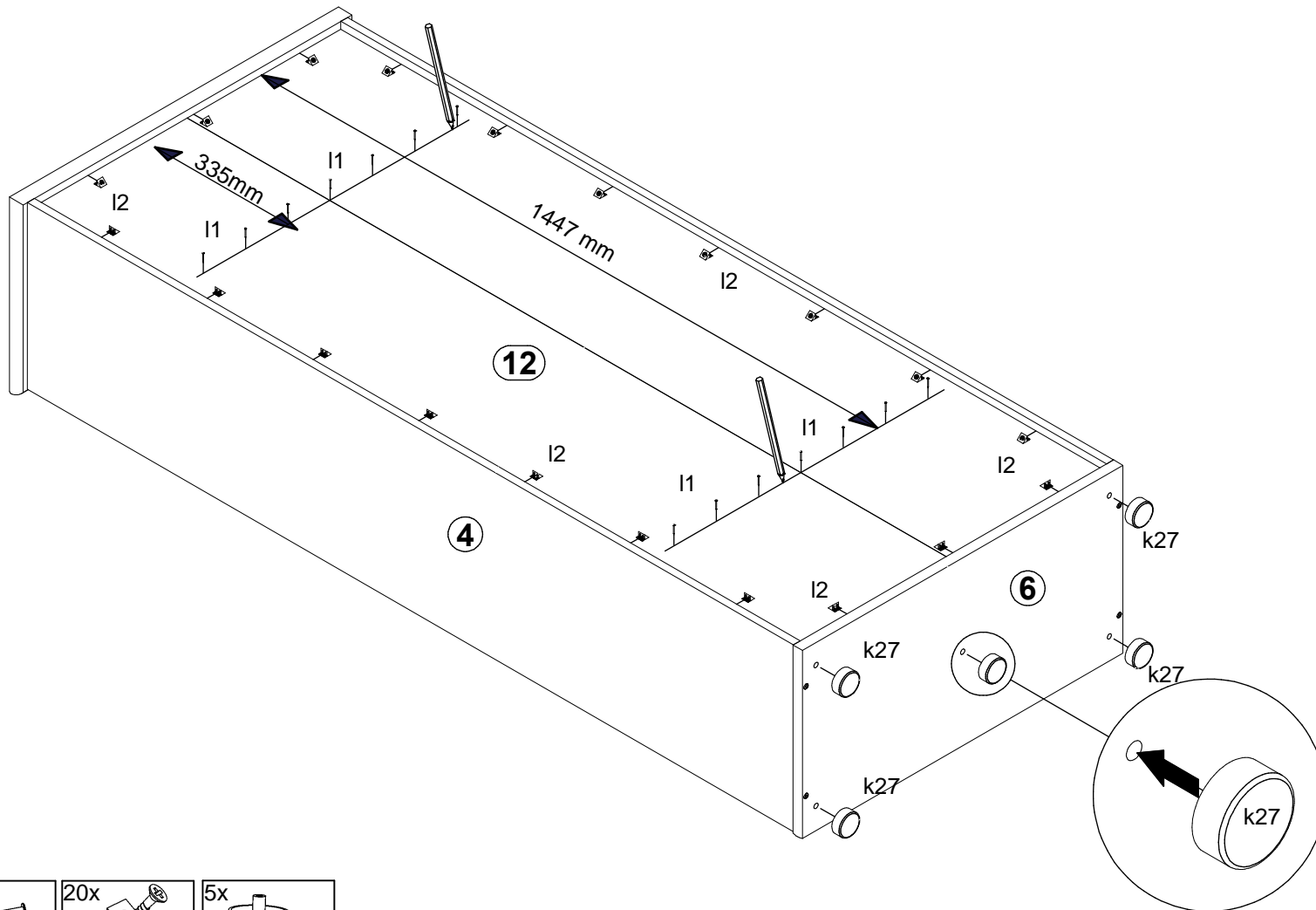
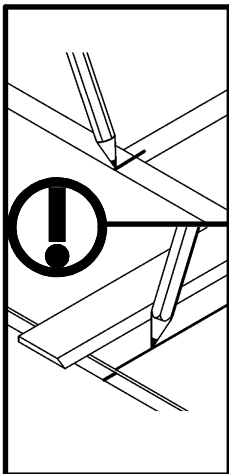
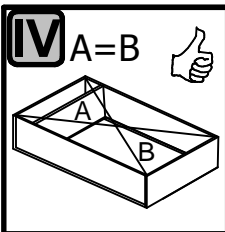
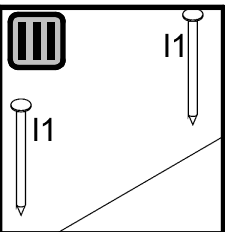
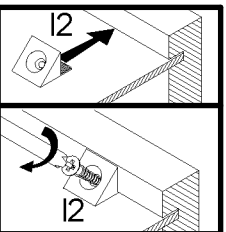
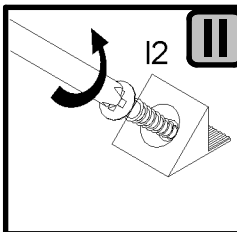
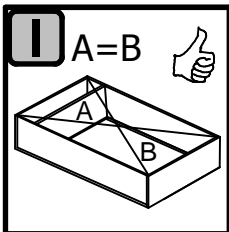



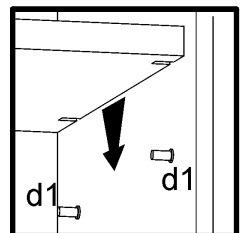
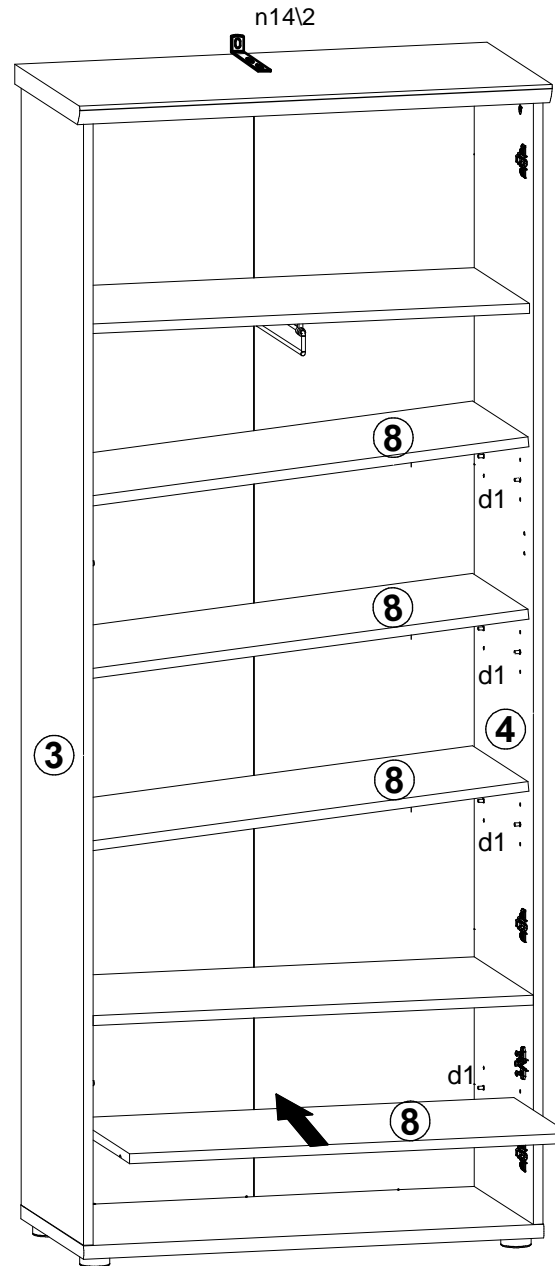
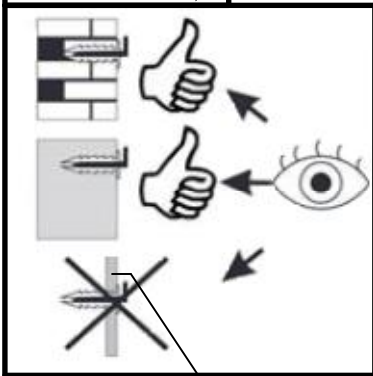
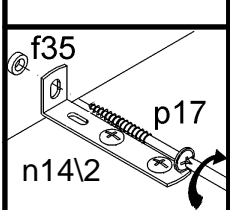
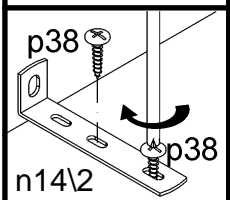
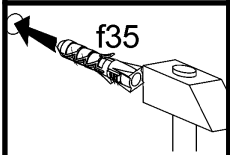
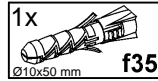
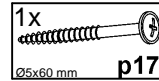
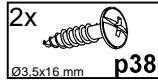
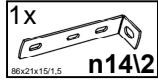
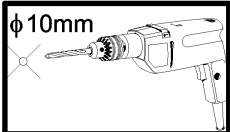

# 8

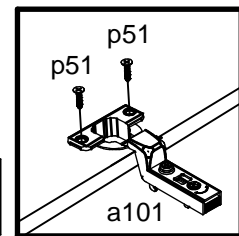
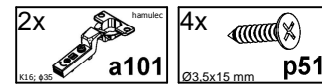
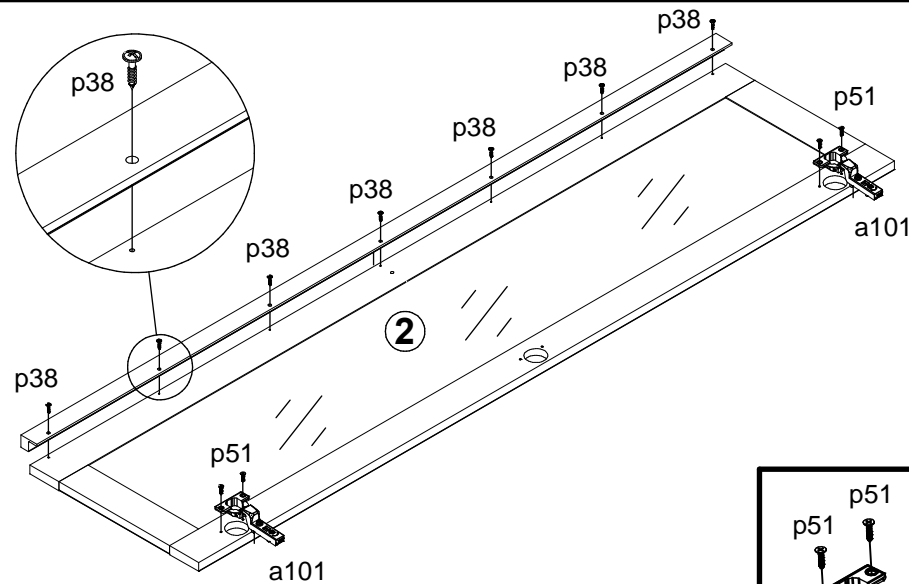
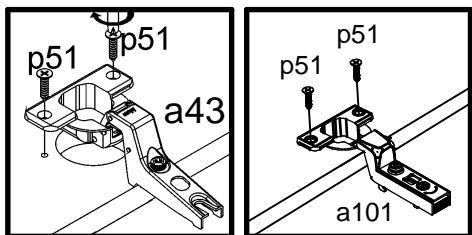
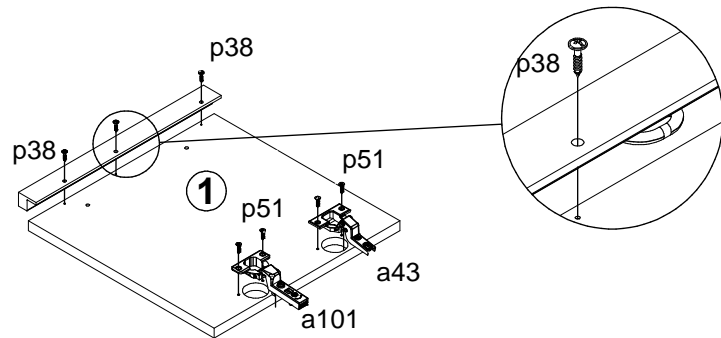
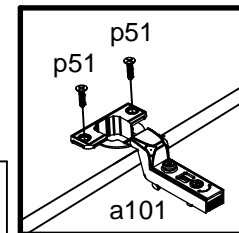
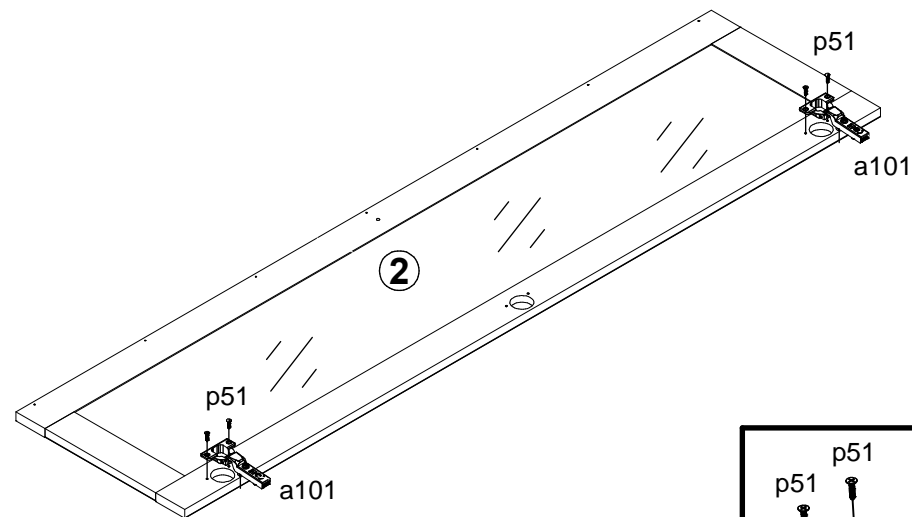
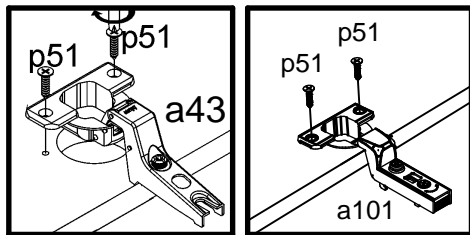
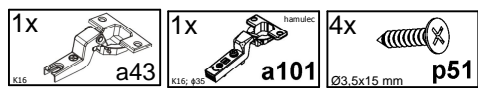
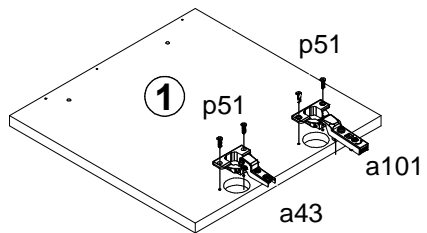

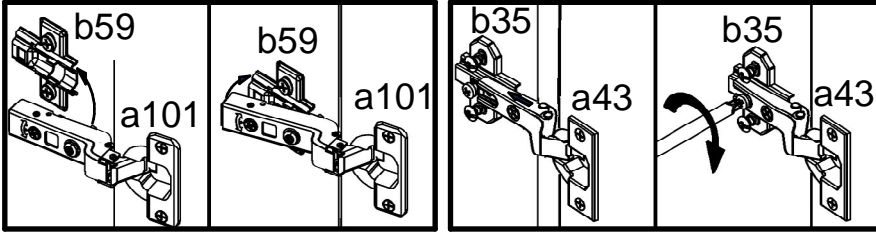

9

10

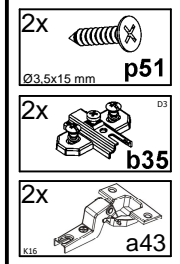
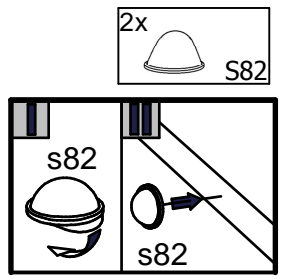
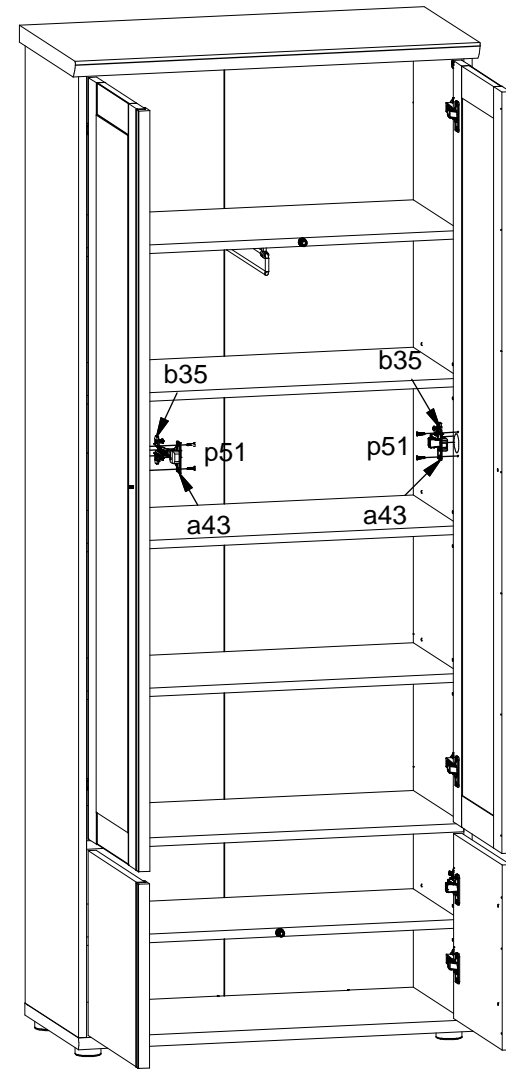
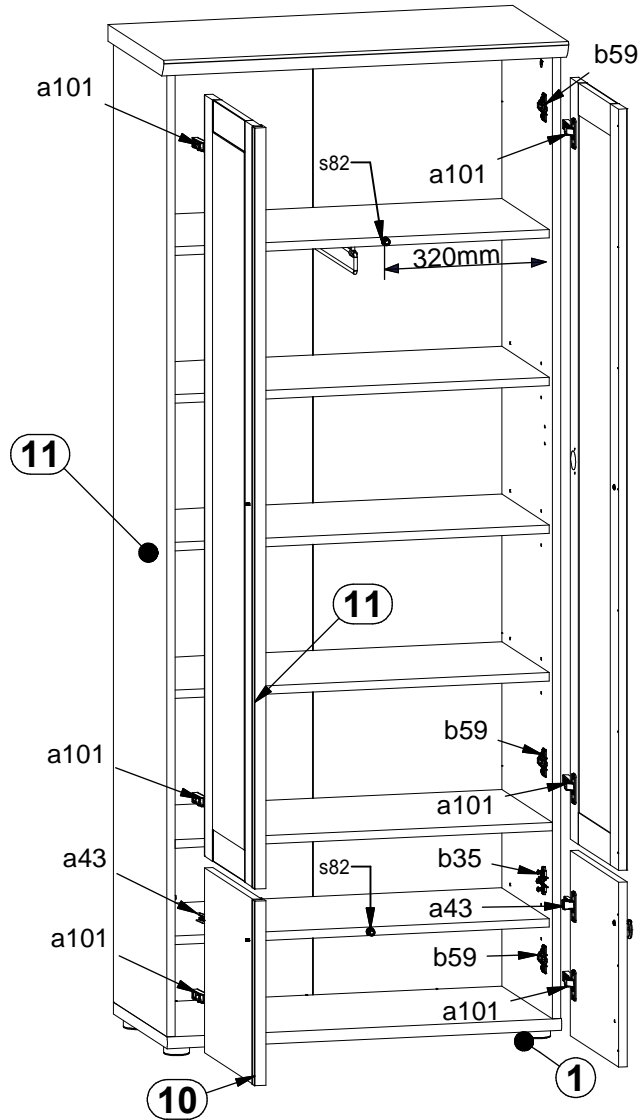
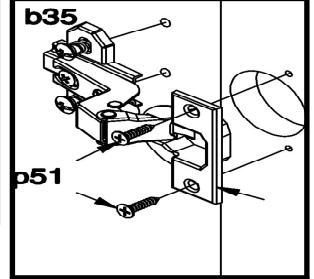
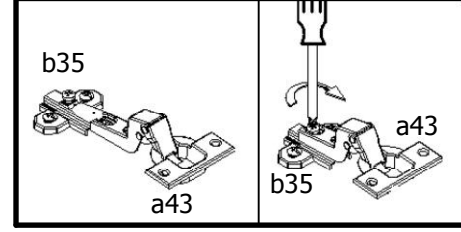

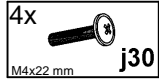
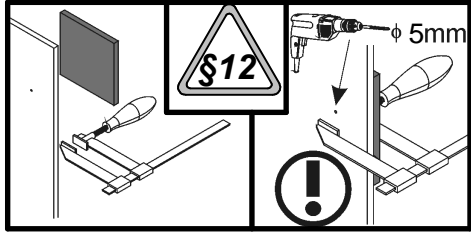

11

