

# Assembly Instruction(1/2)

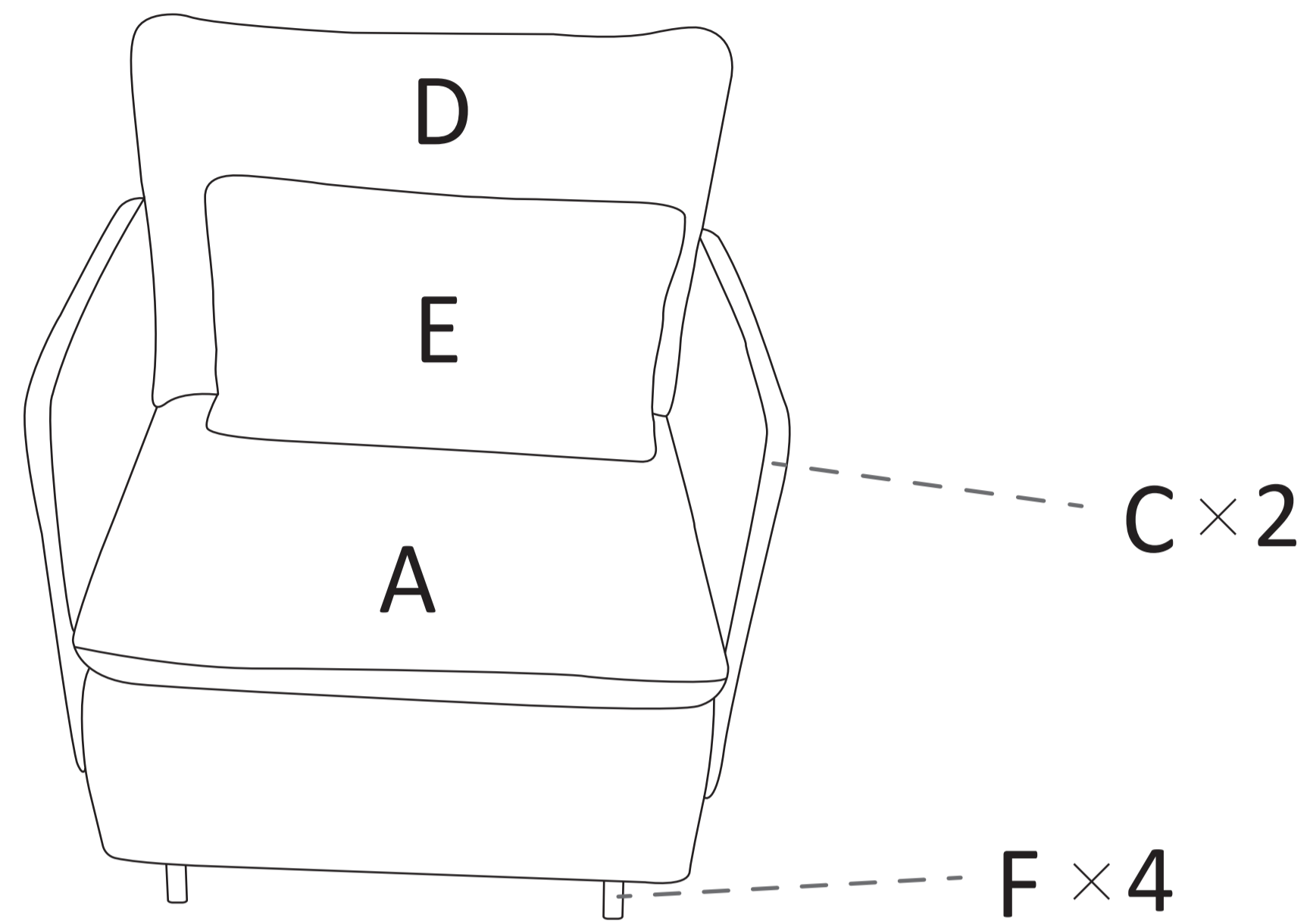

## Step 2

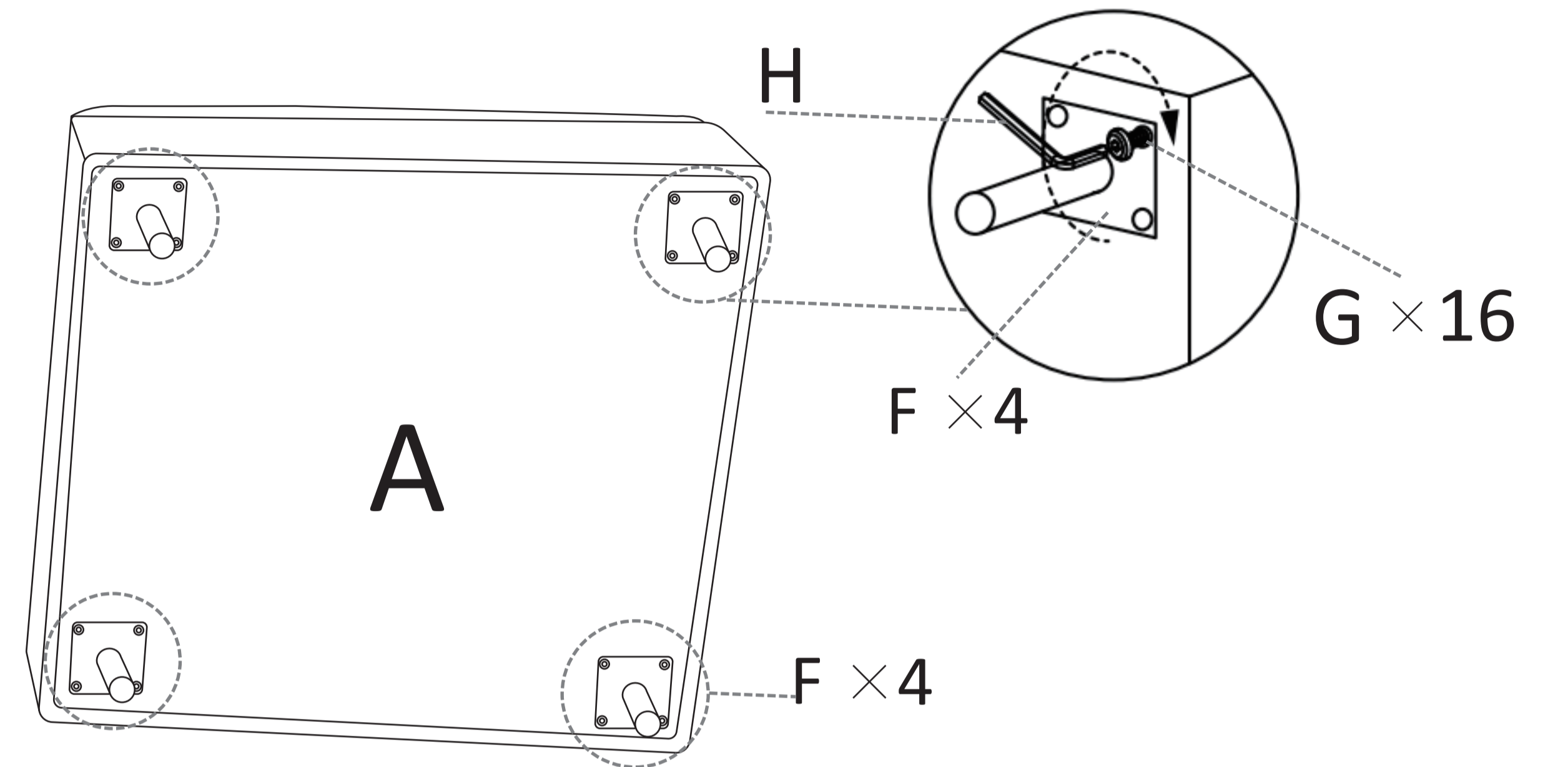

**Step 1** Open the package, remove the parts, and check the quantity.

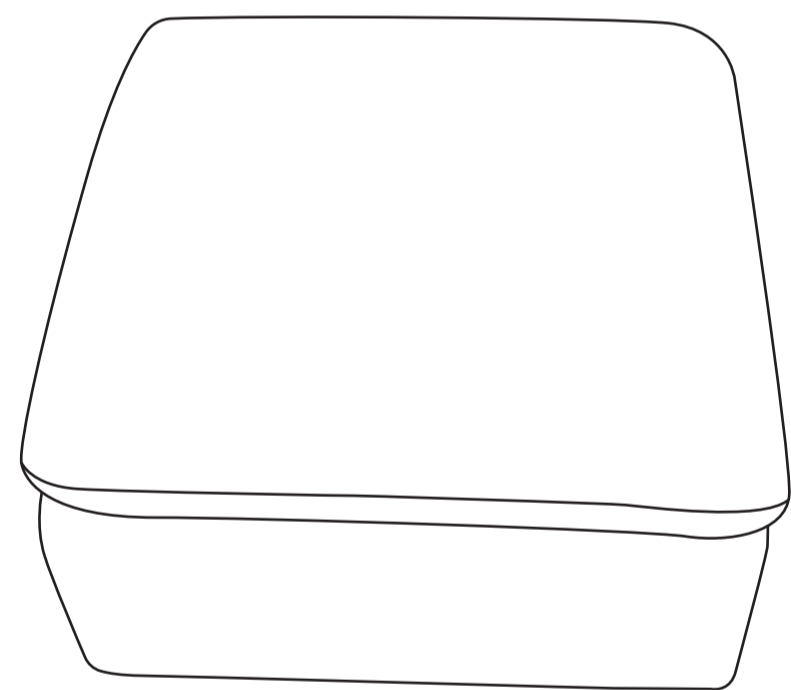

A

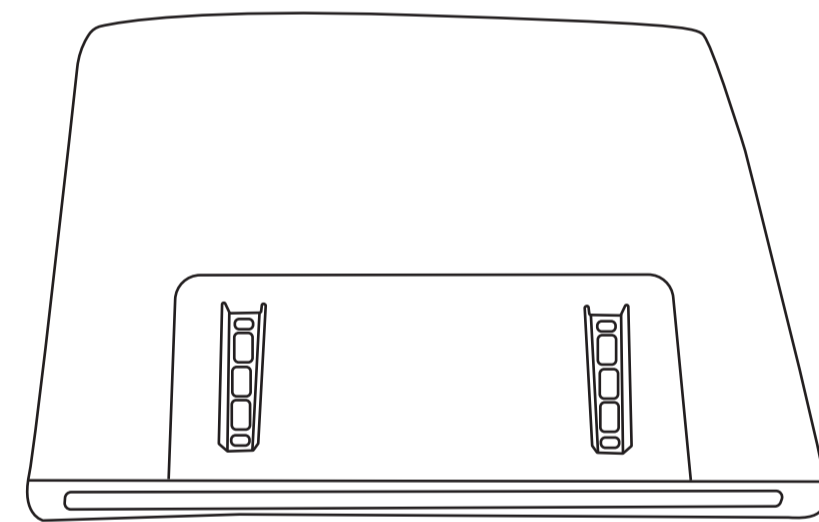

B

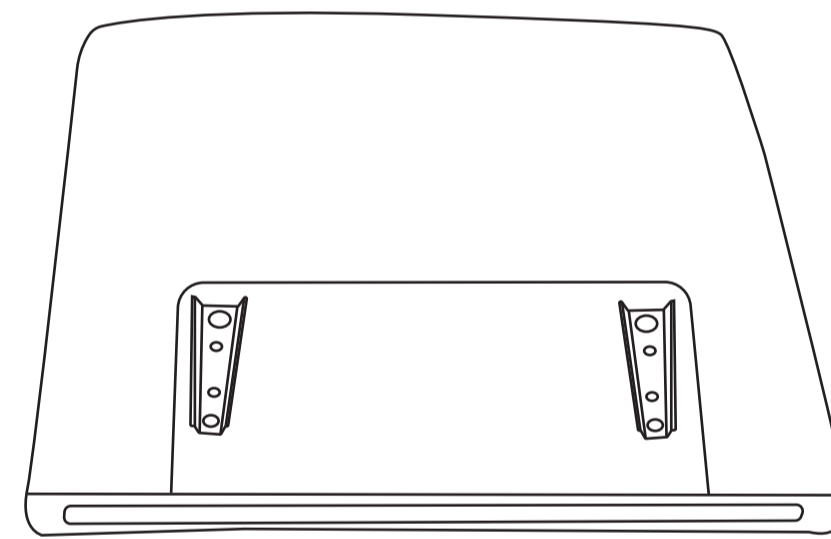

C × 2

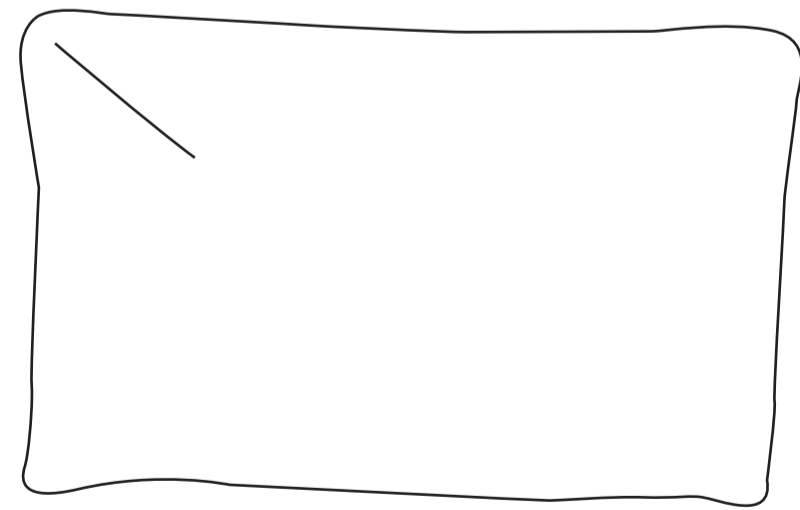

D

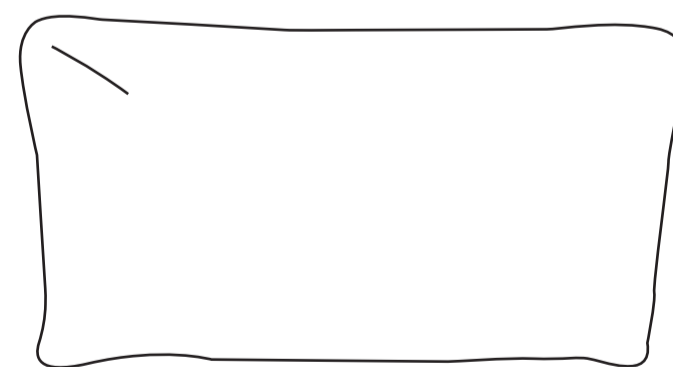

E

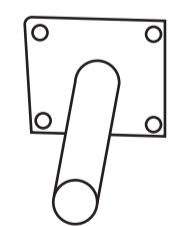

F × 4

## Step 3

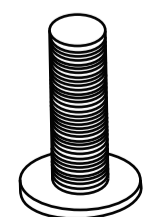
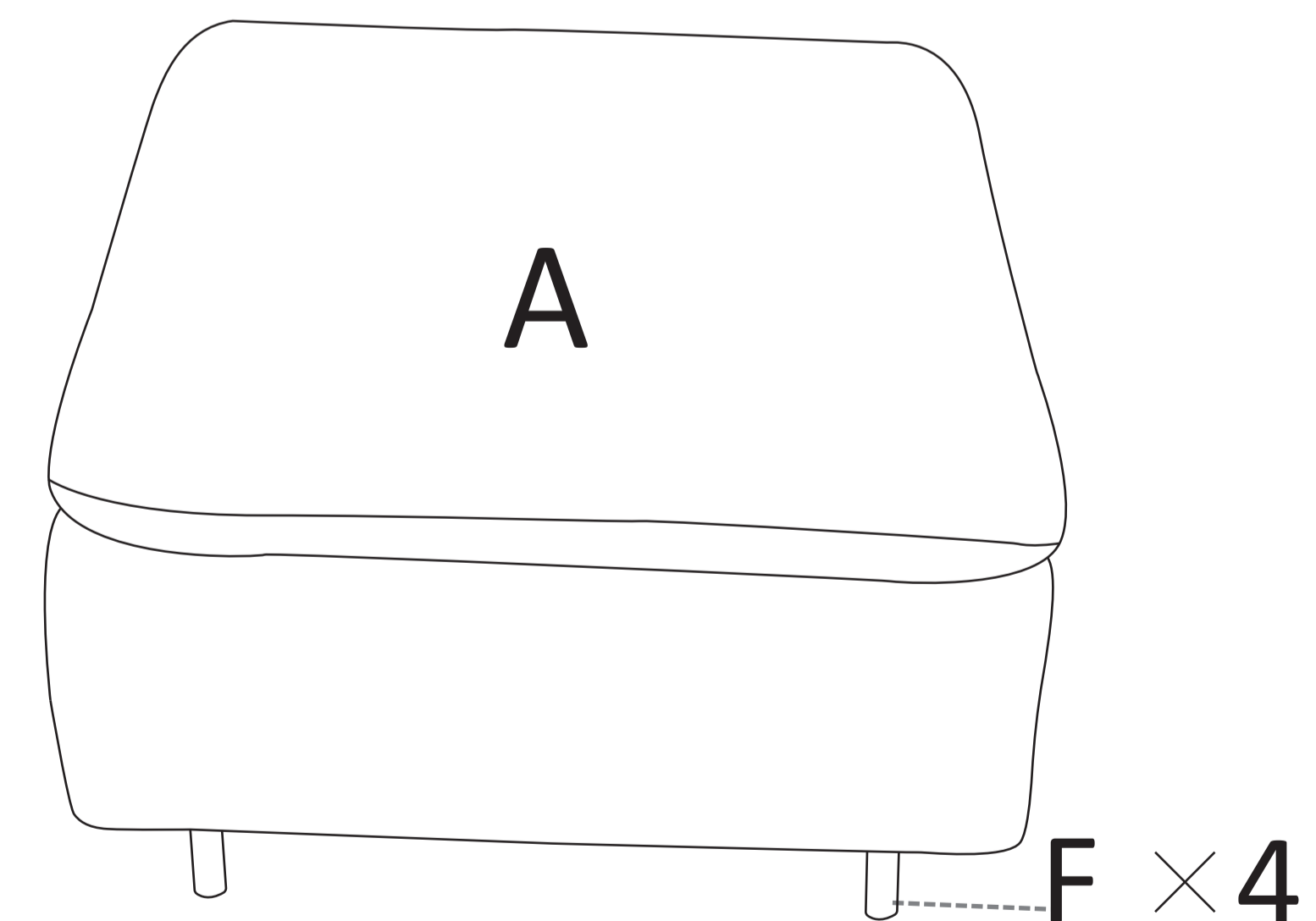

G × 16

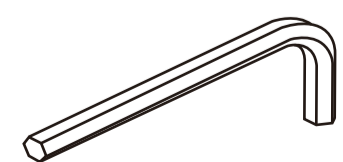

H × 1

# Assembly Instruction(2/2 )

## Step 4

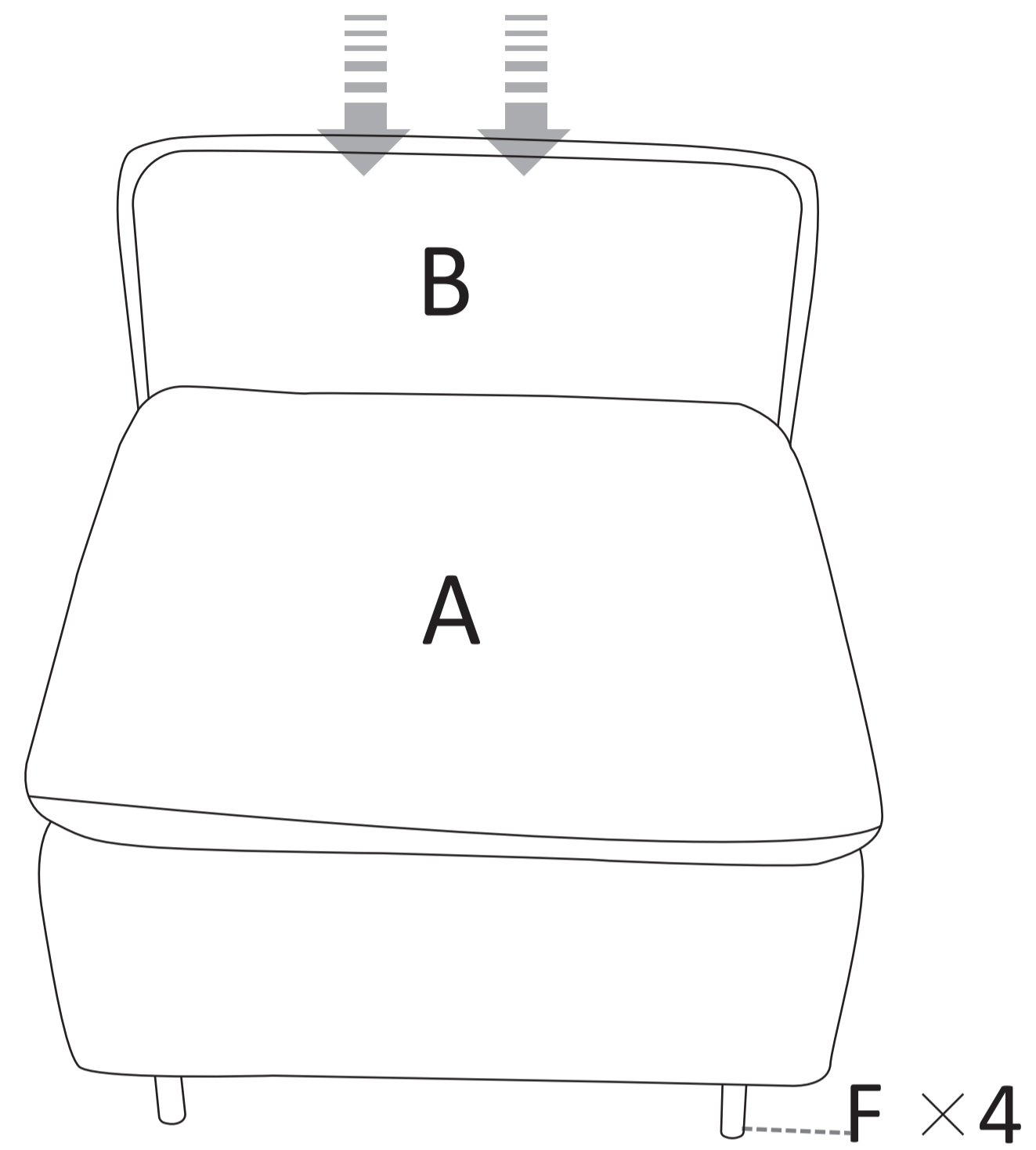

## Step 5

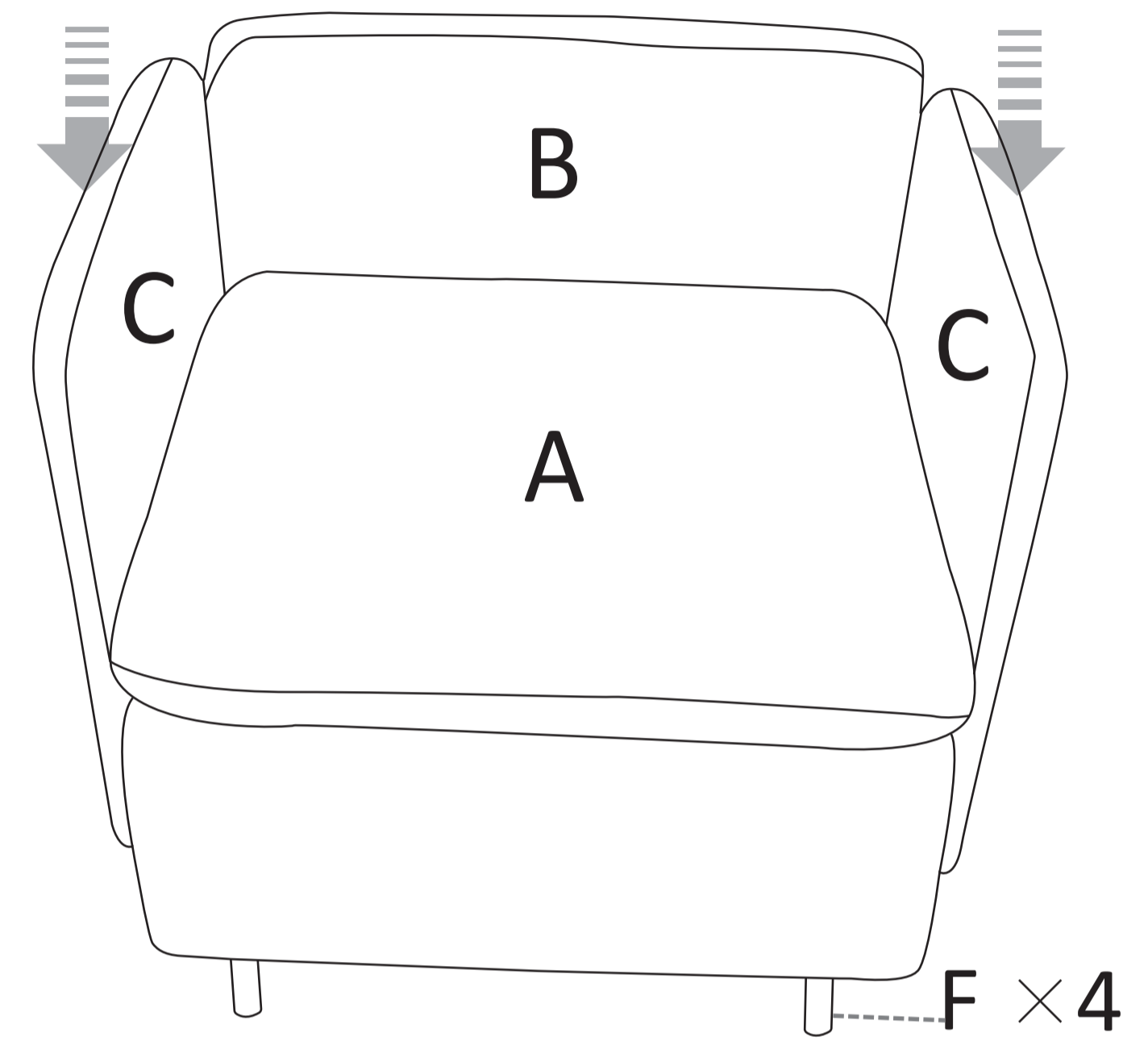

## Step 6

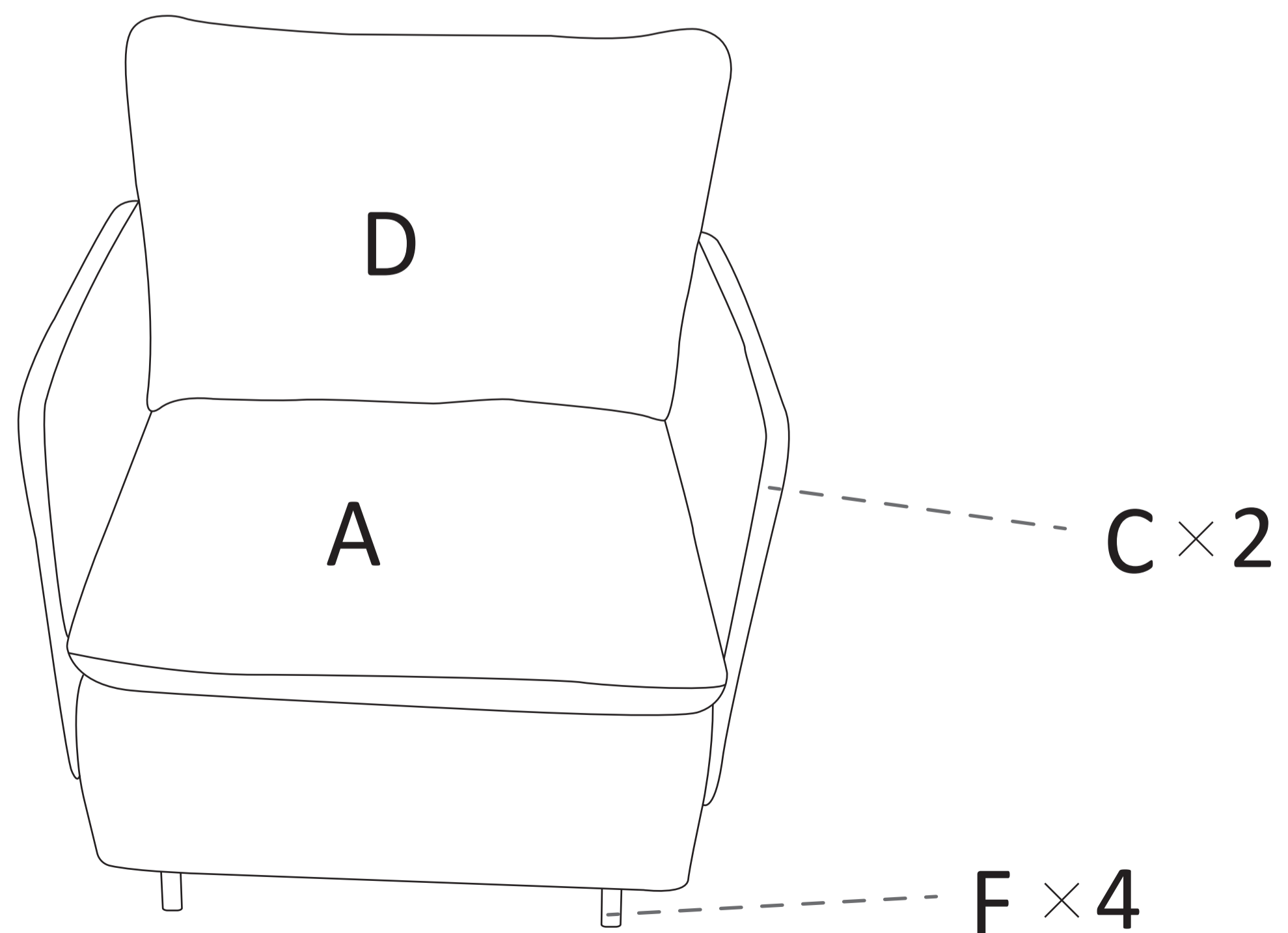

## Step 7

