

MONTAGEANLEITUNGEN

KINDERBETT

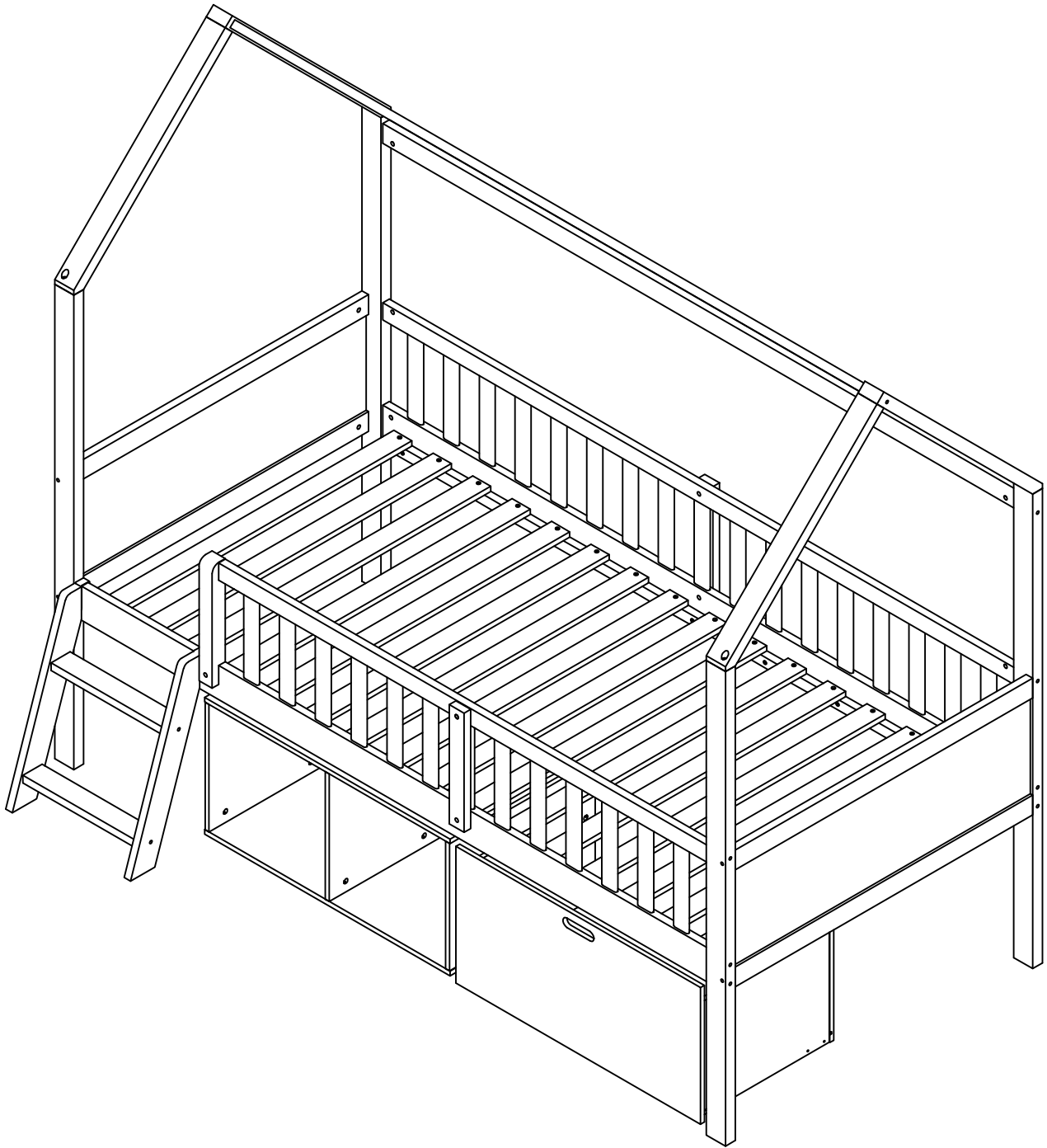





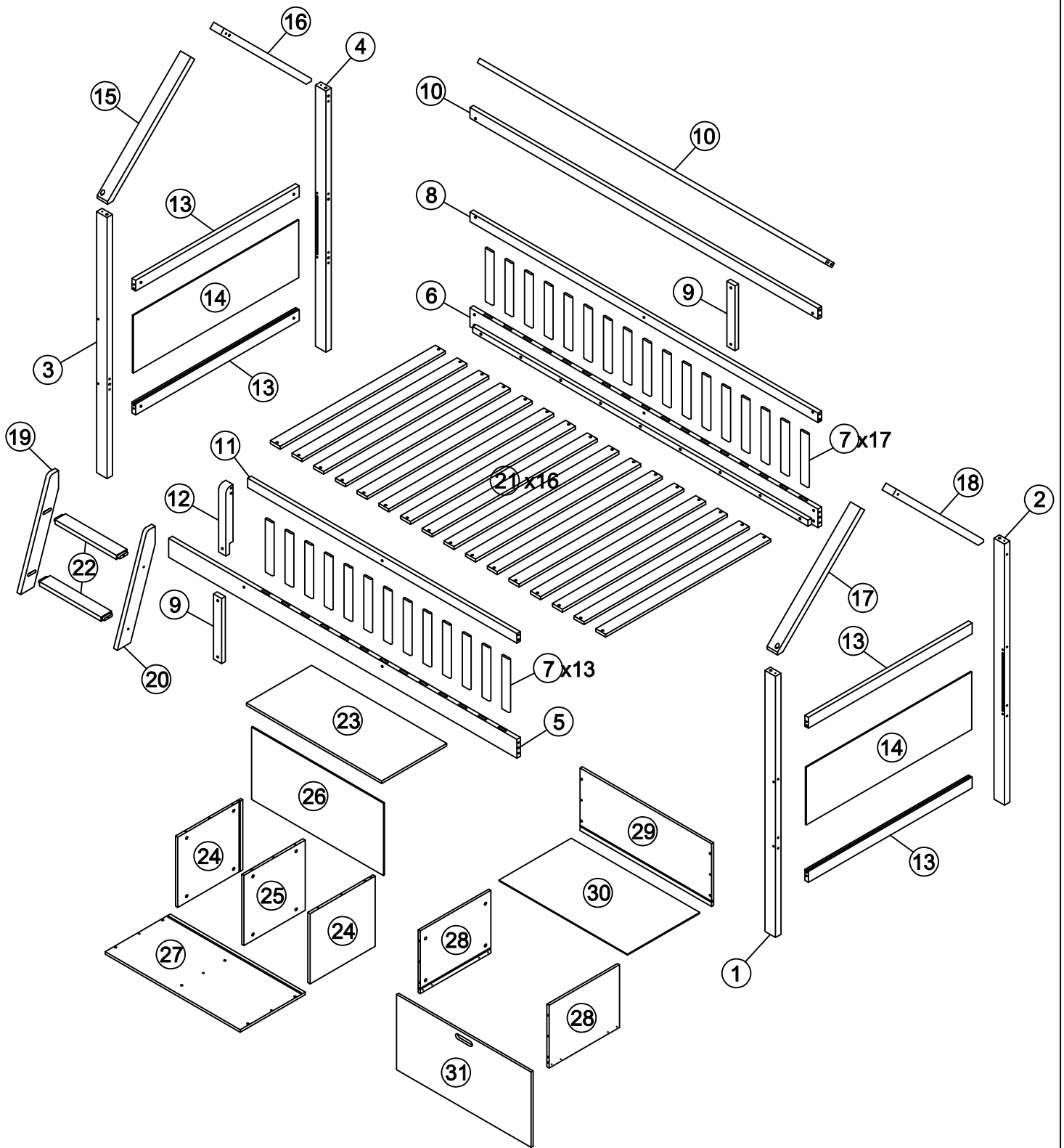

WF322686/WF322687

MONTAGEANLEITUNGEN

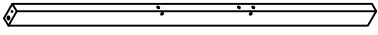

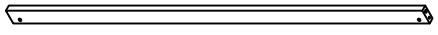
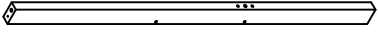

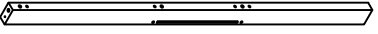
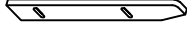
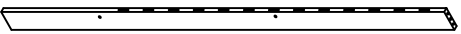
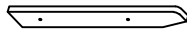
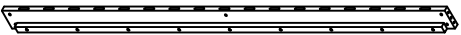
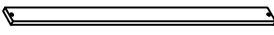

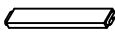





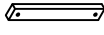

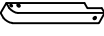
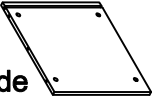
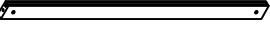
MONTAGEANLEITUNGEN

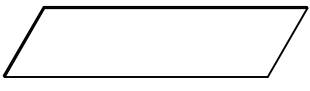
WF322686

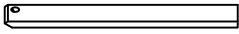

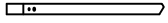
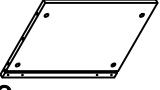
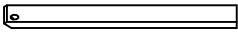

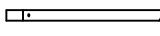
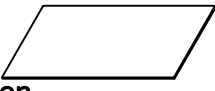







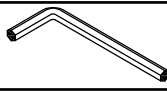

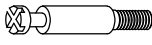

1	 Vorderbein	1pc	8	 Bettseitengitter	1pc
2	 Hinterbein	1pc	10	 Bettseitengitter	2pcs
3	 Vorderbein	1pc	11	 Bettseitengitter	1pc
4	 Hinterbein	1pc	19	 Linker Fuß der Treppe	1pc
5	 Seitenholm	1pc	20	 Rechter Fuß der Treppe	1pc
6	 Seitenholm	1pc	21	 Latten	16pcs
7	 Bettrahmen Stange	30pcs	22	 Treppenfußstütze	2pcs

MONTAGEANLEITUNGEN

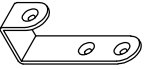
WF322687 (Hardware-in dieser SKU)

9	Bettseitenstütze		2pcs	23	Bretter auf Schubladen		1pc
12	Bettseitenstütze		1pc	24	Schubladenseitenwände		2pcs
13	Stange am Kopfteilrahmen		4pcs	25	Brett zwischen den Schubladen		1pc
14	Kopfteil		2pcs	26	Schubladenboden		1pc
15	Dachsockel		1pc	27	Bretter unter Schubladen		1pc
16	Dachsockel		1pc	28	Schubladenseitenwände		2pcs
17	Dachsockel		1pc	29	Schubladenrückwand		1pc
18	Dachsockel		1pc	30	Schubladenboden		1pc
				31	Schubladenfrontplatte		1pc

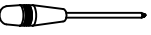

HARDWARE-LISTE (WF322687)

A	Ø0.4x3		40PCS	J	Ø0.8x3		10PCS
B	Ø0.4x1.5		6PCS	K	0.4x5.8		1PC
C	Ø0.35x1.2		8PCS	L	Ø0.65x3.5		20PCS
D	0.63x10		15PCS	M	Ø1.2x1		20PCS
E	0.63x9		1PC	N			4PCS
F	0.63x7.5		8PCS	O	7x1.8x0.2		2PCS
G	0.63x5.5		4PCS	P	Ø4.3x2x2.5		4PCS
H	0.63x3.5		5PCS	Q	0.65x6		6PCS
I	Ø1x4		18PCS		Benötigte Werkzeuge (nicht von uns gestellt)		

MONTAGEANLEITUNGEN

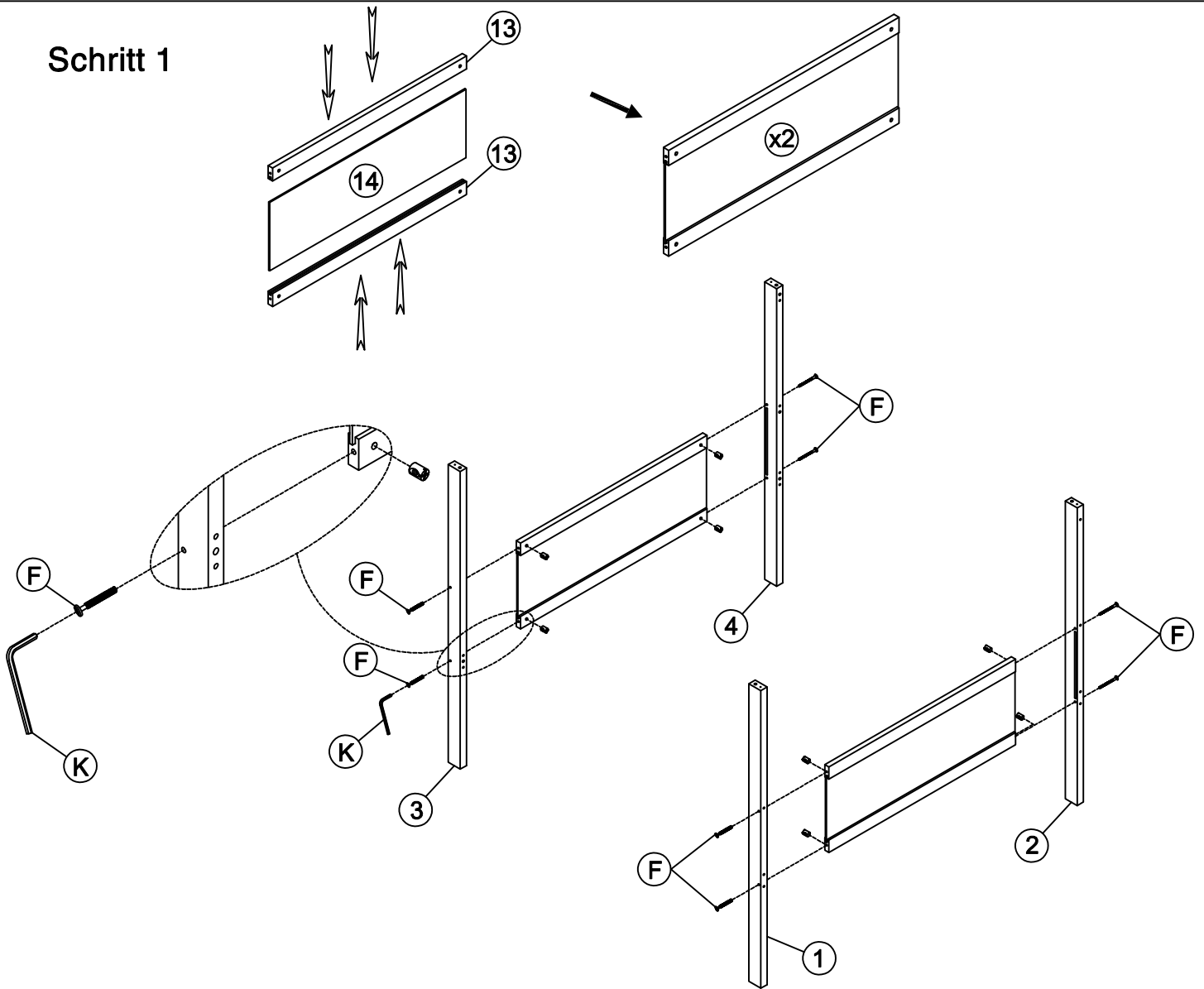
Schritt 1



F	0.63x7.5		8PCS	K	0.4x5.8		1PC
----------	----------	---	------	----------	---------	---	-----



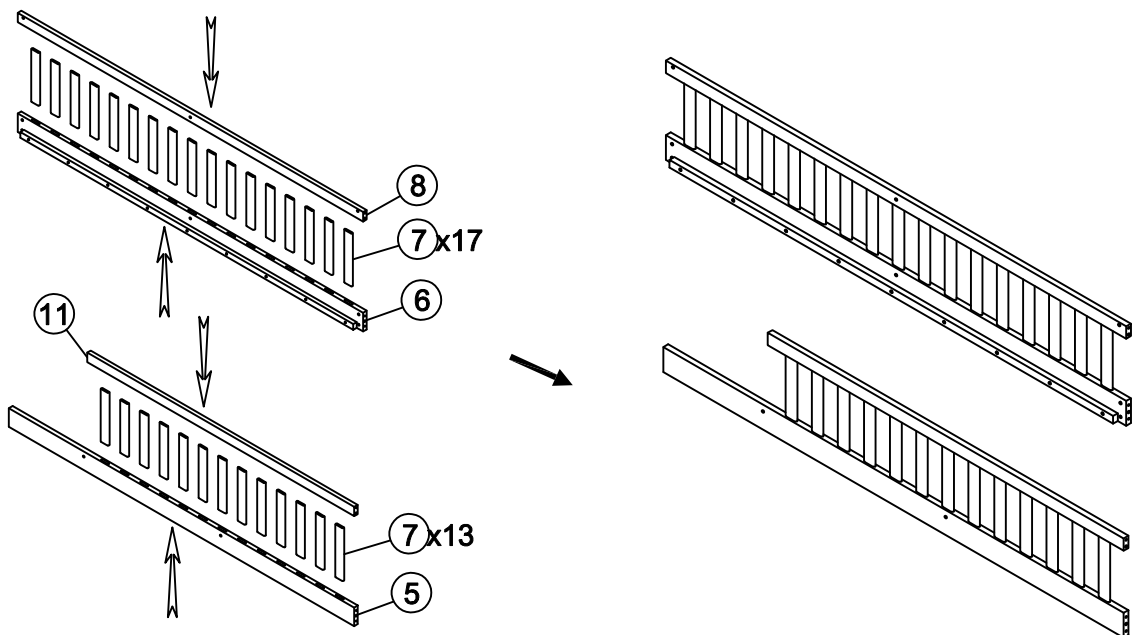

Schritt 2

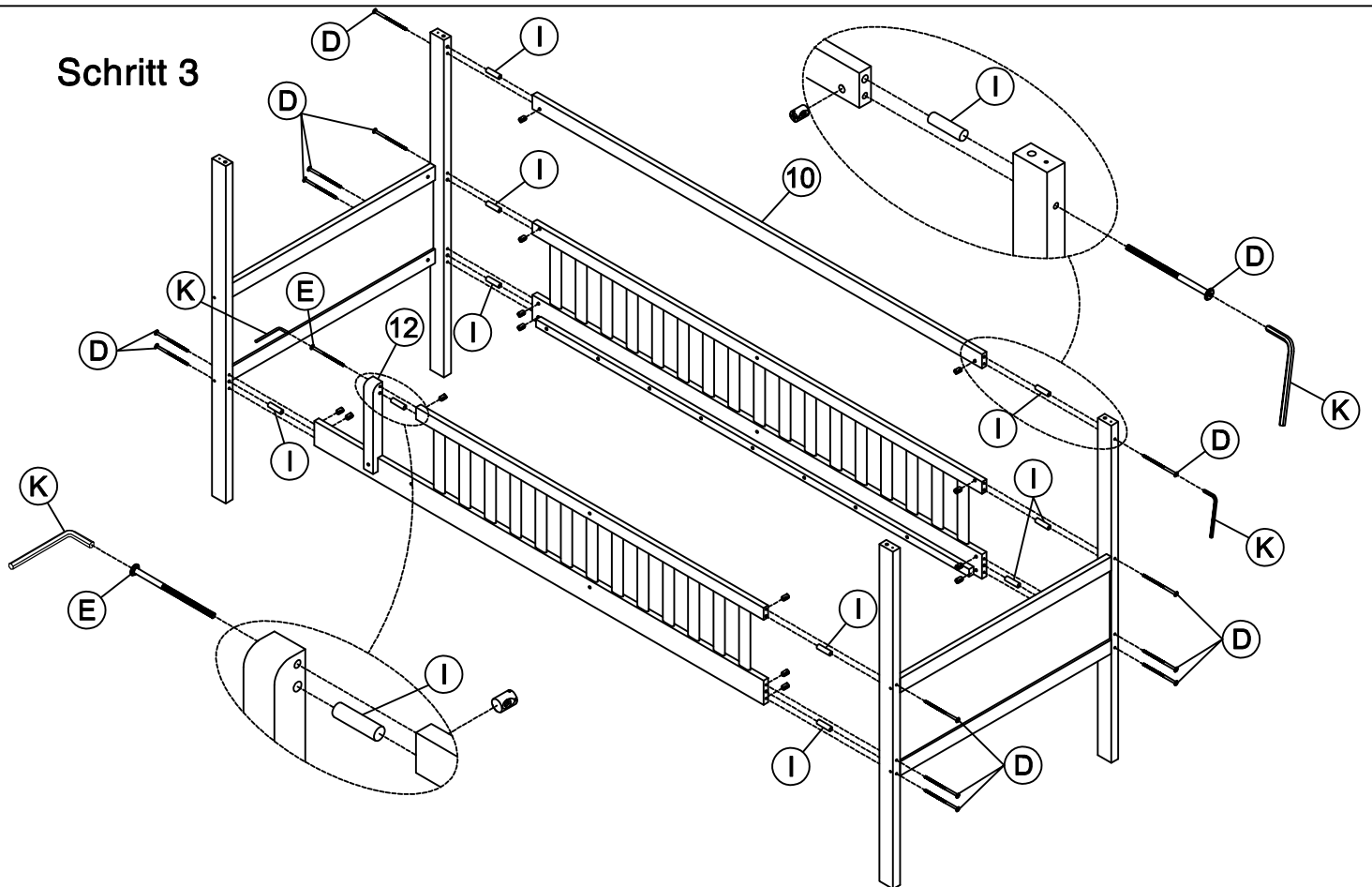

MONTAGEANLEITUNGEN



Schritt 3

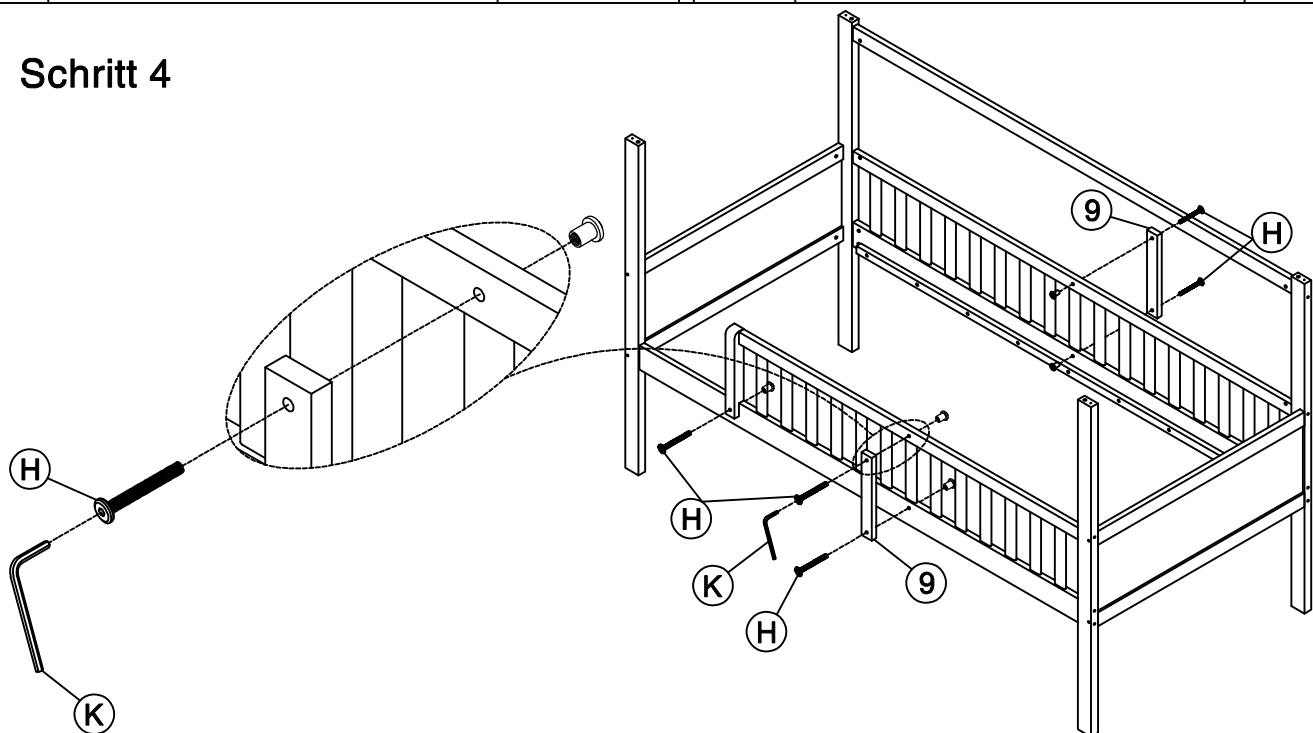

D	0.63x10		13PCS	E	0.63x9		1PC
I	Ø1x4		10PCS	K	0.4x5.8		1PC

Schritt 4

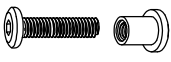



H	0.63x3.5		5PCS	K	0.4x5.8		1PC
----------	----------	---	------	----------	---------	---	-----

MONTAGEANLEITUNGEN

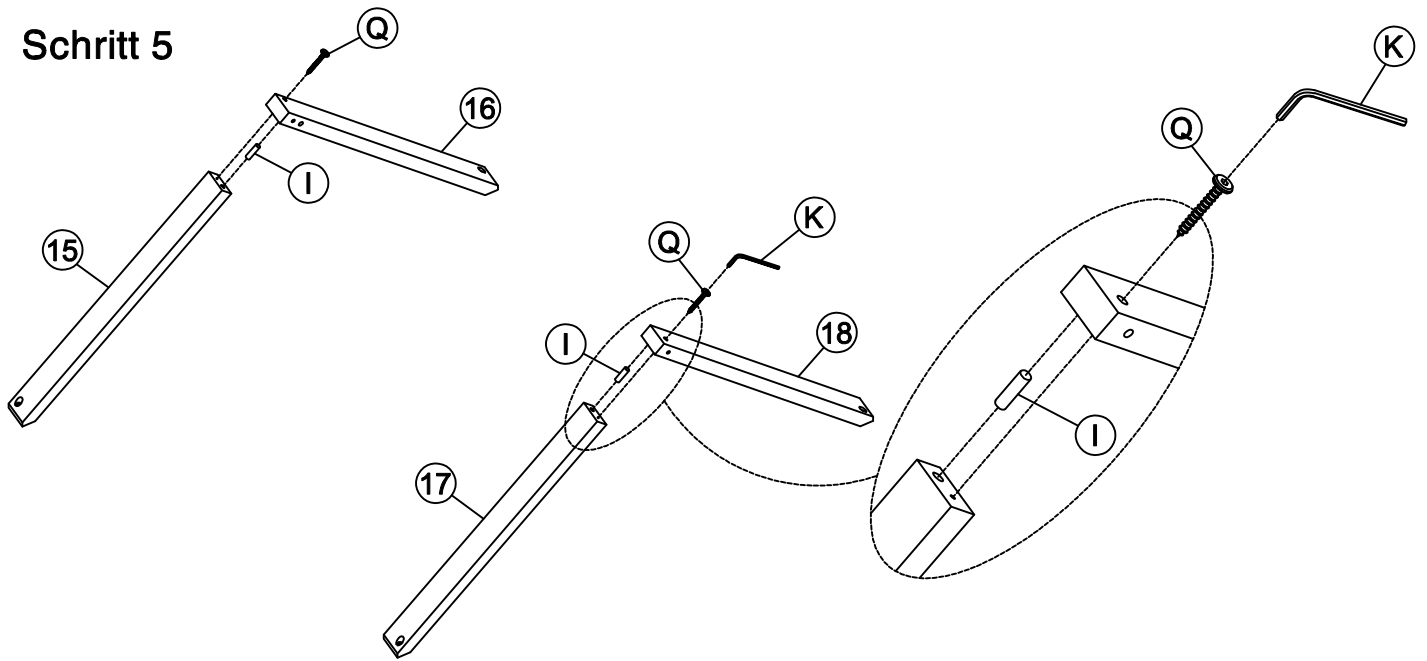

Schritt 5

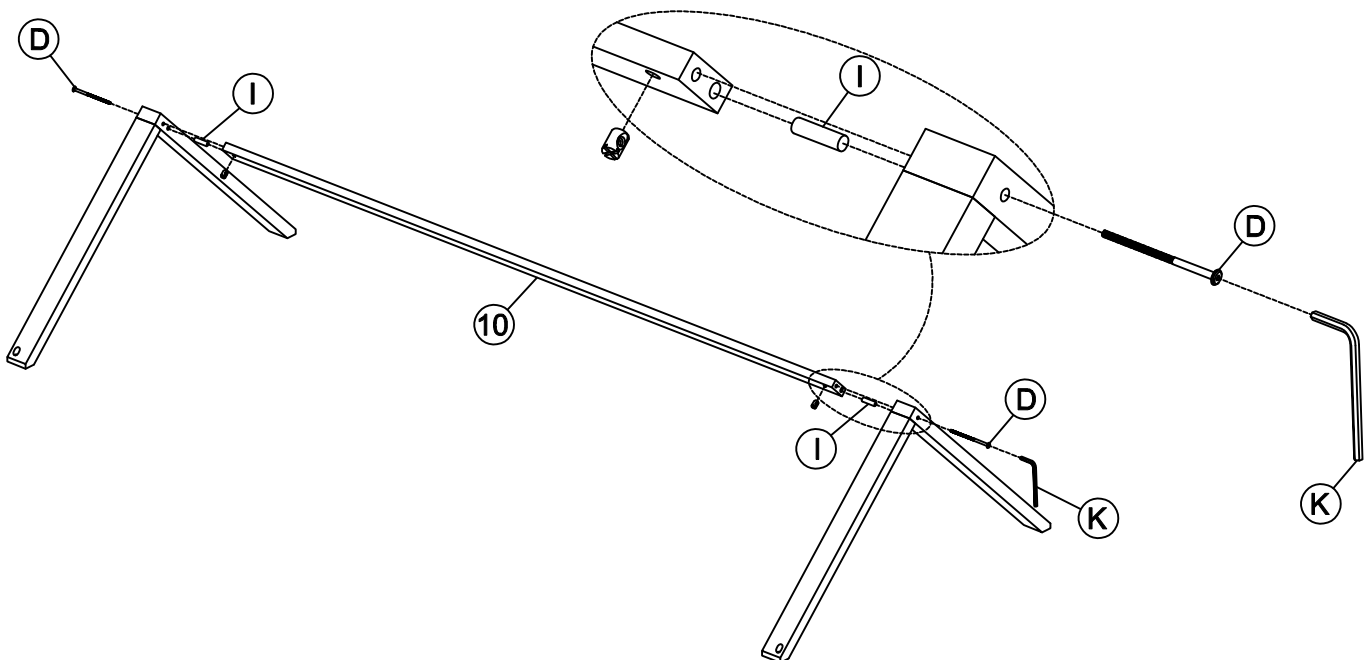

				I	Ø1x4		2PCS
Q	0.65x6		2PCS	K	0.4x5.8		1PC

Schritt 6





D	0.63x10		2PCS	I	Ø1x4		2PCS	K	0.4x5.8		1PC
----------	---------	---	------	----------	------	---	------	----------	---------	---	-----

MONTAGEANLEITUNGEN

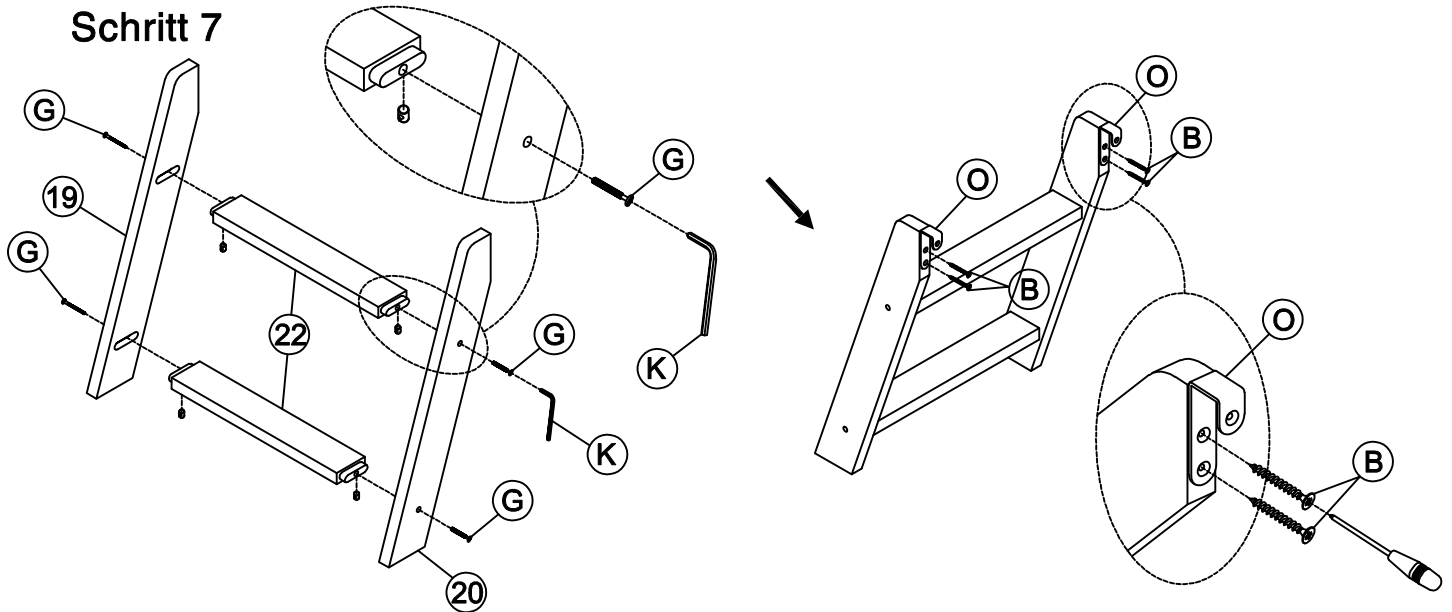

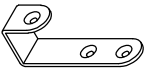

Schritt 7

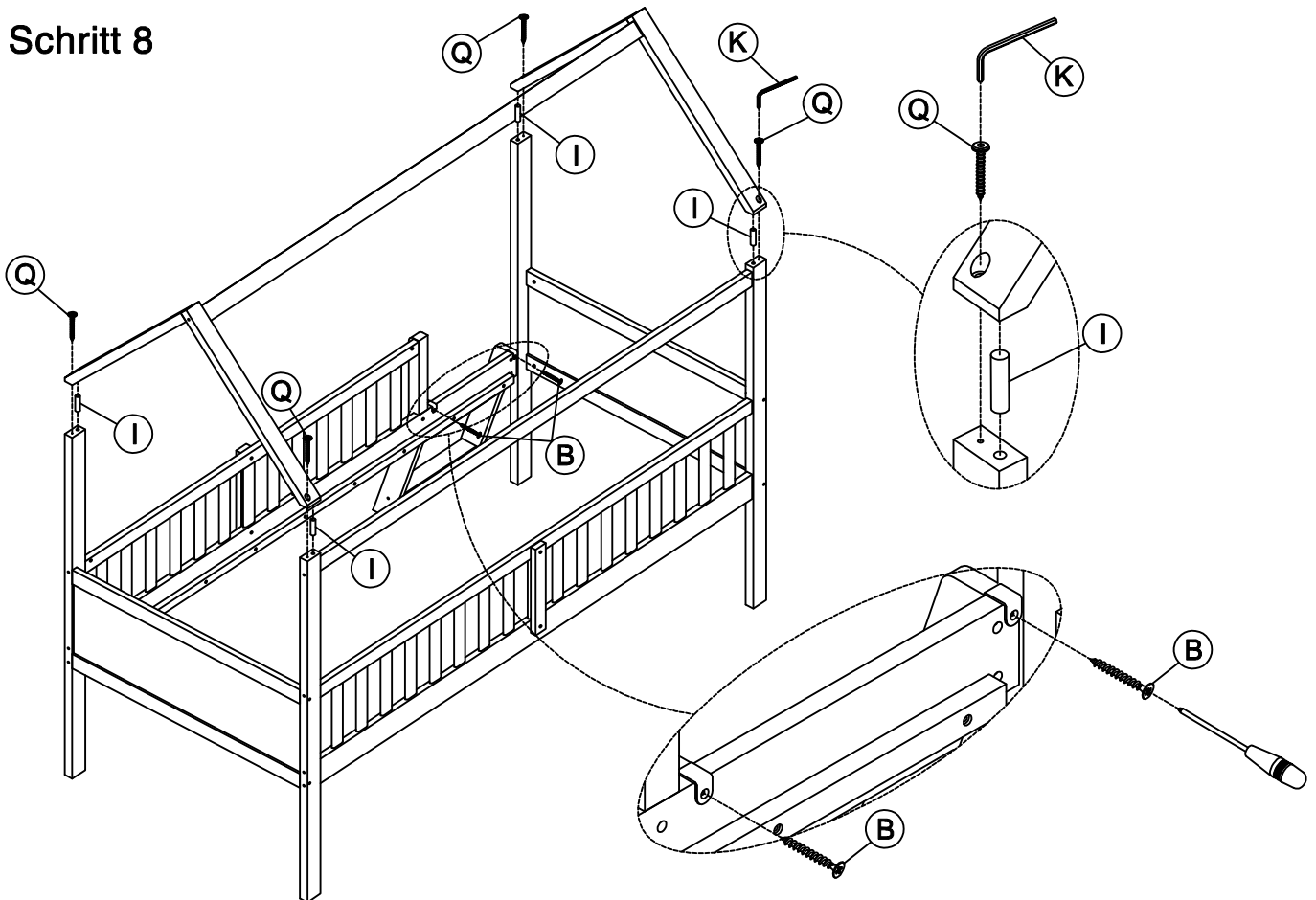

G	0.63x5.5		4PCS	K	0.4x5.8		1PC
B	Ø0.4x1.5		4PCS	O	7x1.8x0.2		2PCS

Schritt 8



I	Ø1x4		4PCS	B	Ø0.4x1.5		2PCS
Q	0.65x6		4PCS	K	0.4x5.8		1PC

MONTAGEANLEITUNGEN

Schritt 9

Befestigen Sie zunächst 2 Stück von Teil 21 an der Vorderseite und am Ende des Rahmens zwischen dem Kopfteil.

Dann befestigen Sie das restliche Teil 21 gleichmäßig zwischen dem Kopfteil.

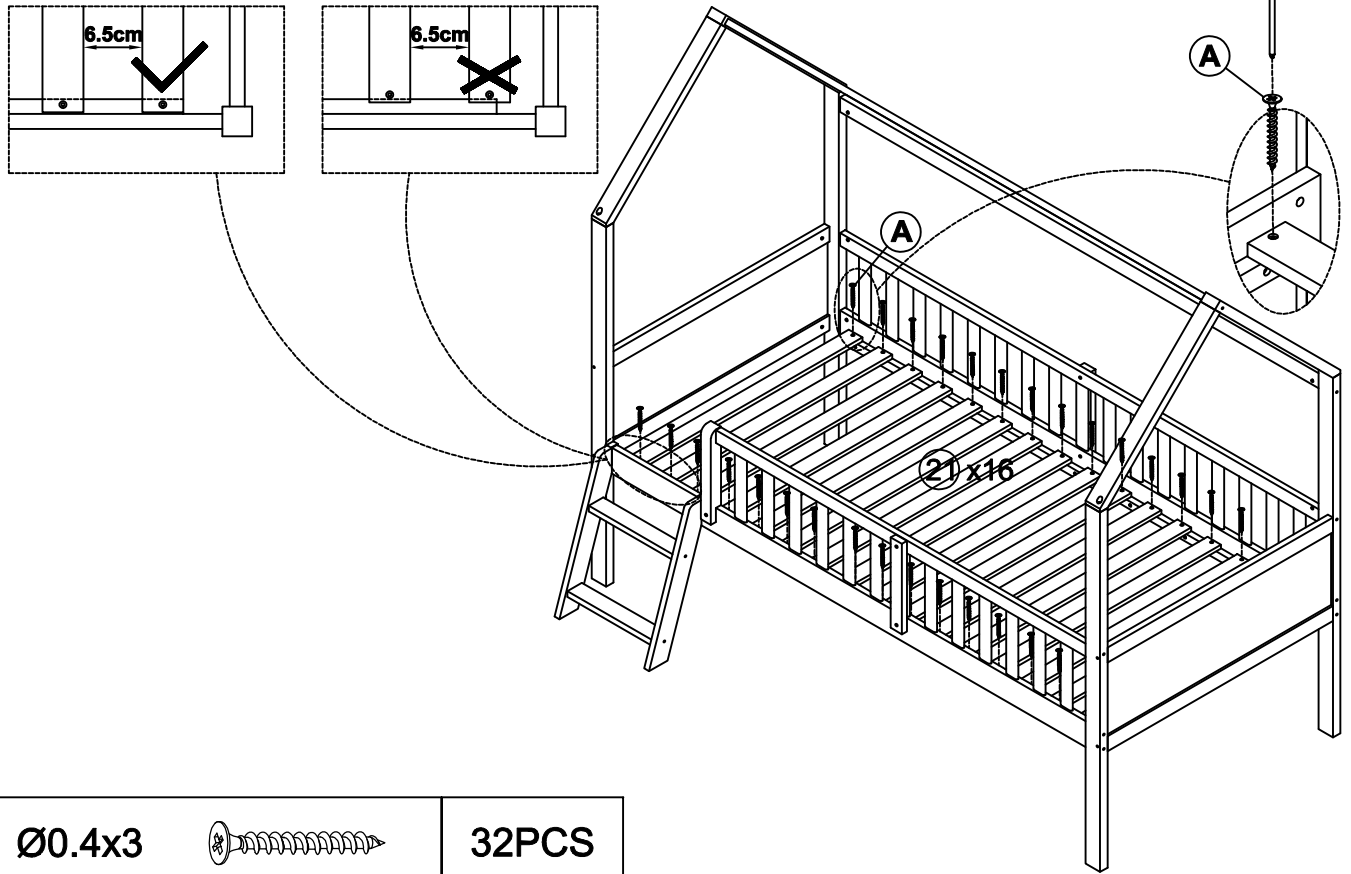

A

Ø0.4x3



32PCS

Schritt 10

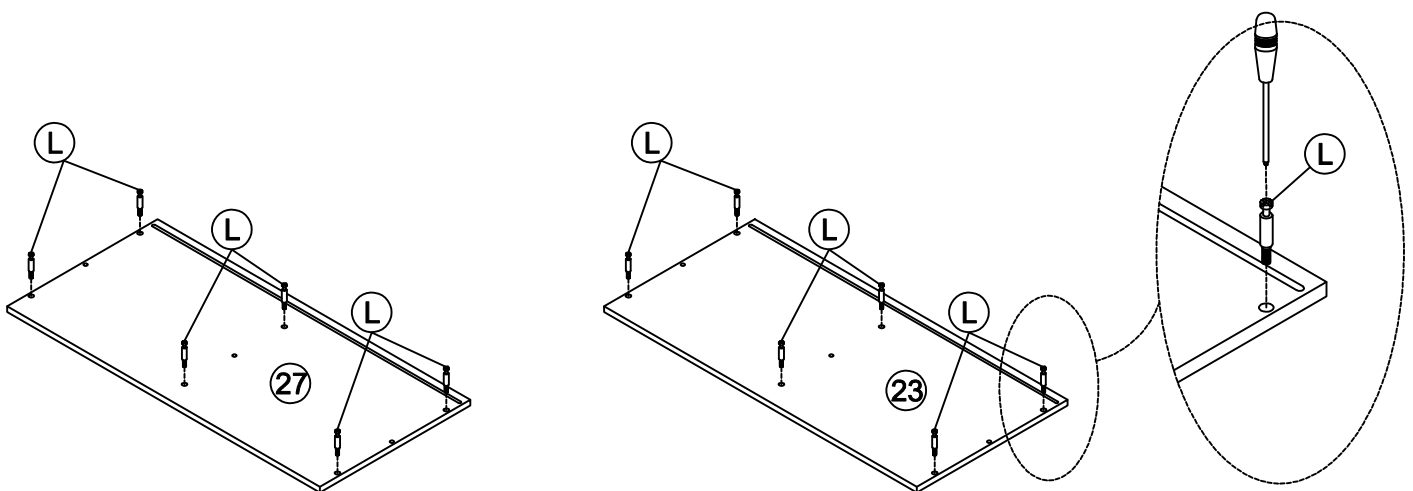

L

Ø0.65x3.5

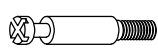



12PCS

MONTAGEANLEITUNGEN

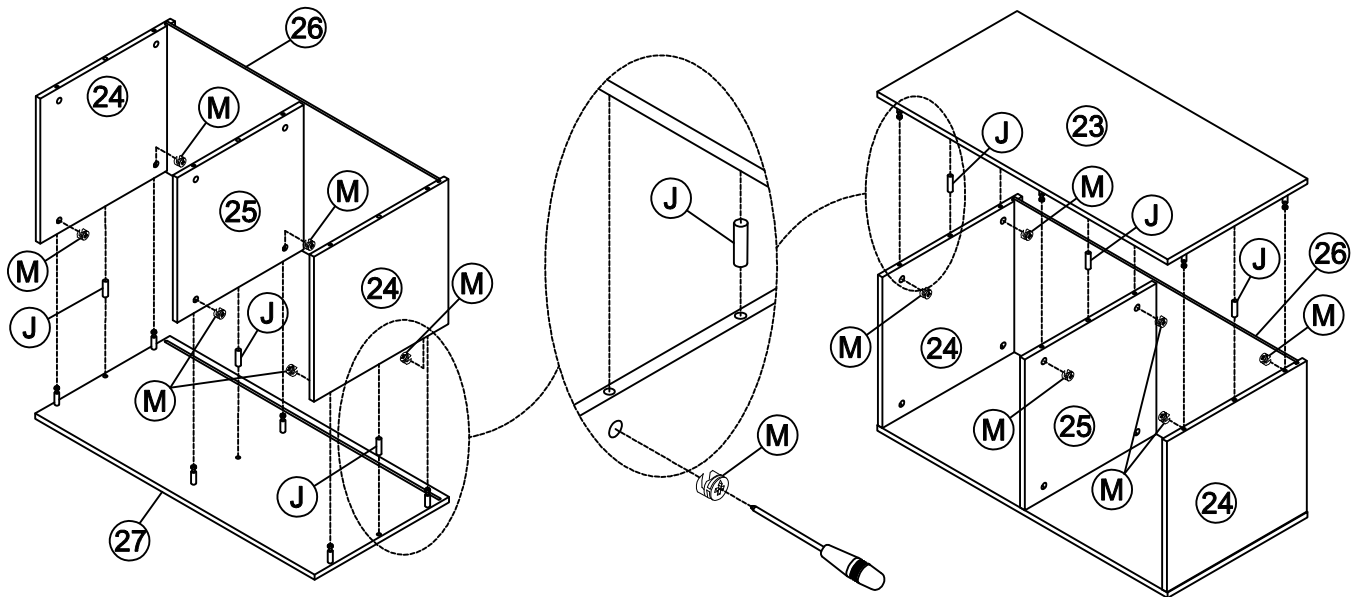

Schritt 11

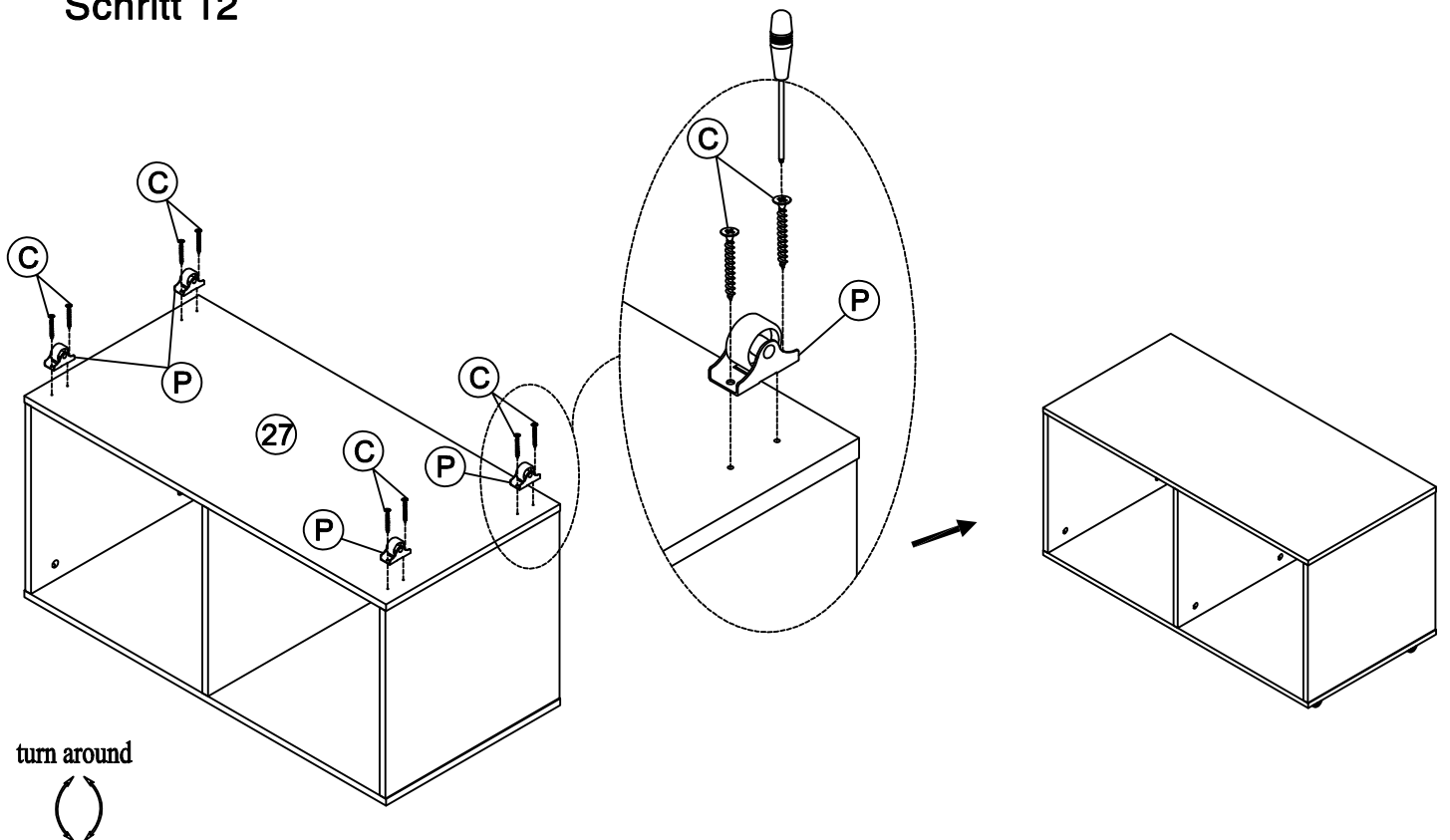

M	Ø1.2x1		12PCS	J	Ø0.8x3		6PCS
----------	--------	--	-------	----------	--------	---	------

Schritt 12



C	Ø0.35x1.2		8PCS	P	Ø4.3x2x2.5		4PCS
----------	-----------	---	------	----------	------------	---	------

MONTAGEANLEITUNGEN



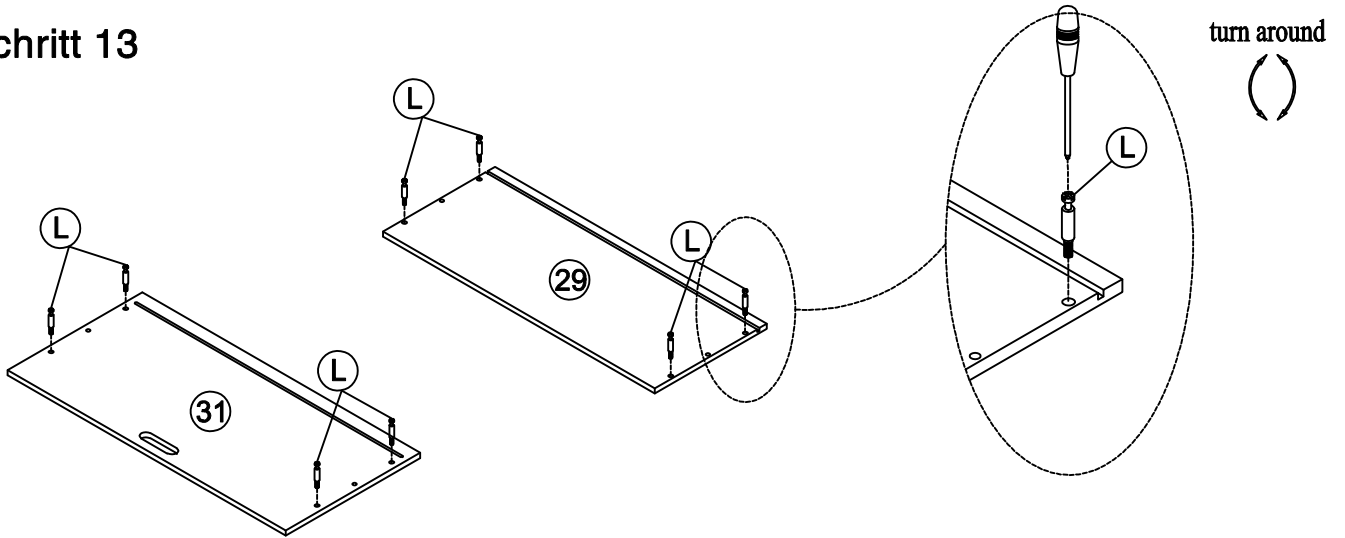

Schritt 13

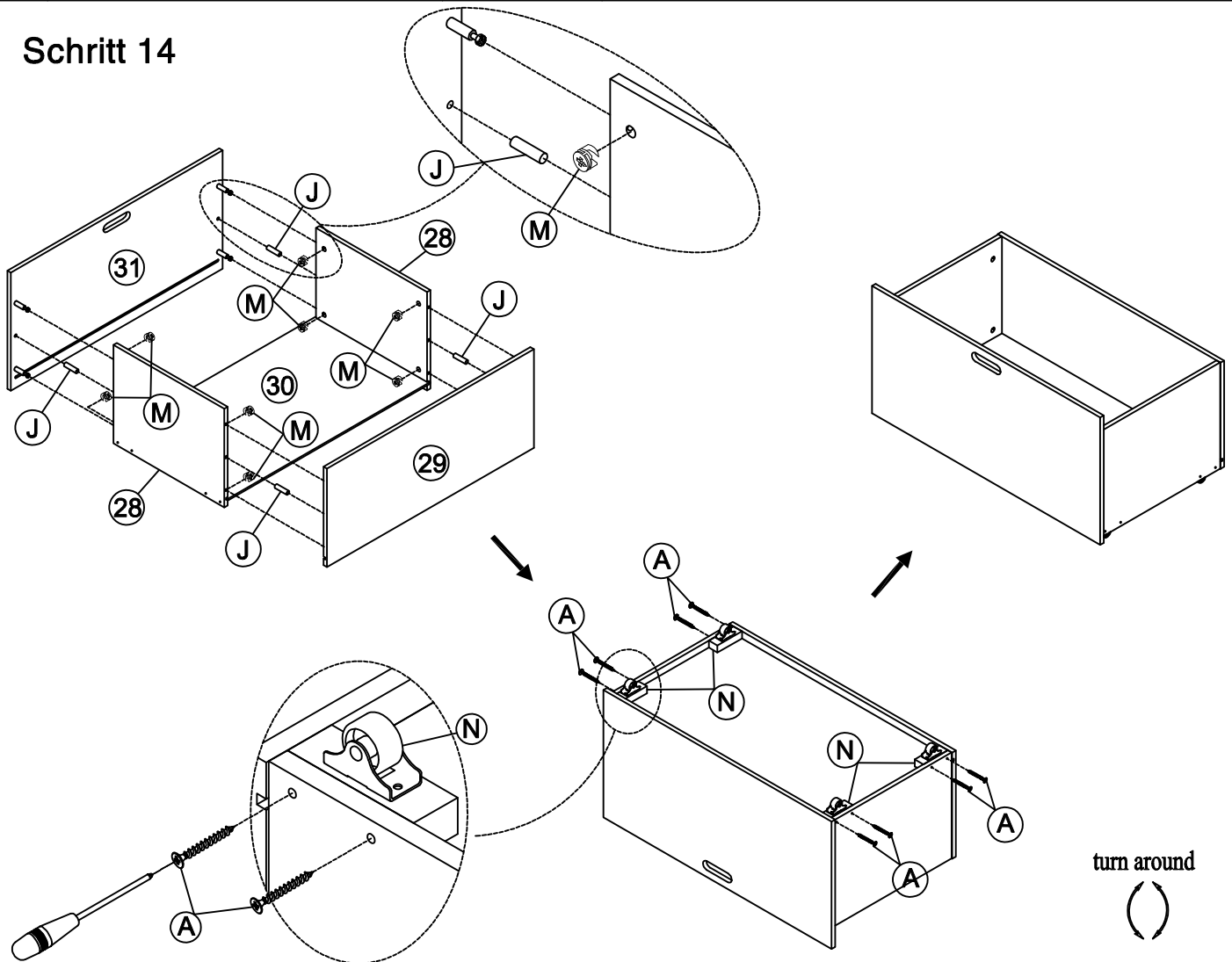

L $\text{\O}0.65 \times 3.5$  **8PCS**

Schritt 14



M	$\text{\O}1.2 \times 1$		8PCS	A	$\text{\O}0.4 \times 3$		8PCS
N			4PCS	J	$\text{\O}0.8 \times 3$		4PCS

MONTAGEANLEITUNGEN

Schritt 15

