

# MONTAGEANLEITUNG

Artikelnummer:WF316221WAA

## Nachttisch W40xH50xD35cm

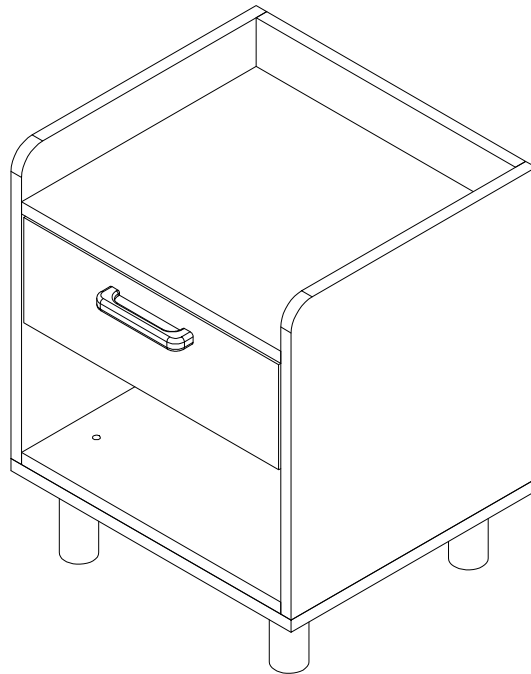

**D** Gebrauchsanweisung

**NL** Gebruiksrichtlijnen

**IT** Istruzioni per l'uso

**CZ** Pokyny k použití

**HU** Használati útmutató

**PT** Instruções de utilização

**SK** Pokyny k použitiu

**GB** Instructions for use

**FR** Instructions d'utilisation

**PL** Instrukcja obsługi

**ES** Instrucciones de empleo

**RO** Instrucțiuni de folosire

**RU** Инструкция по монтажу

**TR** Kullanım talimatları

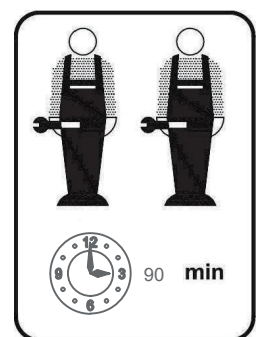

**FR - Notice de montage / EN - Assembly instructions / PT - Instruções de montagem /  
ES - Prospecto de montaje / DE - Montageanleitung / IT - Istruzioni di montaggio /  
NL - Montagehandleiding**

**FR - IMPORTANT! CONSERVER POUR CONSULTATION ULTERIEURE: LIRE ATTENTIVEMENT**

- A monter par un adulte. Un adulte doit vérifier le bon assemblage avant l'emploi
- ATTENTION! tenir les vis et petits éléments et sachets hors de portée des enfants
- Bien identifier les éléments avant de commencer le montage
- Ne pas utiliser votre article lorsque l'un de ses éléments est cassé ou manquant
- En cas de problème contactez notre service après-vente
- Toujours suivre les instructions du fabricant
- Entretien: nettoyer avec un chiffon doux et sec. En cas de taches plus grosses, frottez soigneusement avec une éponge légèrement humide et non abrasive
- Ne pas sauter sur le lit

**EN - IMPORTANT! KEEP FOR FUTURE REFERENCE: READ CAREFULLY**

- To be assembled by an adult. Assembly must be checked by an adult before use
- WARNING! keep all screws, small parts and plastic bags out of the reach of children
- Properly identify all parts before assembling
- Never use your item if any of its parts are broken or missing
- Should any problems arise, please contact our After Sales Service
- Manufacturer's instructions shall be followed at all times
- Care: clean with a soft, dry cloth. In case of larger stains, carefully rub with a slightly damp, non-abrasive sponge
- Do not jump on the bed

**PT - IMPORTANTE! GARDE PARA CONSULTA POSTERIOR: LER ESTAS INSTRUÇÕES CUIDADOSAMENTE**

- A ser montado por um adulto. Um adulto deve verificar a boa montagem antes da utilização
- Atenção! mantenha os parafusos, acessórios pequenos e saco de plástico fora do alcance das crianças
- Identifique bem os acessórios antes de começar a montagem
- Não utilizar o artigo se um dos elementos está em falta ou danificado
- Para qualquer esclarecimento, contacte os nossos serviços através do telefone
- As instruções do fabricante devem ser sempre cumpridas
- Manutenção: limpe com um pano macio e seco. Em caso de manchas maiores, esfregue cuidadosamente com uma esponja ligeiramente húmida e não abrasiva
- Não salte na cama

**ES - IMPORTANTE! CONSERVAR PARA FUTURAS CONSULTAS: LEER DETENIDAMENTE**

- A montar por un adulto. Un adulto debe comprobar el buen montaje antes de la utilización
- ¡ADVERTENCIA! mantener los tornillos, los pequeños elementos y bolsitas fuera del alcance de los niños
- Identificar debidamente los elementos antes de empezar el montaje
- No utilizar este artículo si uno de los elementos falta o esta roto
- Si tiene problemas, contactar nuestro servicio postventa
- Deben seguirse siempre las instrucciones del fabricante Cuidados: limpiar con un paño suave y seco. En caso de manchas grandes, frotar con cuidado utilizando una esponja húmeda no abrasiva
- No saltar sobre la cama

**DE - WICHTIG! FÜR SPÄTERE BEZUGNAHME AUFBEWAHREN: SORGFÄLTIG LESEN**

- Von einem Erwachsenen zu montieren. Die korrekte Montage muss vor Gebrauch von einem Erwachsenen geprüft werden
- Achtung! die Schrauben und kleinen Teile ausserhalb der Reichweite von Kindern lagern
- Vor Montagebeginn alle Teile identifizieren
- Ihren Artikel nicht benutzen, wenn eines seiner Bestandteile beschädigt ist oder fehlt
- Im Problemfall Ihren Kundendienst anrufen
- Stets die Herstelleranweisungen beachten
- Wartung: Mit einem weichen, trockenen Tuch reinigen. Bei größeren Flecken vorsichtig mit einem leicht feuchten, nicht scheuernden Schwamm abreiben
- Nicht auf dem Bett springen

**IT - IMPORTANTE! CONSERVARE QUESTE INFORMAZIONI PER ULTERIORI CONSULTAZIONI: LEGGI ATTENTAMENTE**

- Il montaggio deve essere eseguito da un adulto. Un adulto dovrà verificare il corretto montaggio prima dell'uso
- ATTENZIONE! tenere le viti ed i componenti di piccole dimensioni lontano dalla portata dei bambini
- Controllare i pezzi prima del montaggio
- L'articolo non deve essere utilizzato in caso di elementi mancanti o danneggiati
- In caso di necessità contattare il nostro servizio post-vendita
- Seguire sempre le istruzioni del costruttore
- Manutenzione: pulire con un panno morbido e asciutto. Per le macchine più grandi, strofinare accuratamente con una spugna leggermente umida e non abrasiva
- Non saltare sul letto



**NL - BELANGRIJK! BEWAAR VOOR LATERE RAADPLEGING: LEES AANDACHTIG**

- Moet door een volwassene worden gemonteerd. Voor gebruik moet een volwassene controleren dat het product goed in elkaar is gezet
- WAARSCHUWING! schroeven en kleine elementen en zakjes buiten bereik van kinderen houden
- De elementen goed identificeren alvorens met de montage te beginnen
- Uw artikel niet gebruiken wanneer een van de onderdelen kapot is of ontbreekt
- Neem bij problemen contact op met onze klantenservice
- Volg altijd de instructies van de fabrikant
- Onderhoud: maak schoon met een zachte en droge doek. In geval van grotere vlekken, veeg voorzichtig schoon met een licht bevochtigde en niet-schurende spons
- Niet springen op het bed

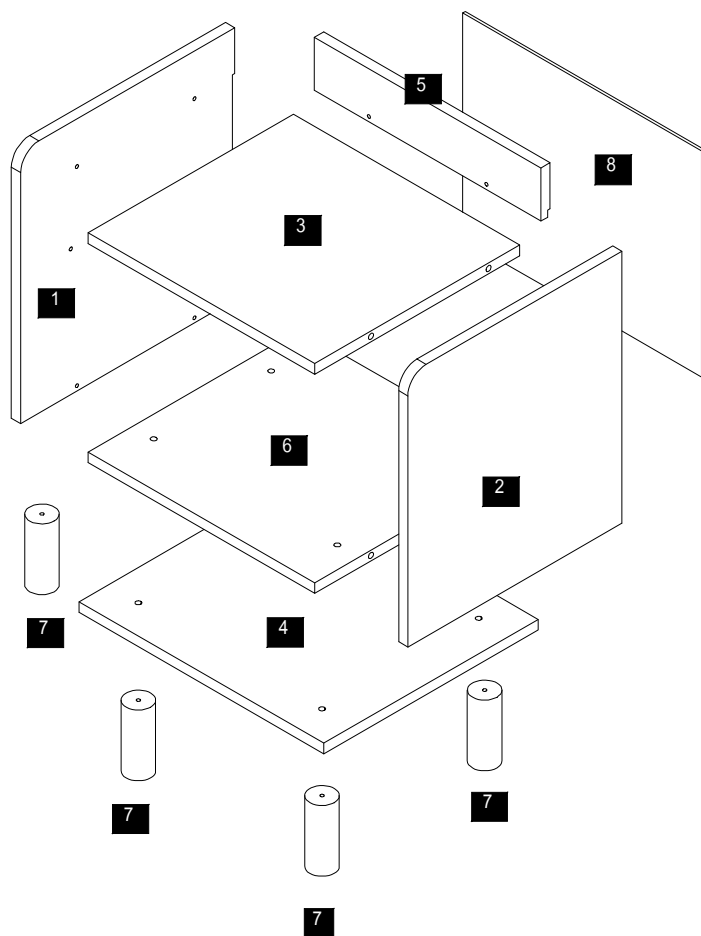
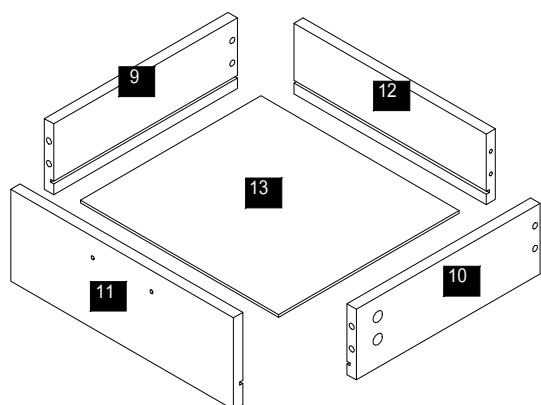



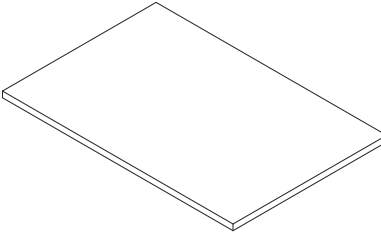
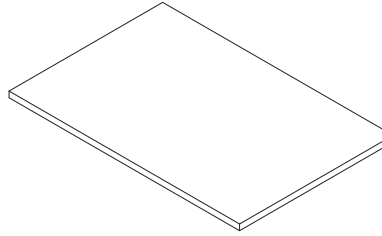
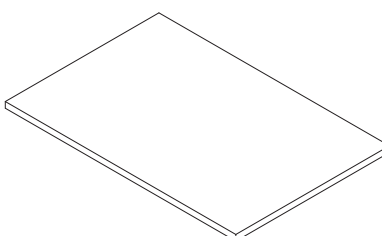
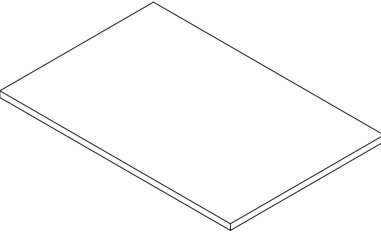
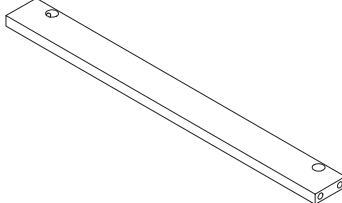
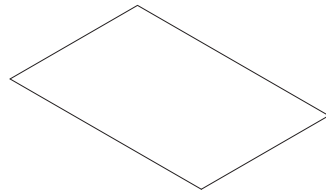

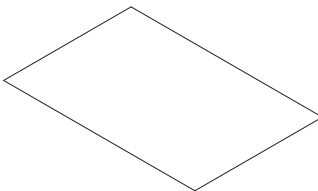
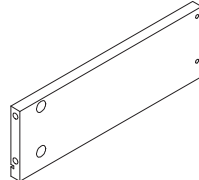
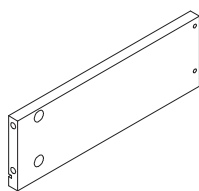
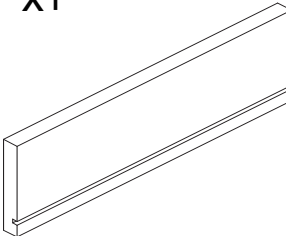
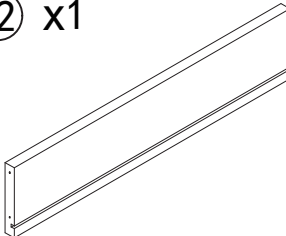
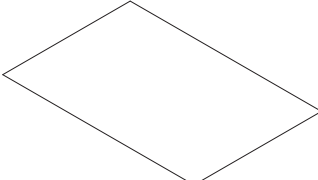

# Stückliste

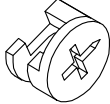
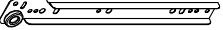
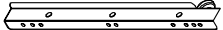

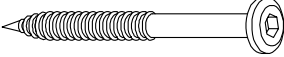
# WF316221WAA

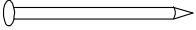

<p>① x1</p> 	<p>② x1</p> 	<p>③ x1</p> 
<p>④ x1</p> 	<p>⑤ x1</p> 	<p>⑥ x1</p> 
<p>⑦ x4</p> 	<p>⑧ x1</p> 	<p>⑨ x1</p> 
<p>⑩ x1</p> 	<p>⑪ x1</p> 	<p>⑫ x1</p> 
<p>⑬ x1</p> 		

# Hardware-Liste + WF316221WAA

A		14
B	 1510	14
C	L1  R1 L2  R2 300mm	1
D	 3*12	8
E	 $\Phi 6*50$	4
F	 3.5*25	4
G		12
H		1
J	 4*30	4
K	 4 mm	1

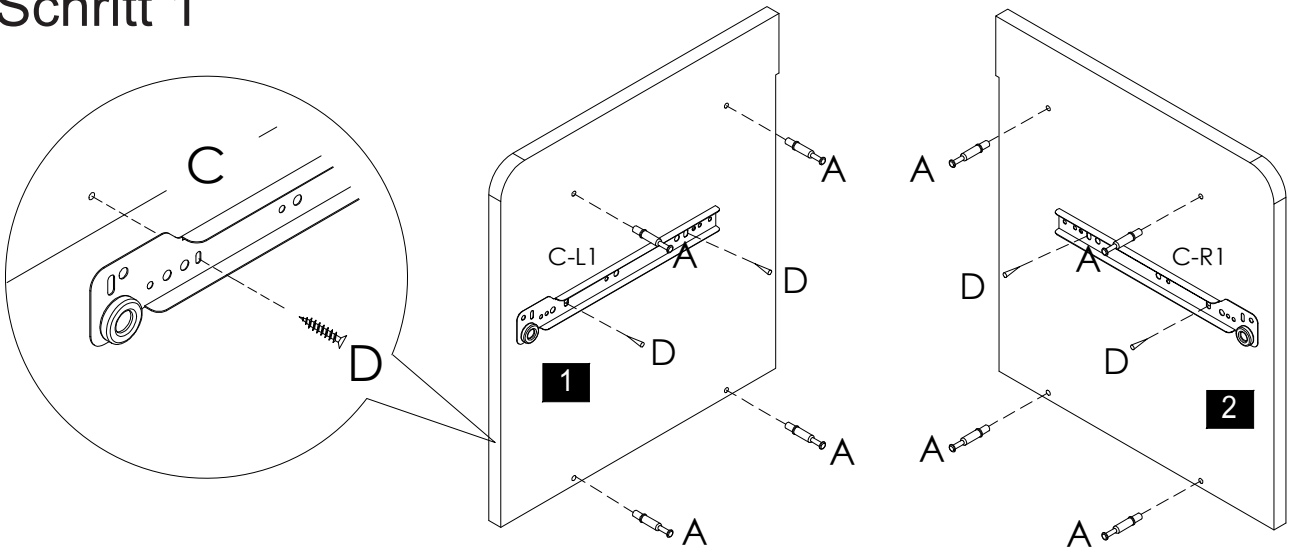
# Schritt 1

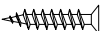

A		10
C	L1  R1 	1
D	 3*12	4

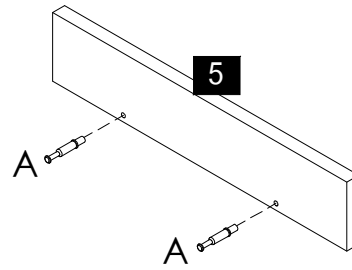

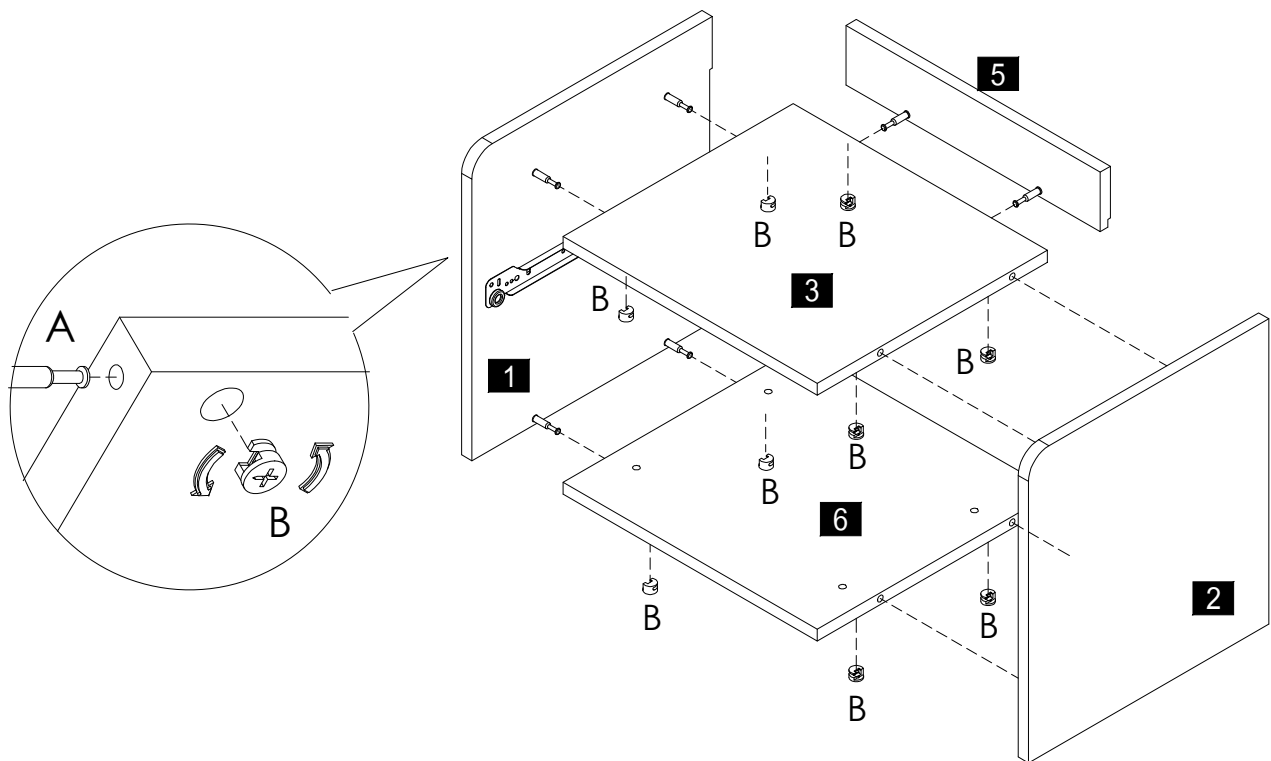

# Schritt 2

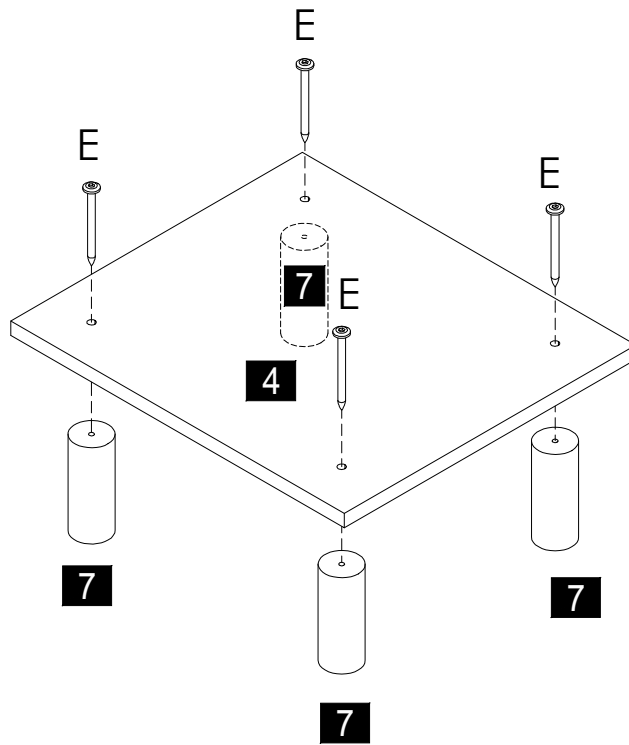

B		1510	10
---	---	------	----

# Schritt 3

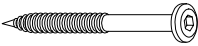

E		Φ6*50	4
K		4 mm	1

# Schritt 4

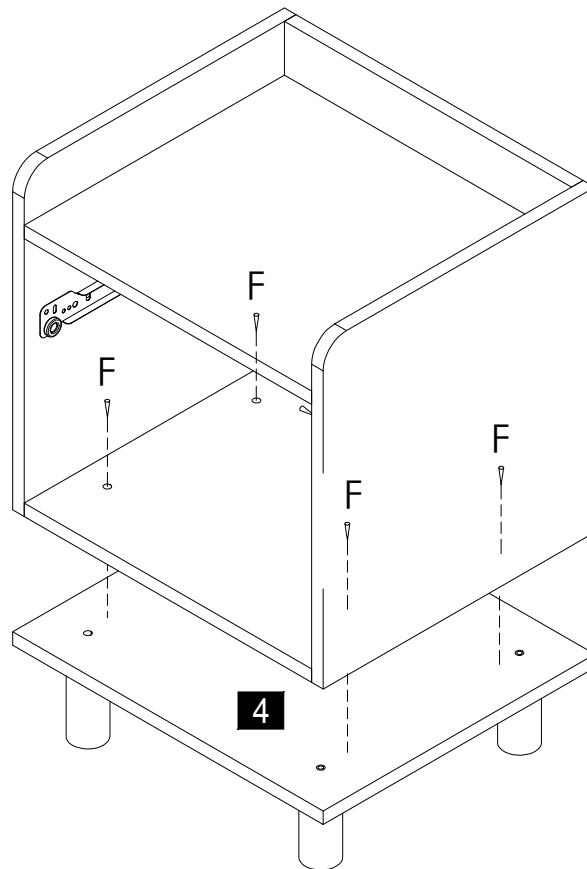

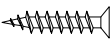
F		3.5*25	4
---	---	--------	---

## Schritt 5

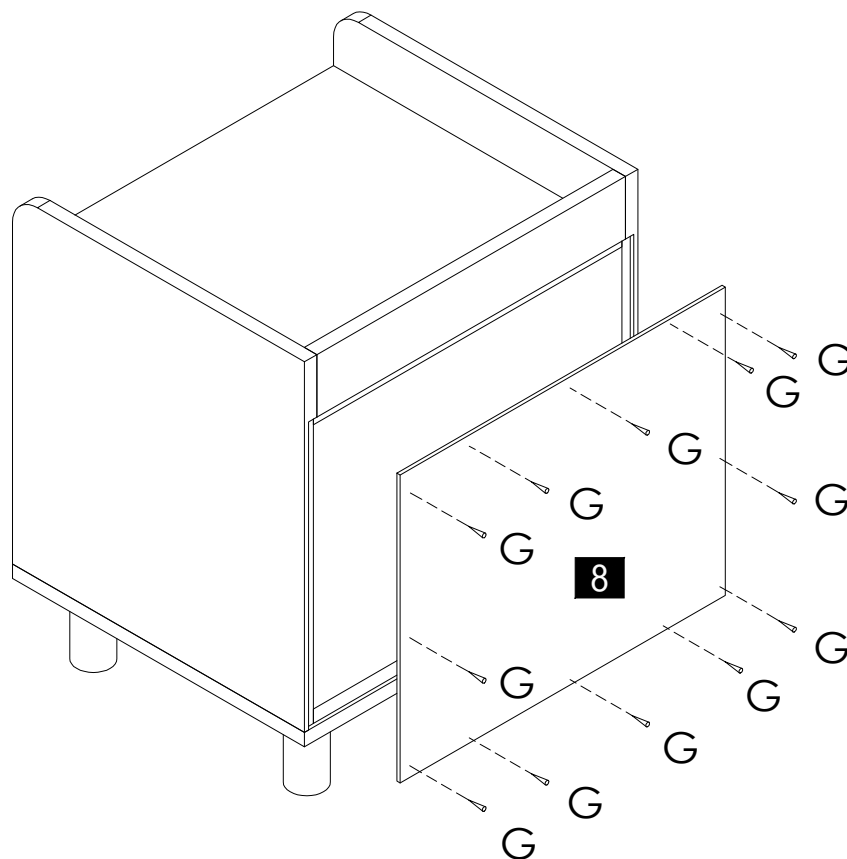

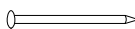
G		12
---	--	----

## Schritt 6

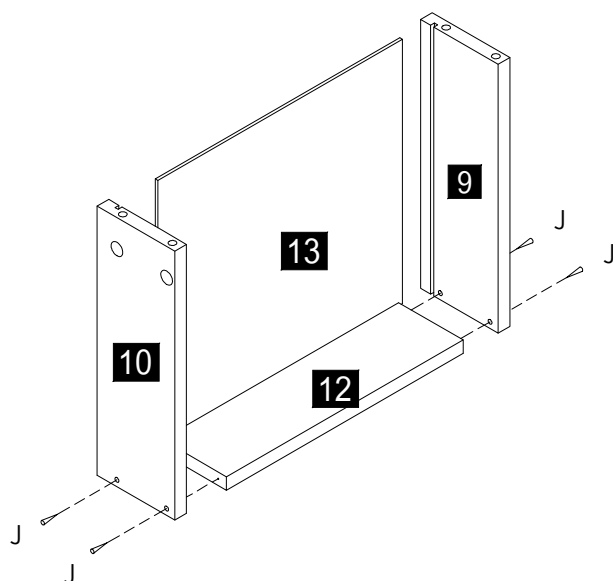





J		4*30	4
---	---	------	---

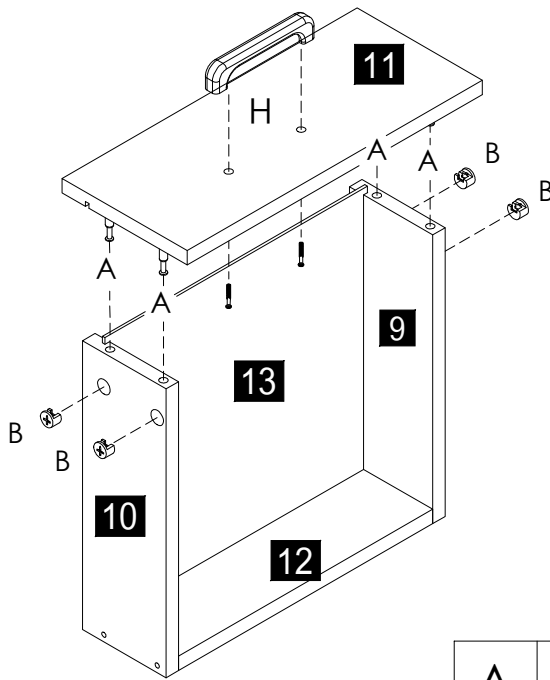

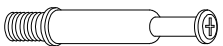
# Schritt 7

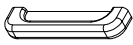

A		4
B	 1510	4
H	  	1

# Schritt 8

Montage auf Schubladenböden

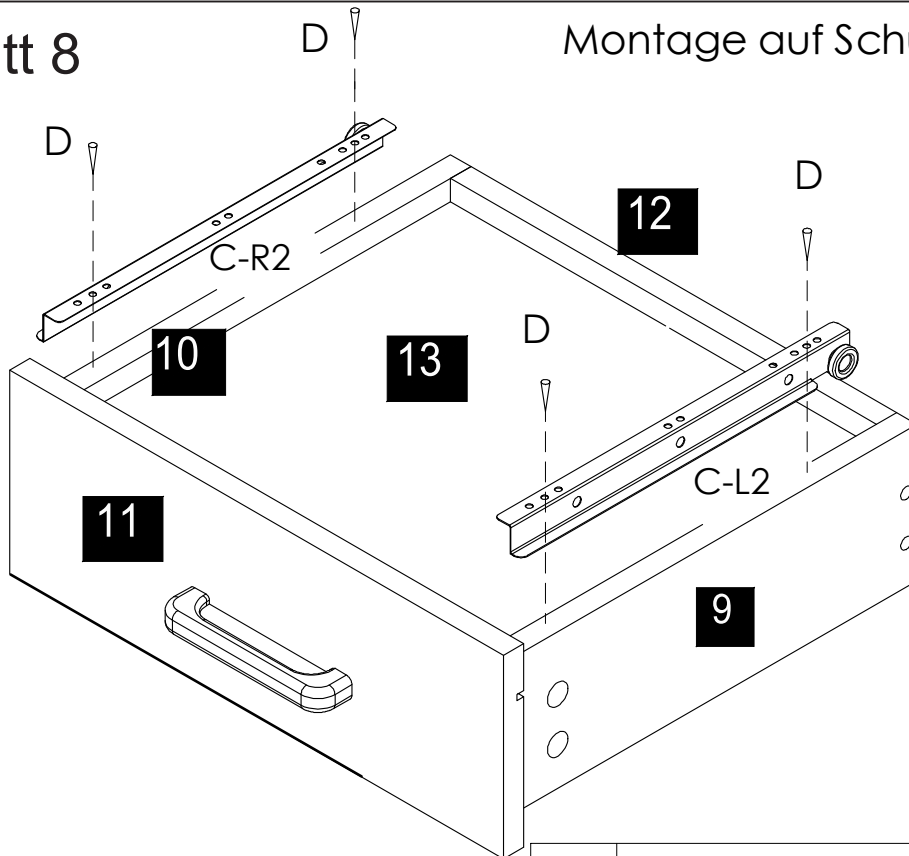

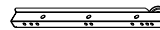
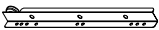
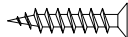
C	L2   R2	1
D	 3*12	4

## Schritt 9

