

3WSYHU52/3WSEHU52

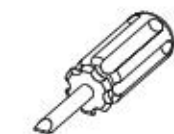

ø5

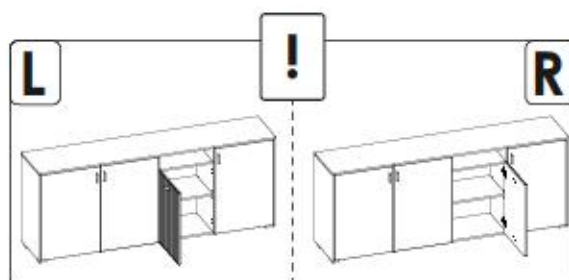
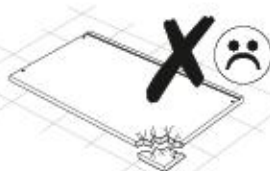
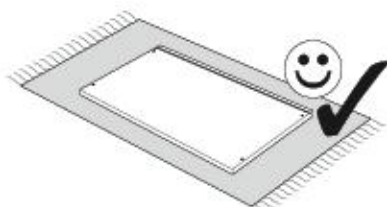
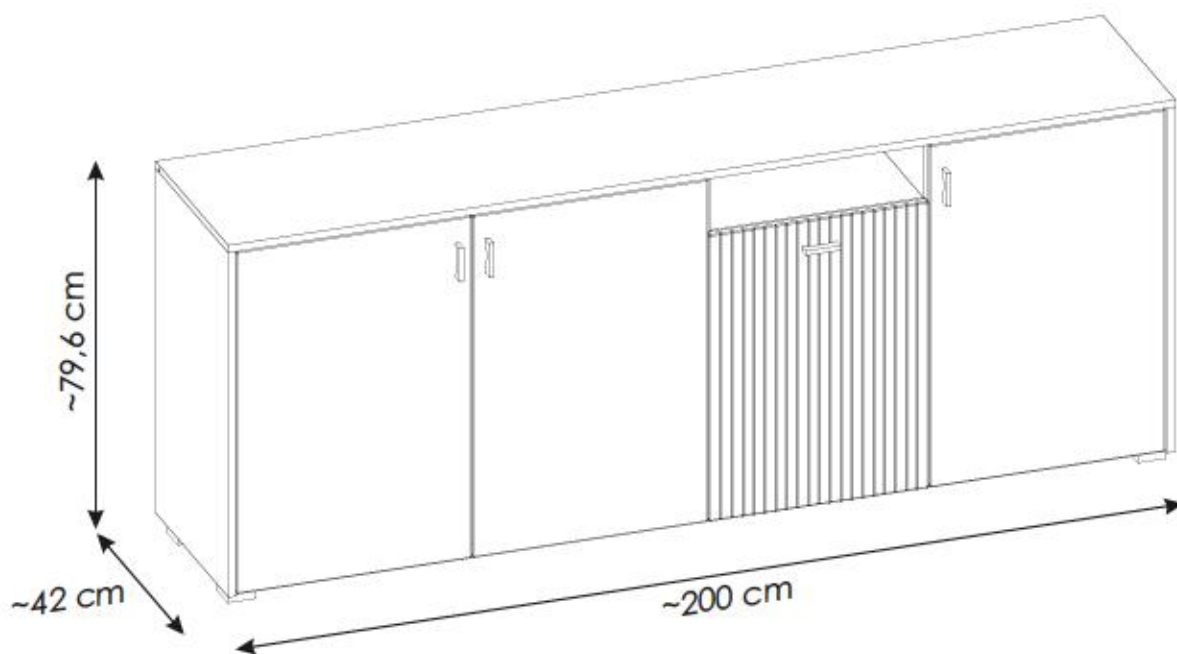

ملاحظة!

يجب تثبيت الأثاث بإحكام إلى الحائط أو الجدار لتجنب خطر إنقلابه. لا تحتوي العلبه على مسامير التثبيت، إذ إنه ينبغي إستعمال المسامير المخصصة لنوعية الحائط أو الجدار. اختر المسامير التي تناسب جدارك.

E.

¡ATENCIÓN! El mueble debe ser fijado permanentemente a la pared para evitar el riesgo relacionado con el vuelco del mueble. En el paquete no hay tornillos de fijación, ya que se debe elegir el tipo de fijación adecuado para el tipo de pared. Elija el apropiado para su tipo de pared.

CN.

注意！本家具需要固定在墙上以免倒塌。箱子里没有安装螺钉。因为安装方式需要根据墙的类型调整。请按照您的墙类型选择合适的安装方式。

SLO.

POZOR! Pohišivo trajno pritrđite na steno, da preprečite tveganje, da se prevrne. V paketu ni pritrđilnih vijakov, saj je treba način pritrđitve ustrezno izbrati glede na vrsto stene. Izberite način, ki je ustrezen za vašo steno.

HU.

FIGYELEM! Rögzítse a bútorokat a falhoz, hogy elkerülje a bútor felborulásának kockázatát. A készletben nem találhatóak rögzítőcsavarok, mivel a rögzítés típusa a fal típusától függ. Válassza ki a fal típusának megfelelő kötőelemeket.

NL.

OPMERKING! De meubelen moeten permanent aan de muur worden bevestigd om te voorkomen dat de meubelen kantelen. Er zitten geen bevestigingsschroeven in het pakket, omdat het type bevestiging moet worden gekozen op basis van het type muur. Kies de juiste voor uw type muur.

EN.

WARNING! To prevent this furniture from tripping over, fix it to the wall permanently. Fixing devices are not included since different wall materials require different types of fixing devices. Please make sure you chose the correct ones for your type of wall.

SK.

POZORI Nábytok musí byť trvalo pripevnený k stene tak, aby sa zamedzilo riziku prevrátenia. Balík neobsahuje upevňovacie skrutky, pretože typ upevnenia je treba vybrať podľa typu steny. Vyberte typ vhodný pre Vašu stenu.

CZ.

POZOR! Nábytek je nutné pevně připevnit ke zdi, abychom se vyhnuli riziku spojenému s jeho převrnutím. Součástí balení nejsou připevňovací šrouby, protože způsoby připevnění je nutné zvolit podle druhu stěny. Vyberte správný pro Váš typ stěny.

RU.

ПРИМЕЧАНИЕ! Эту мебель необходимо всегда прикреплять к стене, чтобы избежать рисков, связанных с переворотом мебели. В пакете нет крепежных винтов, потому что тип крепления должен быть выбран в соответствии с типом стены. Выберите, пожалуйста, правильные винты к вашей стене.

RO.

ATENȚIE! Mobila trebuie ancorată permanent în perete pentru a evita riscul de răsturnare a mobilei. În pachet nu sunt incluse șuruburile de fixare, deoarece tipul de ancoraj trebuie ales în funcție de tipul de perete. Alegeți șuruburile potrivite pentru tipul Dvs. de perete.

TR.

DIKKATI! Devrimle riskini önlemek için mobilya duvara sabitlenmelidir. Sabitleme civataları pakete dahil değildir, çünkü sabitleme tertibatının tipi, duvara tipine uygun olarak seçilmelidir. Onu duvannızın tipine göre seçiniz.

PL.

UWAGA! Mebel należy trwale zamocować do ściany, aby uniknąć ryzyka związanego z przewróceniem się mebla. W paczce nie ma śrub mocujących, ponieważ rodzaj mocowania należy odpowiednio dobrać do rodzaju ściany. Dobierz właściwe do Twojego rodzaju ściany.

D.

ACHTUNG! Um alle mit dem Umkippen des Möbels verbundenen Risiken auszuschließen, muss das Möbel fest an der Wand verankert werden. Beschläge für die Wandbefestigung sind nicht beige packt, da diese von der jeweiligen Wandbeschaffenheit abhängig sind. Bitte solche Befestigungsschläge wählen, die für die heimischen Wände geeignet sind.

FR.

ATTENTION! Ce meuble doit être fixé en permanence au mur pour éviter les risques de chute. Les vis de fixation ne sont pas livrées car le type de fixation doit être choisi en fonction du type de mur. Sélectionnez les fixations adaptées au mur.

I.

ATTENZIONE! Il mobile deve essere permanentemente fissato alla parete per evitare i rischi derivanti da un ribaltamento del mobile. La confezione non include le viti di fissaggio, in quanto il tipo di fissaggio deve essere scelto in base al tipo di parete. Utilizzare viti appropriate in base al materiale della parete.

HR.

NAPOMENA! Namještaj mora biti trajno pričvršćen za zid, kako bi se izbjegao rizik od njegovog prevrtanja. U paketu nema vijaka za pričvršćivanje, jer se vrsta montaže mora prilagoditi vrsti zida. Odaberite pravu vrstu prema Vašoj vrsti zida.

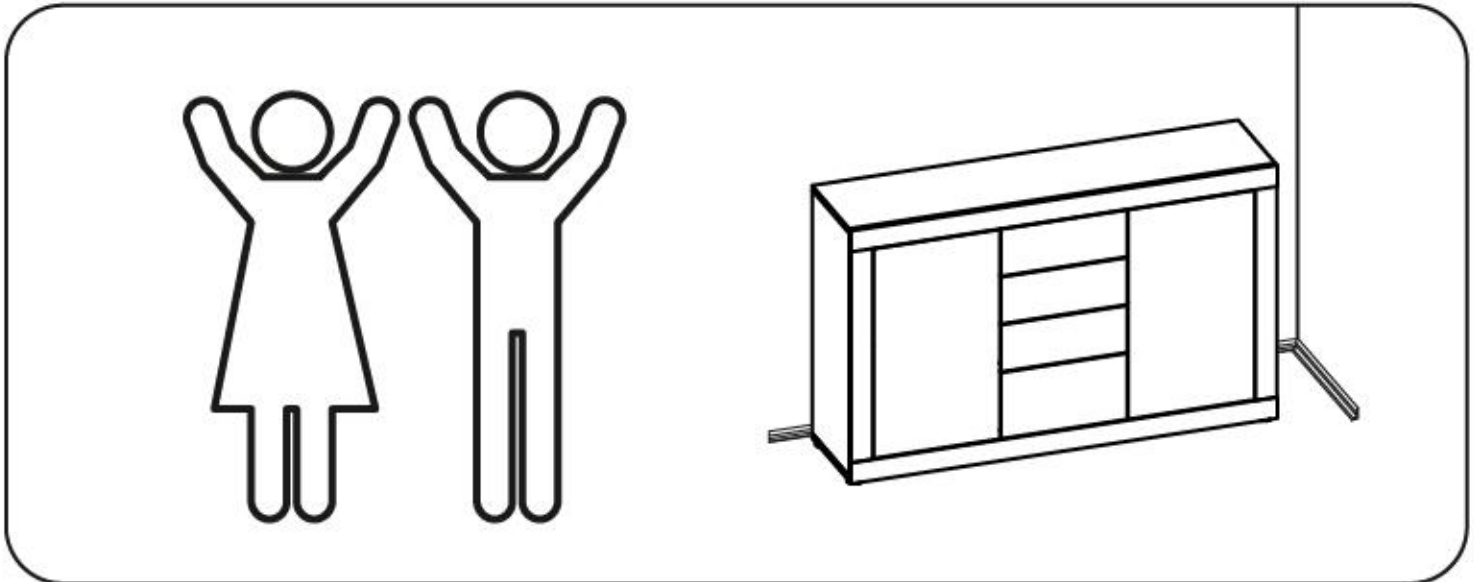
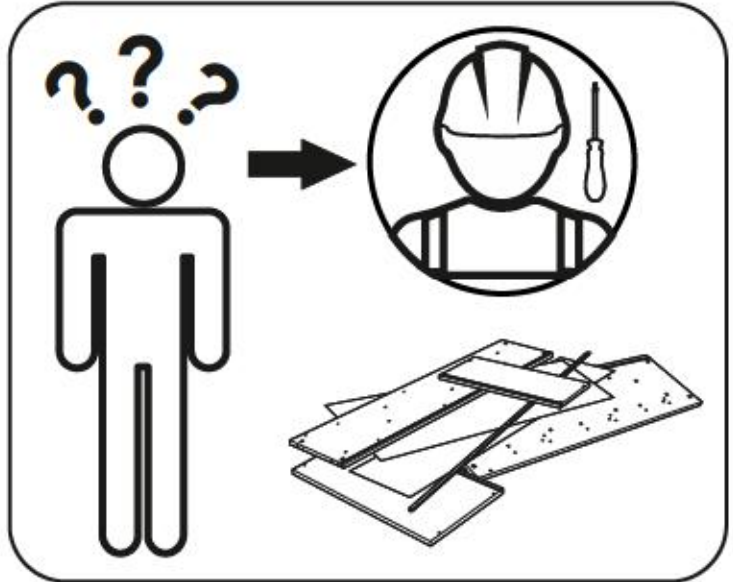
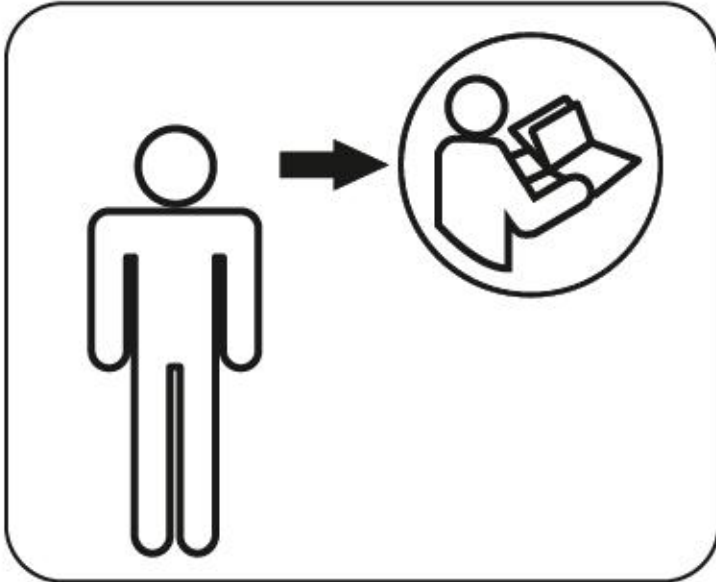
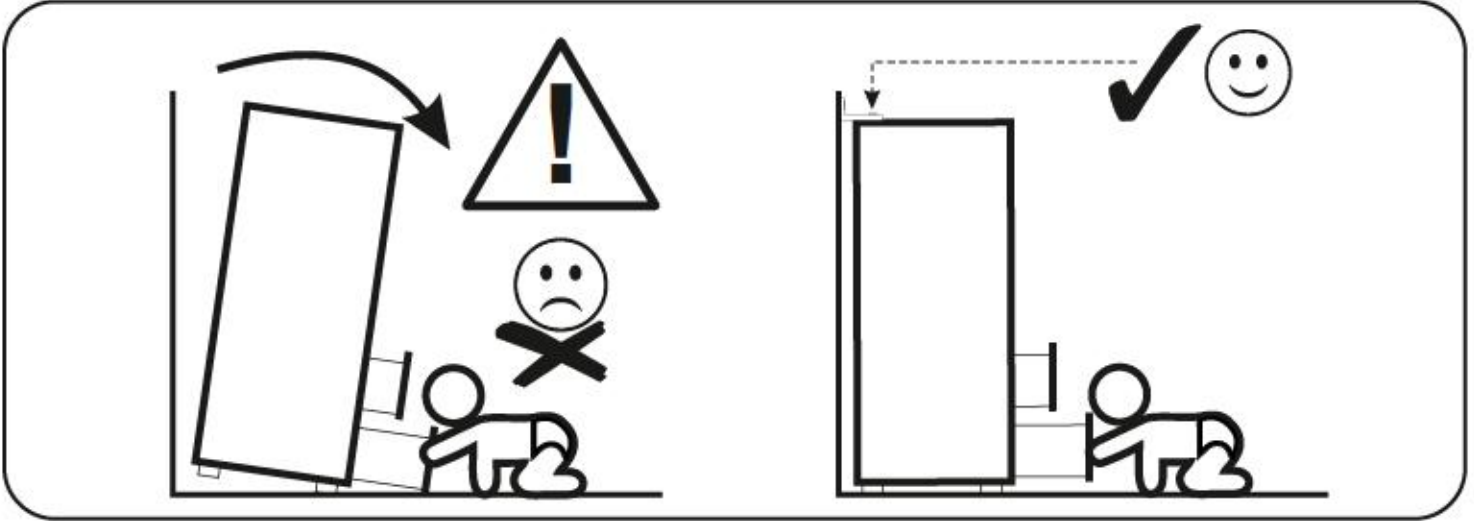
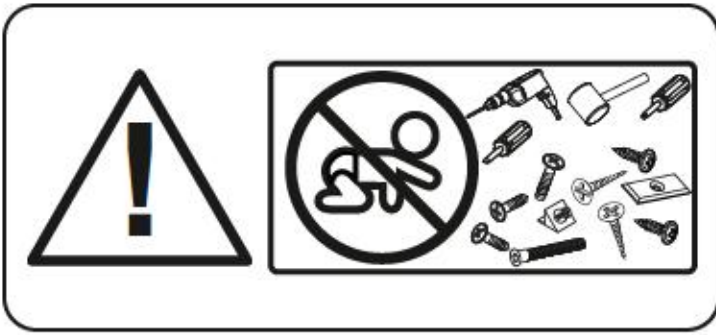



version A



version B

BCxx



BCxx

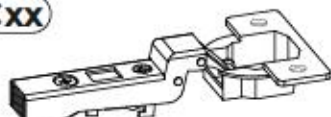

BCxx + BCxx

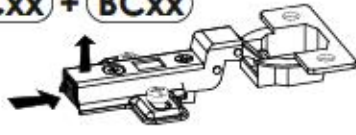

BCxx

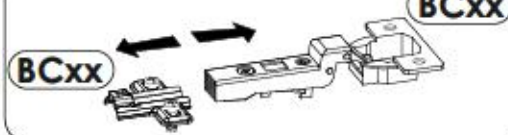

BCxx

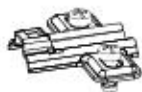

BCxx



BCxx + BCxx



BCxx

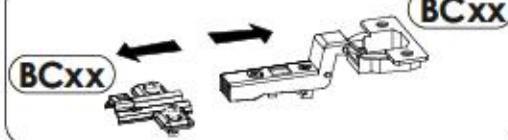

BCxx

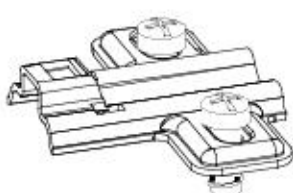

OK

BCxx

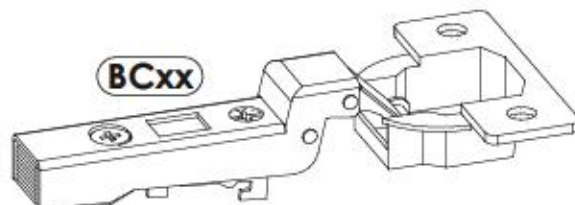

BCxx

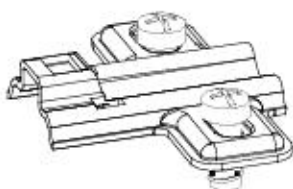





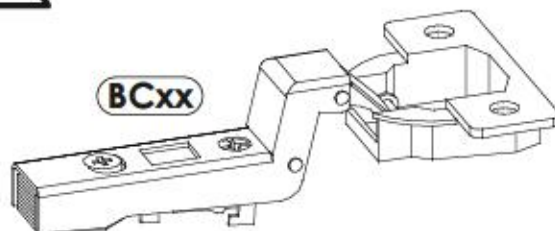



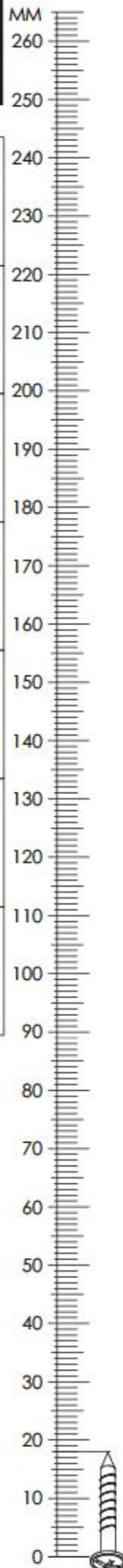











OK

BCxx

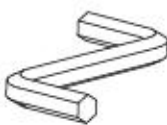

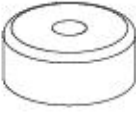
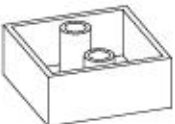
3WSYHU52/3WSEHU52

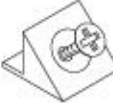
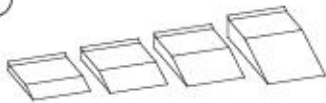

A1	8 x 35 mm 	x24	BC13 + BC14 	x4	BC15 + BC16 	x4		
C2	5 x 13 mm 	x16	D2 	x28	E0	Ø16 	x14	
E1	15 x 12 mm 	x18	F1	6 x 34 mm 	x18	G1	7 x 50 mm 	x6
H1	L - 75 mm 	x4	I2	4 x 16 mm 	x2	I3	3,5 x 22 mm 	x3
I13	4 x 30 mm 	x8	K7	4 x 22 mm 	x8	M		x1
N1	3 x 16 mm 	x35	O1		x3	O6		x4
P0	 Ø5	x6	Q9		x2	R1		x15
R4		x8	Z		x1			

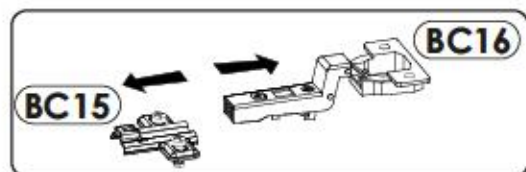
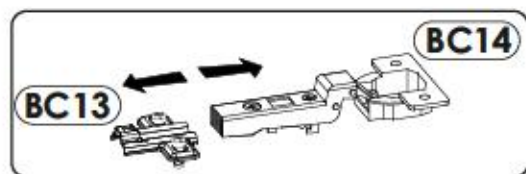

3WSYHU52/3WSEHU52

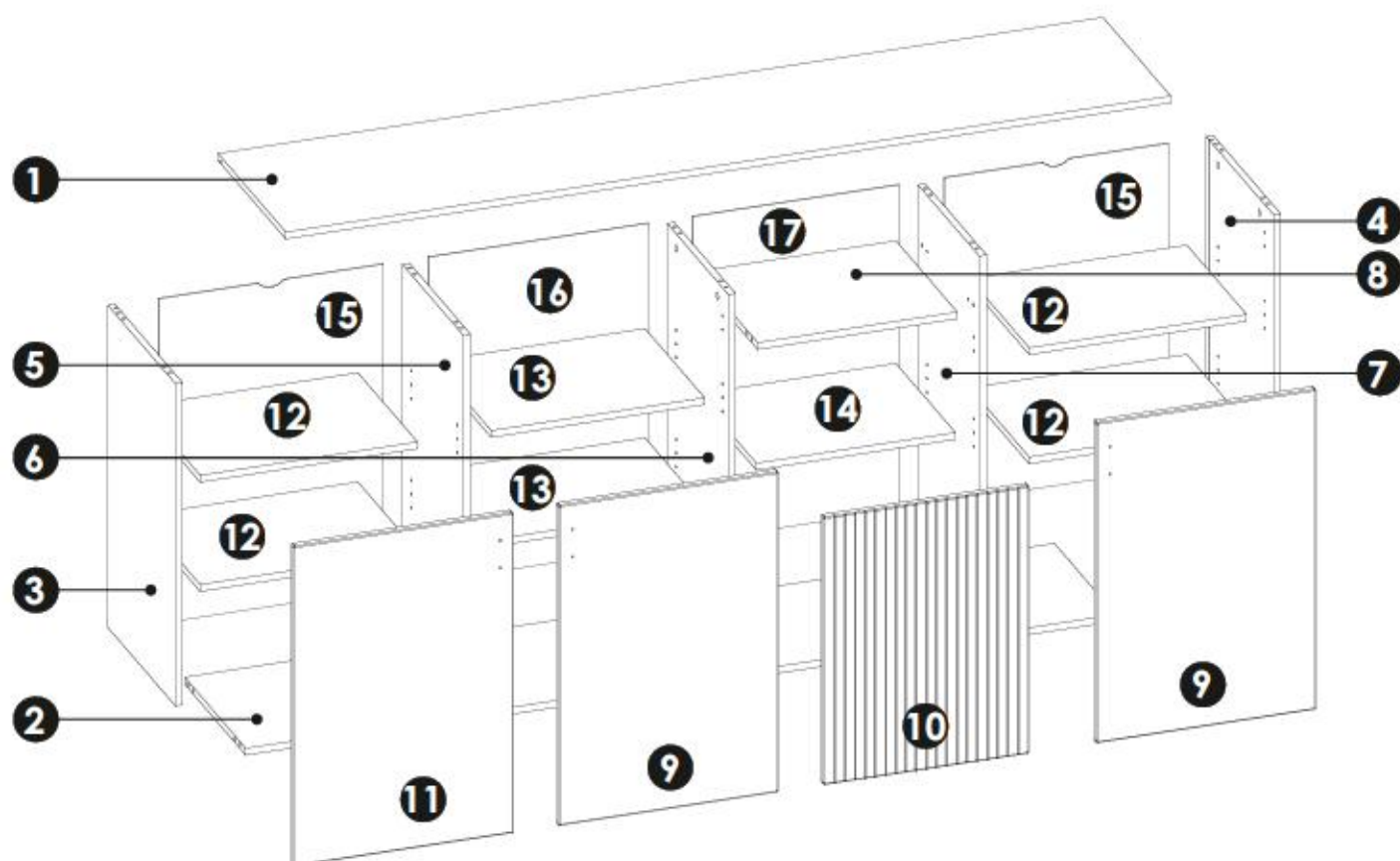
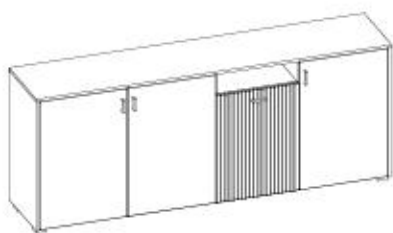

1	2000	420	16	x1	3/3
2	1966	380	16	x1	3/3
3	755	419	16	x1	3/3
4	755	419	16	x1	3/3
5	739	380	16	x1	1/3
6	739	380	16	x1	1/3
7	739	380	16	x1	1/3
8	451	380	16	x1	1/3
9	750	496	16	x2	2/3
10	627	463	16	x1	2/3
11	750	496	16	x1	2/3
12	491	370	16	x4	1/3
13	482	370	16	x2	3/3
14	450	370	16	x1	1/3
15	761	506	3	x2	2/3
16	761	497	3	x1	2/3
17	761	465	3	x1	2/3

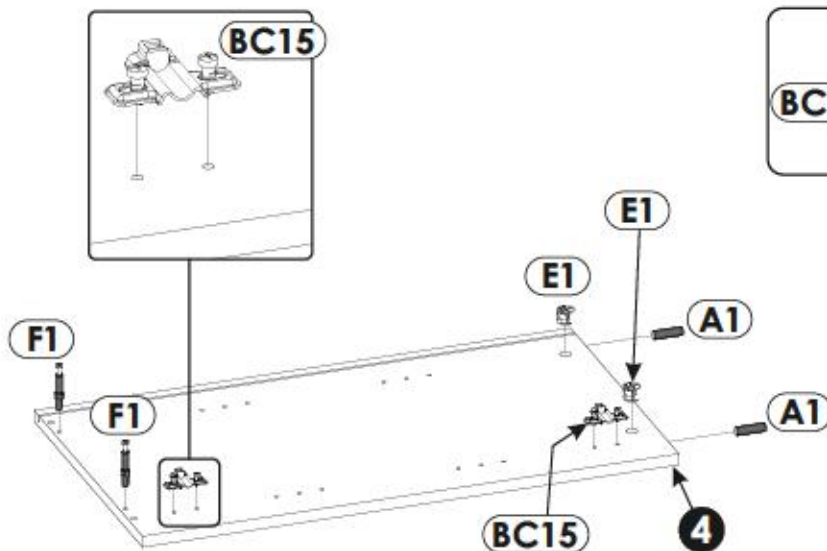
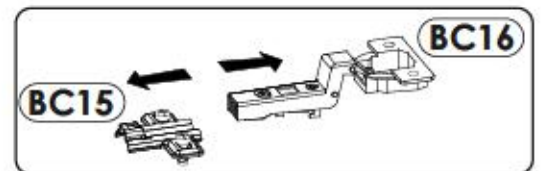
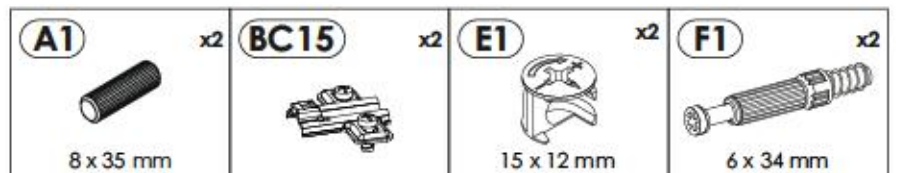
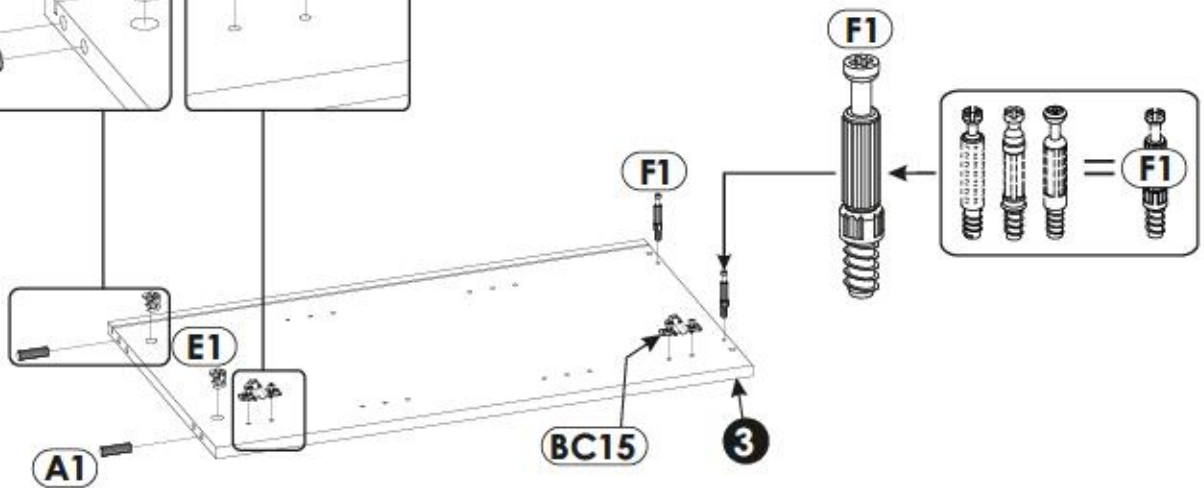
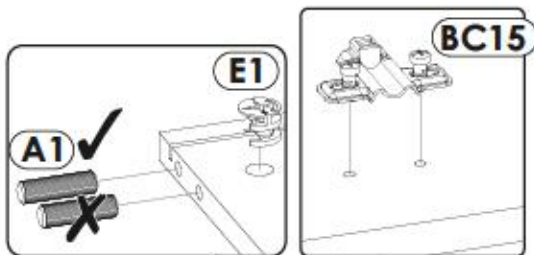
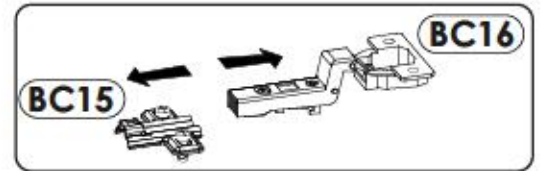
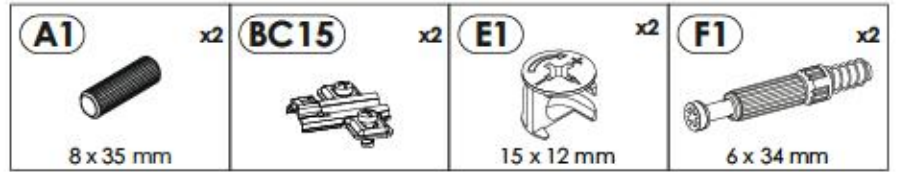
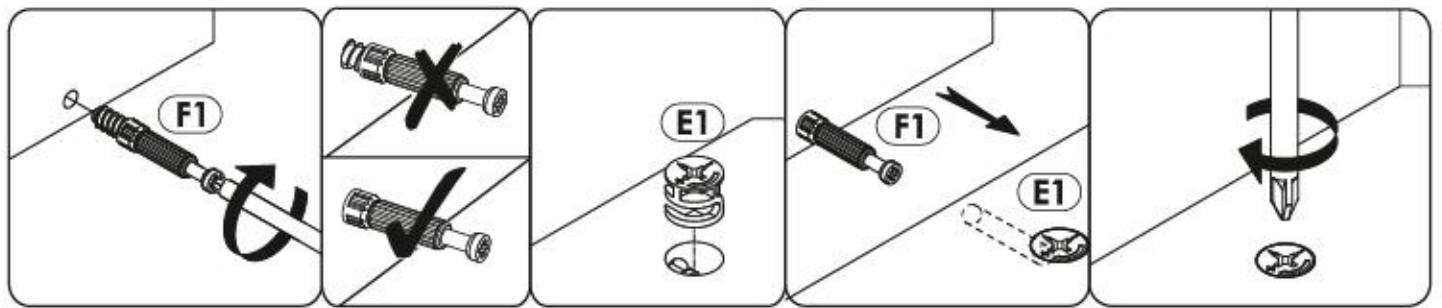

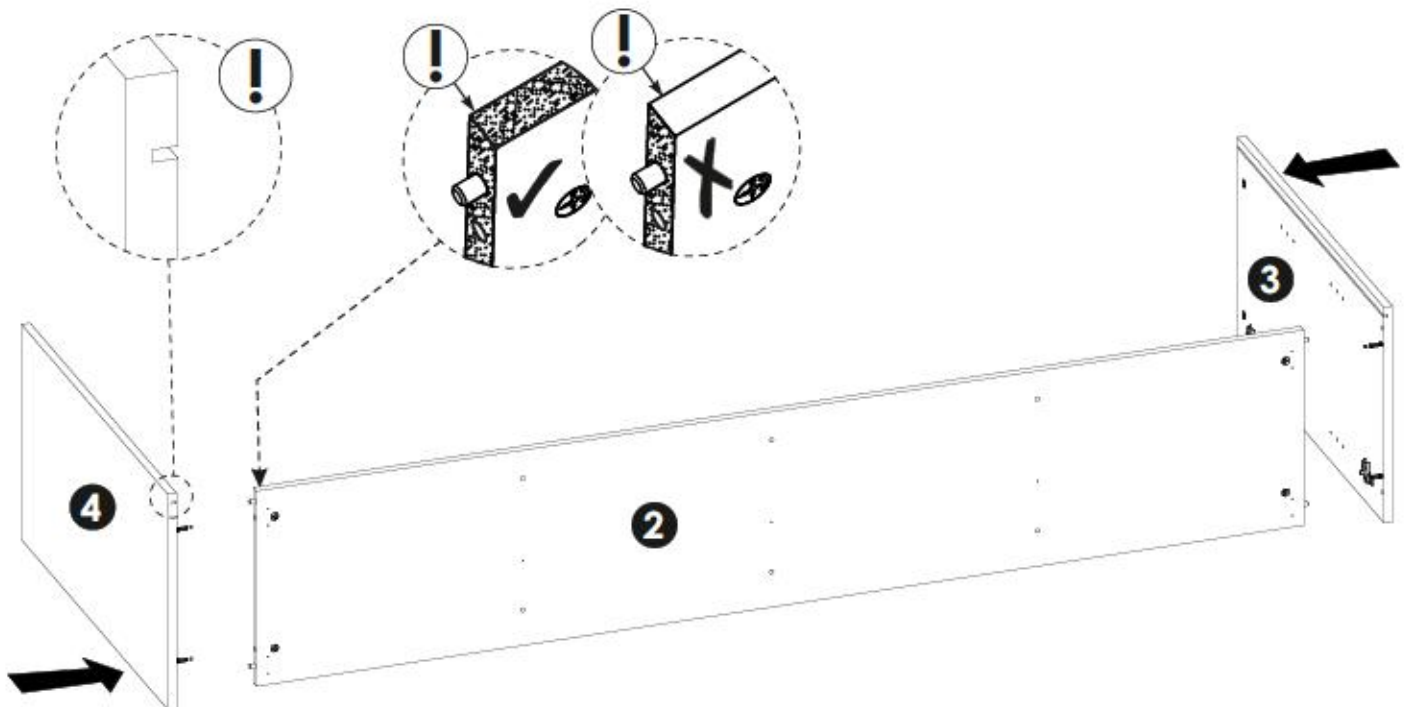
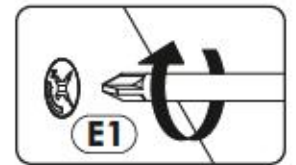
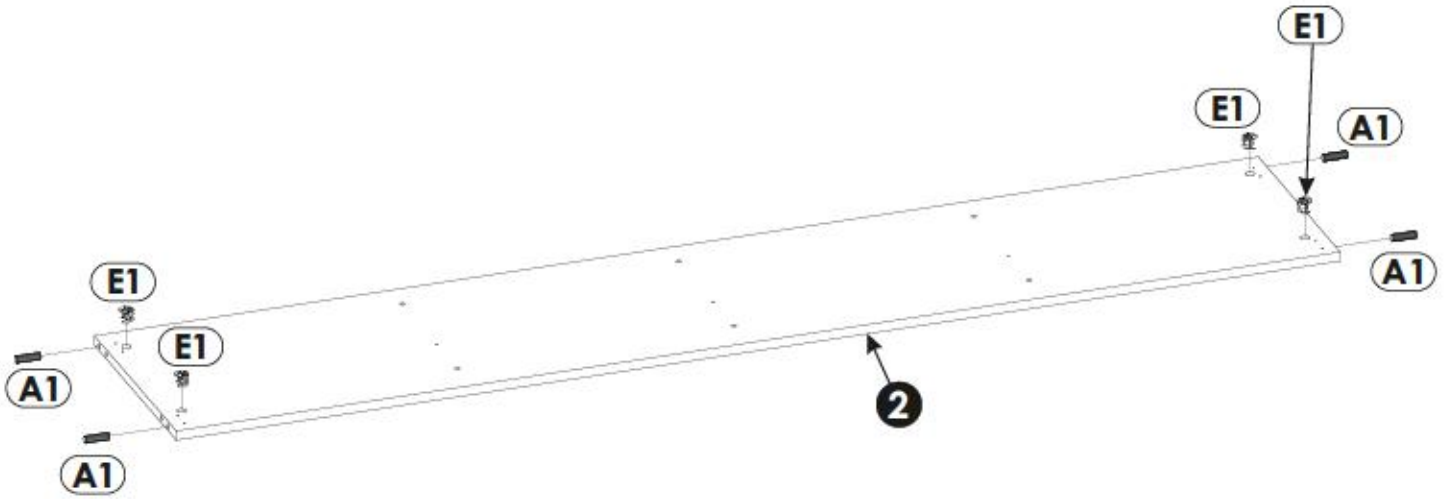
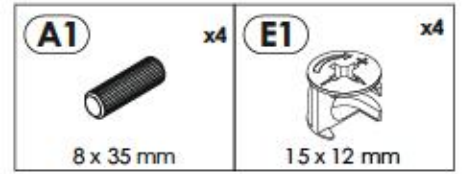

5 ▶

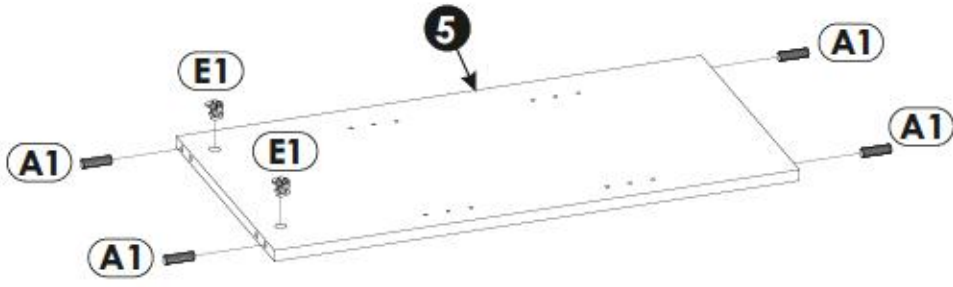
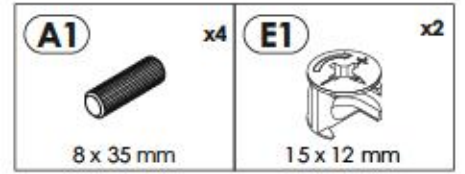

6 ▶

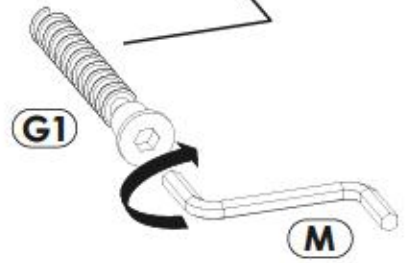
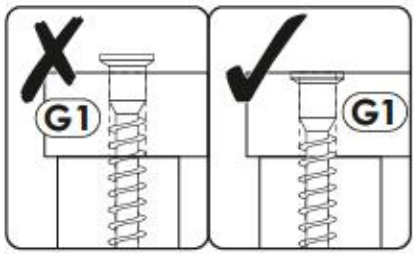
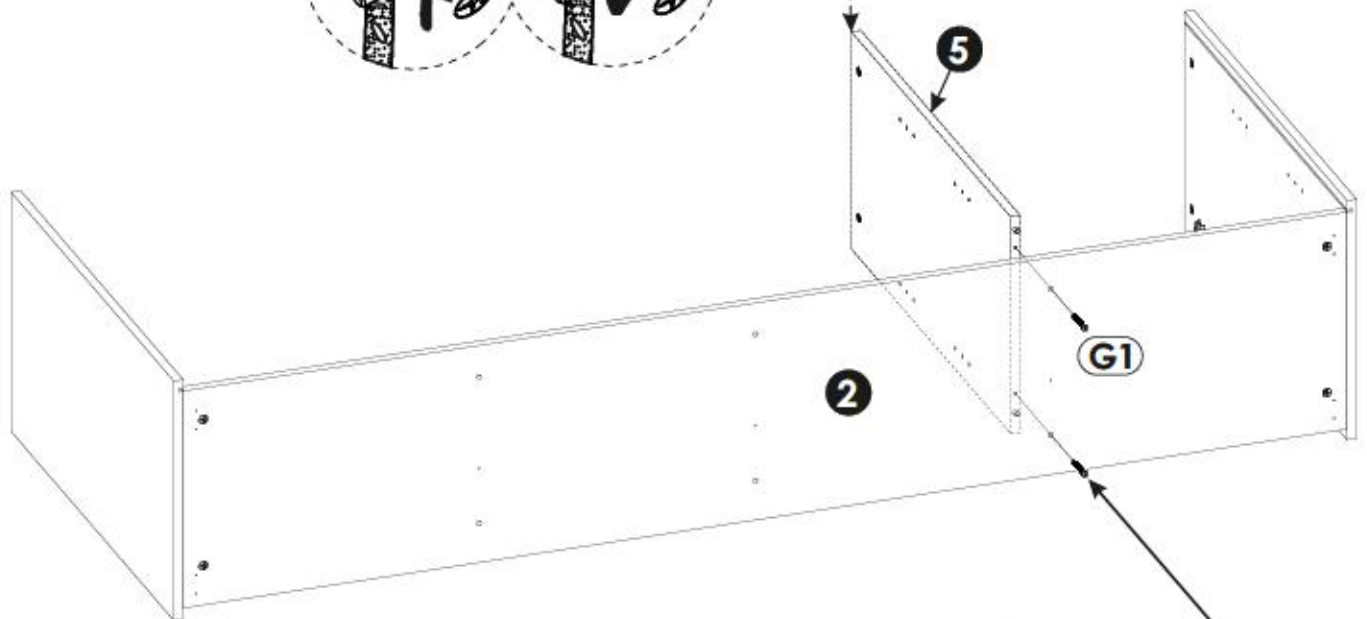
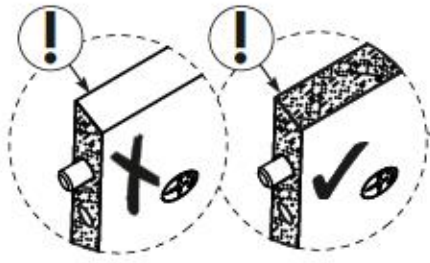
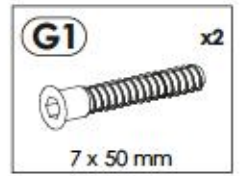
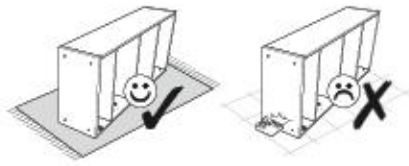

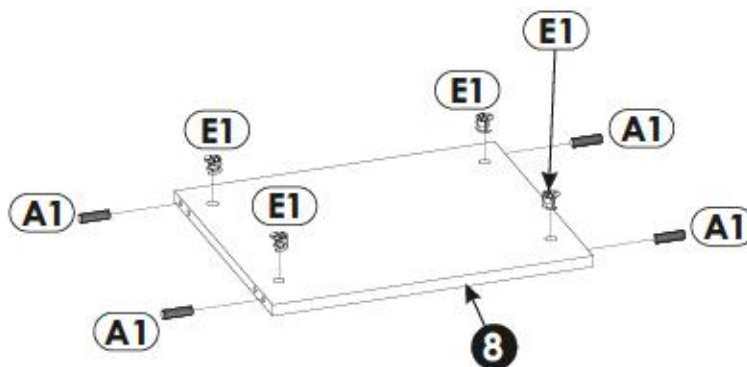
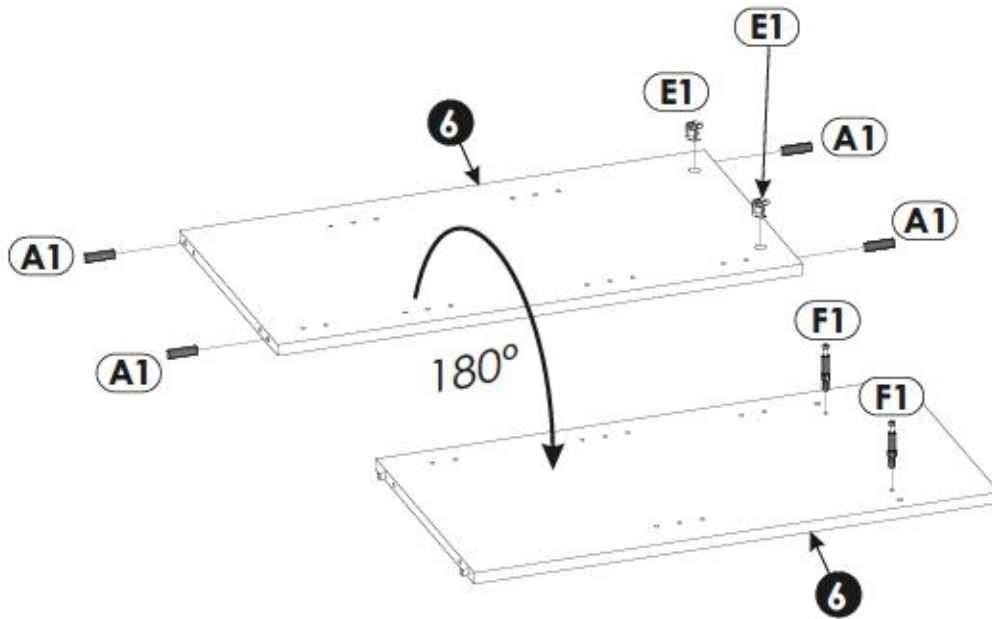
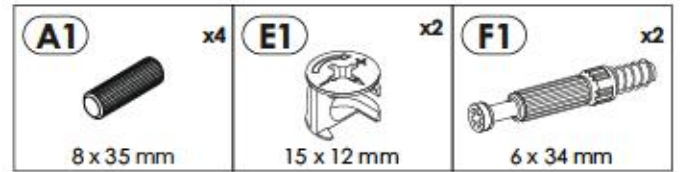

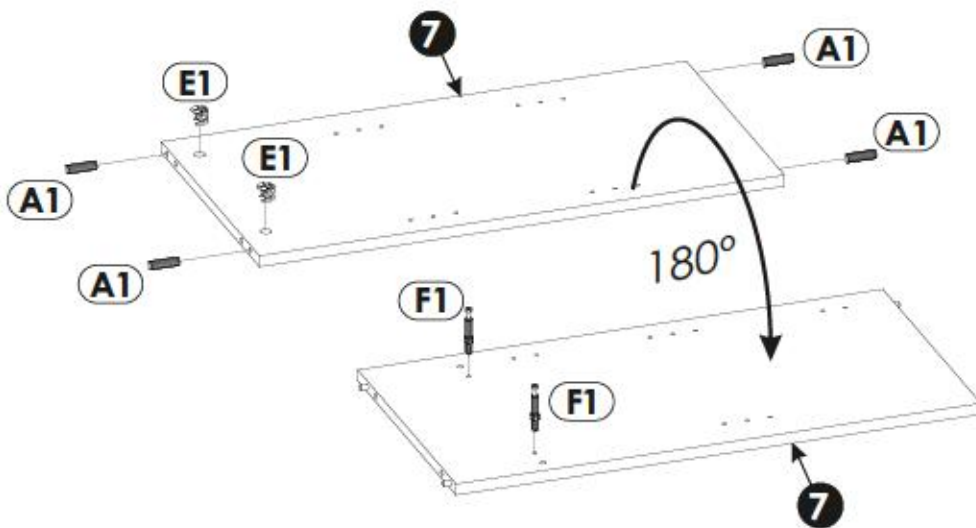
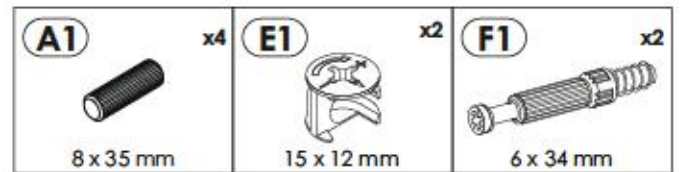
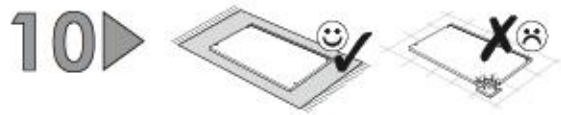
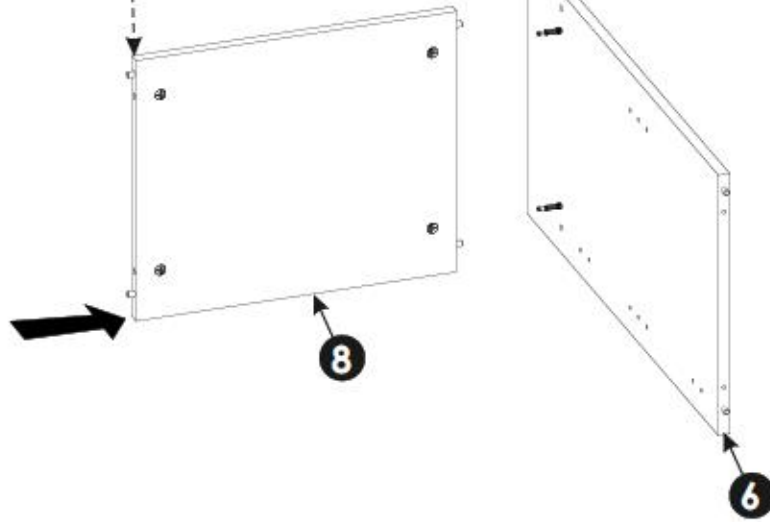
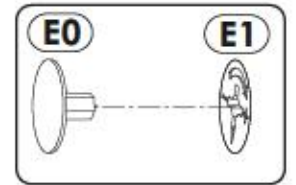
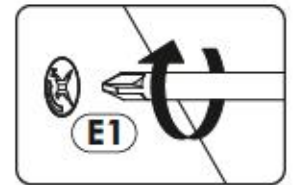
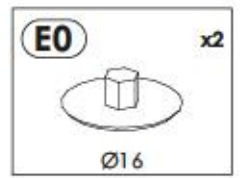
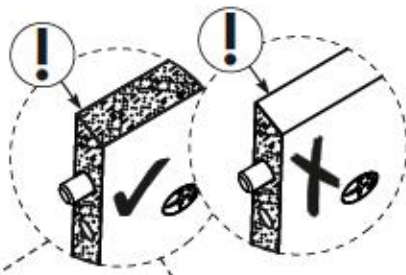

11 ▶

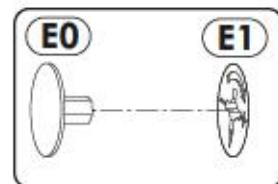
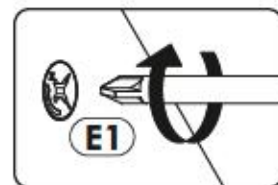
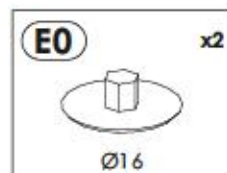
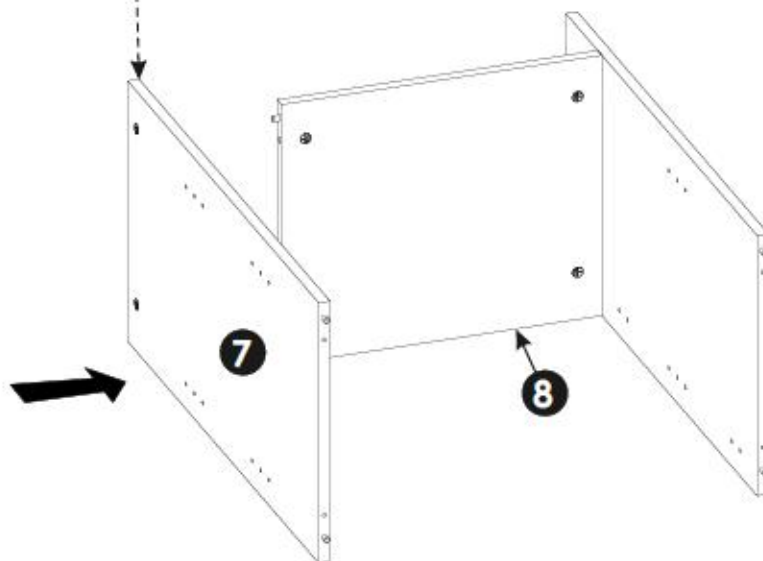
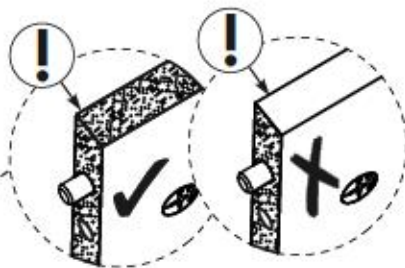
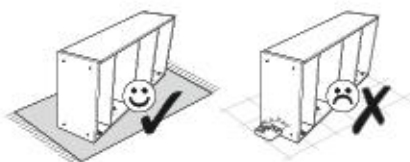

12 ▶

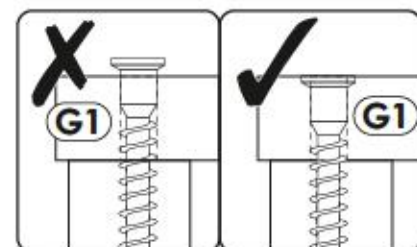
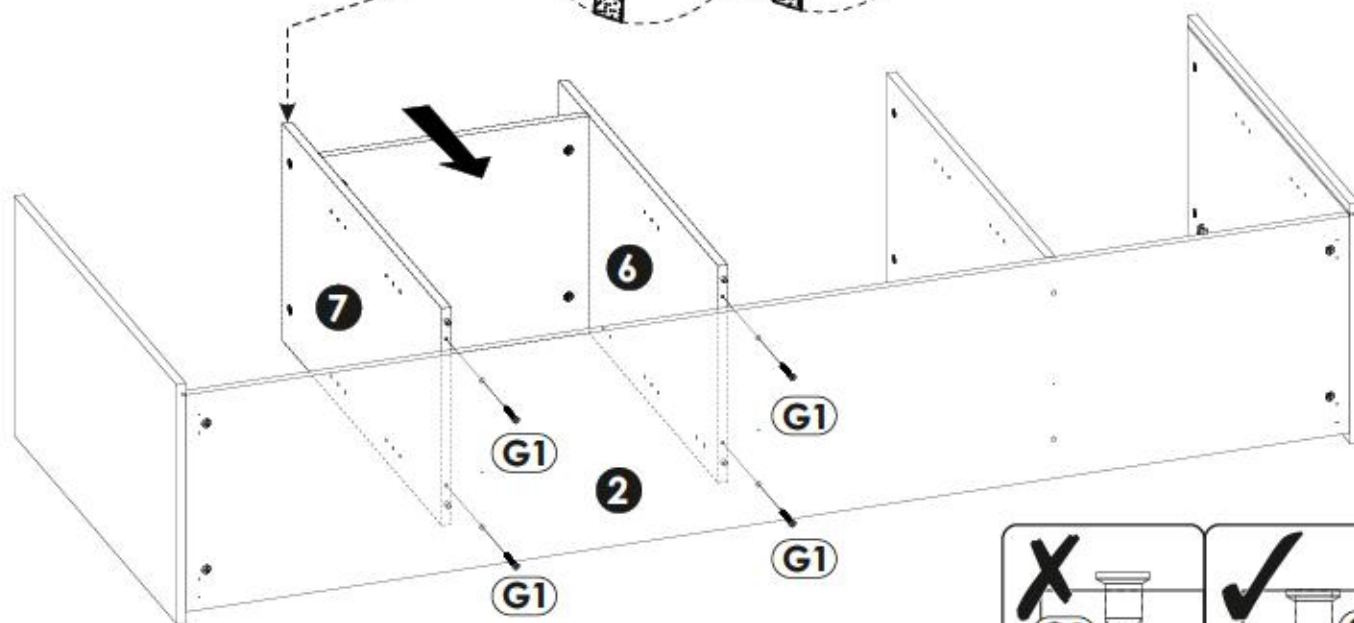
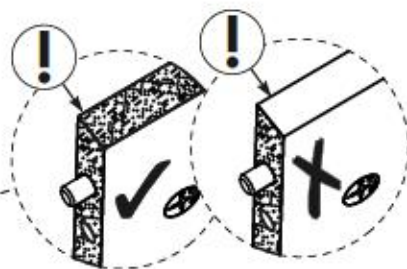
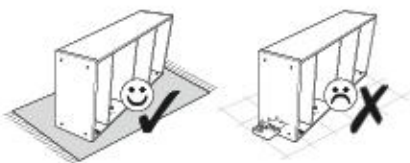

13▶

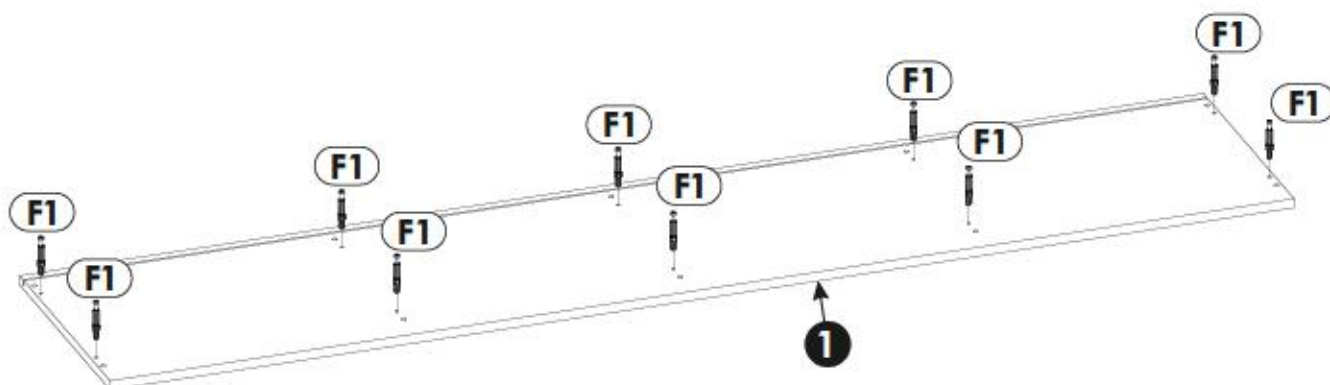
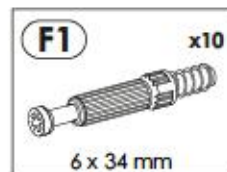

14▶

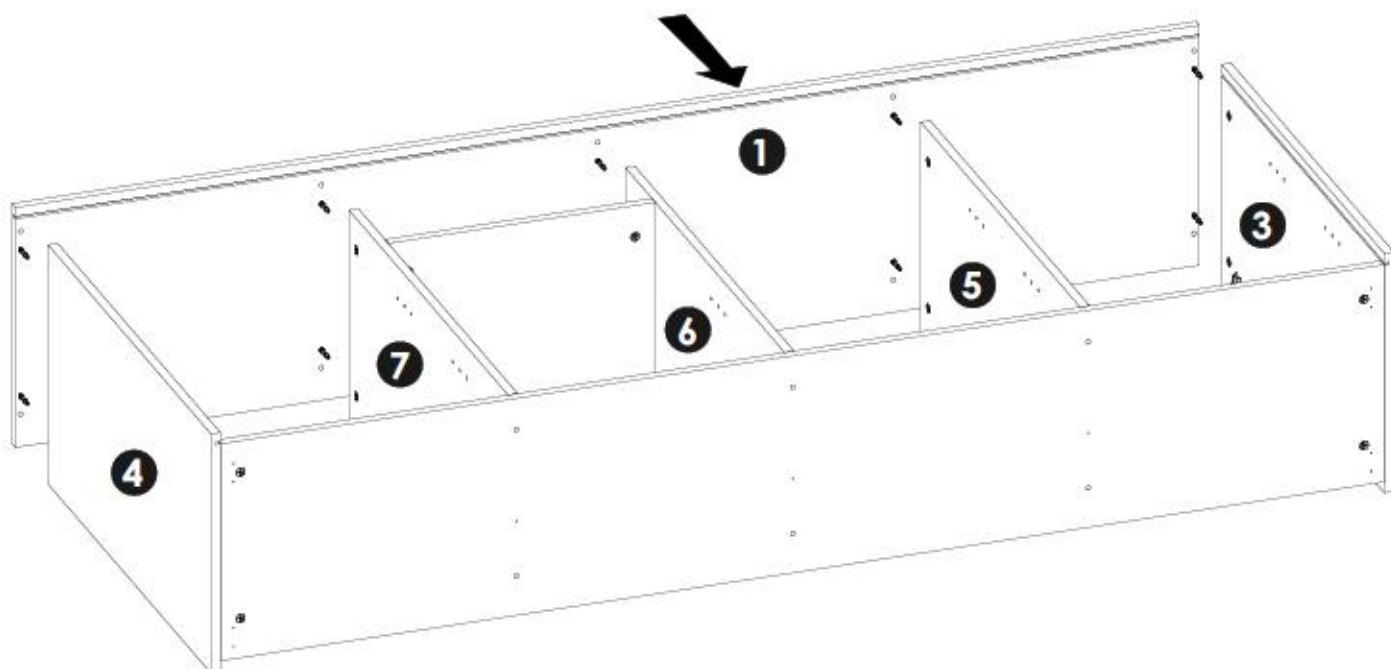
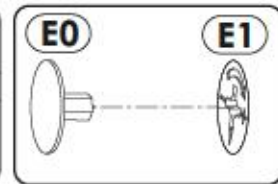
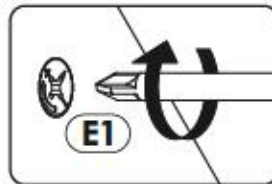
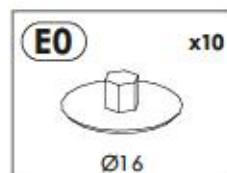
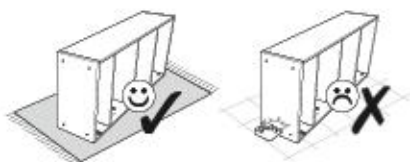

15 ▶

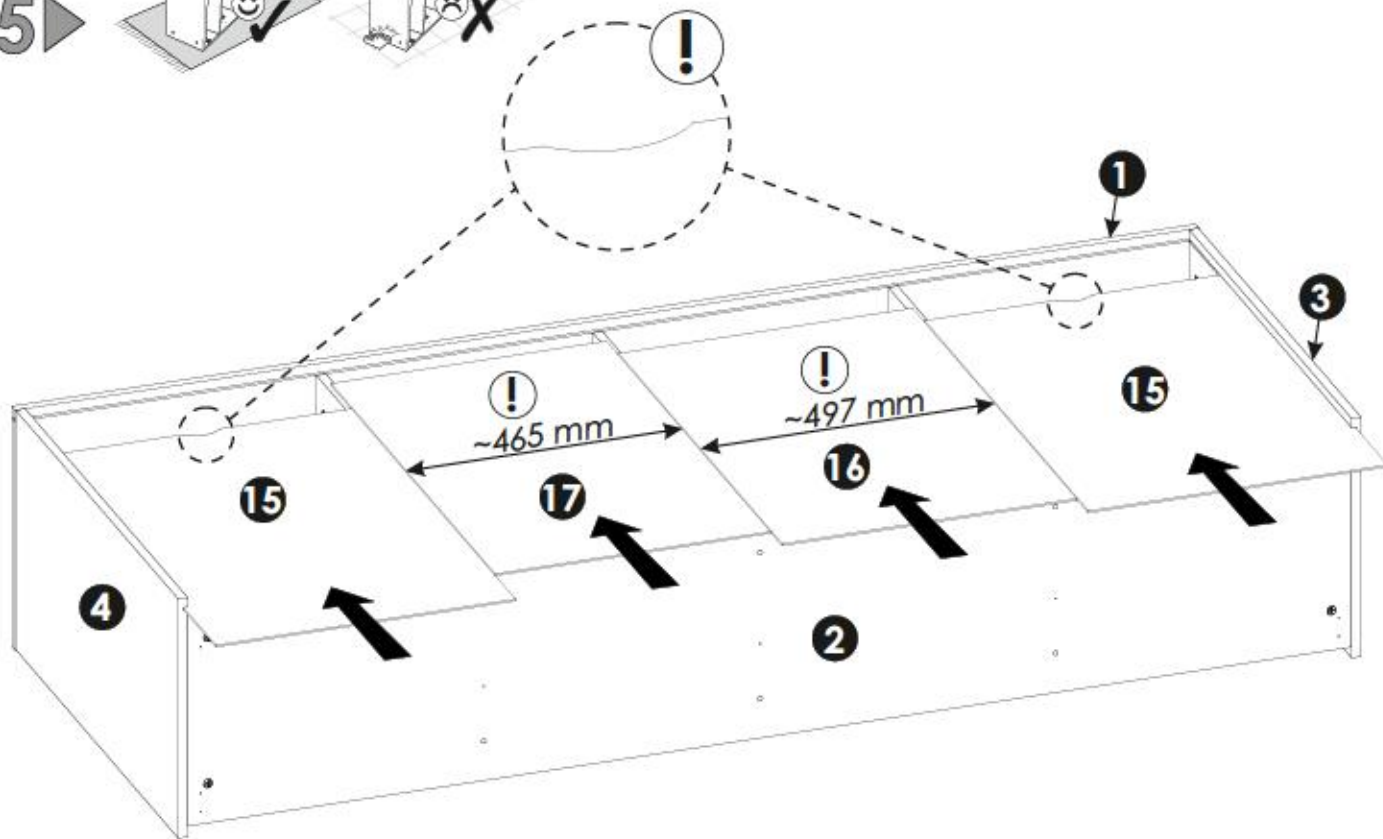
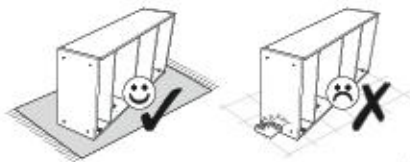

16 ▶

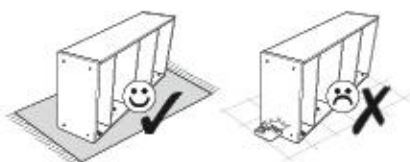

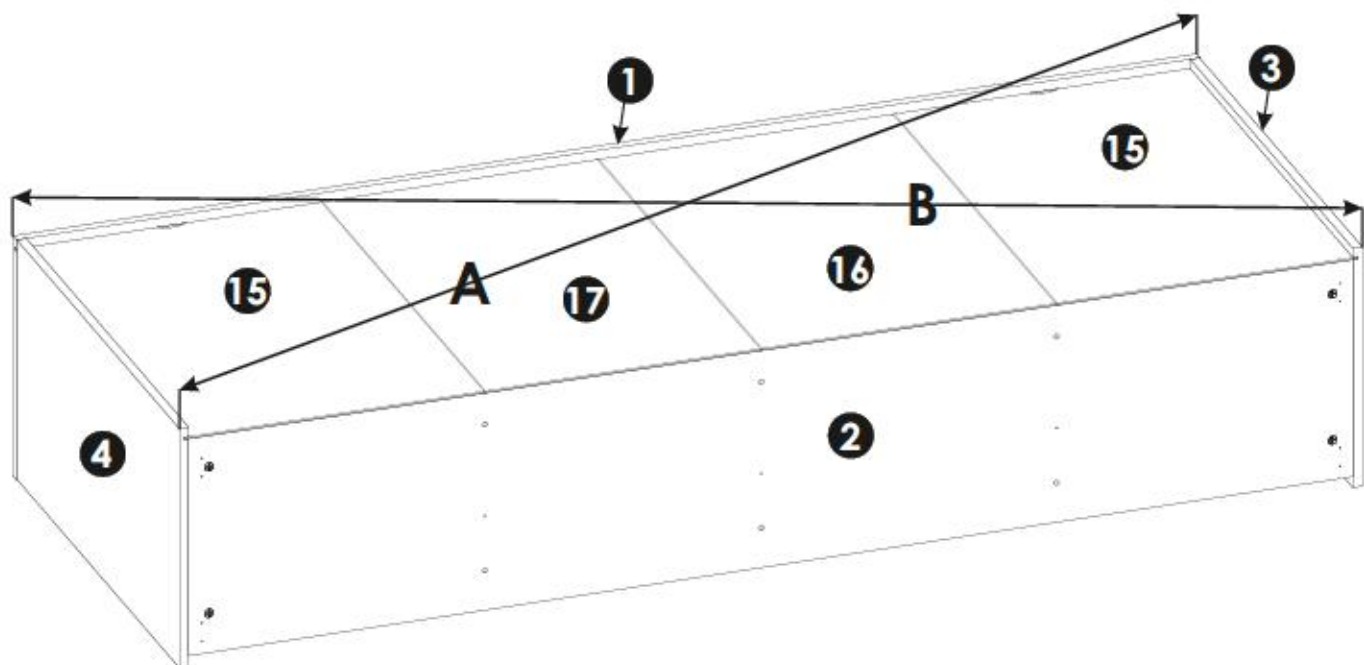
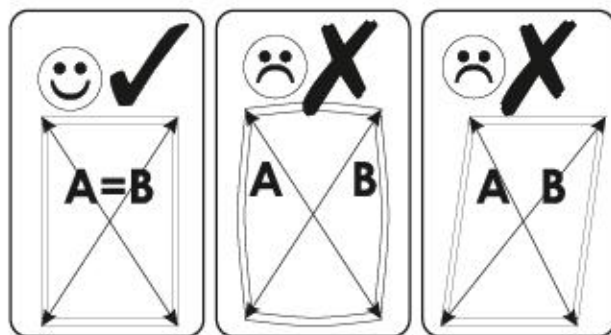

A=B

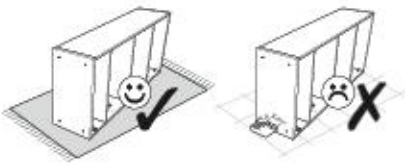

17▶





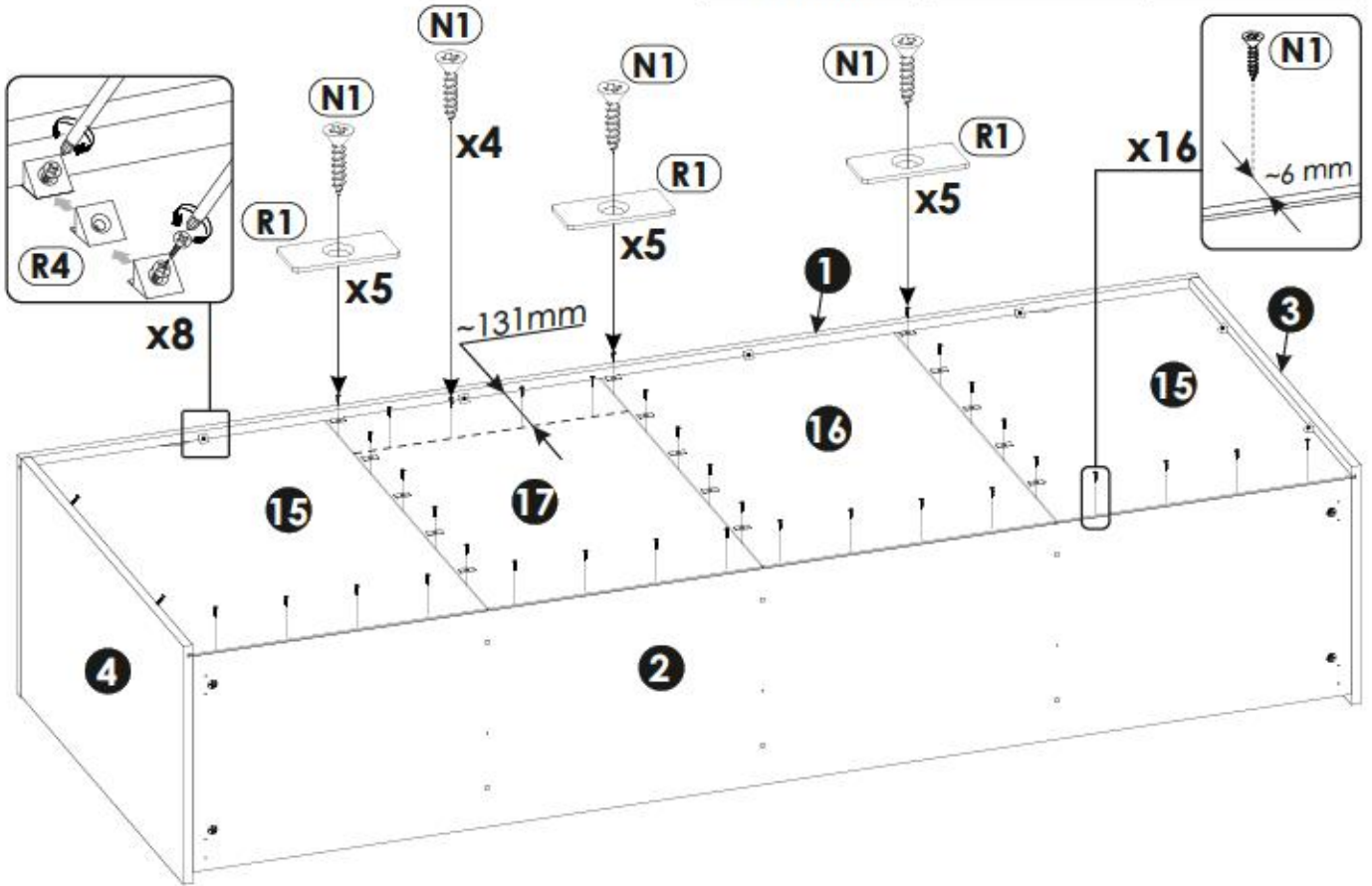

N1	x35	R1	x15	R4	x8
					
3 x 16 mm					

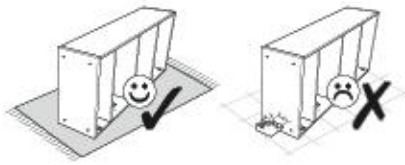

18▶



I3	x3	I13	x8	O1	x3	O6	x4
							
3,5 x 22 mm		4 x 30 mm					

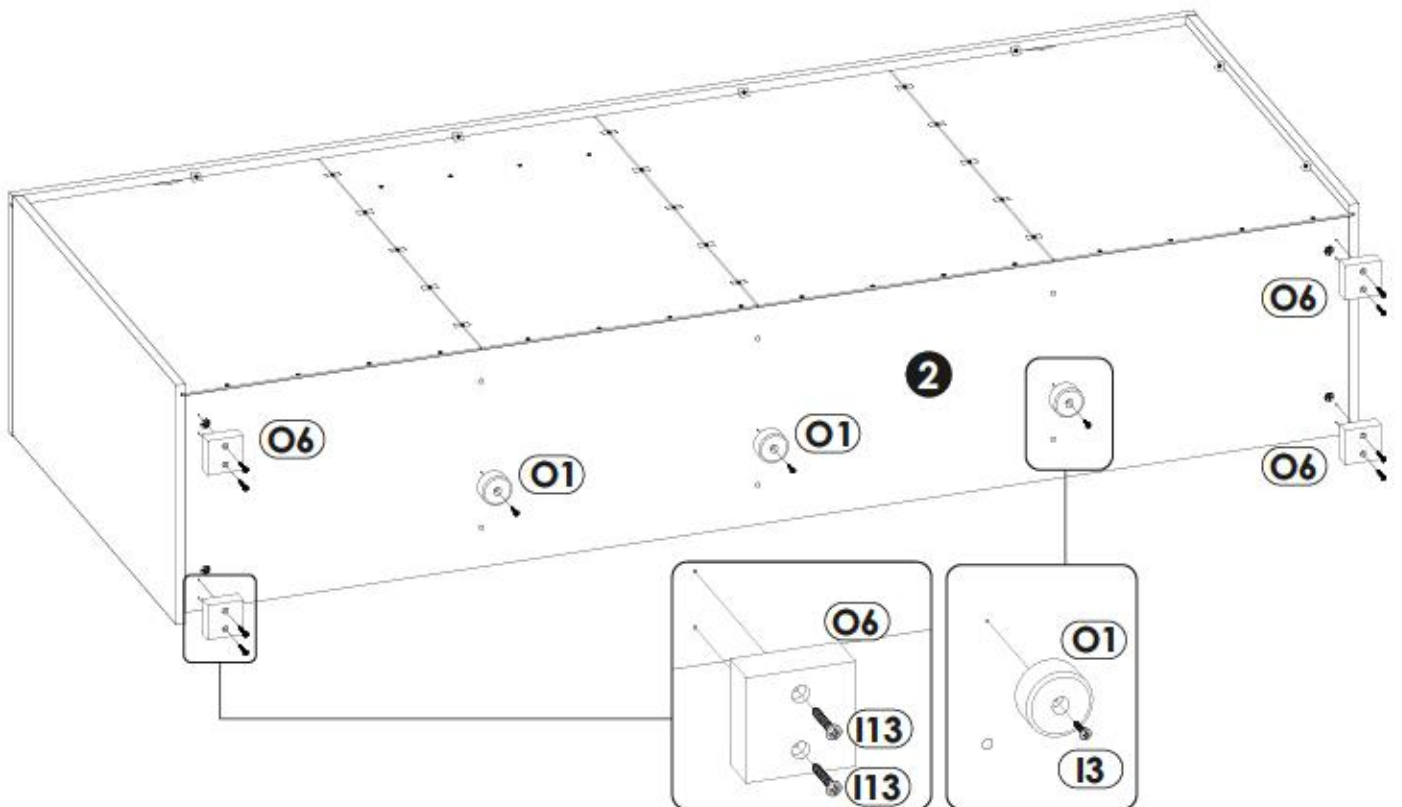

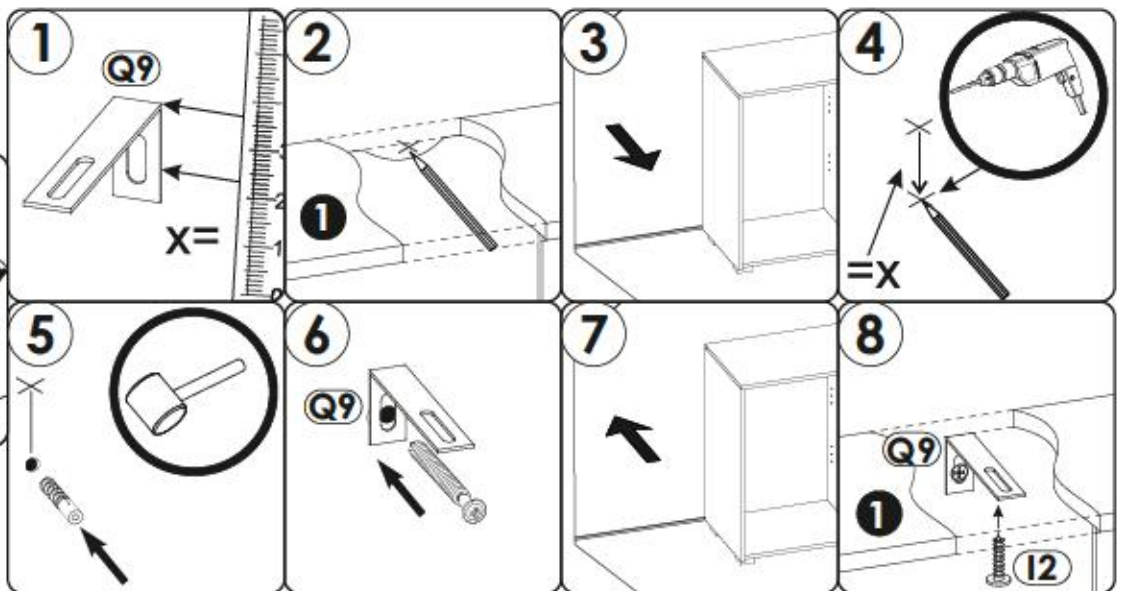
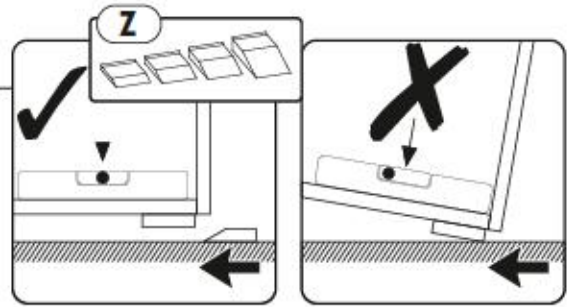
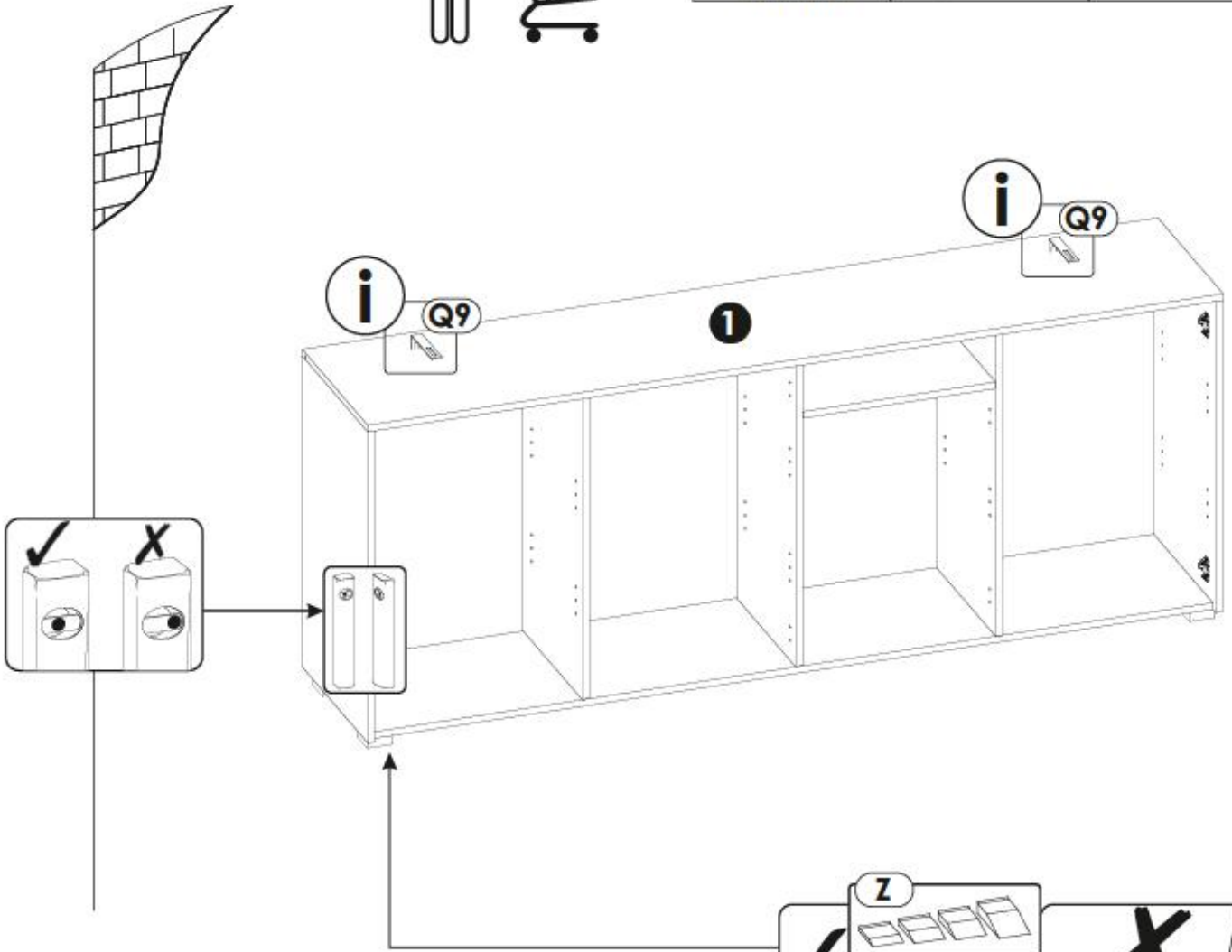
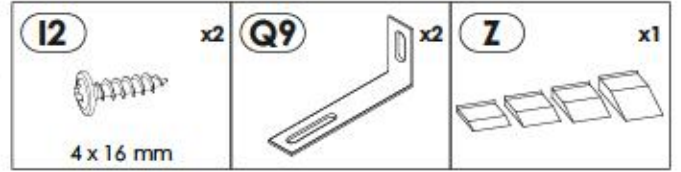

20 ▶

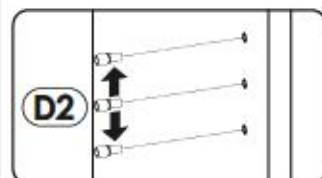
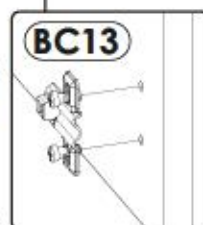
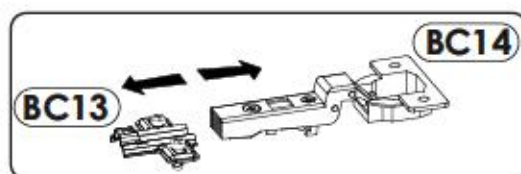
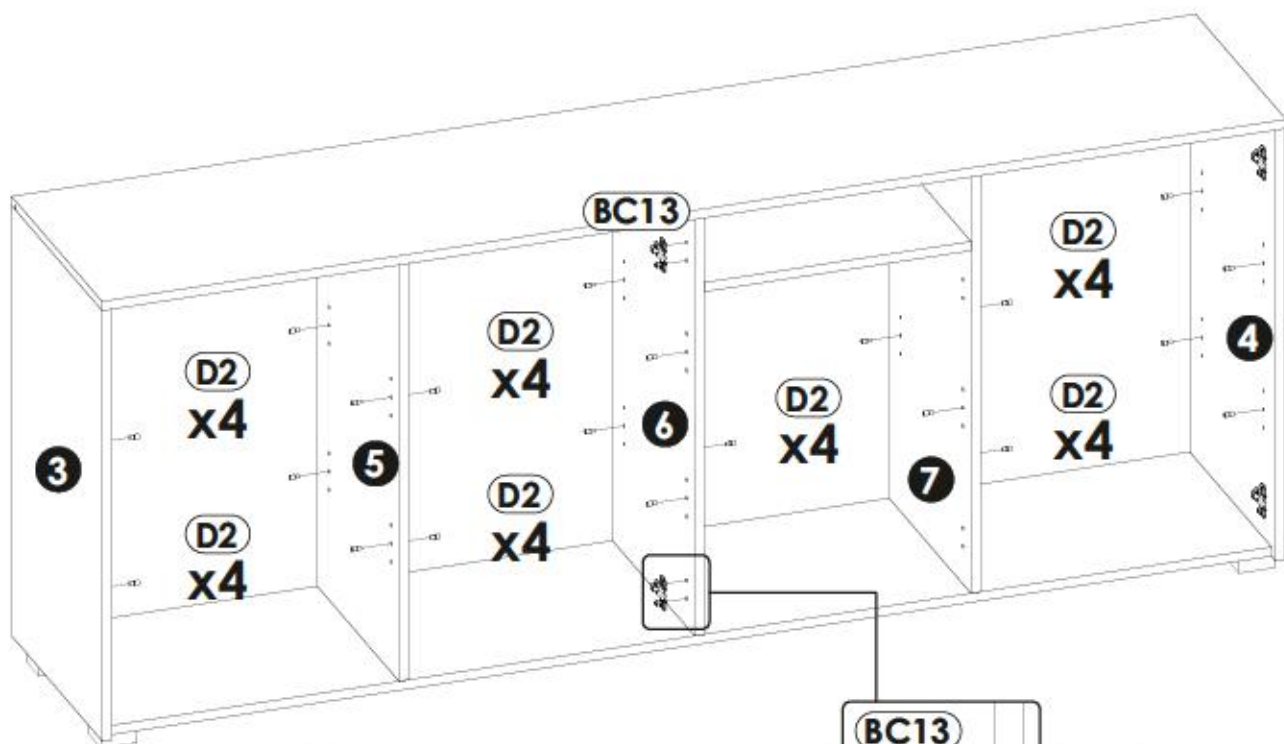
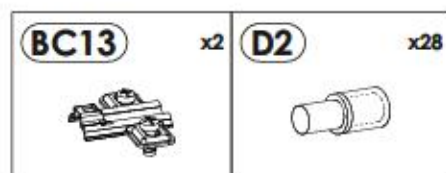

21 ▶

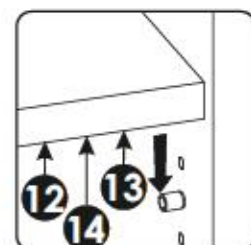
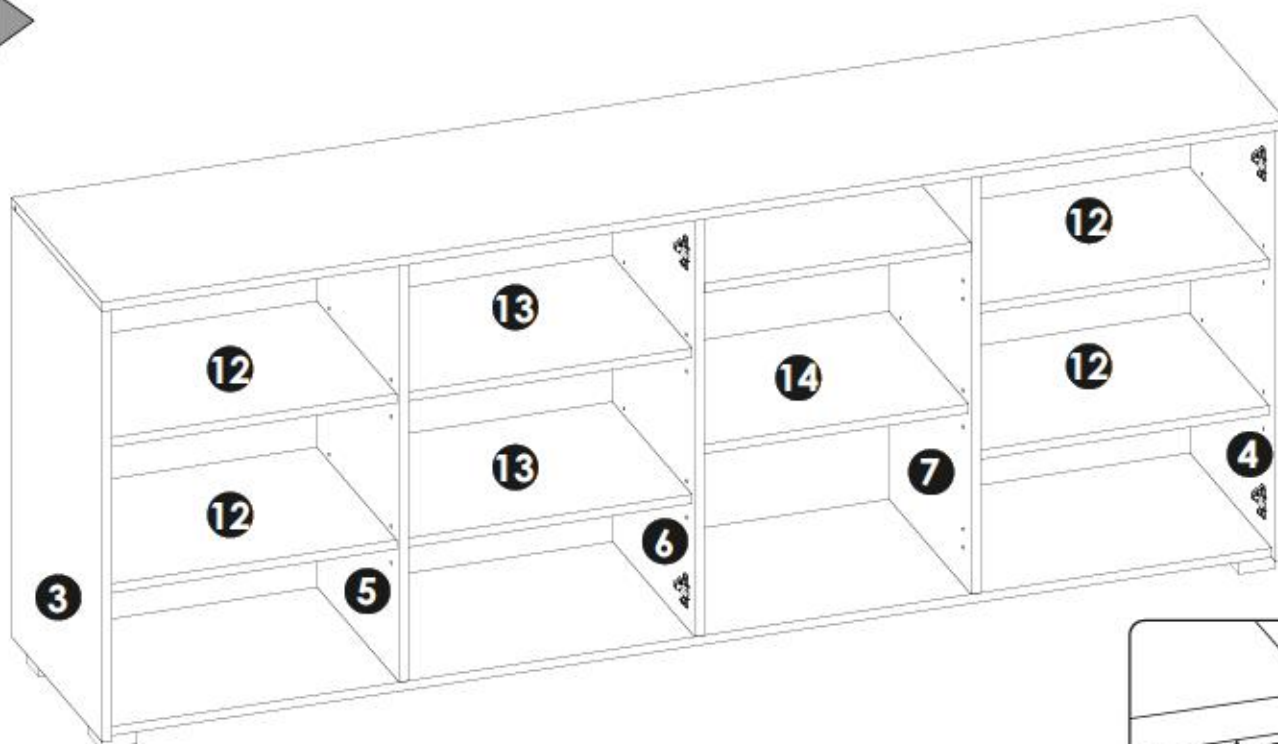

22▶

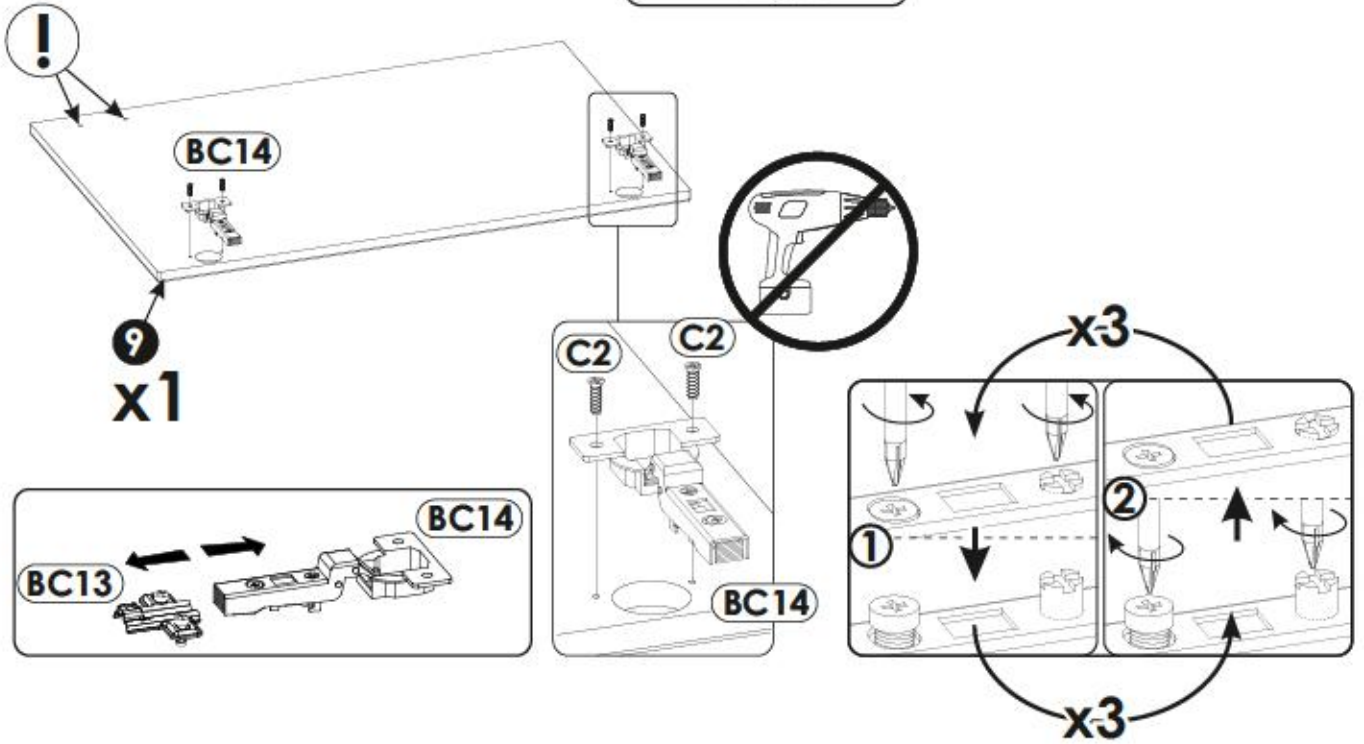
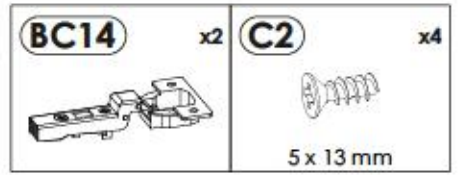

23▶

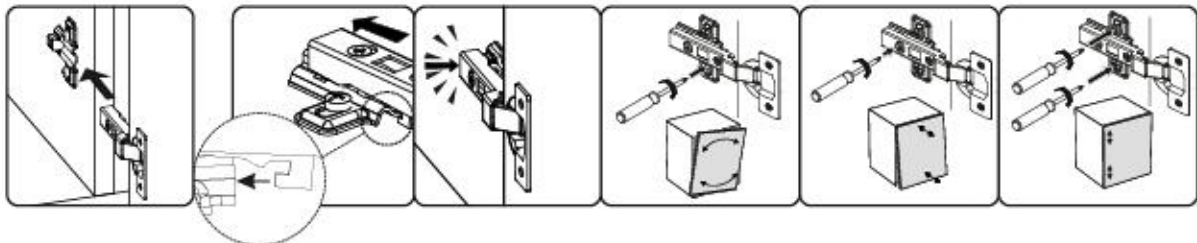
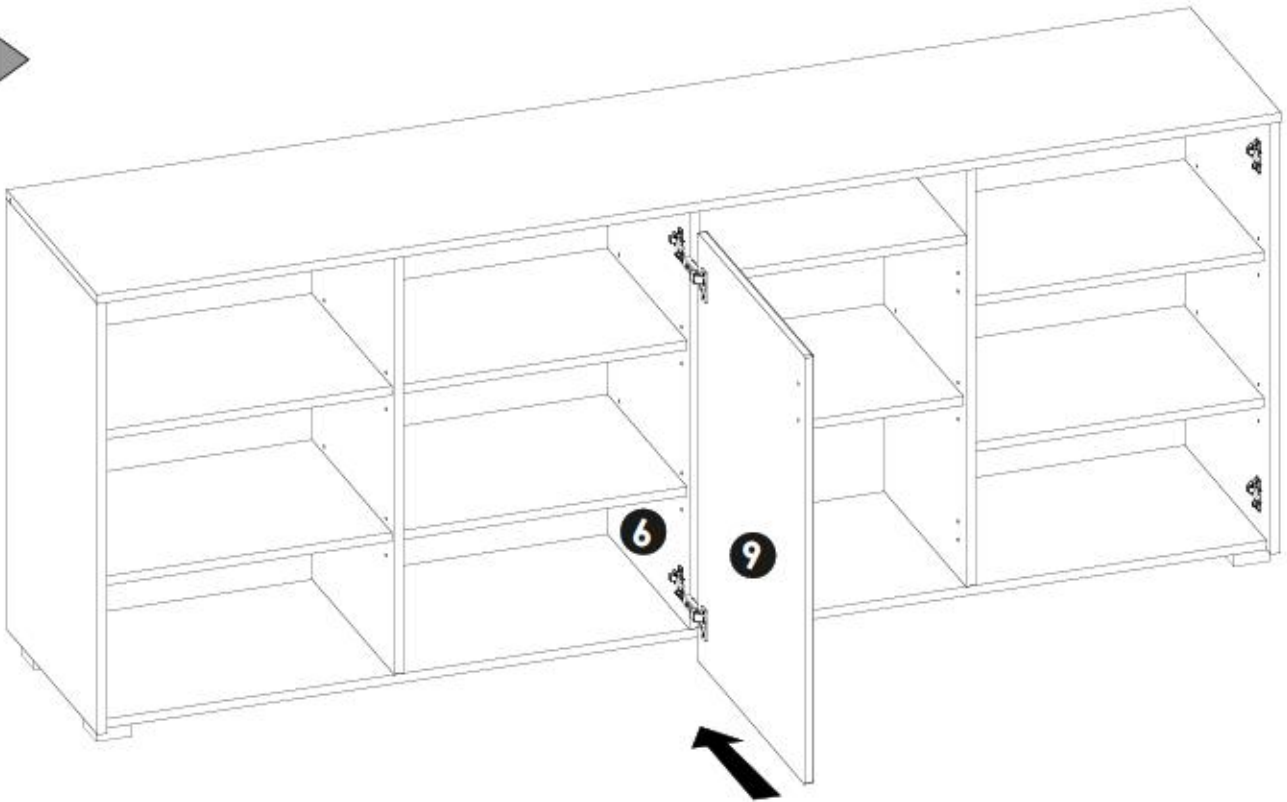

24▶

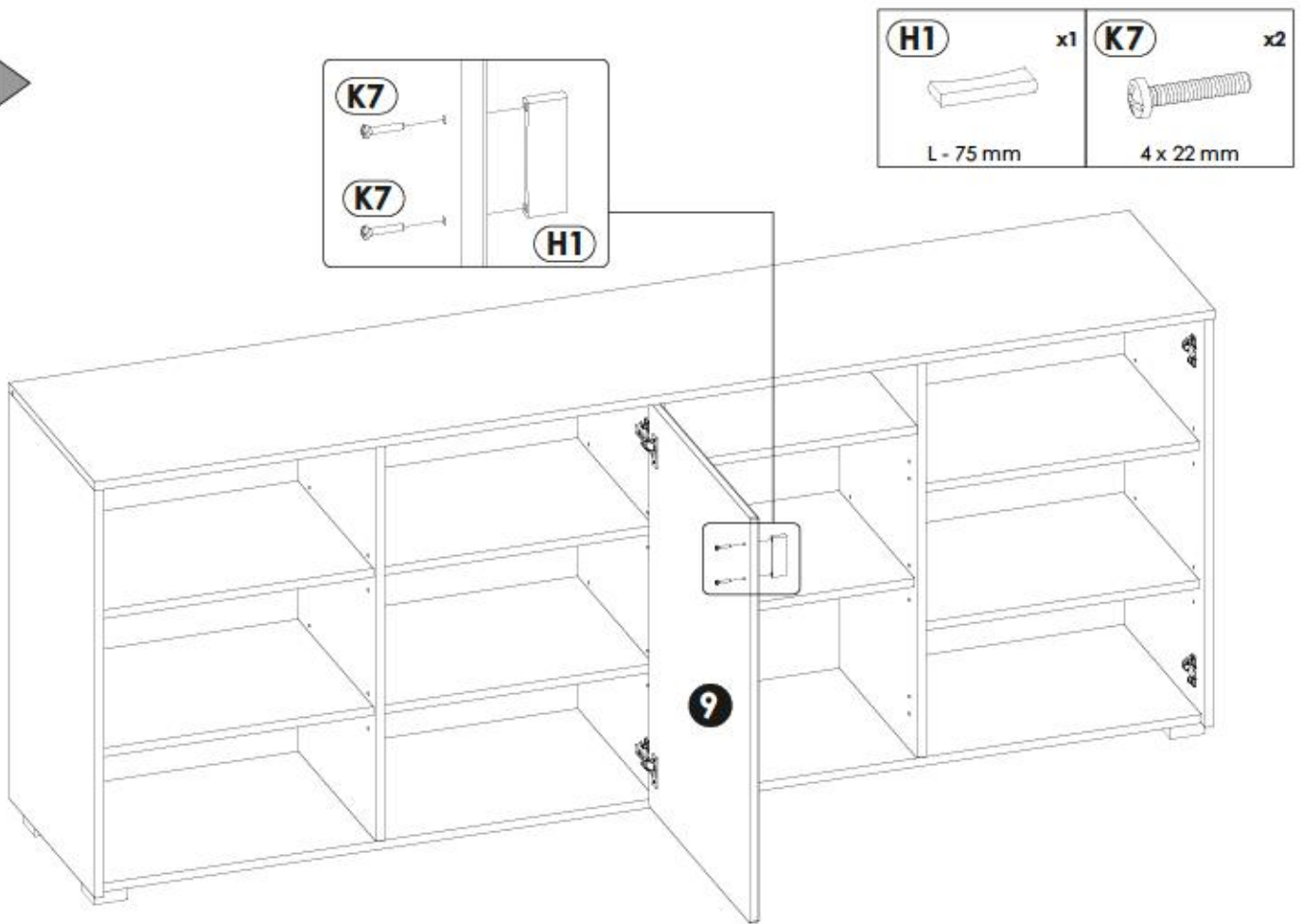

25▶

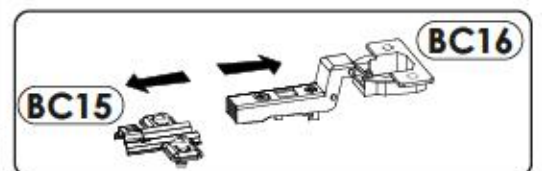
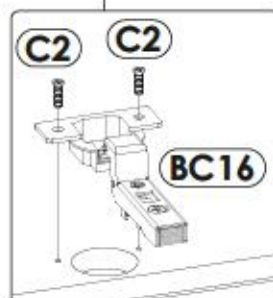
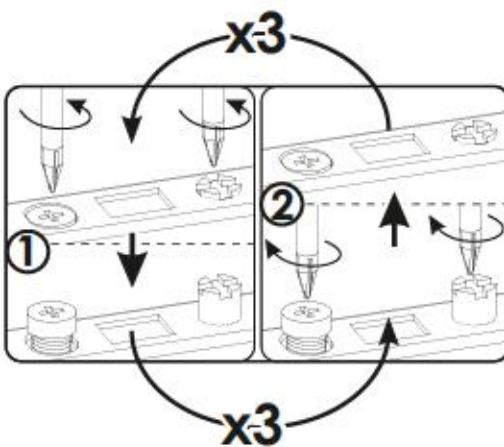
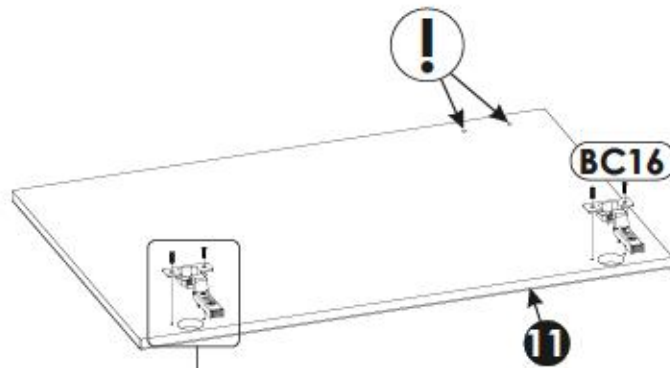
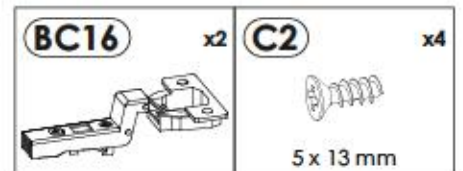

26▶

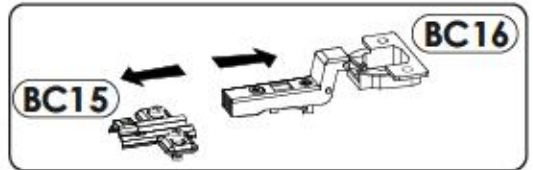
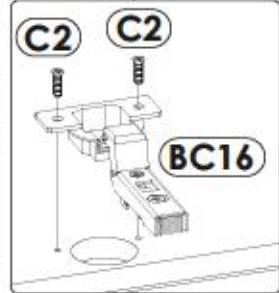
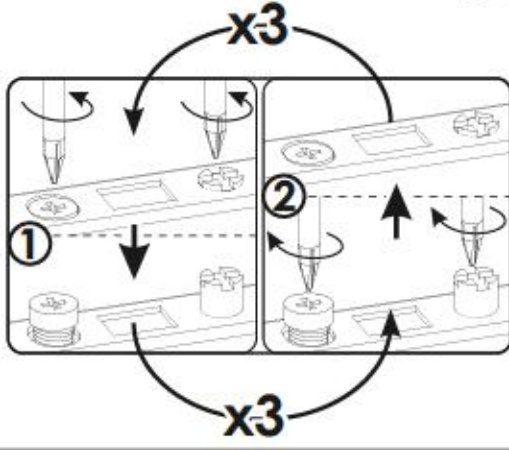
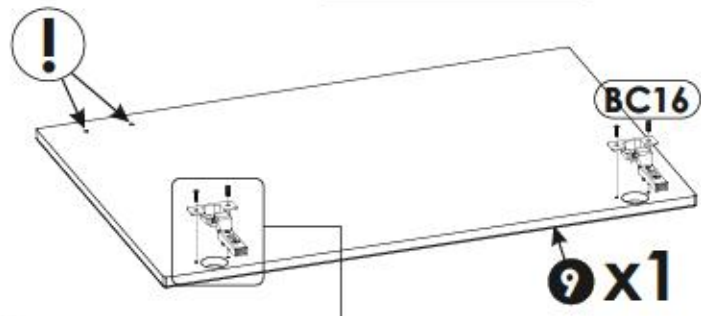
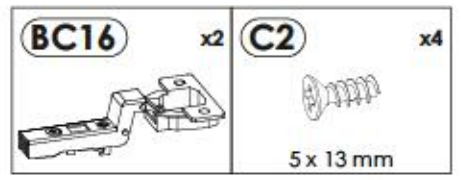

27▶

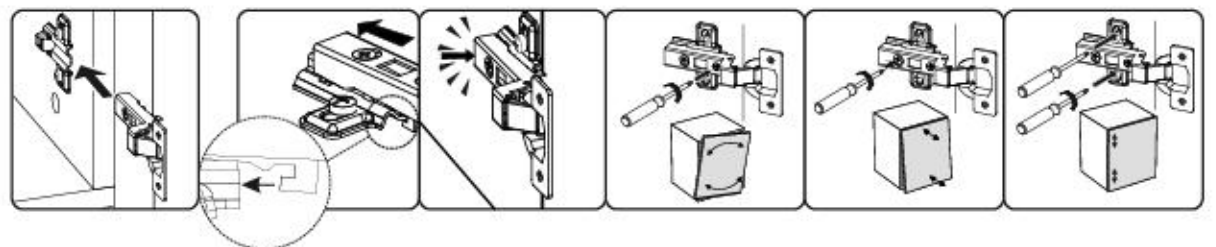
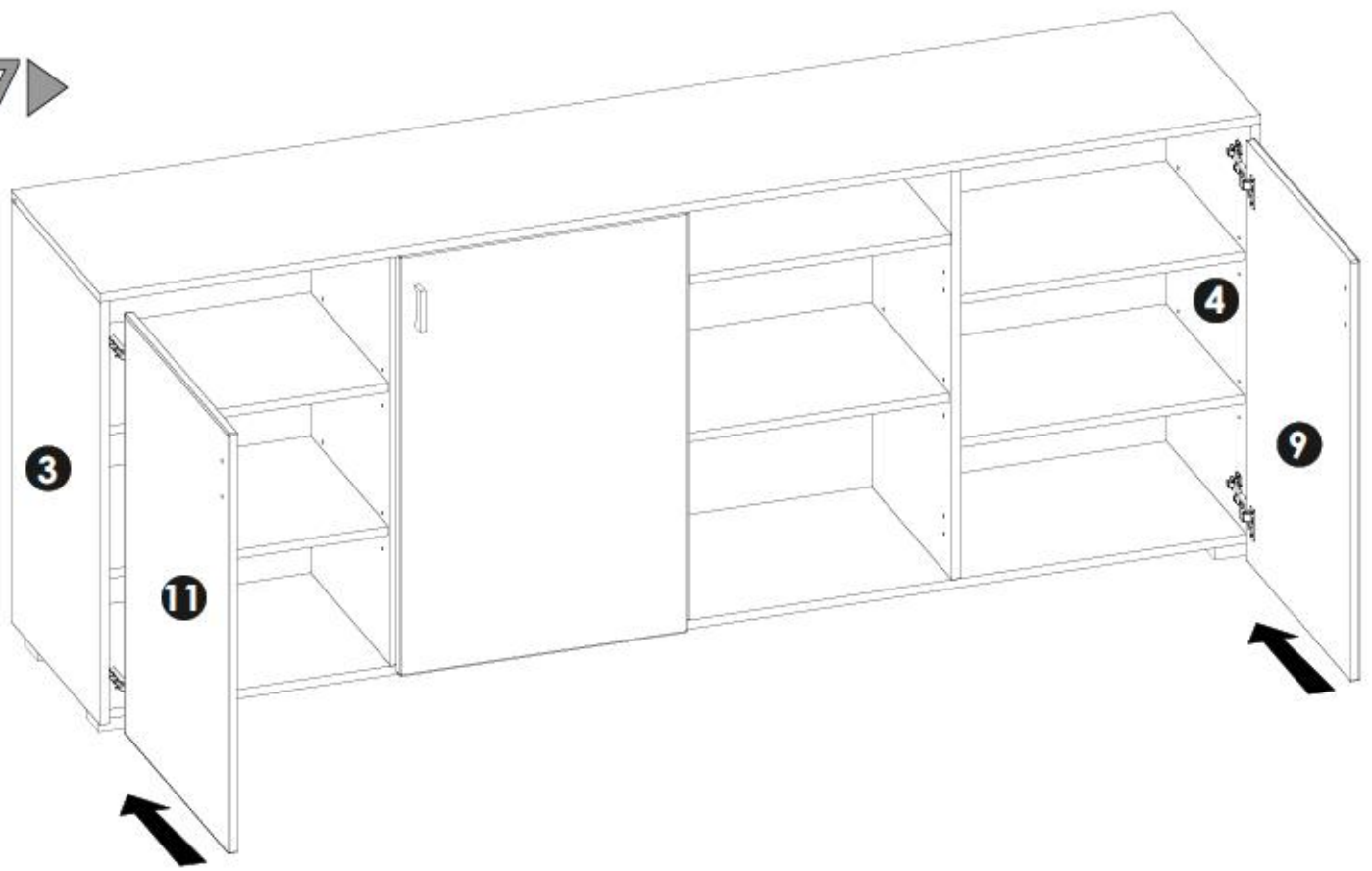

28▶

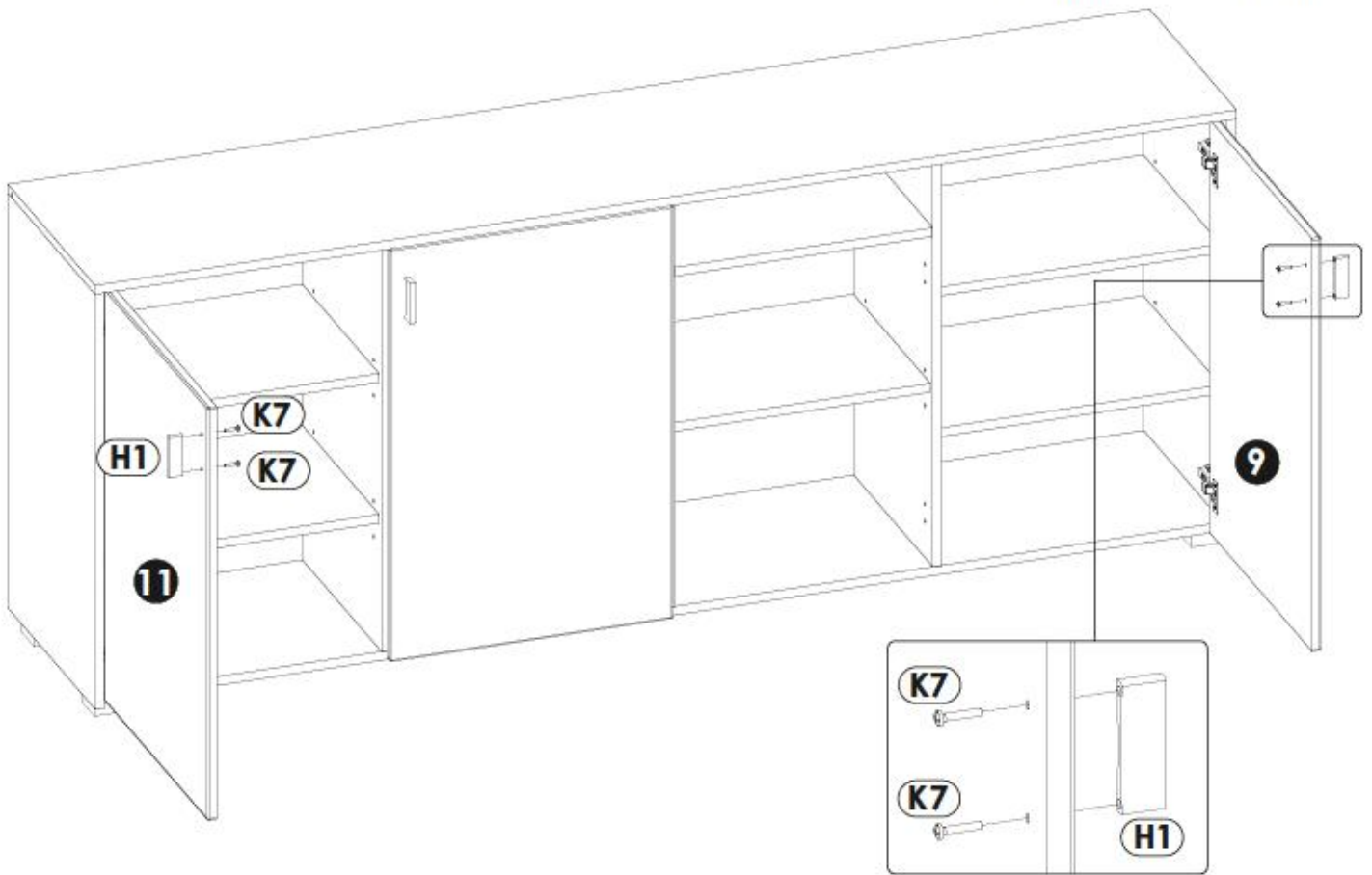
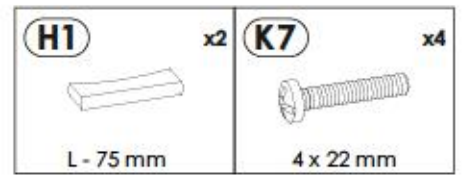

29▶

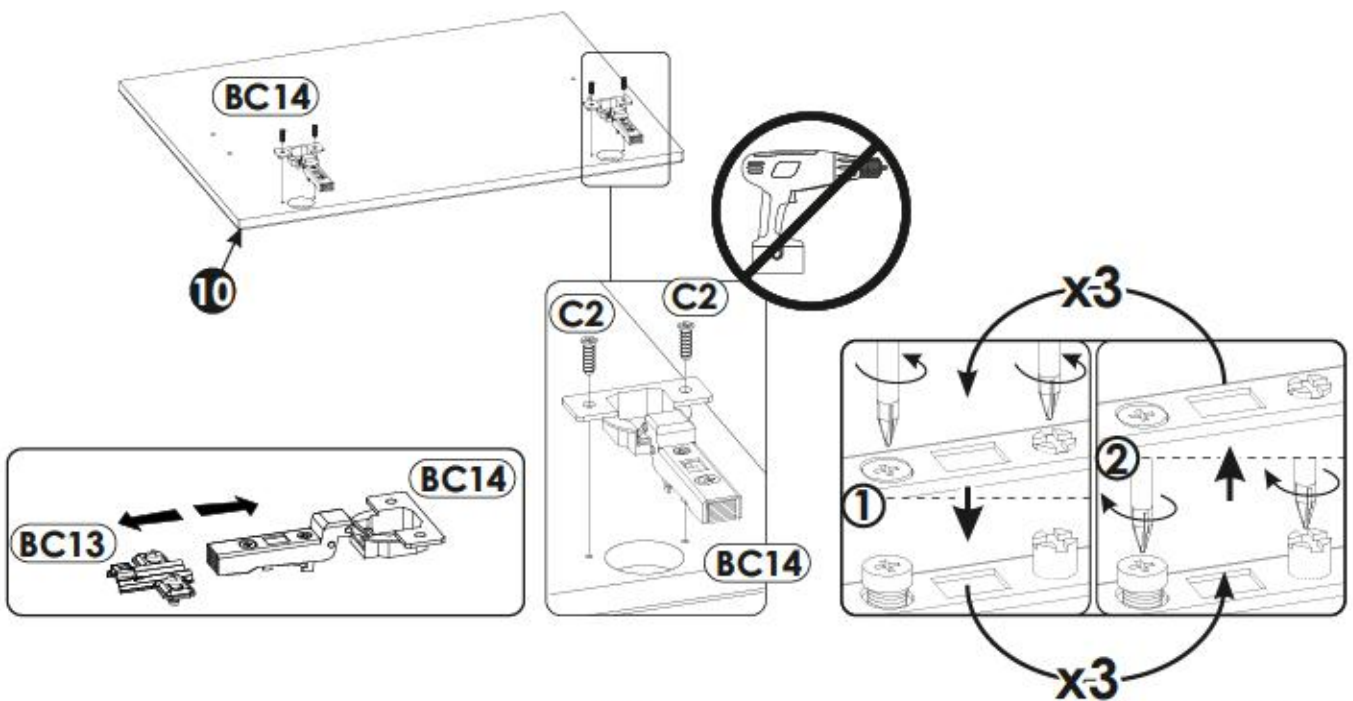
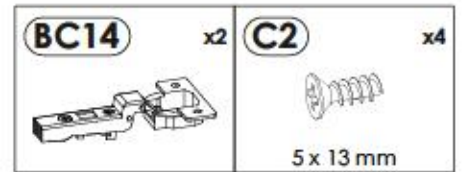

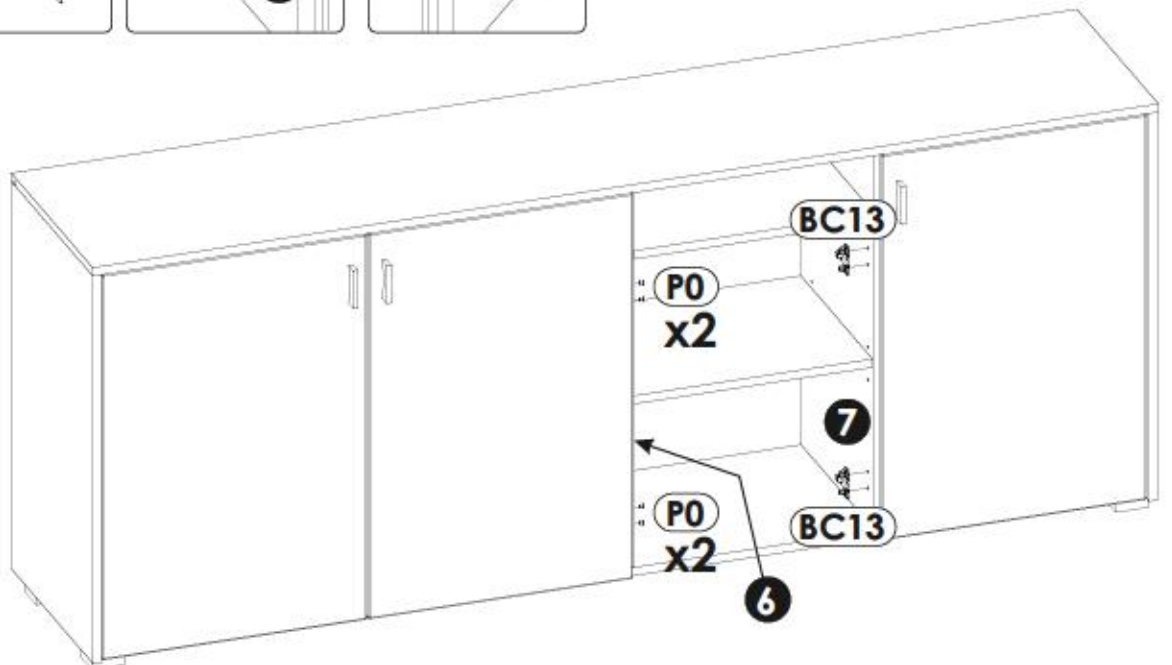
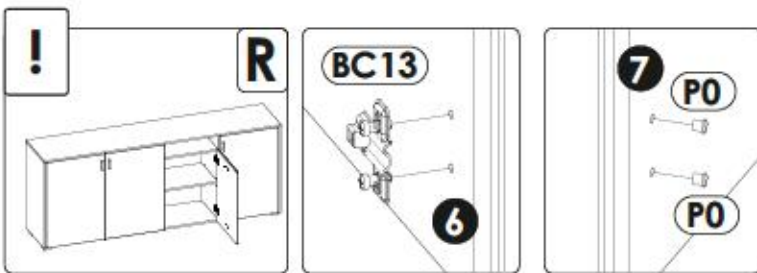
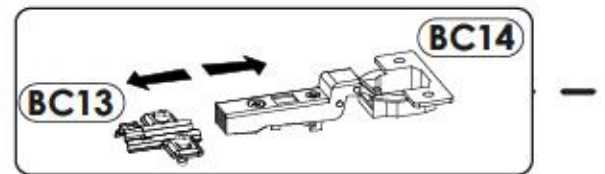
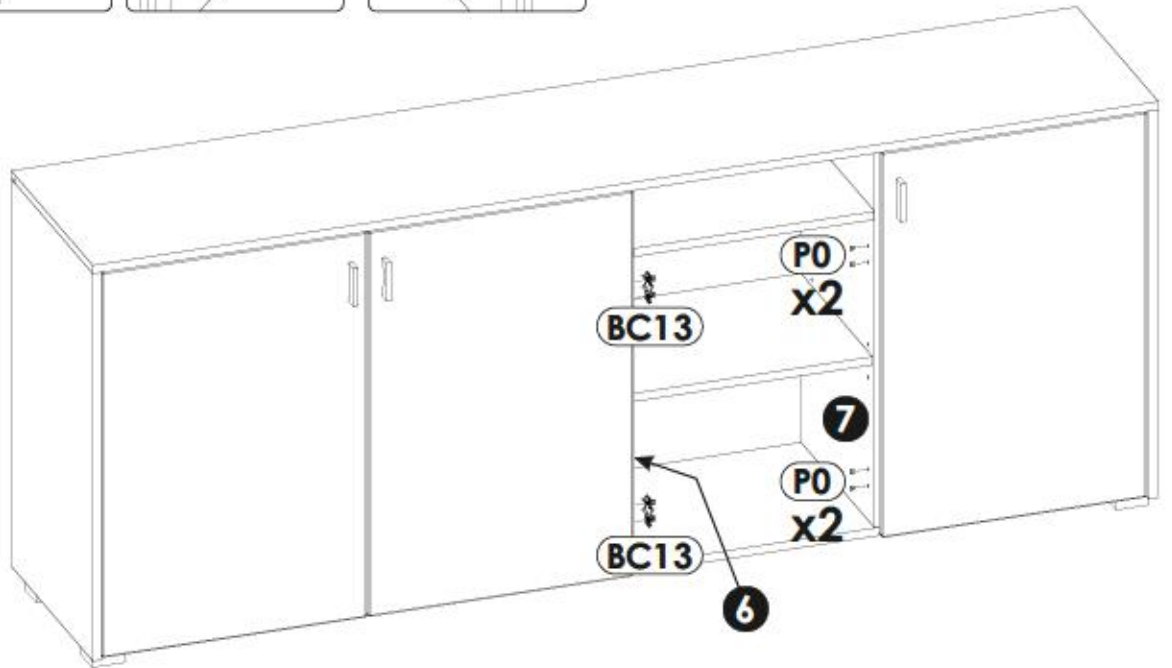
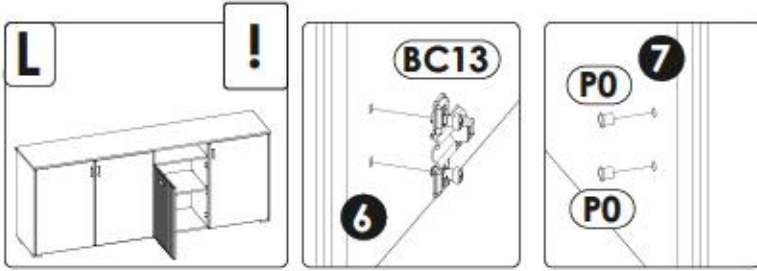
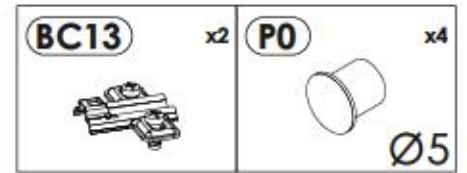

31 ▶

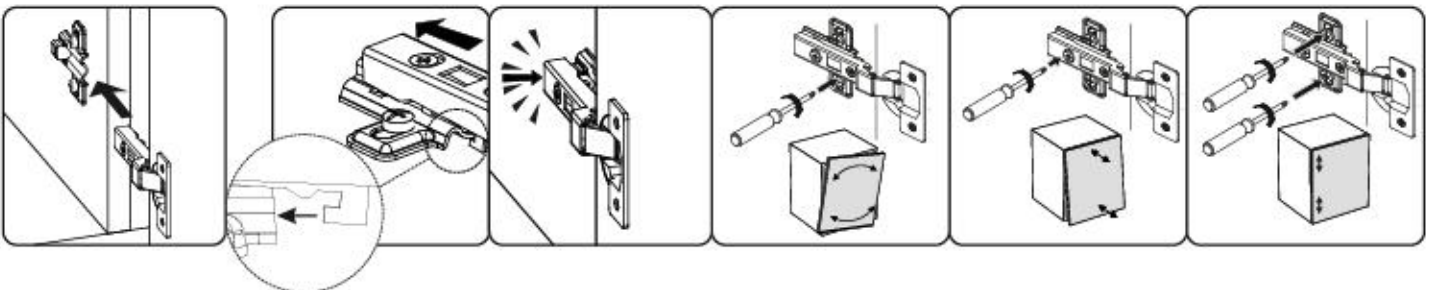
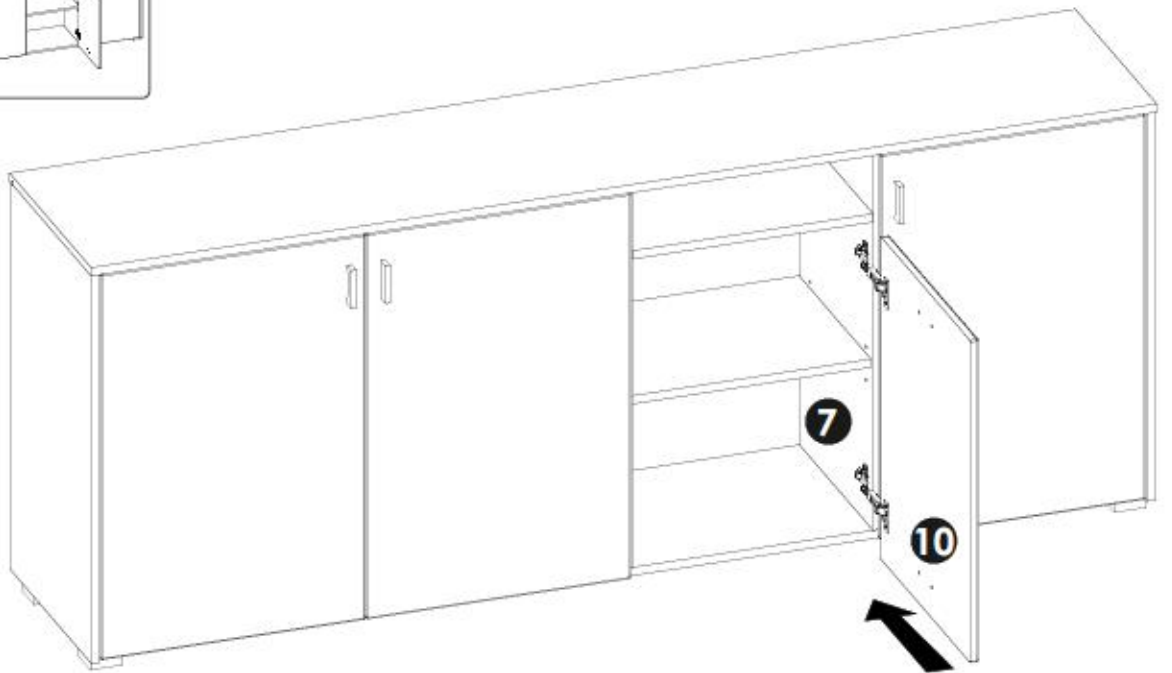
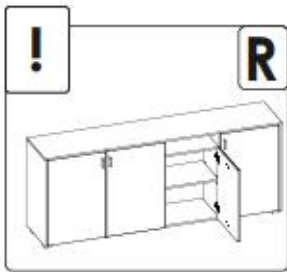
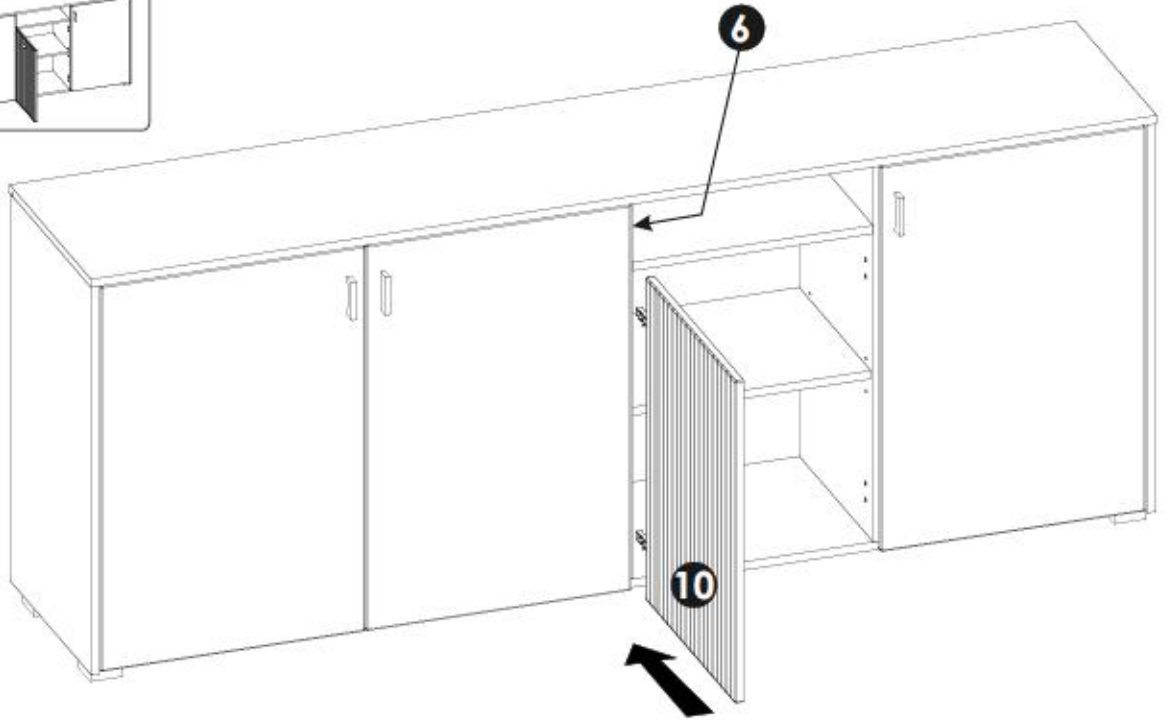
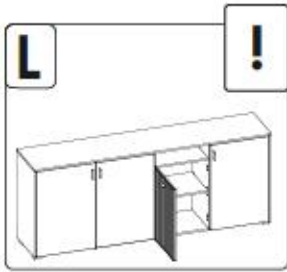

32 ▶

