

0  
10  
20  
30  
40  
50  
60  
70  
80  
90  
100  
110  
120  
130  
140  
150  
160  
170  
180  
190  
200

N	Size/MaB (mm)	Qty	✓	N	Size/MaB (mm)	Qty	✓
1	976×400	1		17	200×35	1	
2	856×353	1		18	404×202	1	
3	1802×300	1		19	300×94	1	
4	1802×300	1		20	300×94	1	
5	421×335	1		21	336×94	1	
6	421×335	1		22	297×345	1	
7	1772×335	1		23	74×40	1	
8	1860×40	1		24	1084×404	1	
9	1860×40	1		25	1084×404	1	
10	1860×40	1		26	422×404	1	
11	1860×40	1		27	1713×44	1	
12	419×330	6		28	376×44	3	
13	856×30	1		29	796×30	2	
14	1795×437	2		30	1772×30	1	
15	80×42	8		31	1772×30	1	
16	200×35	1		32	640×404	1	

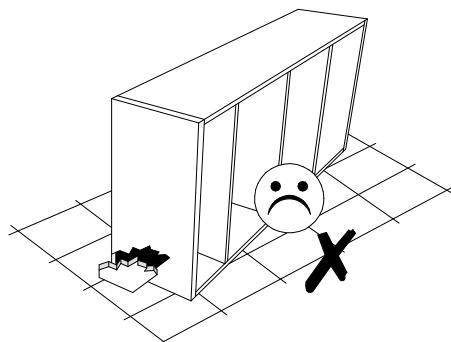

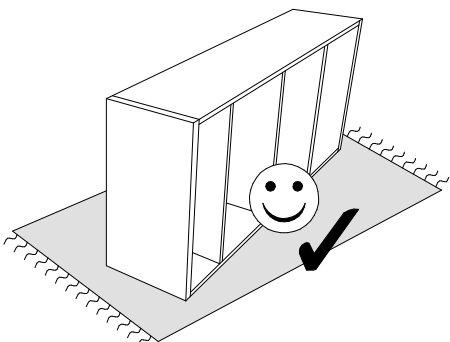

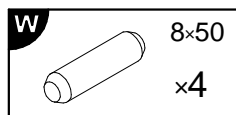
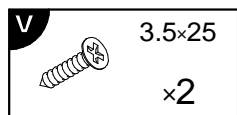
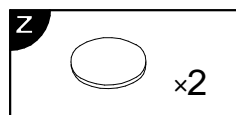
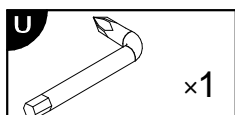
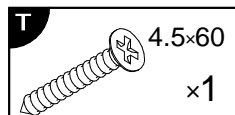
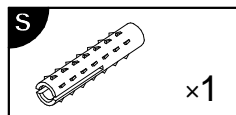
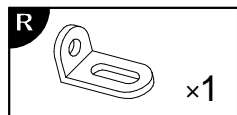
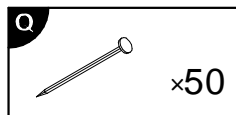
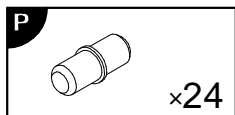
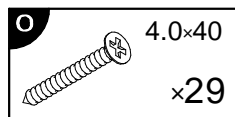
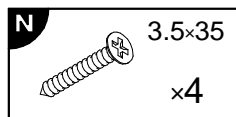
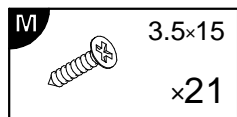
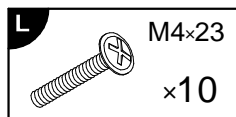
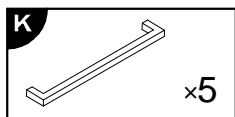
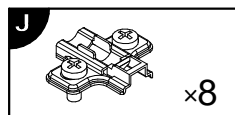
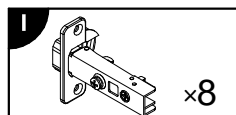
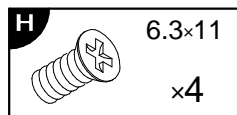
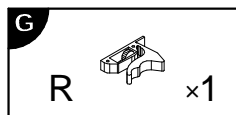
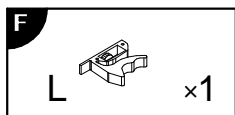
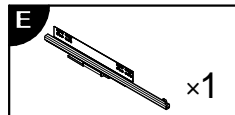
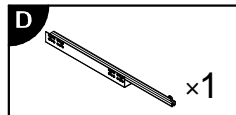
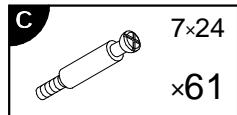
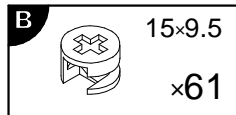
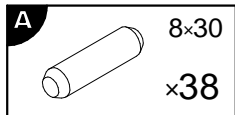
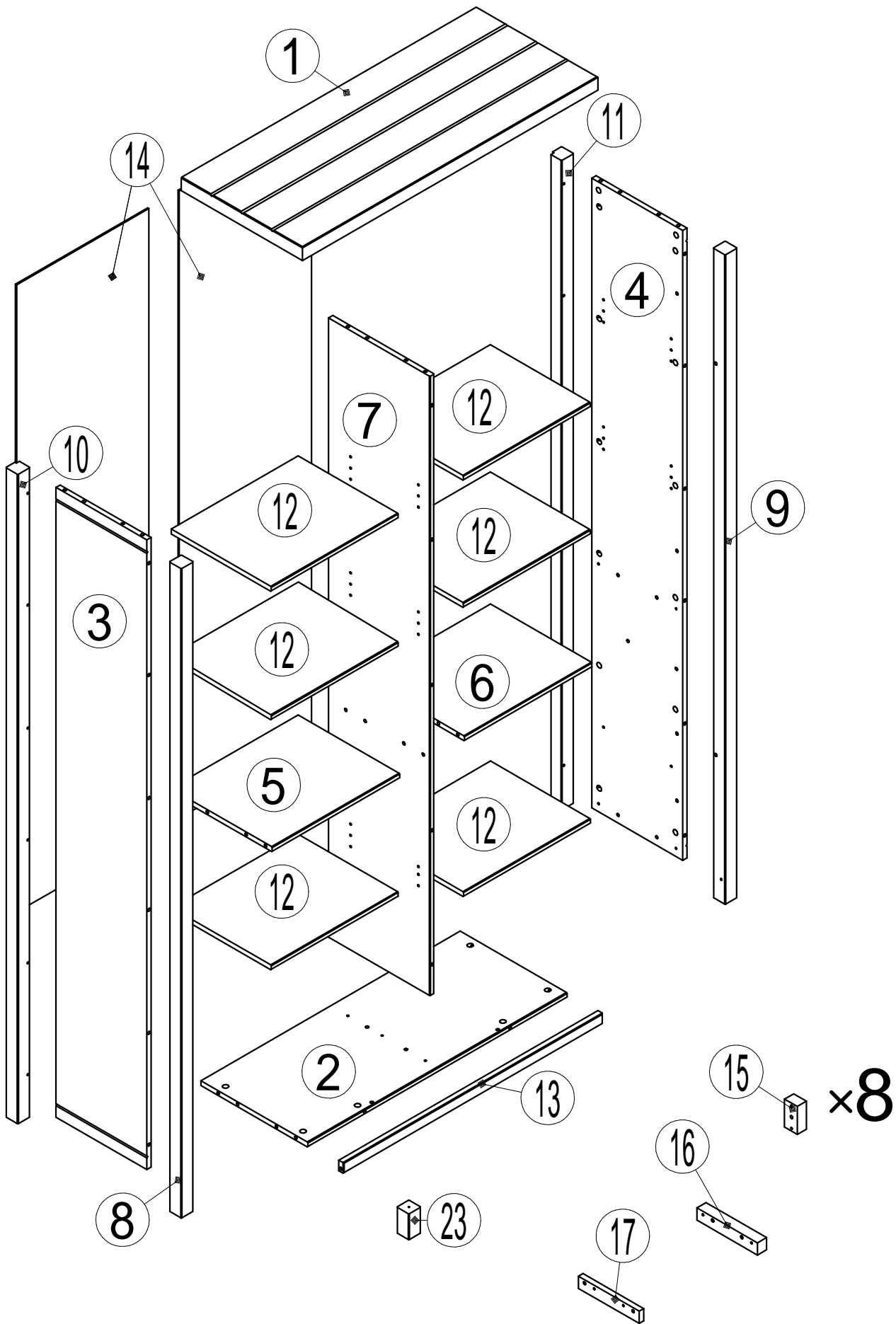
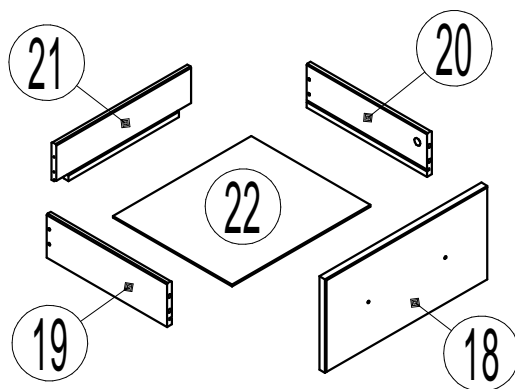
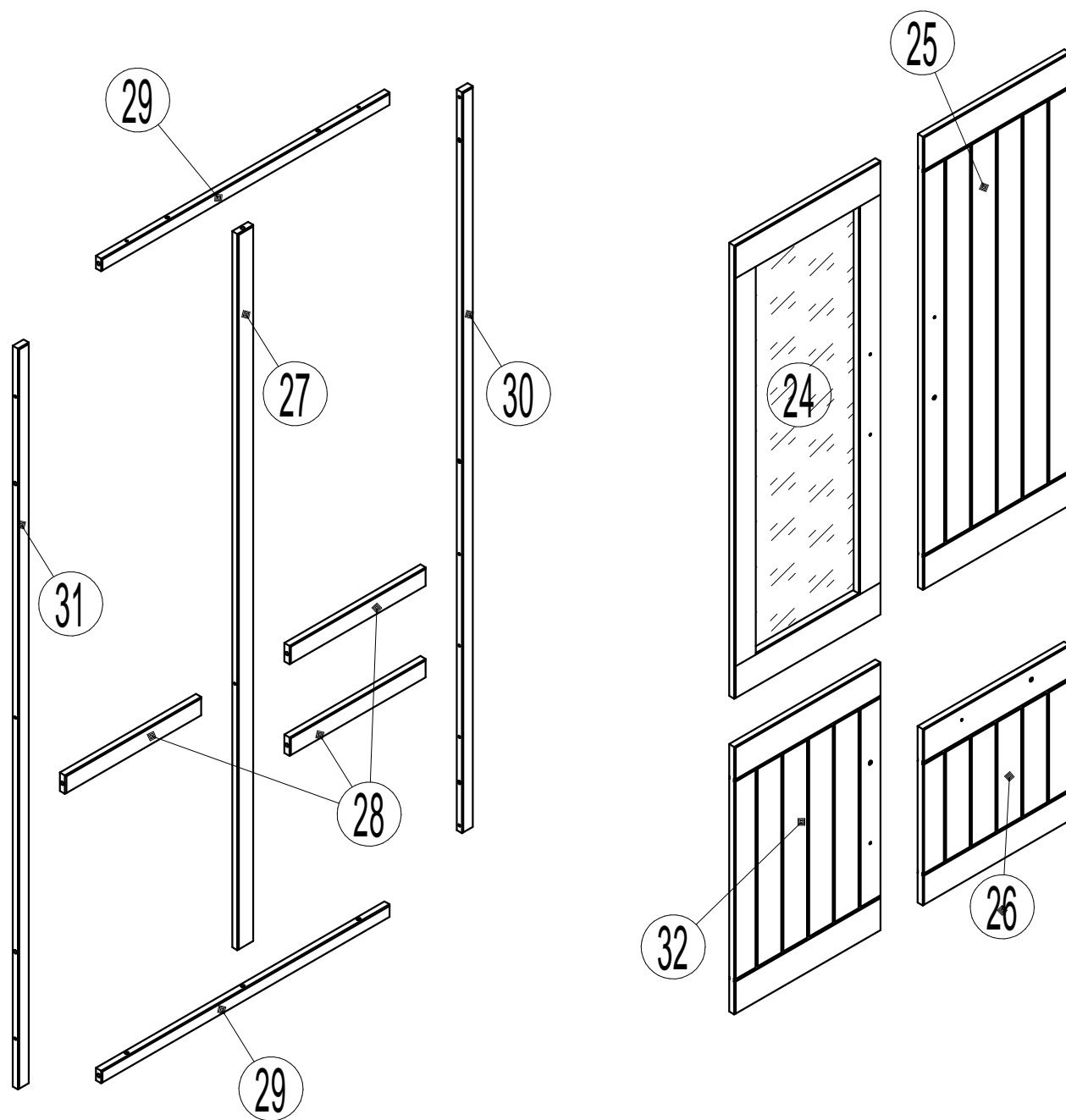

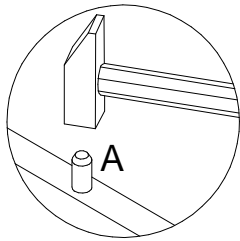
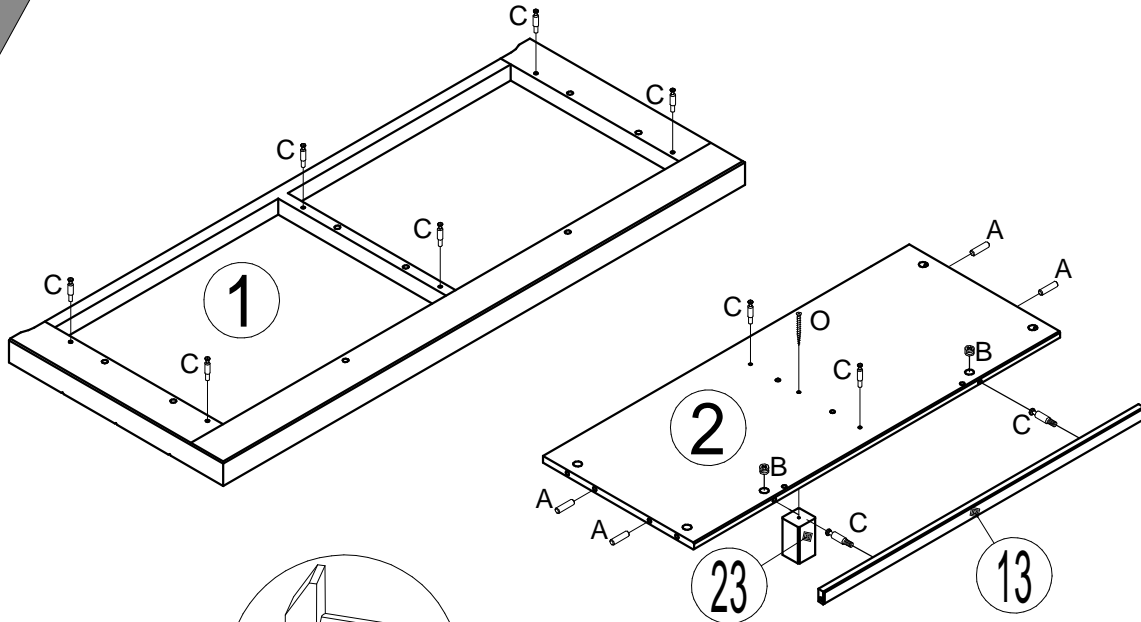

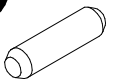

<b>A</b>		8x30 x12
----------	---	-------------

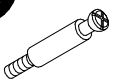
<b>B</b>		15x9.5 x7
----------	---	--------------

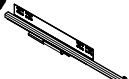
<b>C</b>		7x24 x18
----------	---	-------------

<b>E</b>		x1
----------	---	----

<b>H</b>		6.3x11 x2
----------	---	--------------





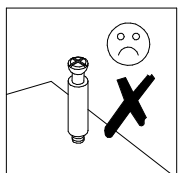
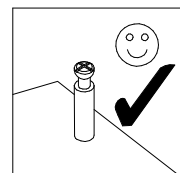
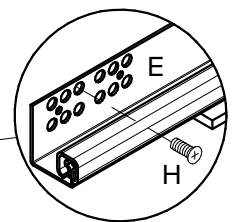
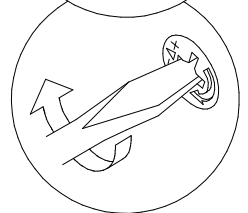
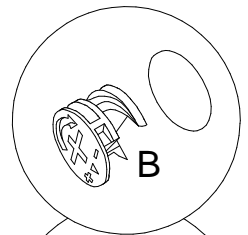
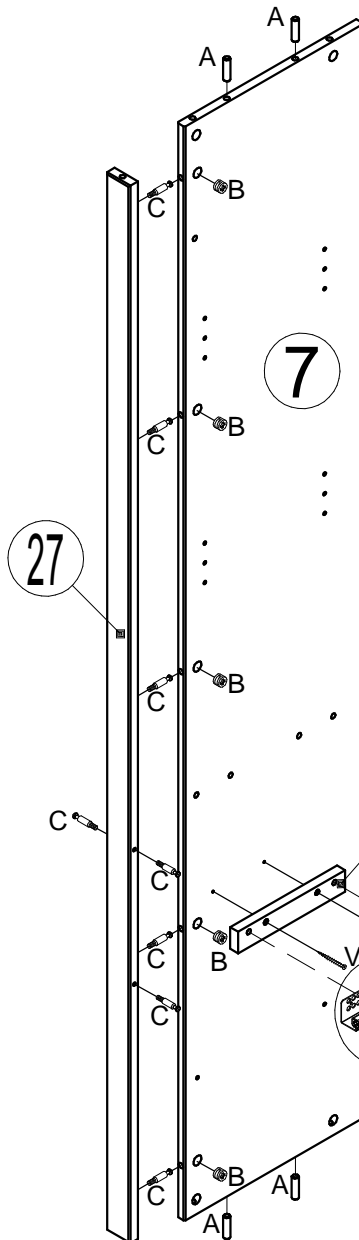
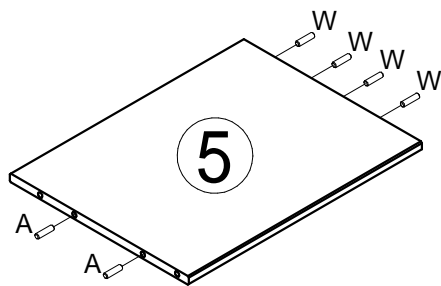
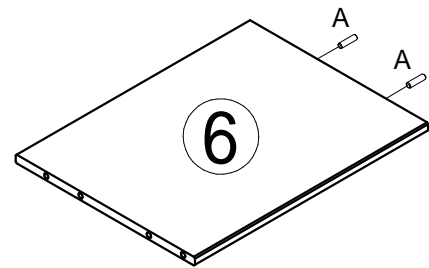

<b>O</b>		4.0x40 x1
----------	---	--------------

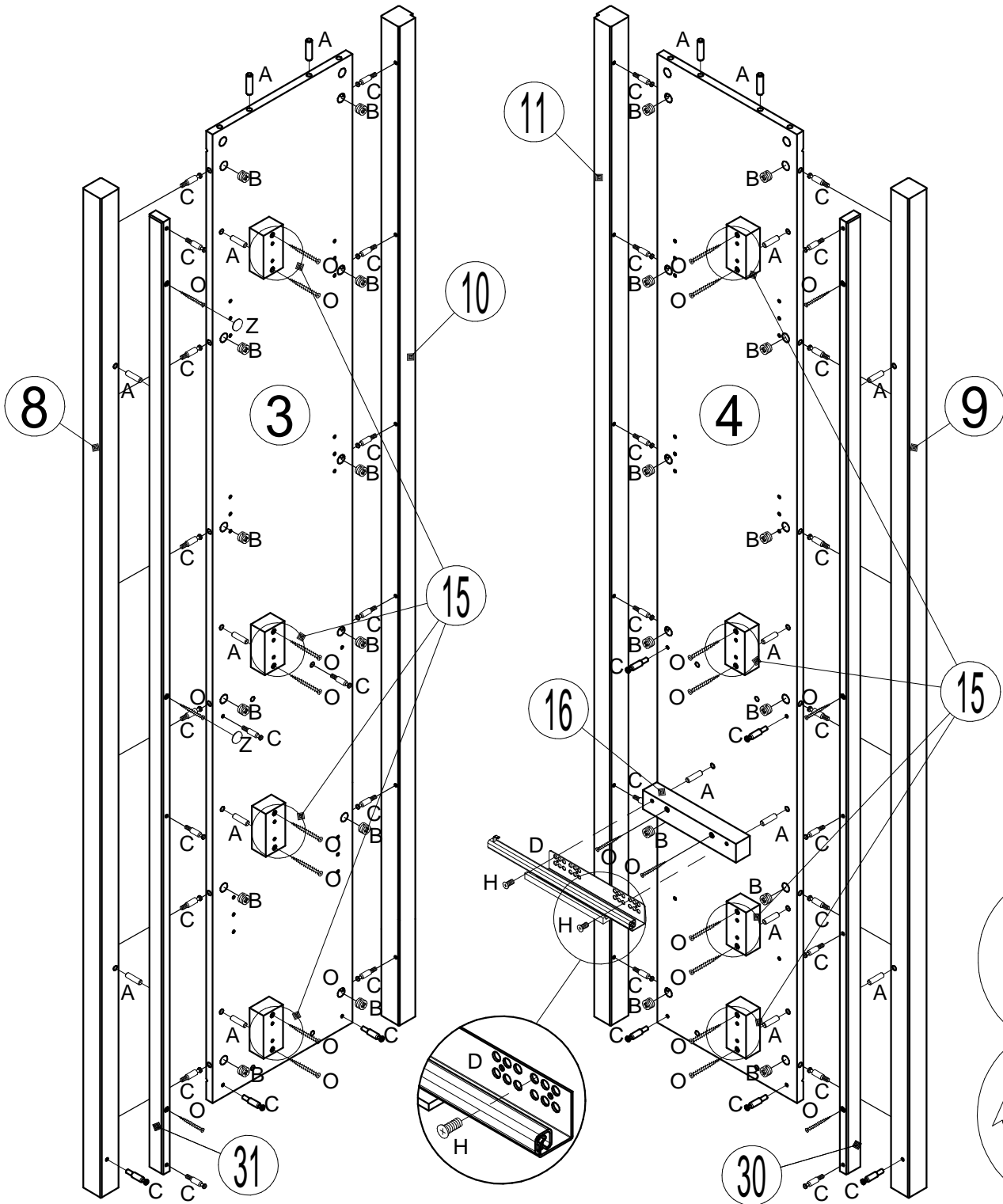
<b>W</b>		8x50 x4
----------	---	------------

<b>V</b>		3.5x25 x2
----------	--	--------------

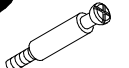
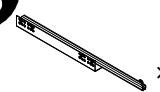



- A**  8x30  
x18
- B**  15x9.5  
x24
- C**  7x24  
x41
- D**  x1
- O**  4.0x40  
x24
- Z**  x2
- H**  6.3x11  
x2

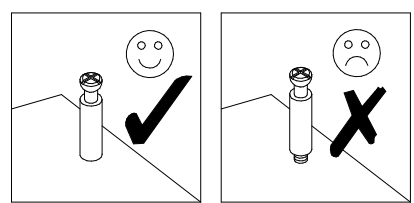
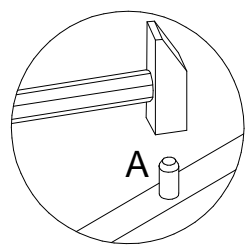
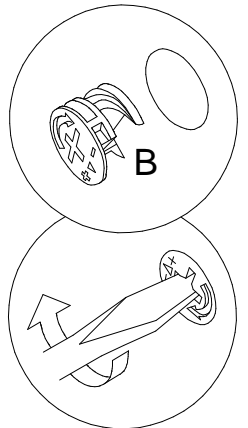

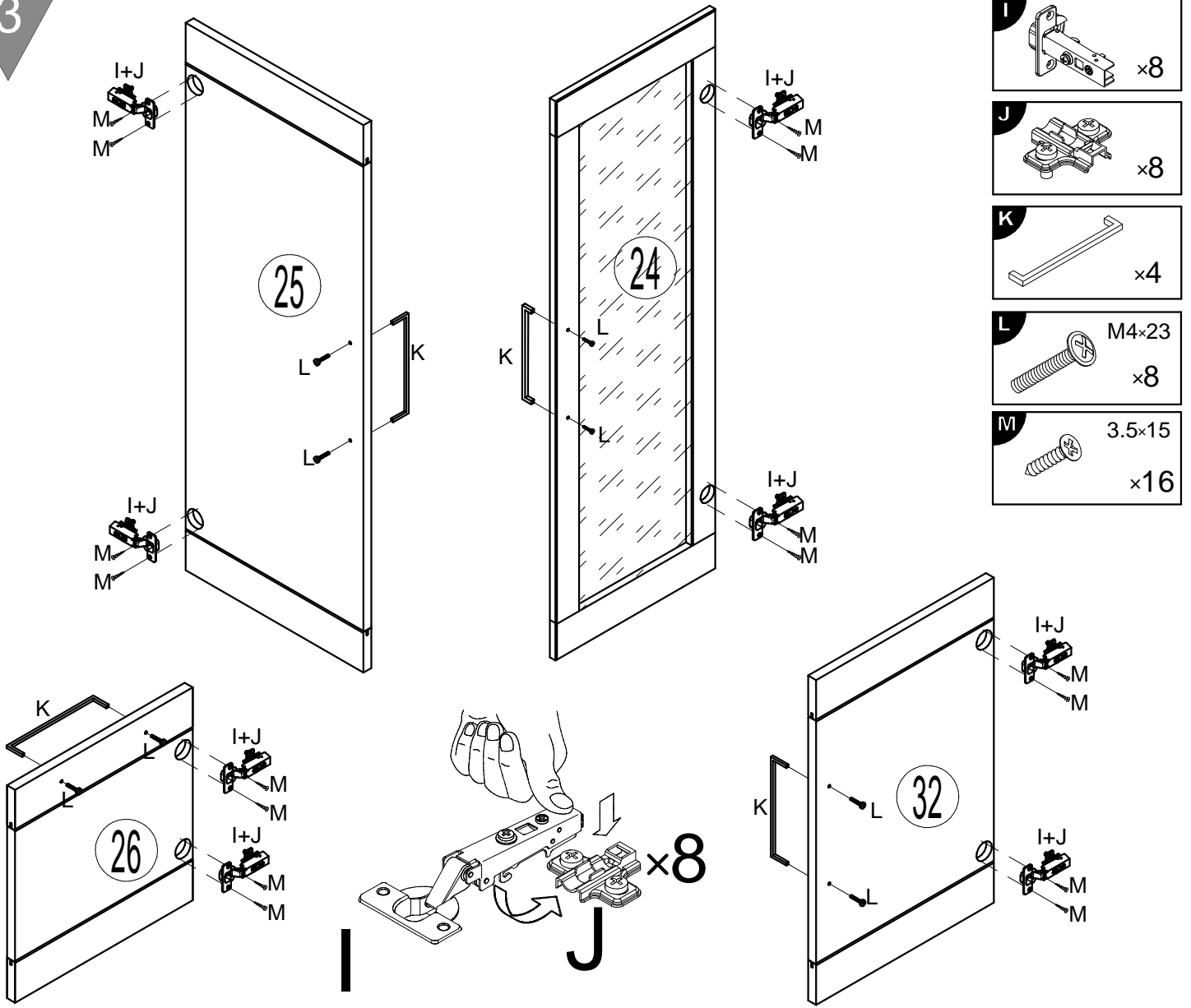

3

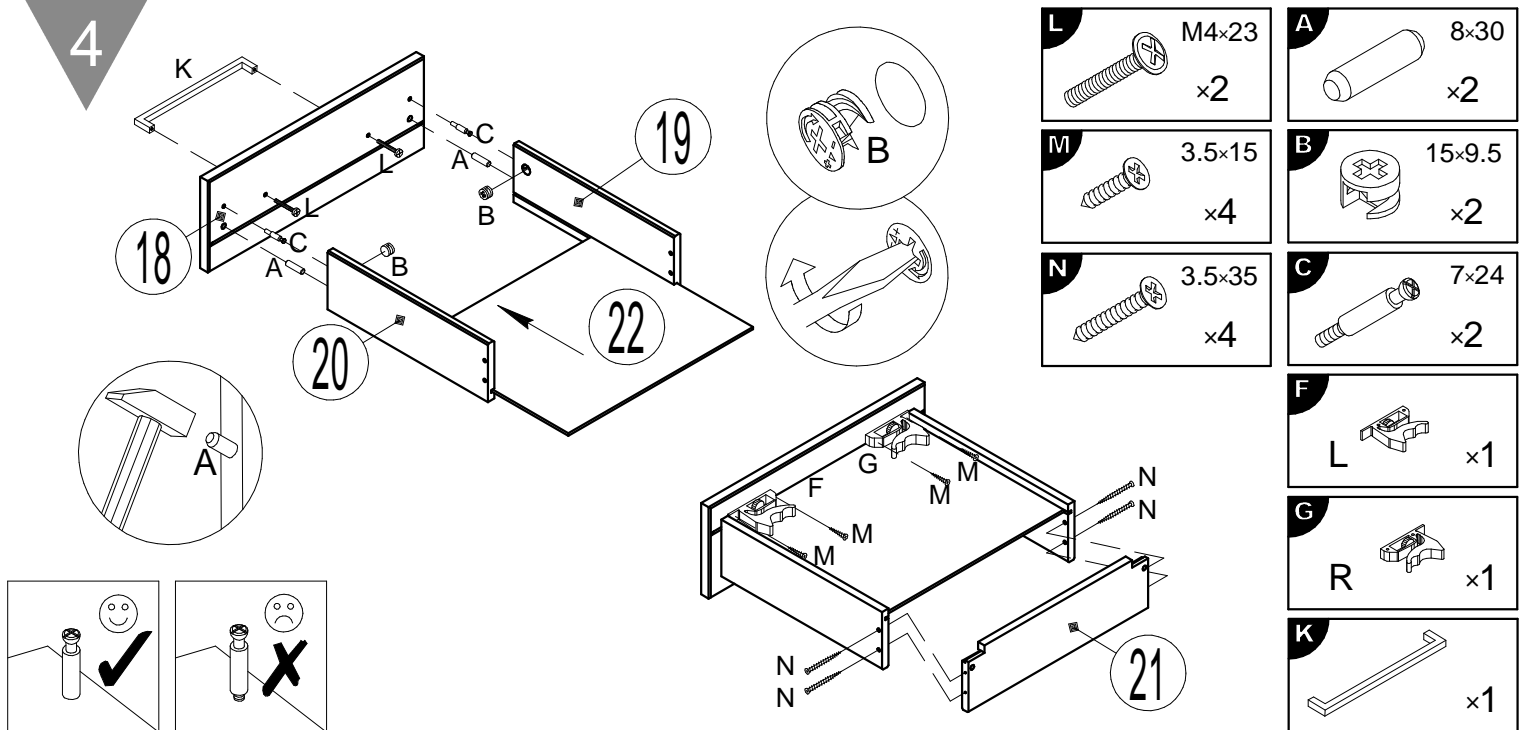

4

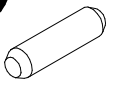

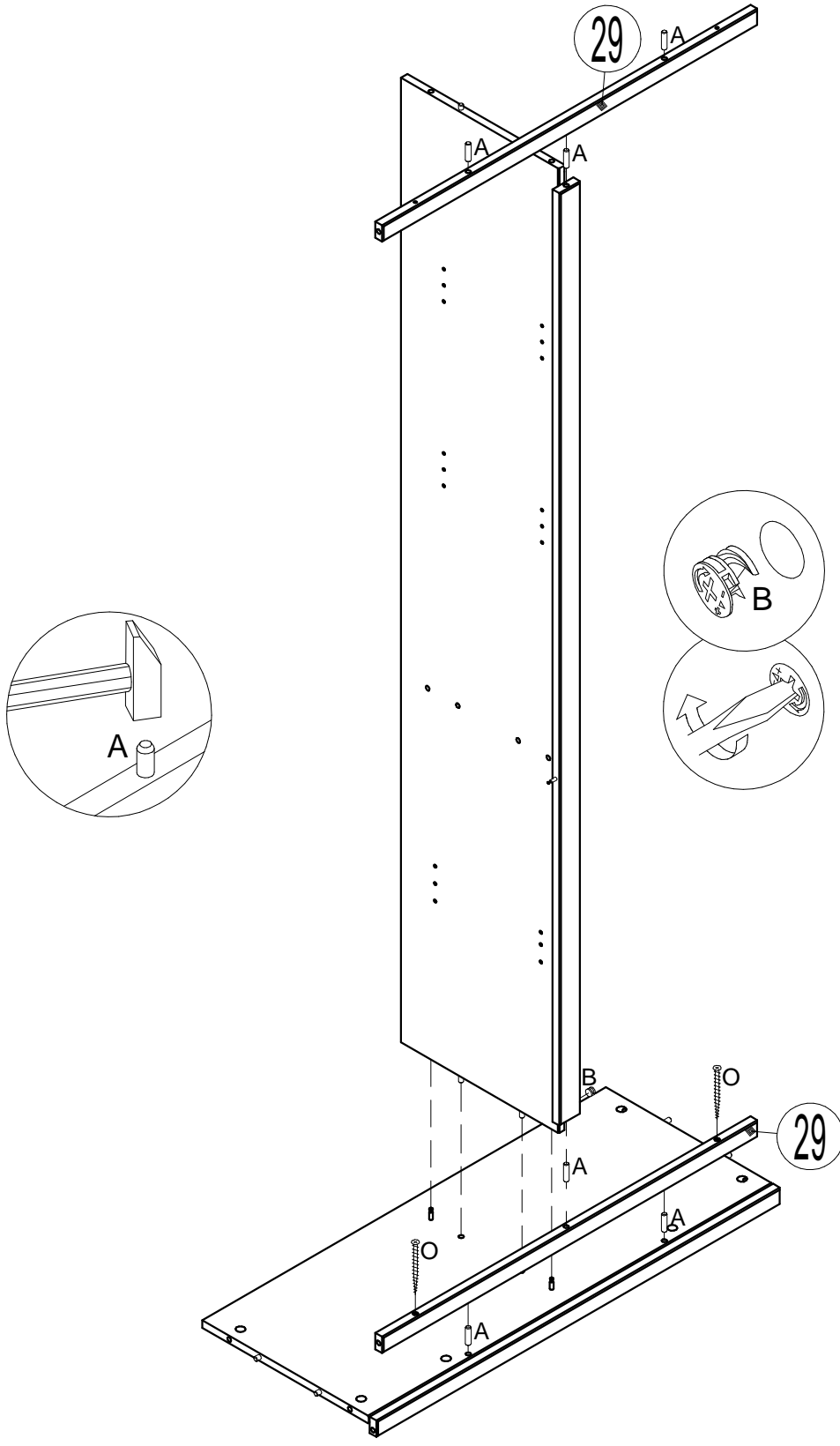

<b>A</b>		8x30 x6
<b>B</b>		15x9.5 x2
<b>O</b>		4.0x40 x2



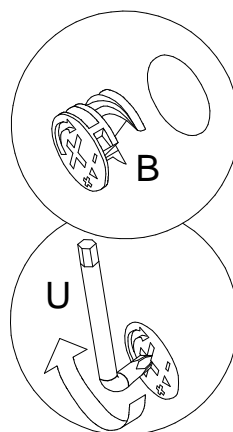
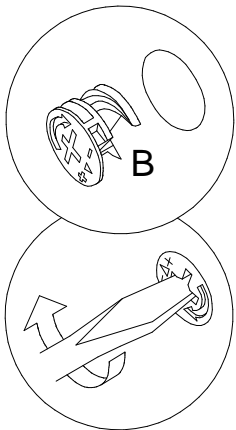
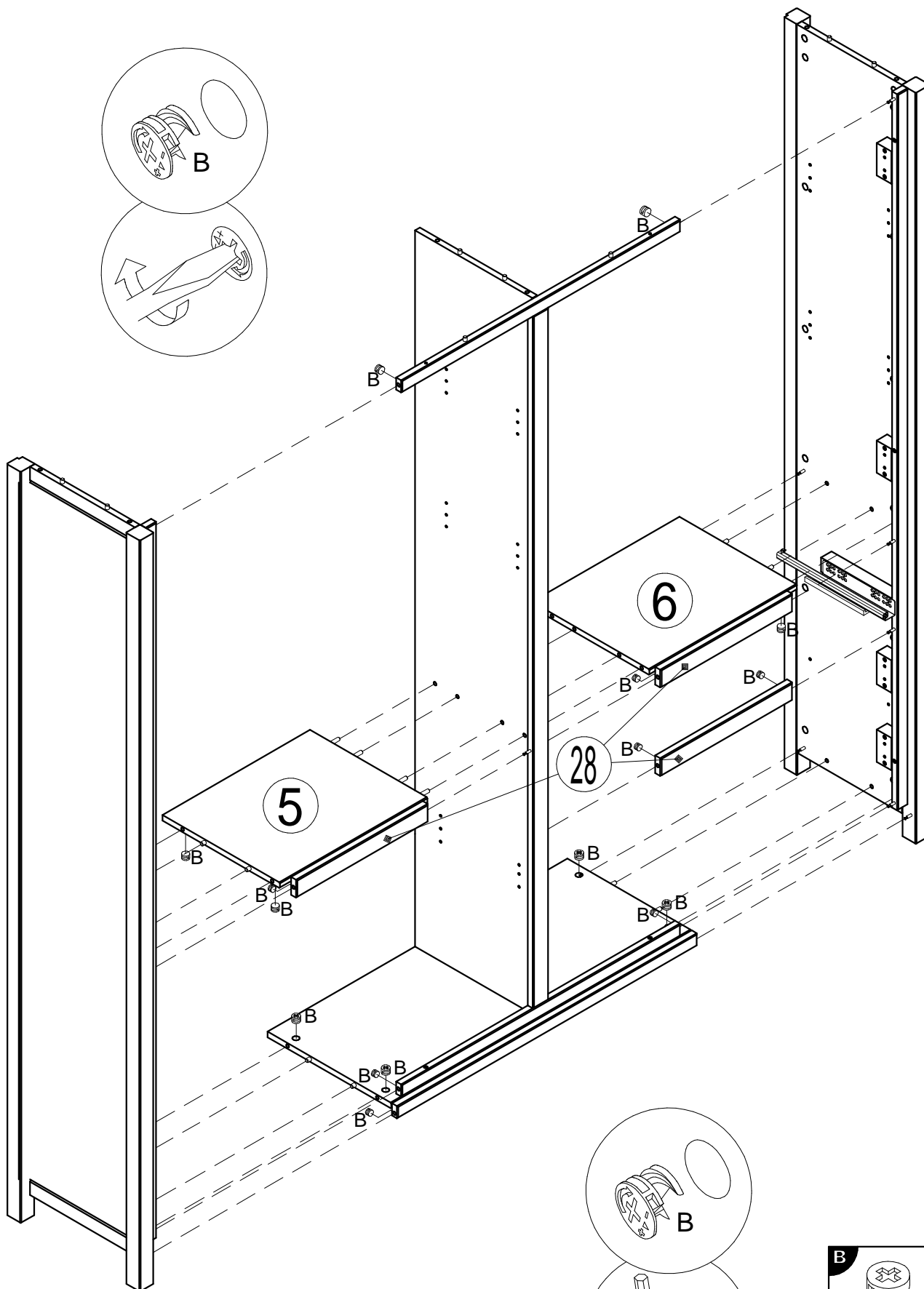





<b>B</b>	15x9.5
	x20

<b>U</b>	x1
	

**B** 15x9.5  
x6

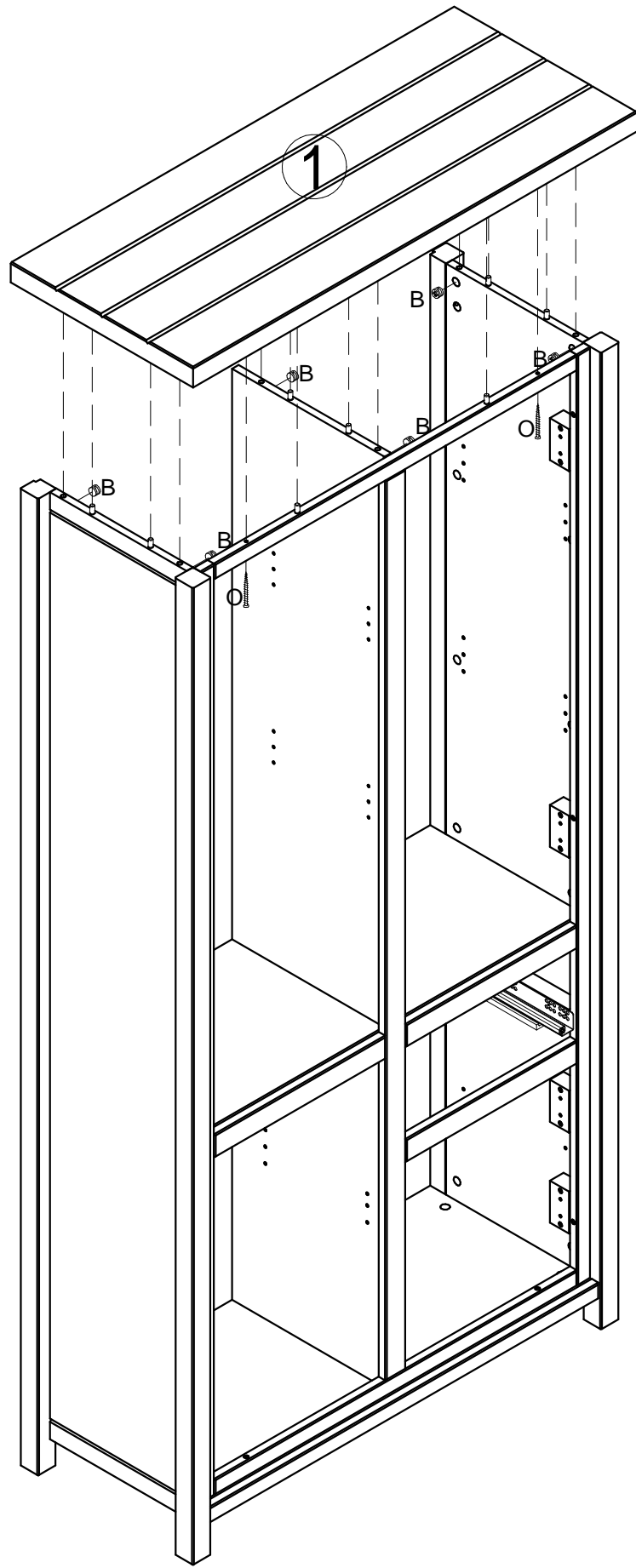
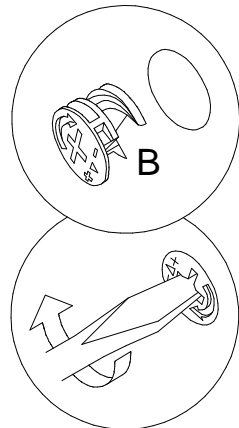

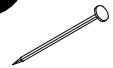

**O** 4.0x40  
x2

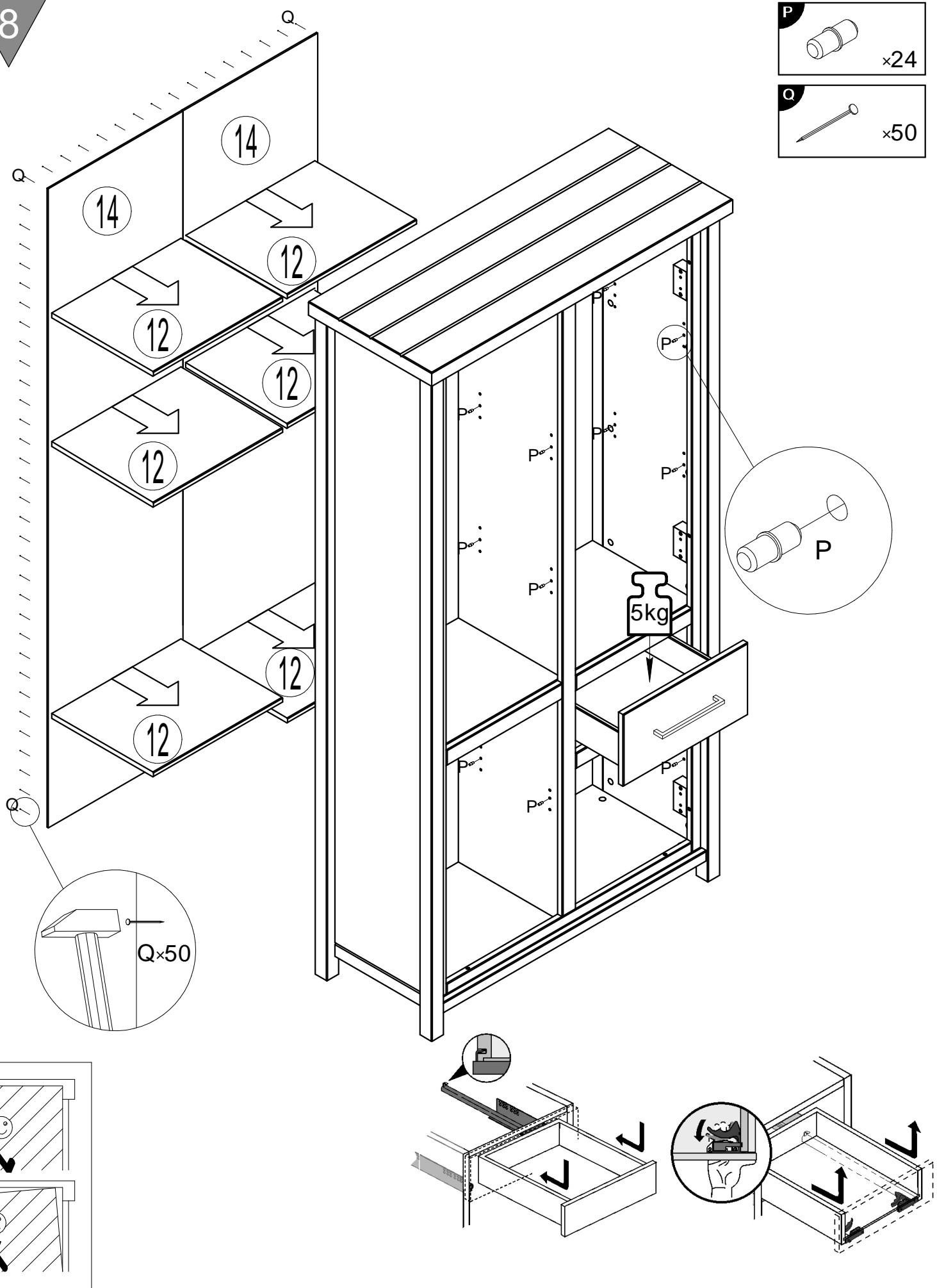

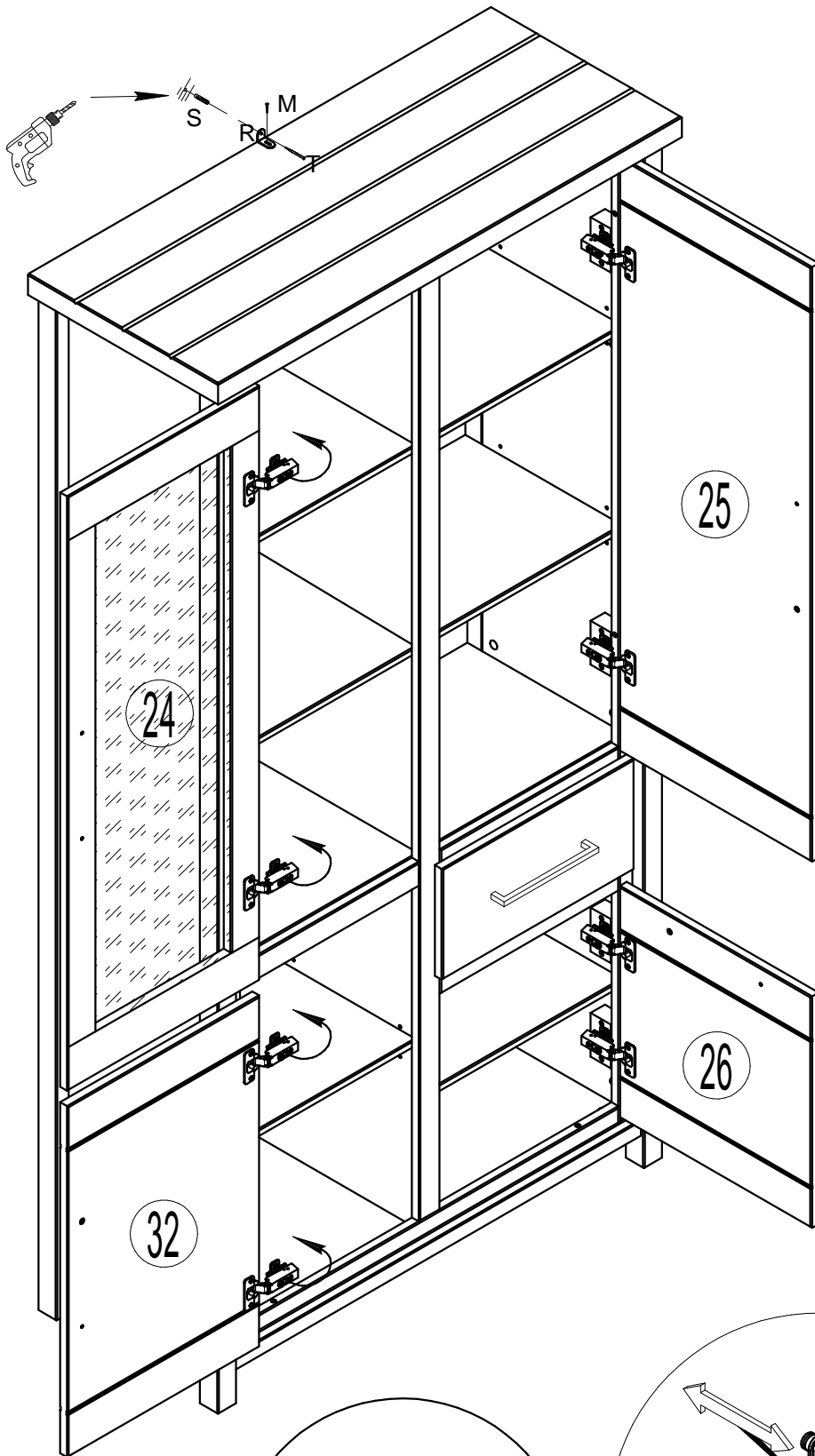
- P**  x24
- Q**  x50



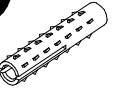

- M**  3.5x15  
x1
- R**  x1
- S**  x1
- T**  4.5x60  
x1

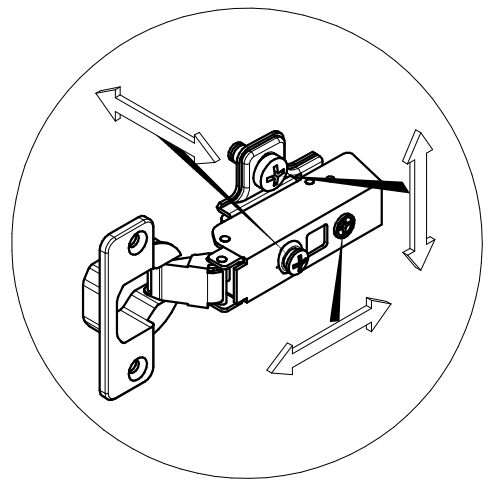
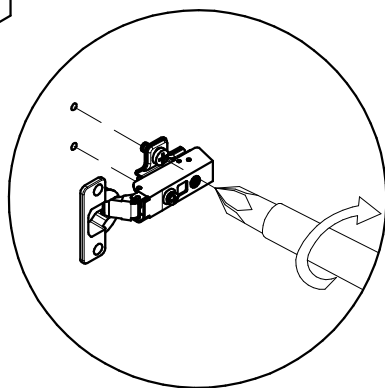



**Achtung • Attention • Attenzione  
Opgelet • Uwaga • Pozor • Figyelem  
Atenție • Dikkat • Внимание**



<b>(D)</b>	Wandbefestigung dient als Kippschutz – unbedingt anbringen! Bei einigen Wandtypen kann ein Spezialdübel erforderlich sein!
<b>(GB)</b>	The wall fastening serves to prevent tipping – be absolutely sure to mount it! For certain wall types, a special wall plug may be necessary!
<b>(FR)</b>	La fixation murale sert de protection contre le basculement – à installer impérativement ! Pour certains types de murs il faut des chevilles spéciales !
<b>(IT)</b>	Il fissaggio alla parete serve da protezione anti-ribaltamento – attaccarla assolutamente! Per alcune strutture di parete può essere necessario un tassello speciale!
<b>(NL)</b>	Bevestiging aan de muur dient als kantelbescherming – zeker en vast bevestigen! Bij enkele muurtypes is een speciale plug misschien vereist!
<b>(PL)</b>	Mocowanie do ściany jest jednocześnie zabezpieczeniem przed przewróceniem – koniecznie zamontować! Do niektórych rodzajów ścian koniecznie zastosować specjalne kołki mocujące.
<b>(CZ)</b>	Montáž na stěnu slouží jako ochrana proti převrnutí – bezpodmienečně umístěte! U některých typů stěn může být zapotřebí speciální hmoždinka!
<b>(SK)</b>	Upevnenie na stenu slúži ako ochrana proti prevráteniu – bezpodmienečne použite! Pre niektoré druhy stien môže byť potrebná špeciálna hmoždinka!
<b>(HU)</b>	A terméket a falhoz kel rögzíténi, különben az felborulhat! Egyes faltípusoknál speciális tiplit kell használni!
<b>(RO)</b>	Sistemul de fixare la perete servește ca protecție la răsturnare – de montat obligatoriu! Pentru unele tipuri de pereți este posibil să fie necesar un diblu special!
<b>(TR)</b>	Duvardaki sabitleme, devrilmeye karşı bir emniyet tedbiridir ve mutlaka monte edilmelidir! Bazı duvar tiplerinde bunun için özel bir dübel gerekli olabilir!
<b>(RU)</b>	Обязательно установите крепление на стене во избежание опрокидывания! Для некоторых типов стен может потребоваться специальный дюбель!