

*Domeo 6 v2*  
*Art. Nr. 4426019*  
1/29

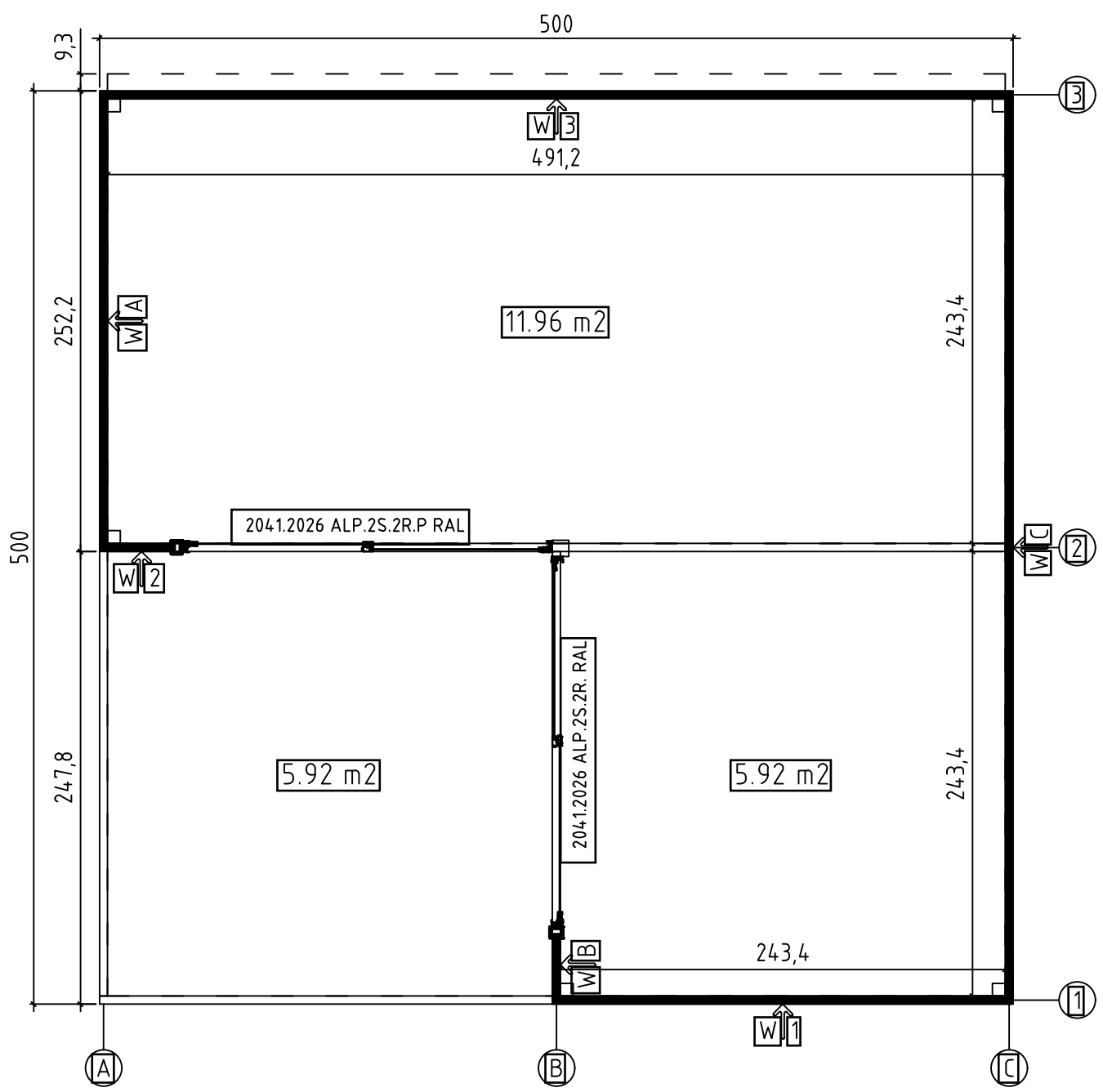

Art. Nr. 4426019

Groundplan - Grundplan - Plan de masse -  
Planimetria - Plattegrond - Põhiplaan



29.10.2020

2/29

Foundation - Fundament - Fondation - Fundamenta - Fundering -  
Immutatud alusraam

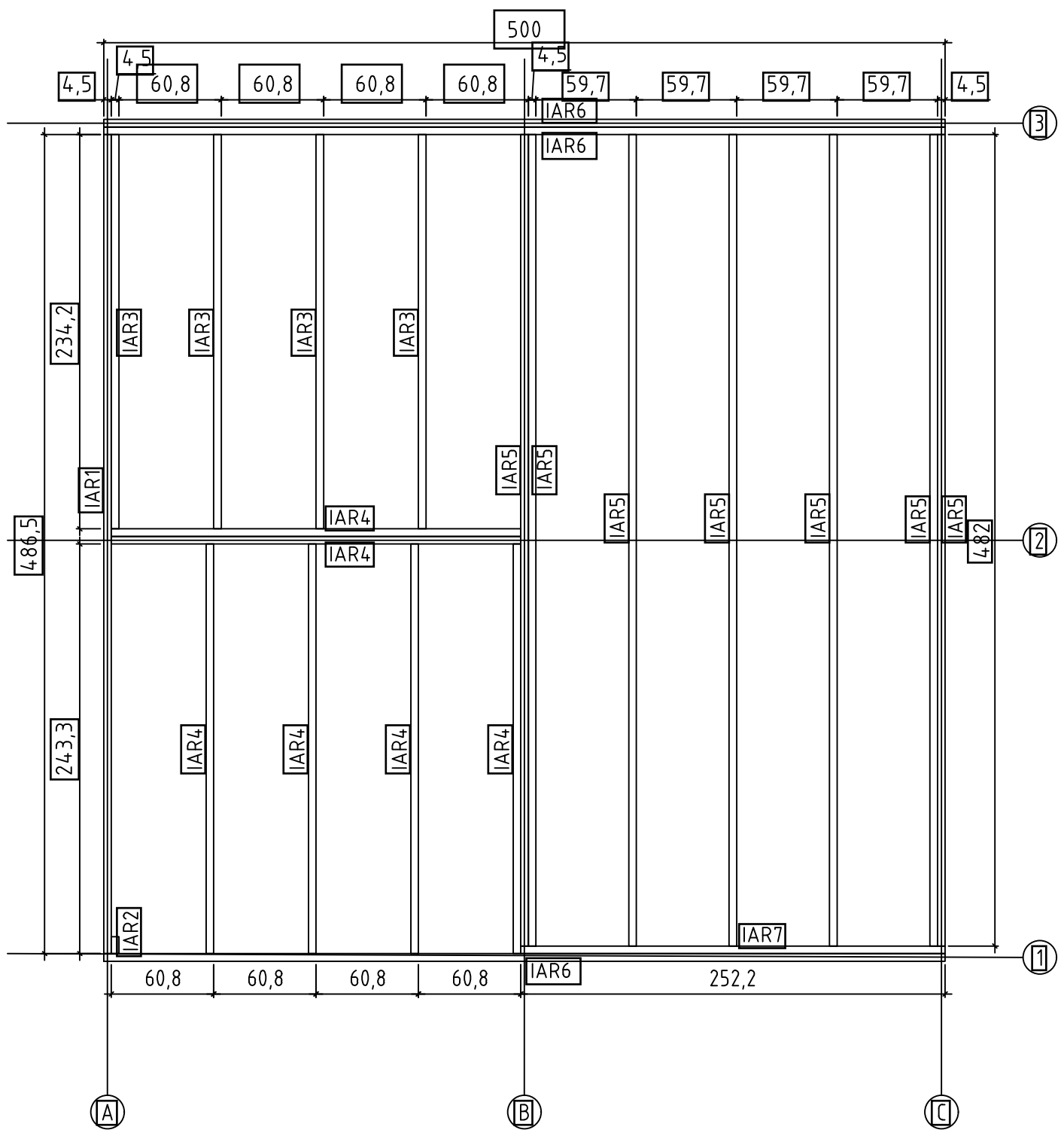

Art. Nr. 4426019

Floor boards - Fussbodenbretter - Plan pose plancher - Pavimento  
- Vloerhout - Põrandataudis

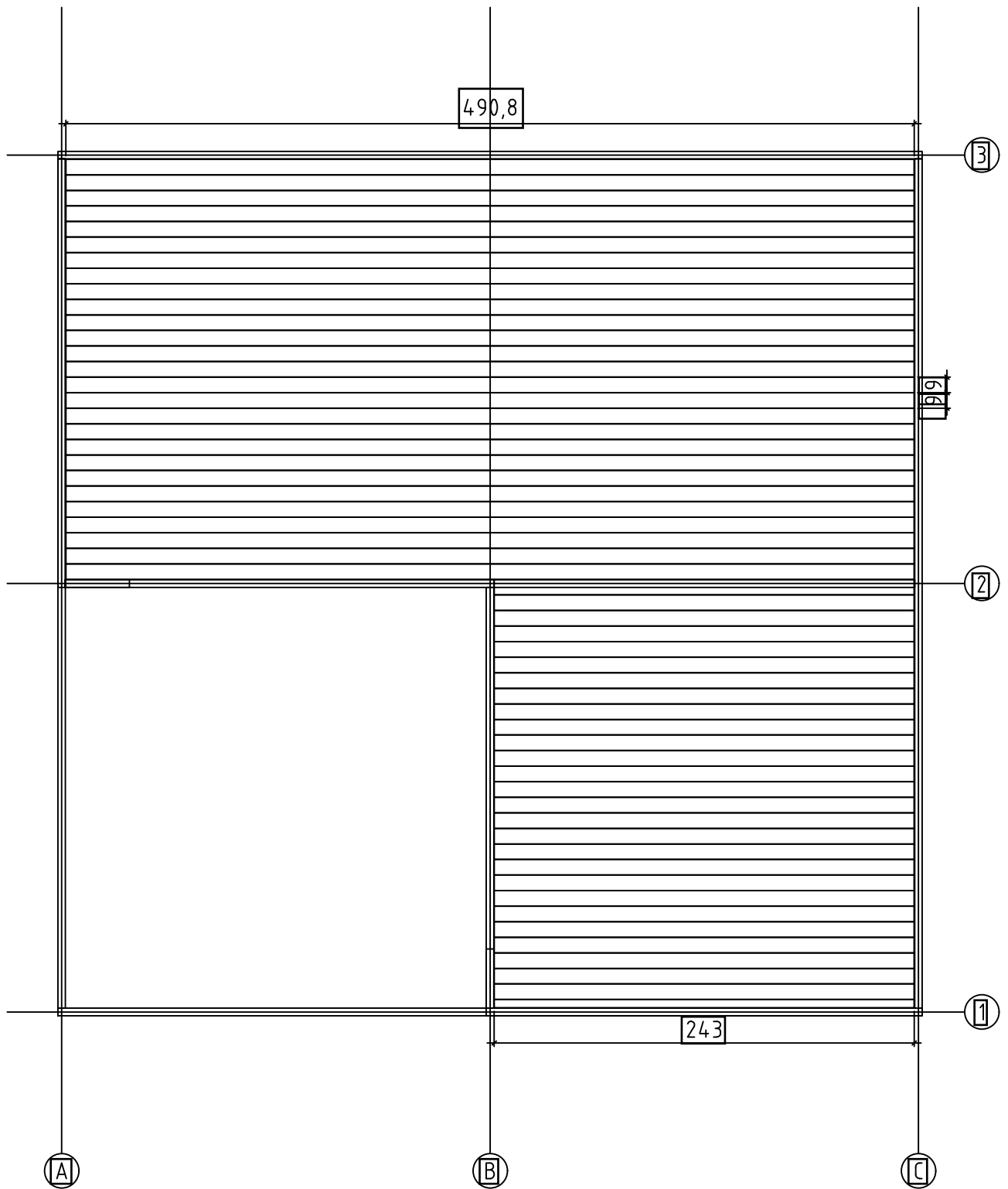

29.10.2020





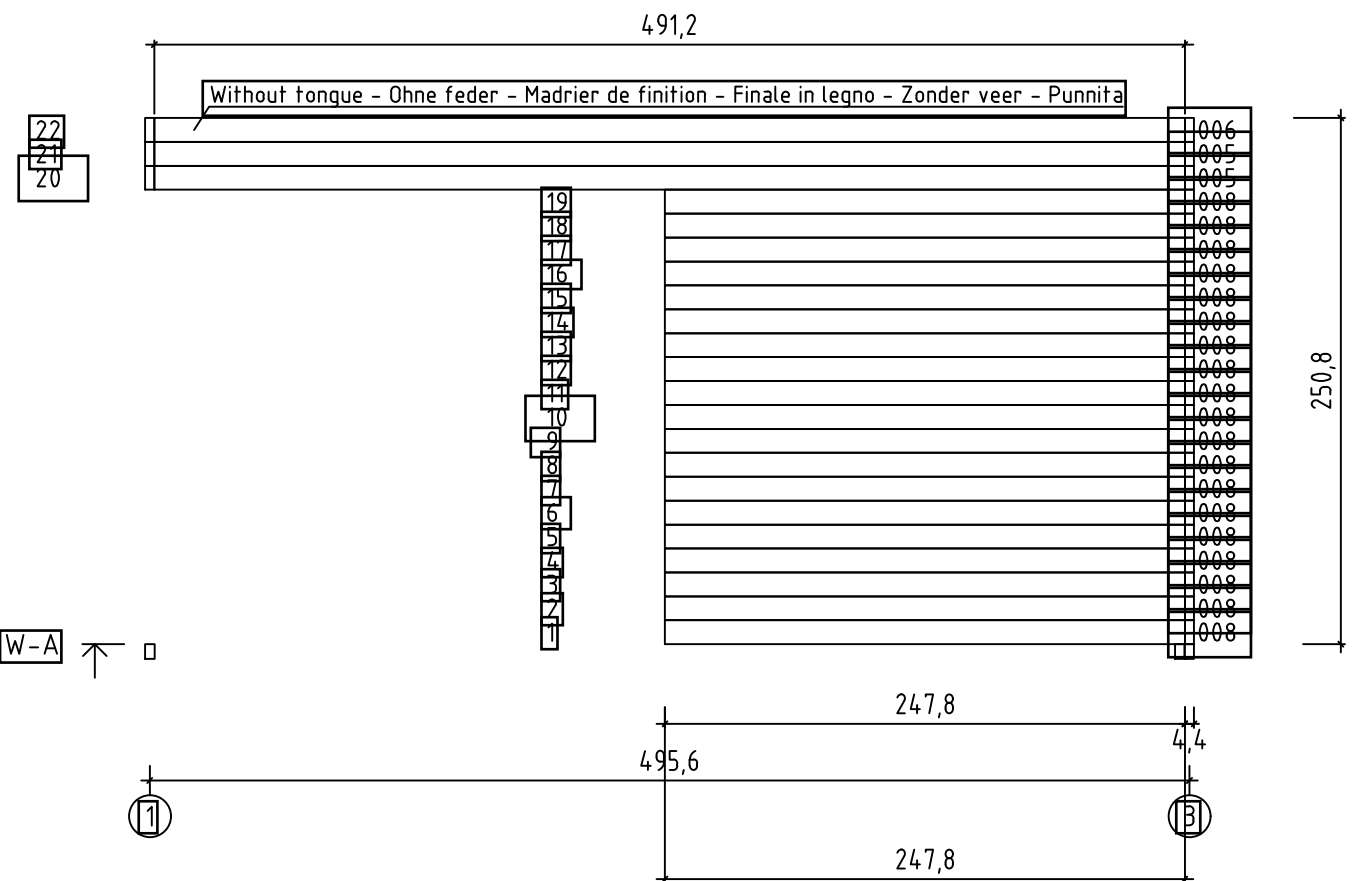
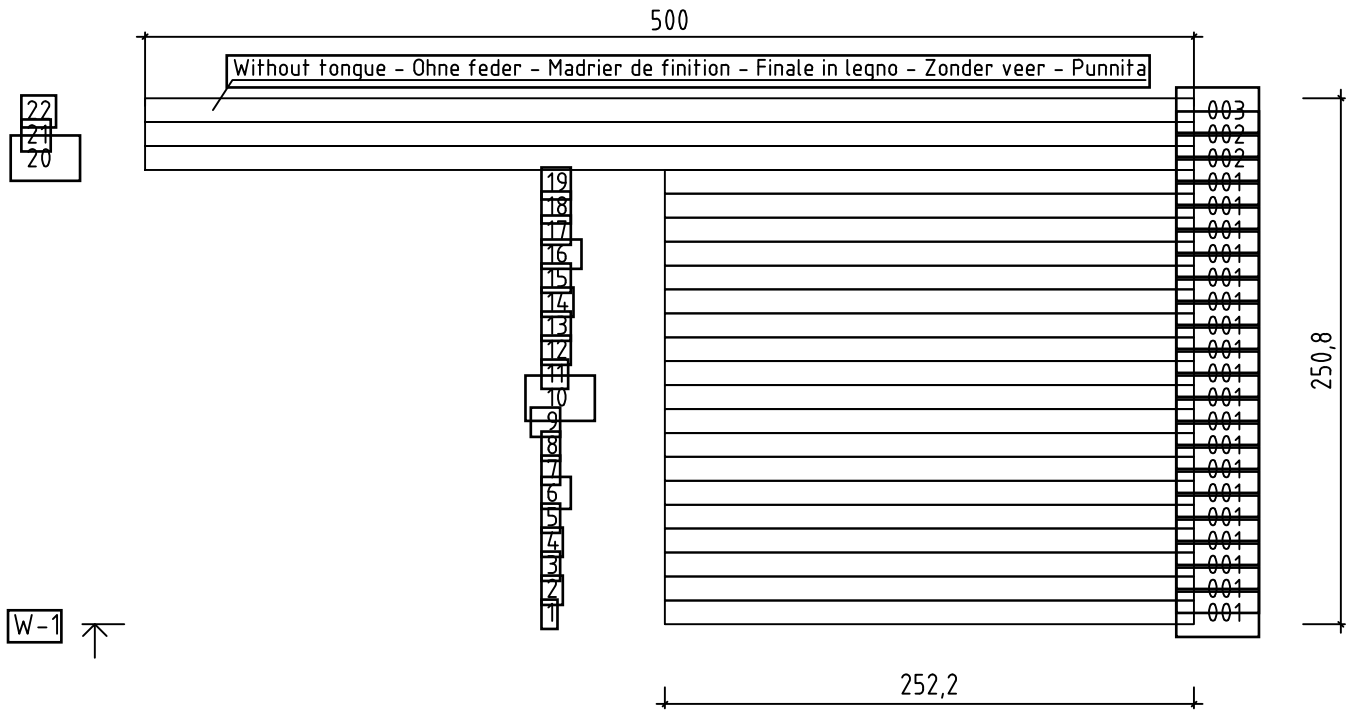

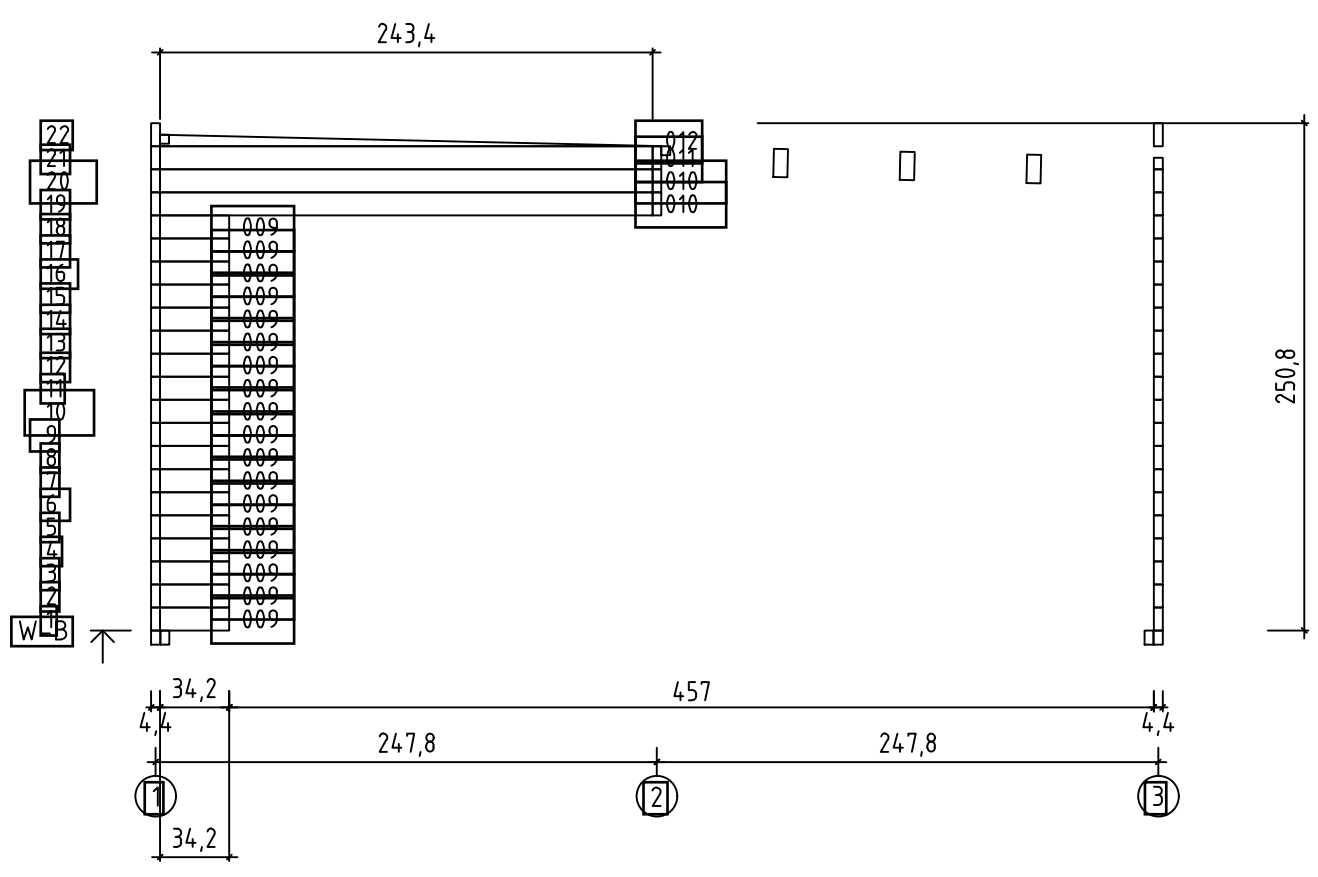
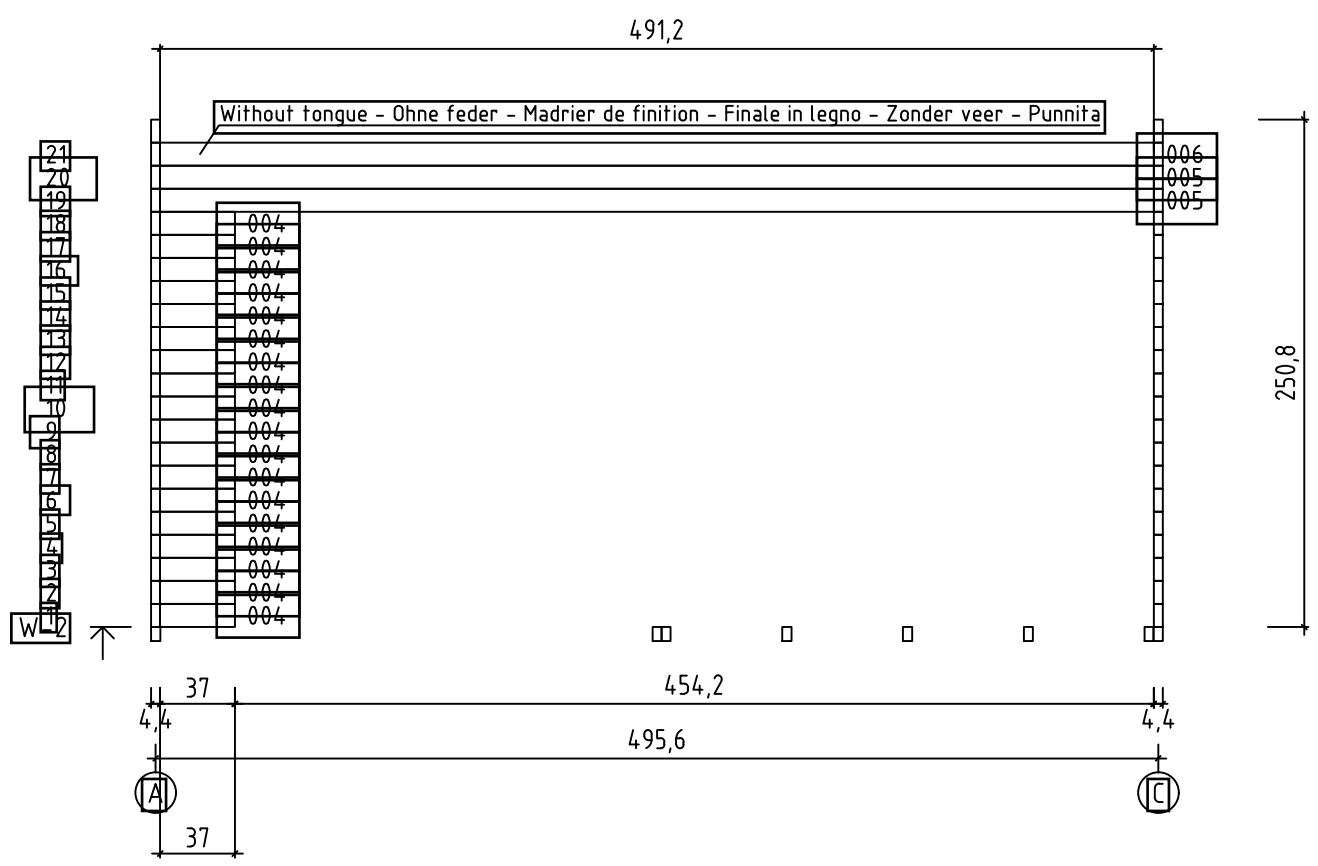

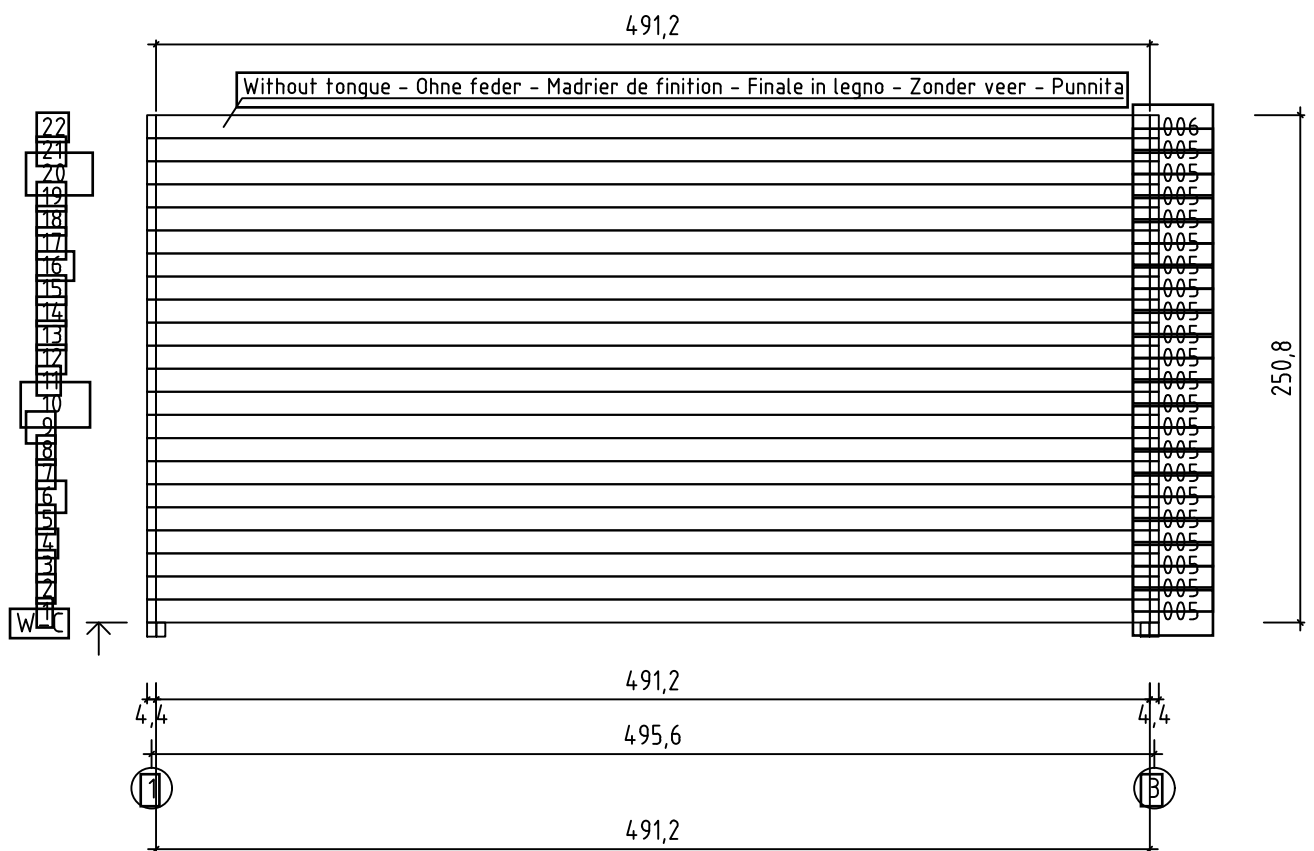

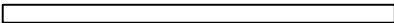

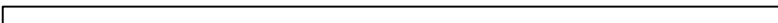

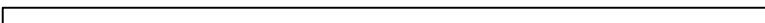
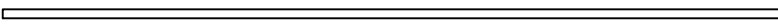
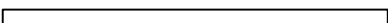

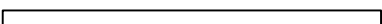
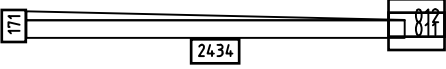
4/29

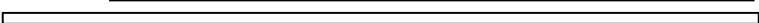
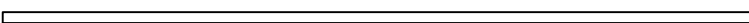

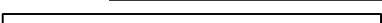
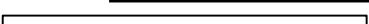

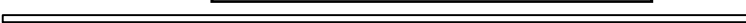

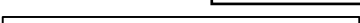
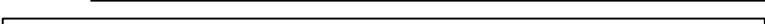



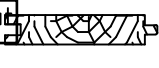



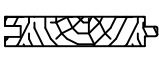























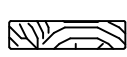
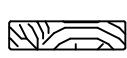













Pos	29.10.2020	Piece list - Stückliste - Liste des pièces - Elementi - Stuklijst - Tükítabel Art. Nr. 4426019	18/29	Q	P (mm)	L (mm)
001				19	44x114	2522
002				22	44x114	5000
003				2	44x114	5000
004				18	44x114	370
005				25	44x114	4912
006				3	44x114	4912
007				1	44x57	5000
008				19	44x114	2478
009				18	44x114	342
010				2	44x114	2434
WB-1				1		
IAR6		Foundation - Fundament - Fondation - Fondamenta - Fundering - Immutatud alusraam 		3	45x70	5000
IAR1		Foundation - Fundament - Fondation - Fondamenta - Fundering - Immutatud alusraam 		1	45x70	4865
IAR5		Foundation - Fundament - Fondation - Fondamenta - Fundering - Immutatud alusraam 		7	45x70	4820
IAR7		Foundation - Fundament - Fondation - Fondamenta - Fundering - Immutatud alusraam 		1	45x70	2522
IAR4		Foundation - Fundament - Fondation - Fondamenta - Fundering - Immutatud alusraam 		6	45x70	2433
IAR3		Foundation - Fundament - Fondation - Fondamenta - Fundering - Immutatud alusraam 		4	45x70	2342
IAR2		Foundation - Fundament - Fondation - Fondamenta - Fundering - Immutatud alusraam 		1	45x70	100
RV1		Lath - Pfetten - Liteau - Piccola asse - Gordingen - Roov 		1	44x44	4798
RV2		Lath - Pfetten - Liteau - Piccola asse - Gordingen - Roov 		1	44x44	2434
RV3		Lath - Pfetten - Liteau - Piccola asse - Gordingen - Roov 		1	44x44	2294
A-PR1		Roof beam - Dachbalken - Panne de toit - Perlina del tetto - Gordingen / dakbalk - Pärilin 		3	70x140	4904
A-PR2		Roof beam - Dachbalken - Panne de toit - Perlina del tetto - Gordingen / dakbalk - Pärilin 		6	70x140	2426

Pos	Piece list - Stückliste - Liste des pièces - Elementi - Stuklijst - Tükítabel Art. Nr. 4426019	9/29	Q	P (mm)	L (mm)
	Floor boards - Fussbodenbretter - Lame de plancher - Pavimento - Vloerhout - Pörändataud		27	90x18	4908
	Floor boards - Fussbodenbretter - Lame de plancher - Pavimento - Vloerhout - Pörändataud		28	90x18	2430
	Terrace boards - Terrassenbretter - Plancher de terrasse - Piattaforme ferrazzo - Terrasvtoer - Terrassitaud		27	90x19	2474
DB1	Roof boards - Dachbretter - Voliges - Perlina per tetto - Dakhout - Katusetaud		55	90x18	2571
DB2	Roof boards - Dachbretter - Voliges - Perlina per tetto - Dakhout - Katusetaud		55	90x18	2479
	Floor fillet - Fussbodenteiste - Corniere de finition du plancher - Finitura per pavimento (battisco pa) - Vloerafwerkljst - Pörändaliist			18x18	20
DPL1	Roofing felt fillet - Dachpappenleiste - Baguette de fixation du feutre bitumeux - Asse per fissaggio guaina bituminosa - Afdekljst asfaltpapier - Katussepapiliist		4	18x58	2569
DPL2	Roofing felt fillet - Dachpappenleiste - Baguette de fixation du feutre bitumeux - Asse per fissaggio guaina bituminosa - Afdekljst asfaltpapier - Katussepapiliist		2	18x58	2598
FL1	Fixing fillet - Fixierungsleiste - Profil de fixation - Massello di fissaggio - Bevestiging lijstwerk - Tendertiist		1	28x34	342
RS2	Railing strip - Begrenzungsleiste - Rembarde - Sbarra - Afscheidingslijst - Piirdetaud		2	18x70	1982
RS4	Railing strip - Begrenzungsleiste - Rembarde - Sbarra - Afscheidingslijst - Piirdetaud		2	18x70	2000
RS7	Railing strip - Begrenzungsleiste - Rembarde - Sbarra - Afscheidingslijst - Piirdetaud		2	18x90	2116
RS8	Railing strip - Begrenzungsleiste - Rembarde - Sbarra - Afscheidingslijst - Piirdetaud		2	18x90	2126
FL2	Post - Pfosten - Poteau - Piede registrabile - Stijl - Post		2	44x44	330
P1	Post - Pfosten - Poteau - Piede registrabile - Stijl - Post		2	70x70	2337
P2	Post - Pfosten - Poteau - Piede registrabile - Stijl - Post		1	70x70	2394
P3	Post - Pfosten - Poteau - Piede registrabile - Stijl - Post		2	70x70	2452
P4	Post - Pfosten - Poteau - Piede registrabile - Stijl - Post		1	90x90	2052
P5	Post - Pfosten - Poteau - Piede registrabile - Stijl - Post		1	90x90	2360
DRV1	Roof edge reinforcement - Dachrandverstärkung - Corniere de renfort de bord de toit - Rinforzo x tetto - Dakrand versterking - Räästatugevdus		4	80x44	2500
DRV2	Roof edge reinforcement - Dachrandverstärkung - Corniere de renfort de bord de toit - Rinforzo x tetto - Dakrand versterking - Räästatugevdus		4	80x44	2580
FF2	Fixing fillet - Fixierungsleiste - Profil de fixation - Massello di fissaggio - Bevestiging lijstwerk - Tendertiist		2	15x45	2026
FF	Fixing fillet - Fixierungsleiste - Profil de fixation - Massello di fissaggio - Bevestiging lijstwerk - Tendertiist		2	18x44	2030



Pos	29.10.2020	Piece list - Stückliste - Liste des pièces - Elementi - Stuklijst - Tükítabel Art. Nr. 4426019	10/29	Q	P (mm)	L (mm)
FF3		Fixing fillet - Fixierungsleiste - Profil de fixation - Massello di fissaggio - Bevestiging lijstwerk - Tenderliist		2	38x46	1980
FF4		Fixing fillet - Fixierungsleiste - Profil de fixation - Massello di fissaggio - Bevestiging lijstwerk - Tenderliist		2	38x46	2026
GL1		Gable moulding - Giebelleiste - Planche de rive - Finitura per frontale e retro del tetto - Geveltijst - Viitulaud		4	18x120	2580
GL2		Gable moulding - Giebelleiste - Planche de rive - Finitura per frontale e retro del tetto - Geveltijst - Viitulaud		4	18x120	2598
		Fascia sheet - Abschlussprofil - Profil de finition métallique pour débord de toiture - Scossalina di protezione dall'acqua per bordo di tegno - Afdek profiet / boordprofiet - Räästaplekk		8		2650
HS34		Screw for wall details - Schraube für wand details - Vis pour mur details - Viti per elementi della porta - Schroef voor wand details - Krugi seinte montaaziks		500	5x80	
HS10		Screw for door jamb - Schraube für türrahmen - Vis de fixation partie haute avec montants du cadre de porte - Viti x fissaggio montanti porte - Schroef voor deurkozijn - Krugi ukse lengite		8	4x25	
HS12		Screw for doorstep - Schrauben für swelle - Vis pour fixation barre de seuil - Vite per soglia della porta - Schroef voor deurdorpel - Krugi lävepakute		6	4x40	
HS12		Screw for metal corner - Holzschraube für metallwinkel - Vis de fixation des cornieres en métal - Viti per fissare suadretta di metallo di giunzione - Schroef voor metalen hoek - Krugi nurgikute		20	4x40	
HS12		Screw for covering moulding - Schrauben für deckungsprofil - Vis de fixation profils horizontaux haut intérieur et extérieur d'encadrement de porte - Vite per cornice di copertura - Schroef voor afdekprofiet - Krugi piirdetaute		32	4x40	
HS12		Screw for beam holder - Schrauben für balkenhalter - Vis de fixation support "u" galvanisé - Vite per trave di sostegno - Schroef voor bevestiging balkhouder (gordingschoen) - Krugi tatakigute		216	4x40	
HS12		Screw for fixing fillet of door and window - Schrauben für fixierungsleiste - Vis pour profil vertical de fixation pour ouvertures des fenetres et portes - Viti per massello di fissaggio - Schroeven voor bevestiging van deur en raam lijsten - Krugi tenderliistudele		36	4x40	
HS12		Screw for door jamb - Schraube für türrahmen - Vis de fixation partie haute avec montants du cadre de porte - Viti x fissaggio montanti porte - Schroef voor deurkozijn - Krugi ukse lengite		12	4x40	
HS12		Screw for gable moulding - Schrauben für giebelleiste - Vis pour fixation planche de rive - Vite per fissare finitura davanti e dietro del tetto - Schroef voor geveltijst - Krugi viitulaute		48	4x40	
HS13		Screw for wall details - Schraube für wand details - Vis pour mur details - Viti per elementi della porta - Schroef voor wand details - Krugi seinadetailite		12	4x60	
HS33		Screw for door jamb - Schraube für türrahmen - Vis de fixation partie haute avec montants du cadre de porte - Viti x fissaggio montanti porte - Schroef voor deurkozijn - Krugi ukse lengite		16	5x40	
HS16		Screw for foundation - Schrauben zur befestigung fundament - Vis de fixations des poutrelles de fondations - Viti x fundamenta - Schroef voor fundering - Krugi alusraamite		60	5x90	
HS16		Screw for post - Schrauben für pfosten - Vis de fixation des poteaux - Viti per inviare - Schroef voor stijlen - Krugi postite		12	5x90	
HS16		Screw for roof edge reinforcement - Schrauben für dachrandverstärkung - Vis pour fixation corniere renfort de bord de toit - Viti x rinforzo bordo tetto - Schroef voor dakrand versterking - Krugi räästatugevdusele		40	5x90	
HS16		Screw for door jamb - Schraube für türrahmen - Vis de fixation partie haute avec montants du cadre de porte - Viti x fissaggio montanti porte - Schroef voor deurkozijn - Krugi ukse lengite		10	5x90	
HS27		Screw for post - Schrauben für pfosten - Vis de fixation des poteaux - Viti per inviare - Schroef voor stijlen - Krugi postite		8	6x120	
HS22		Screw for 1. wall beam - Schraube für 1. bohlenreihe - Vis de fixations 1ere rangée de madriers avec poutrelles de fondations - Vite fissaggio alle fondamenta - Schroef voor 1 wandbalk - Krugi poolltaute		12	6x150	
HS23		Screw for wall details - Schraube für wand details - Vis pour mur details - Viti per elementi della porta - Schroef voor wand details - Krugi seinadetailidete		260	6x180	



Art. Nr. 4426019

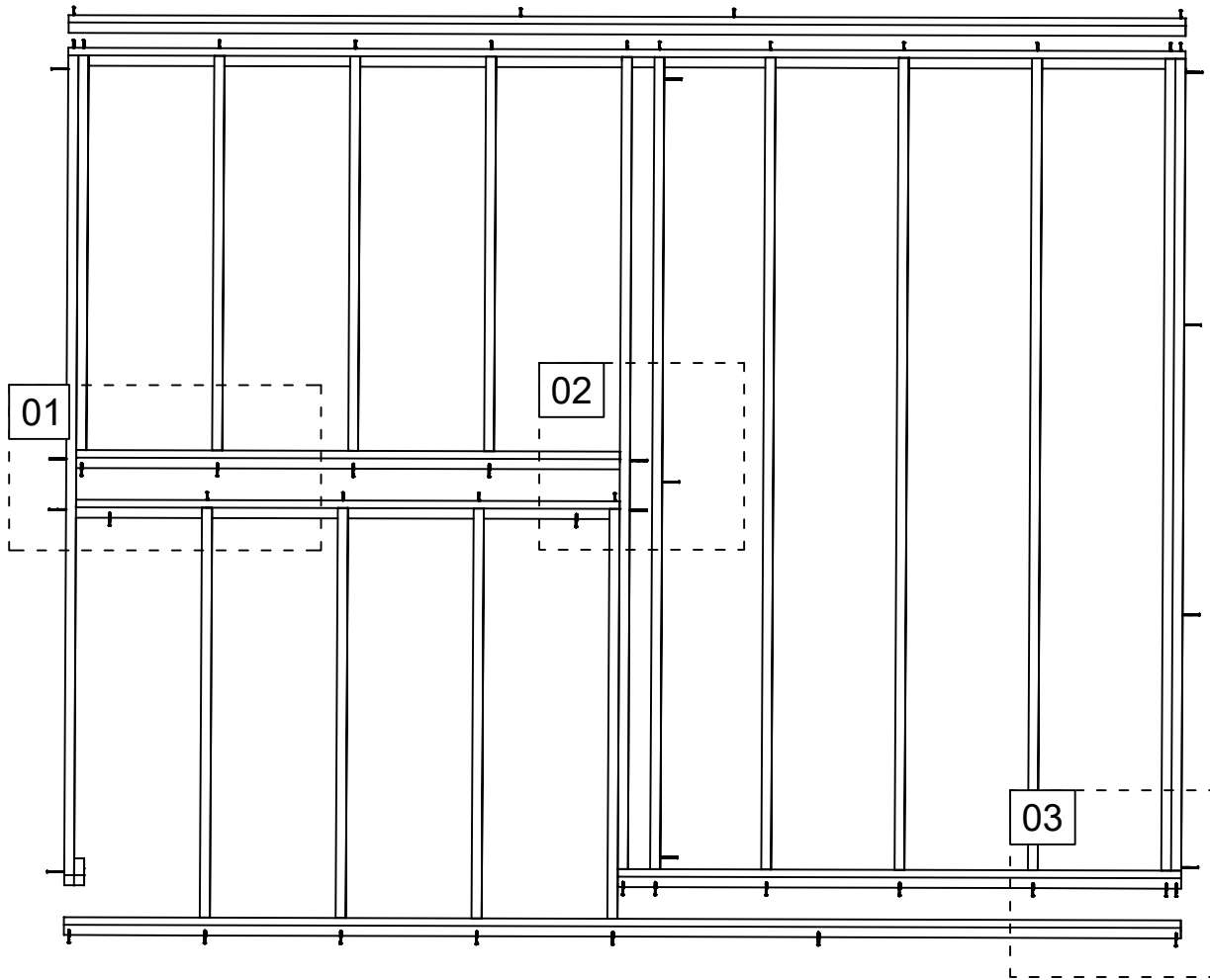

29.10.2020

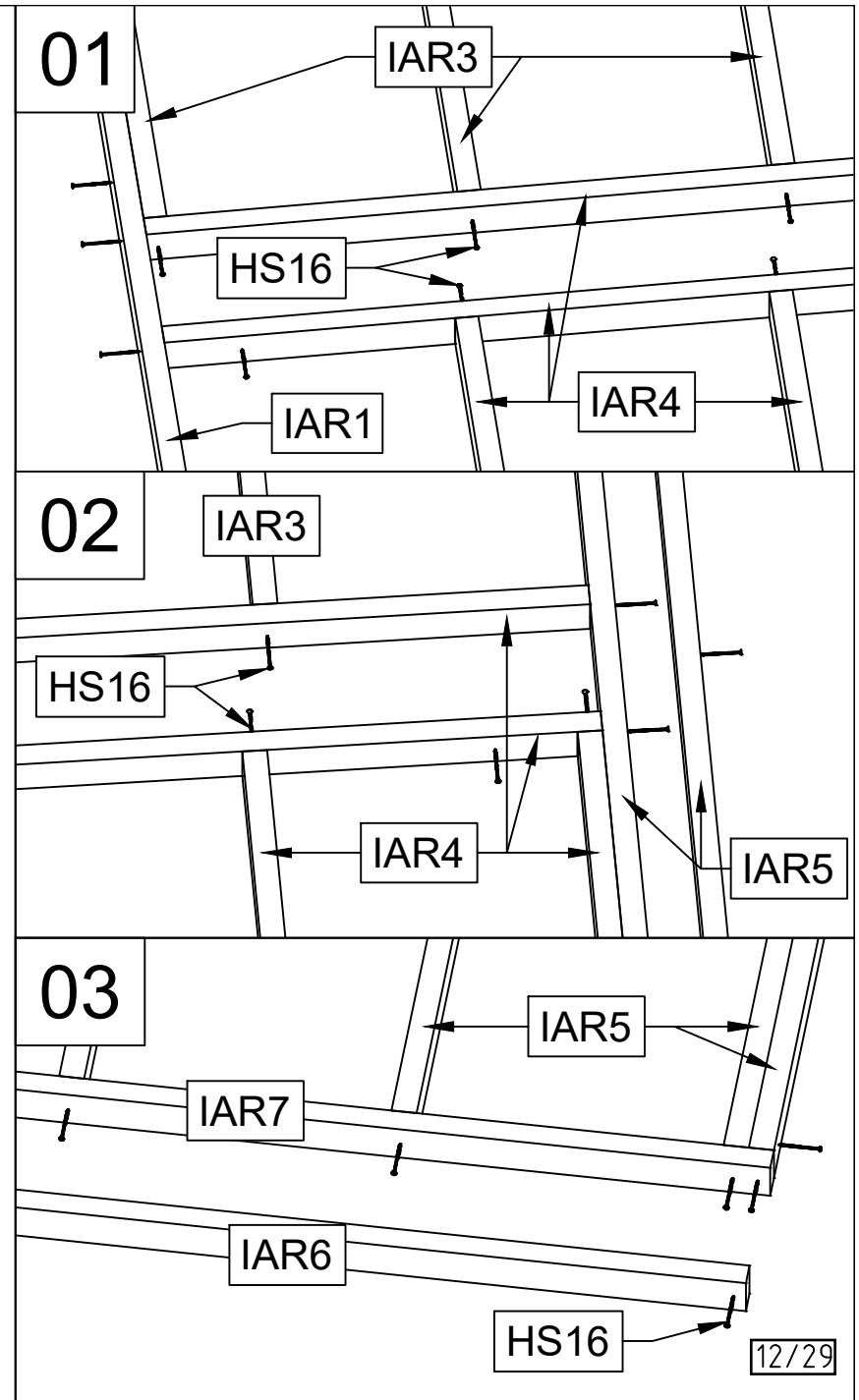

Art. Nr. 4426019

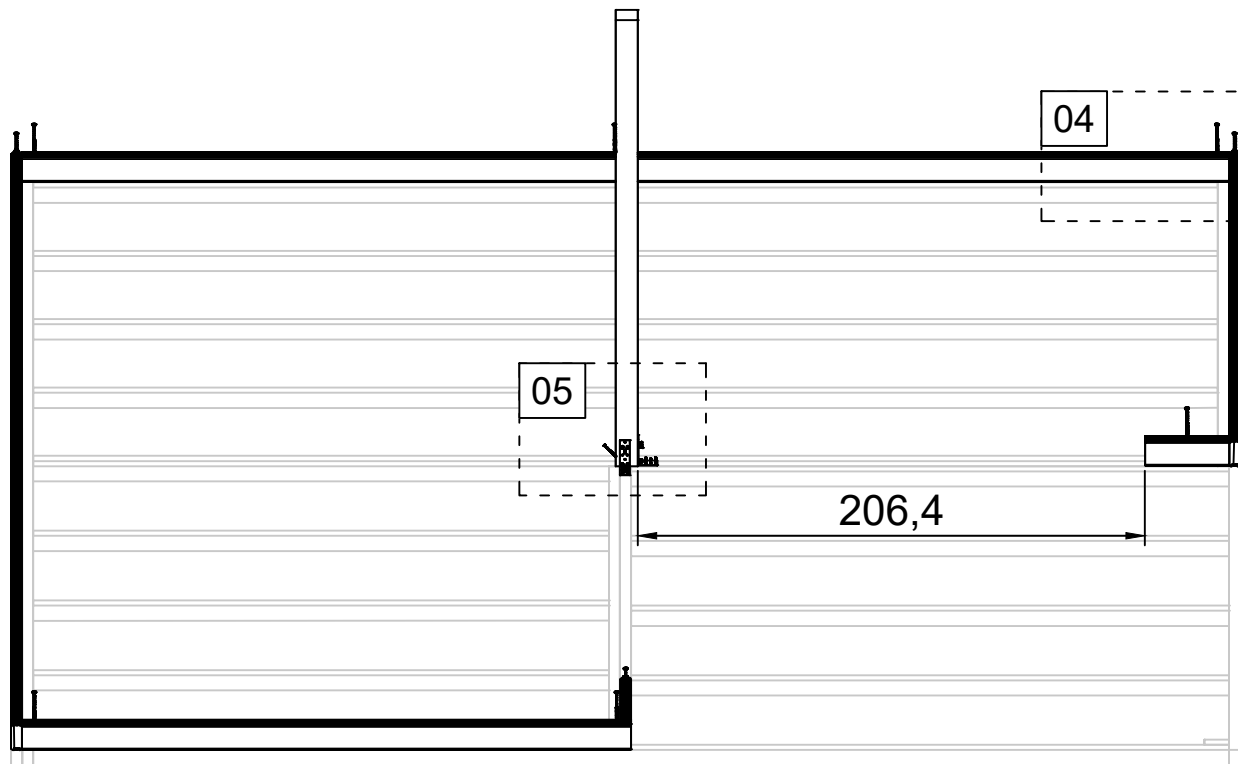

04

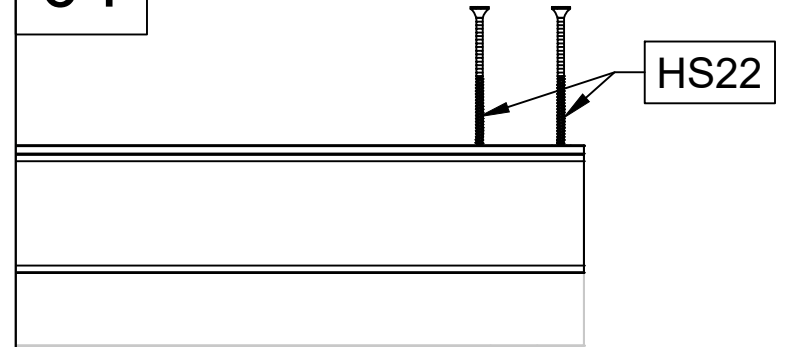

05

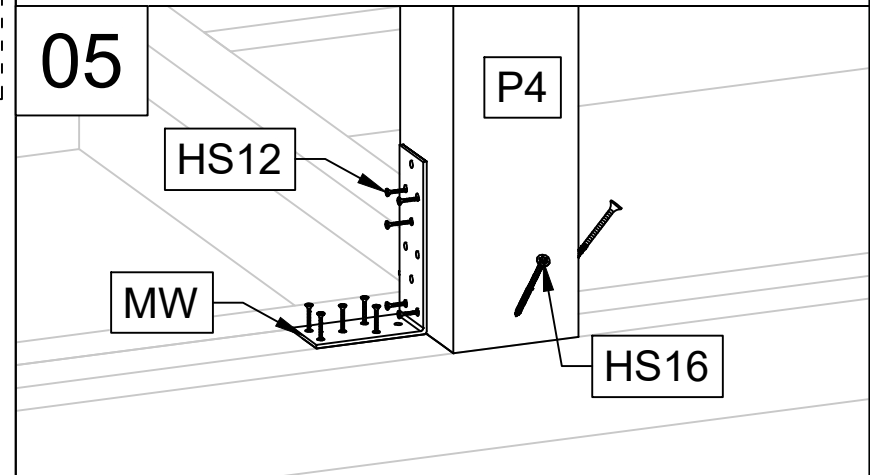

05

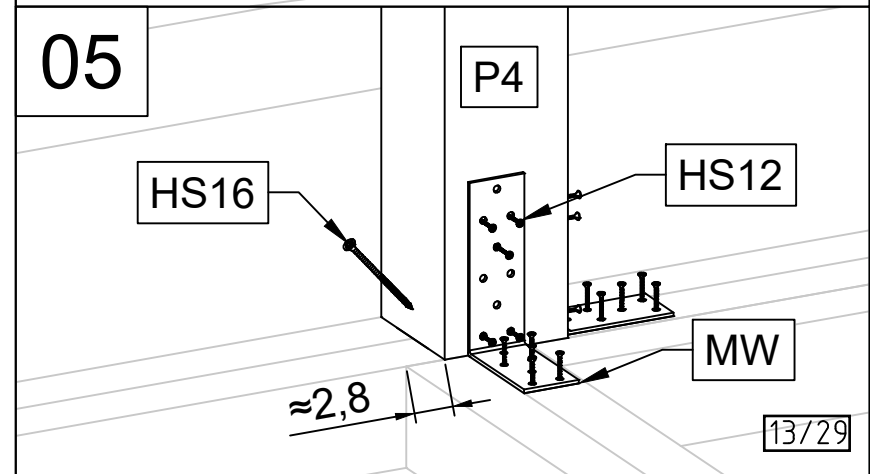

29.10.2020

13/29

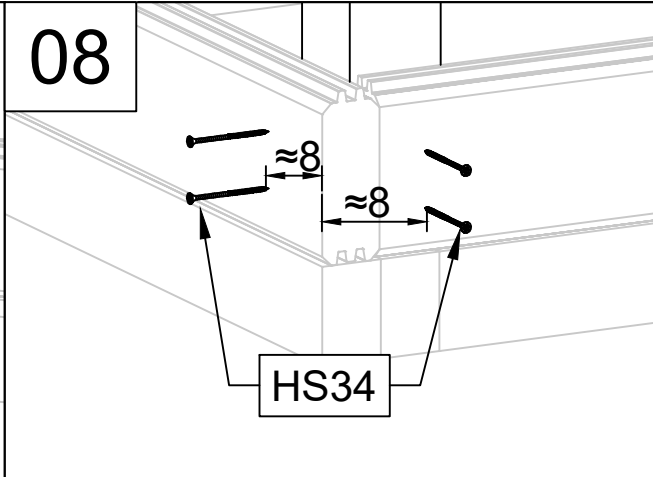
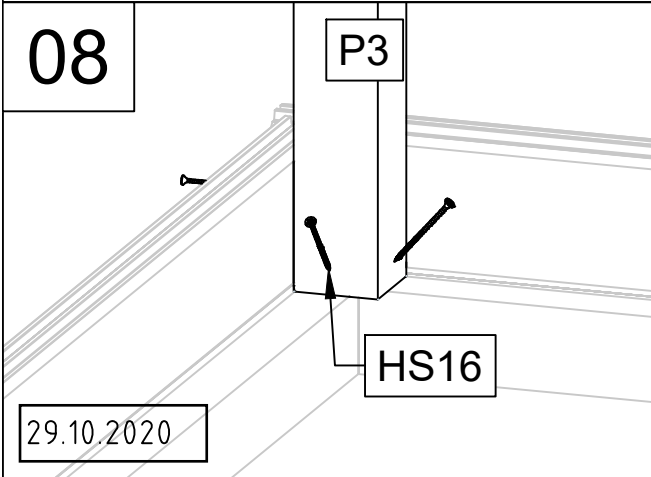
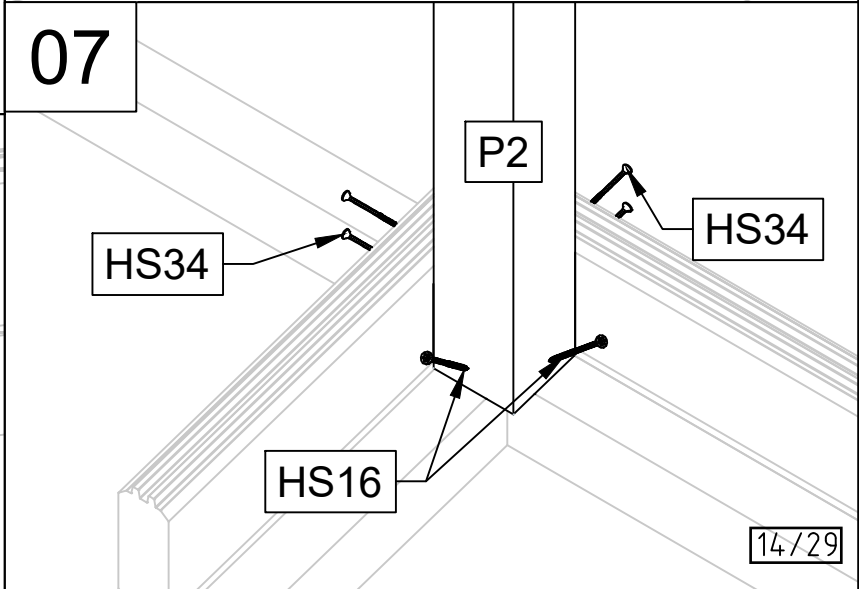
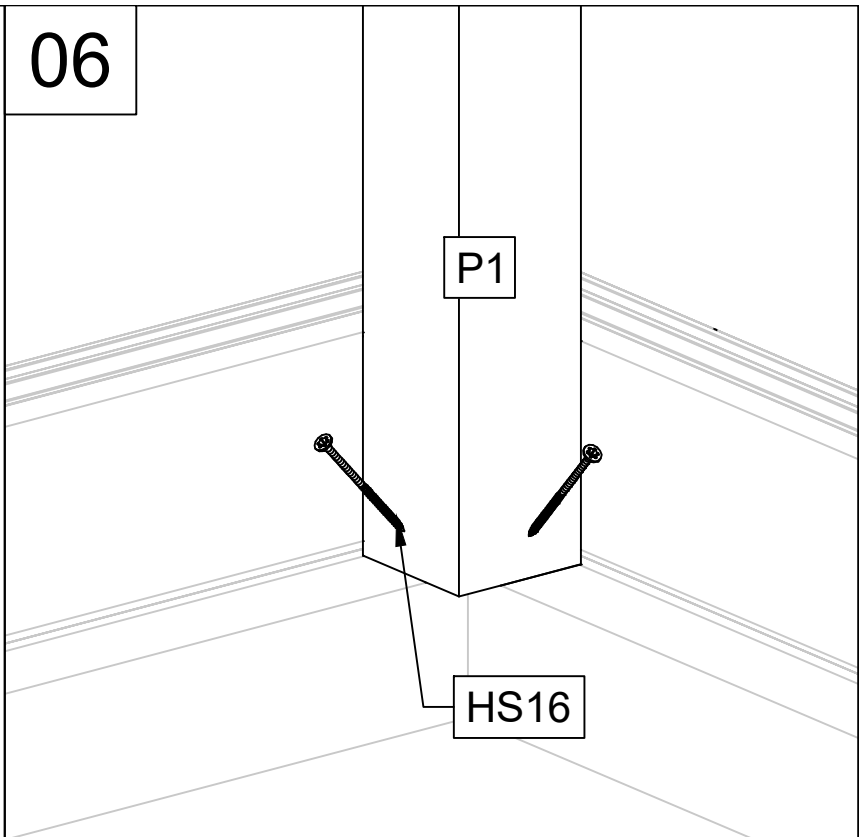
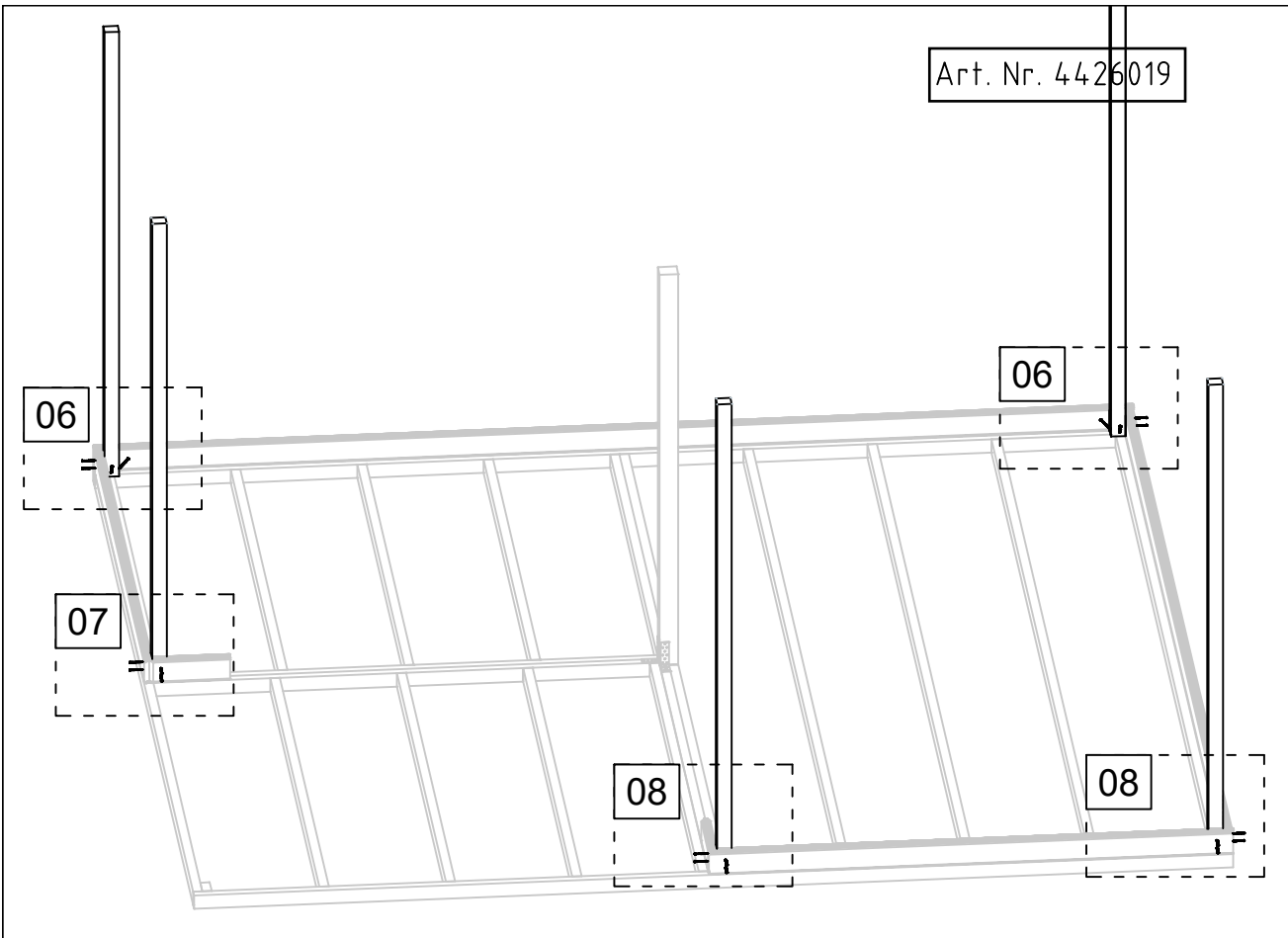

29.10.2020



Art. Nr. 4426019

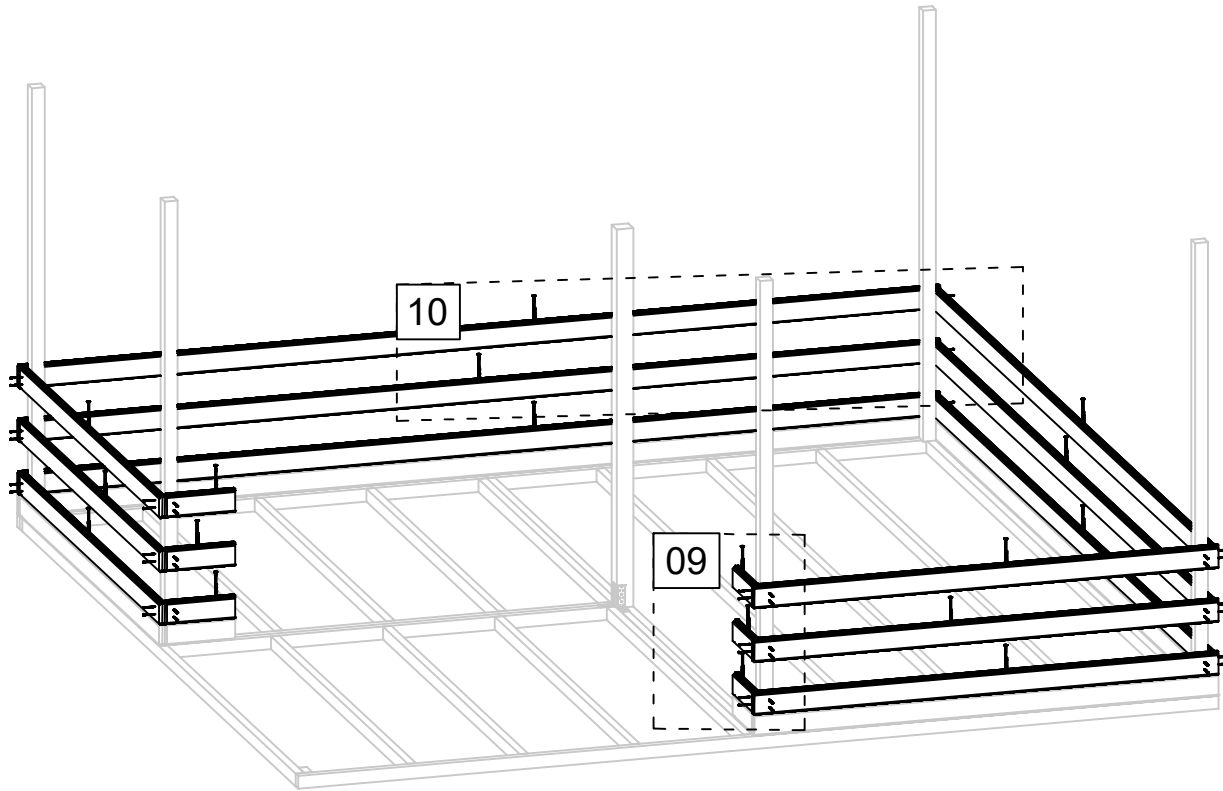

29.10.2020

09

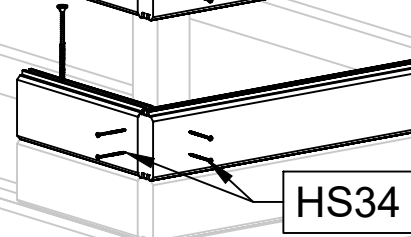
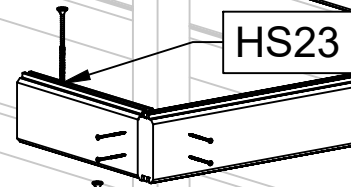

10

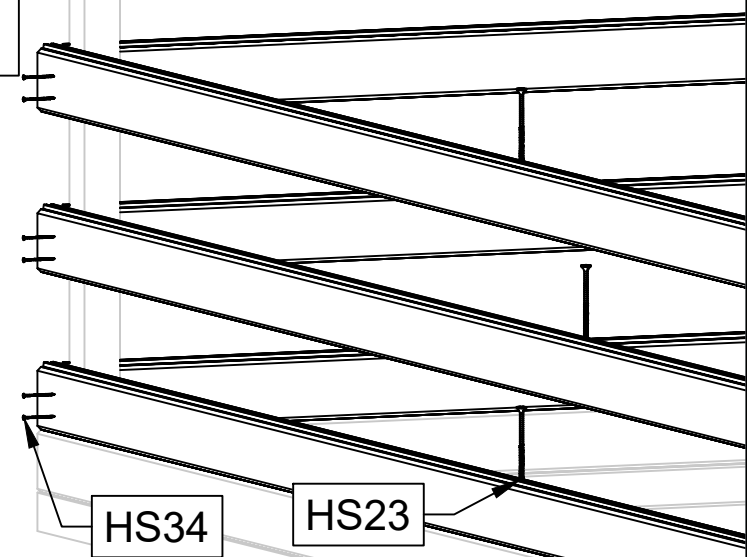

HS23

15/29

Art. Nr. 4426019

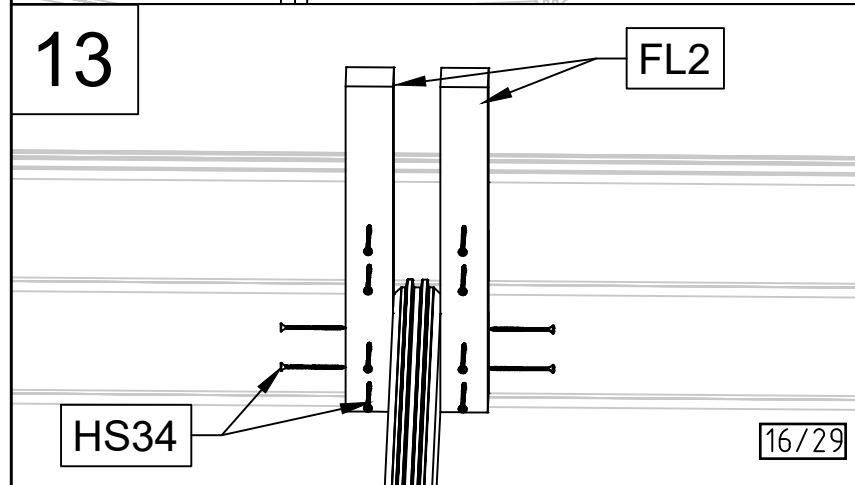
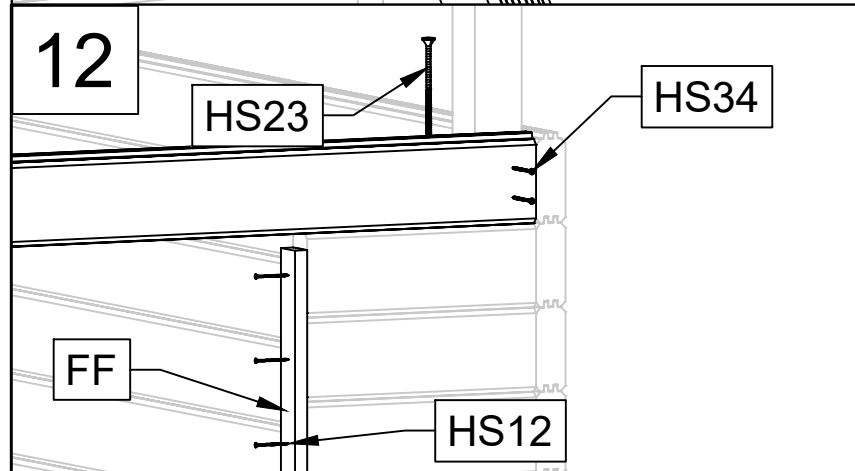
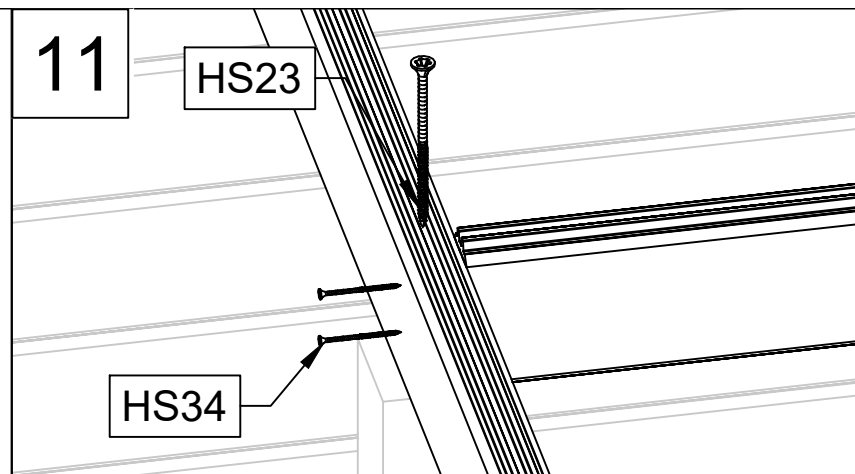
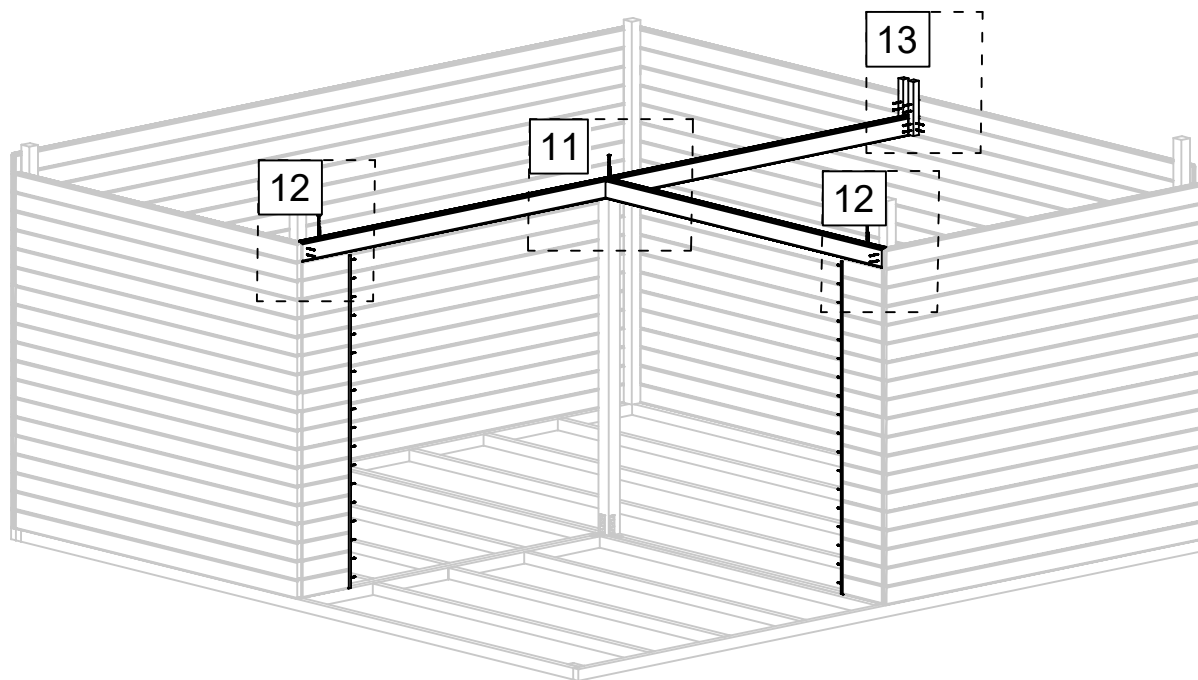

29.10.2020

Art. Nr. 4426019

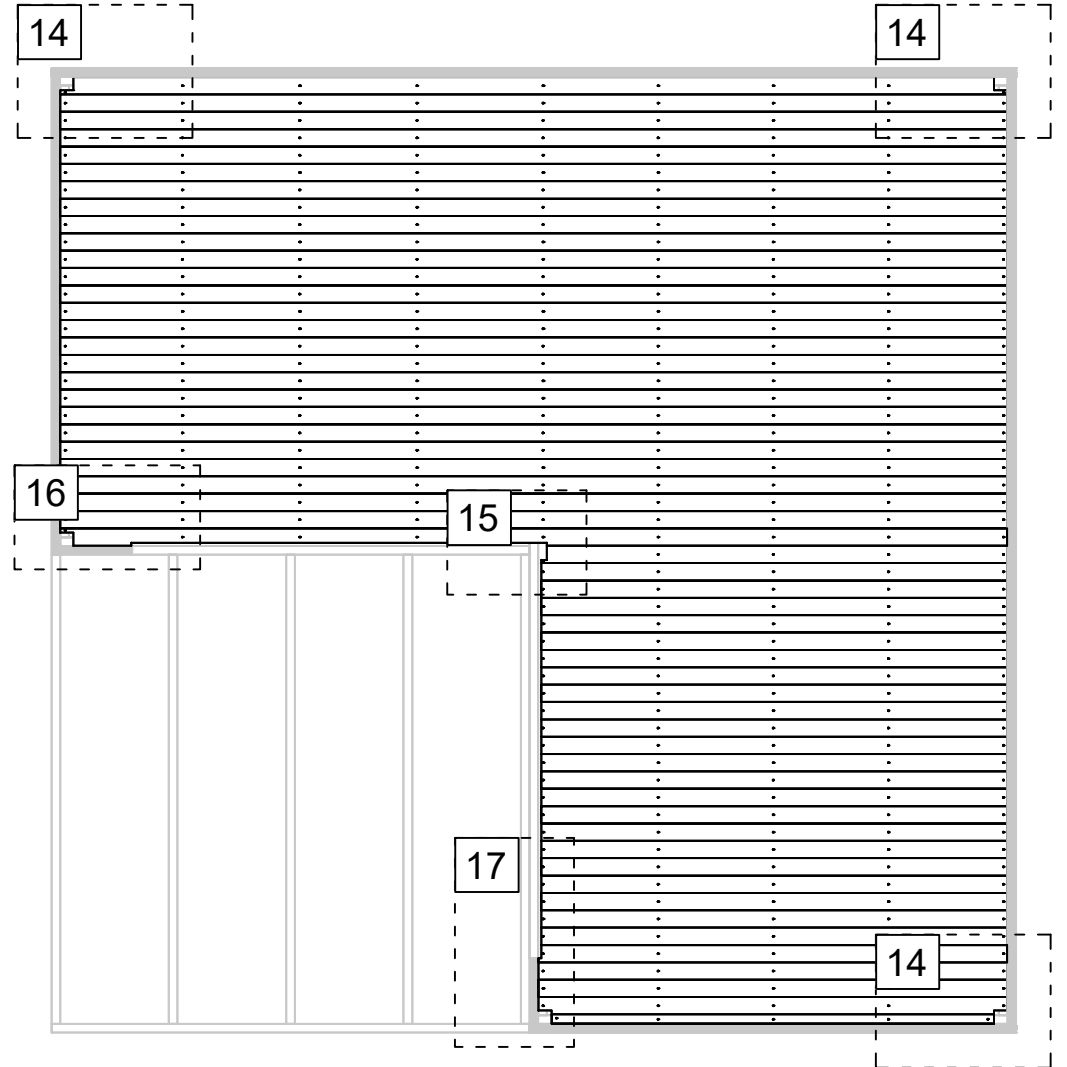
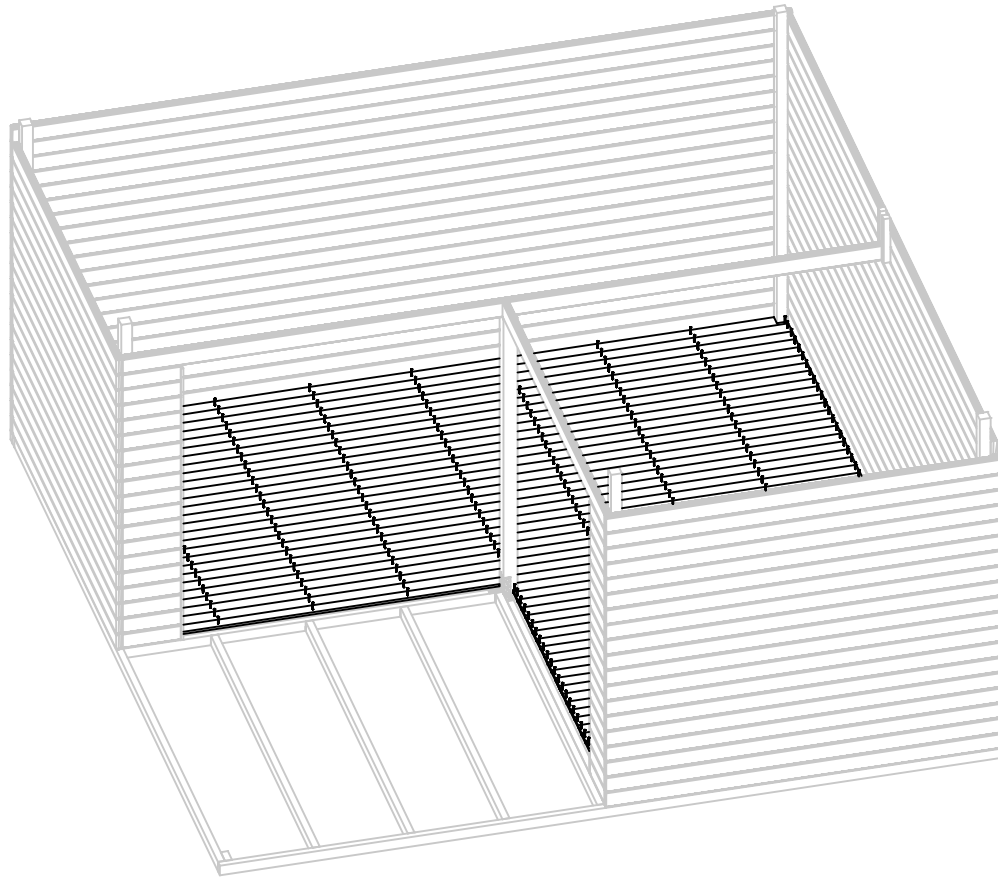

29.10.2020

17/29

14

Art. Nr. 4426019

15

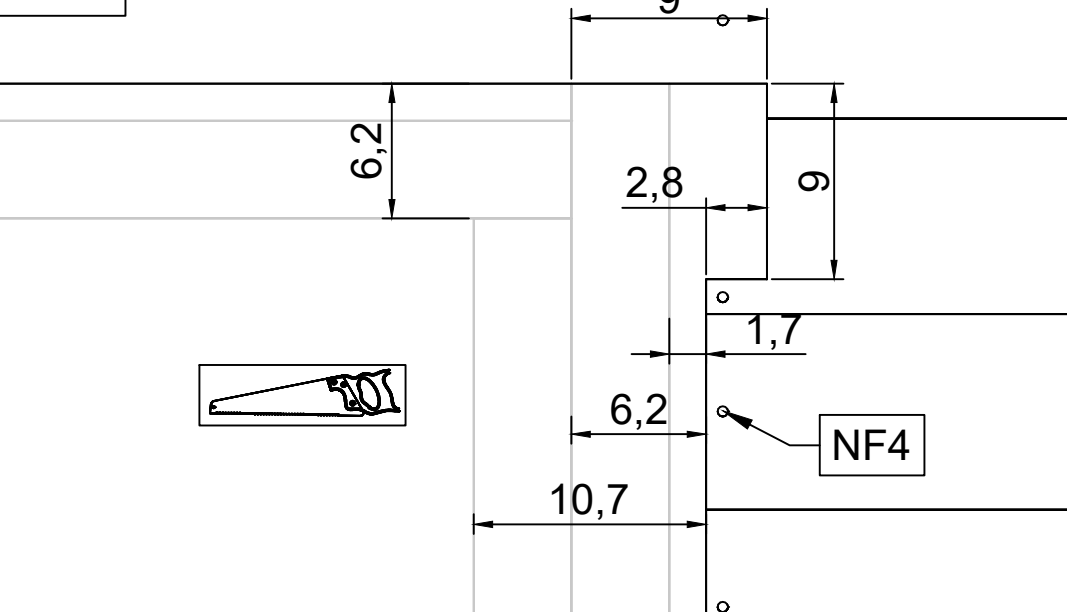
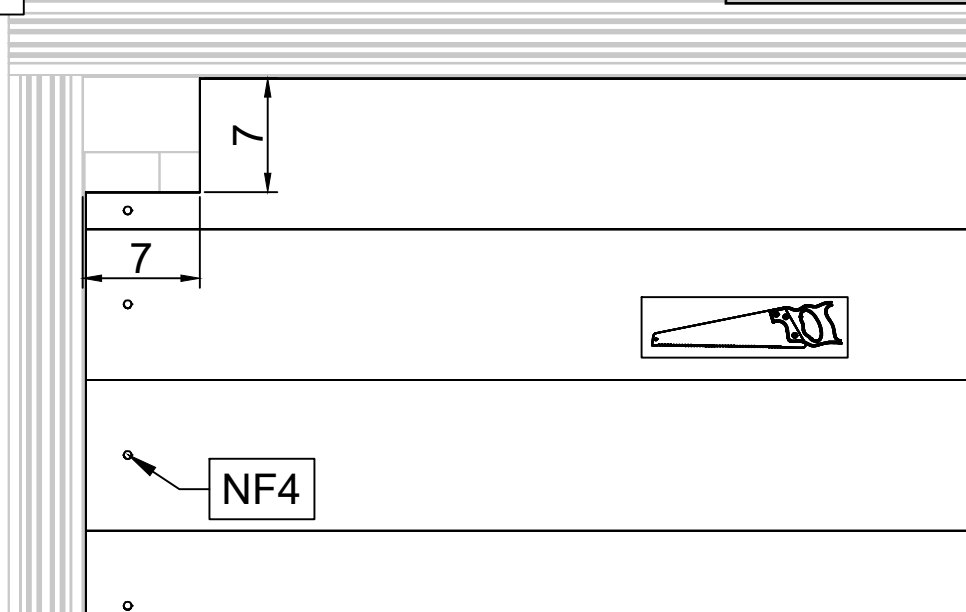

16

17

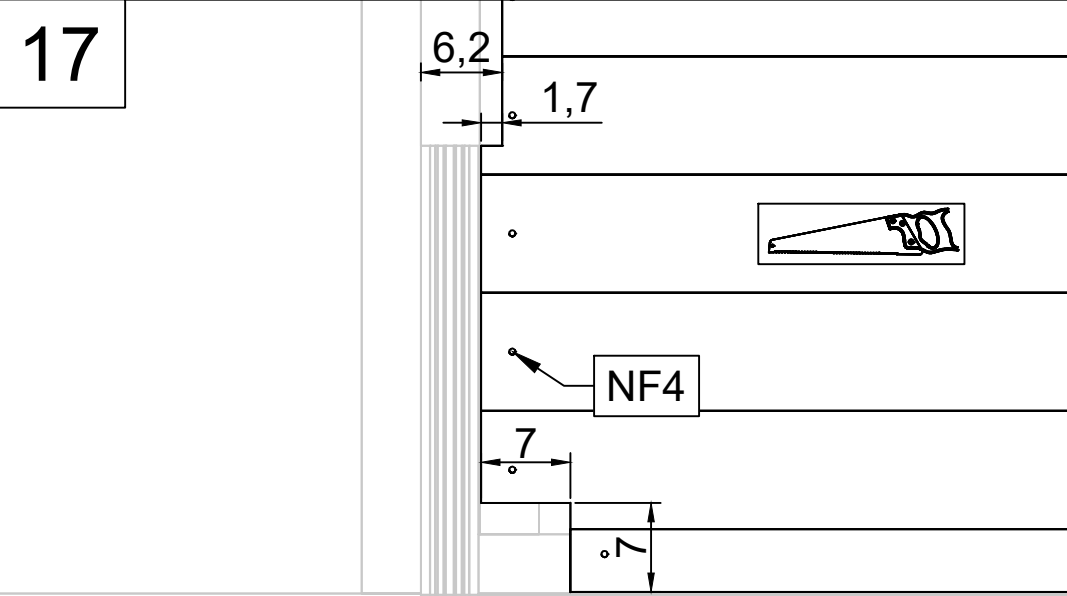
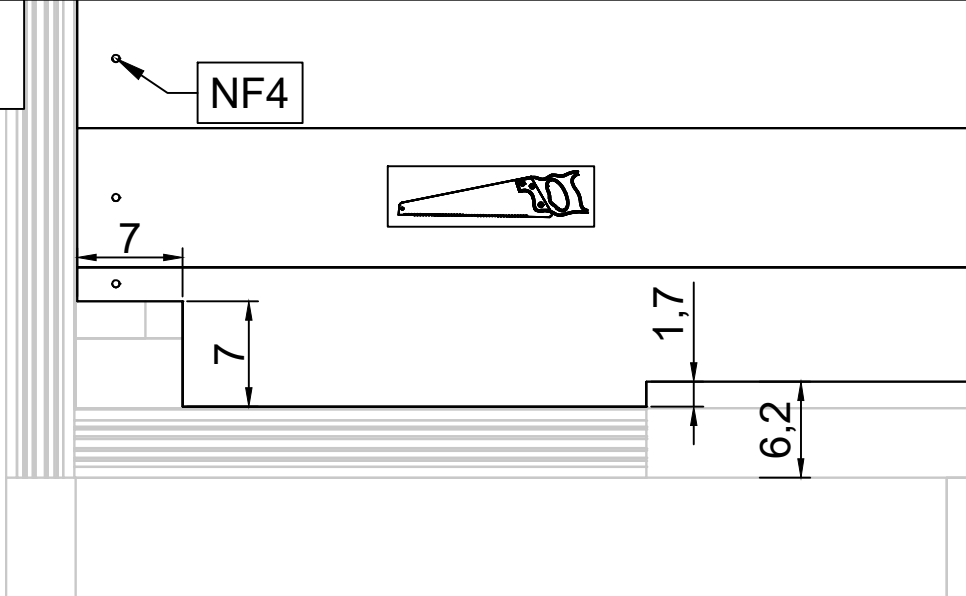

Art. Nr. 4426019

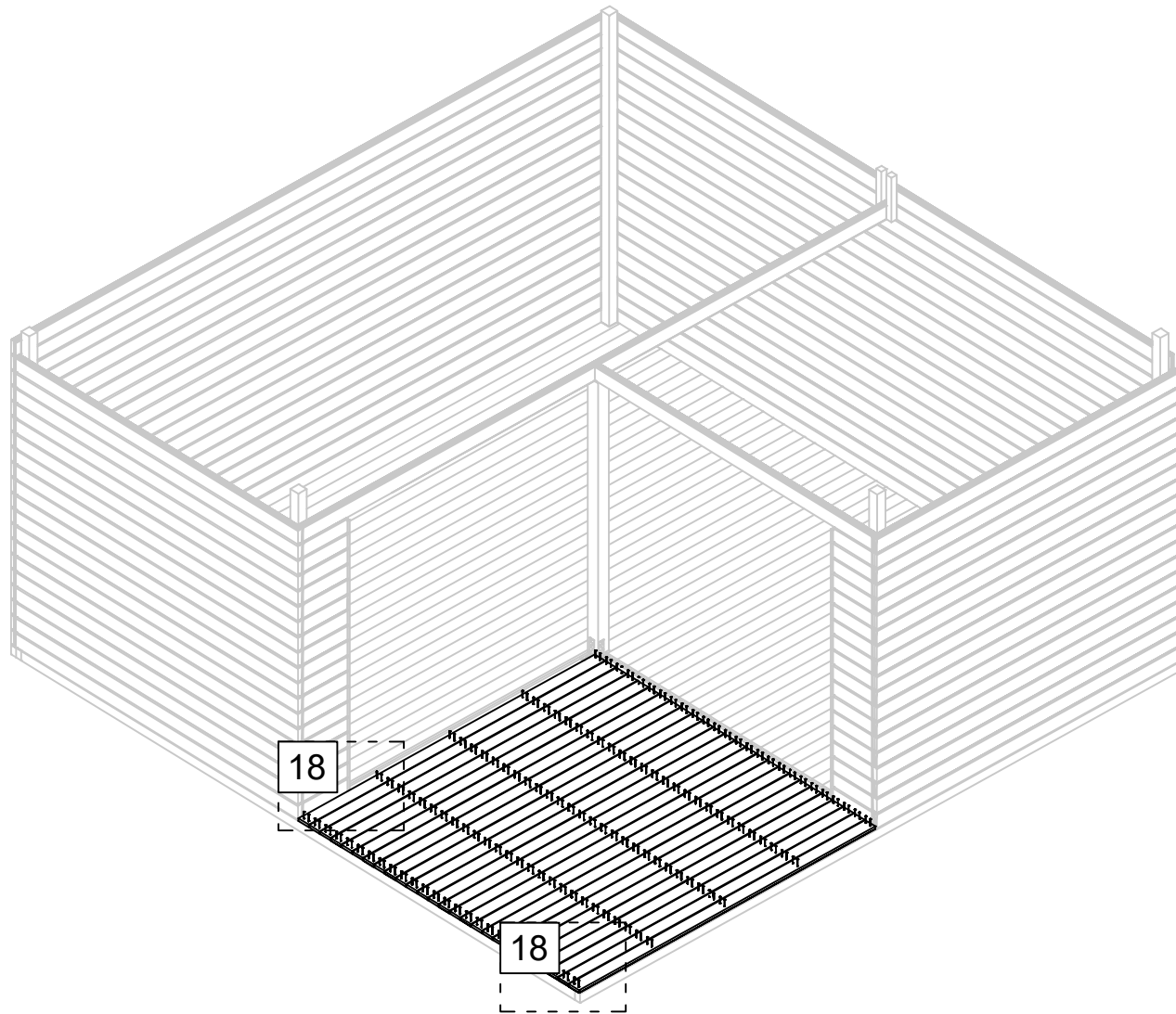

29.10.2020

18

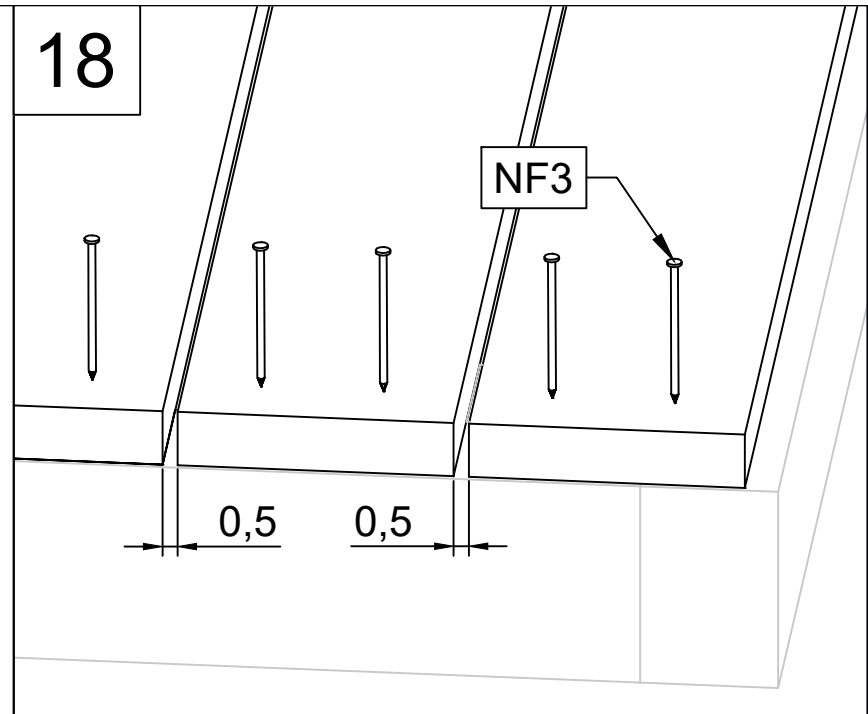

18

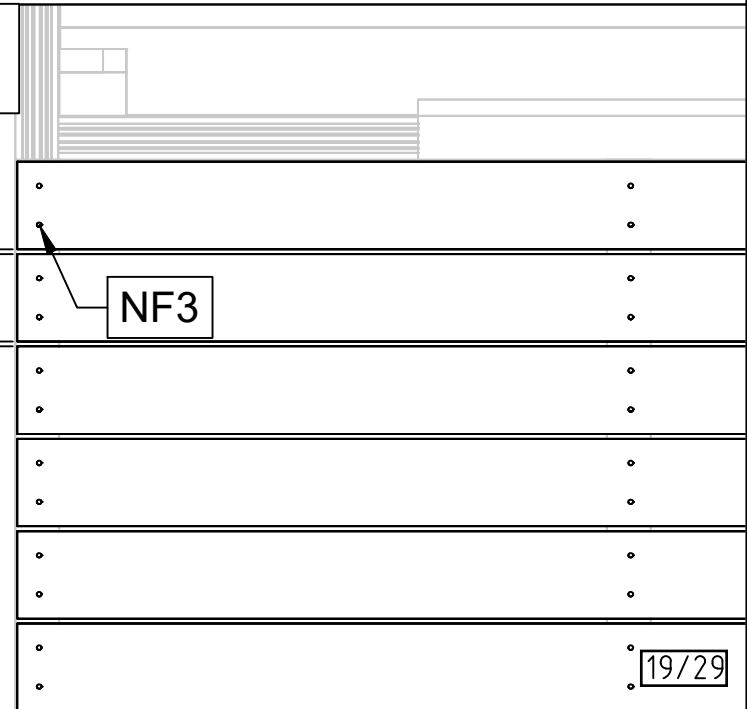

19/29



Art. Nr. 4426019

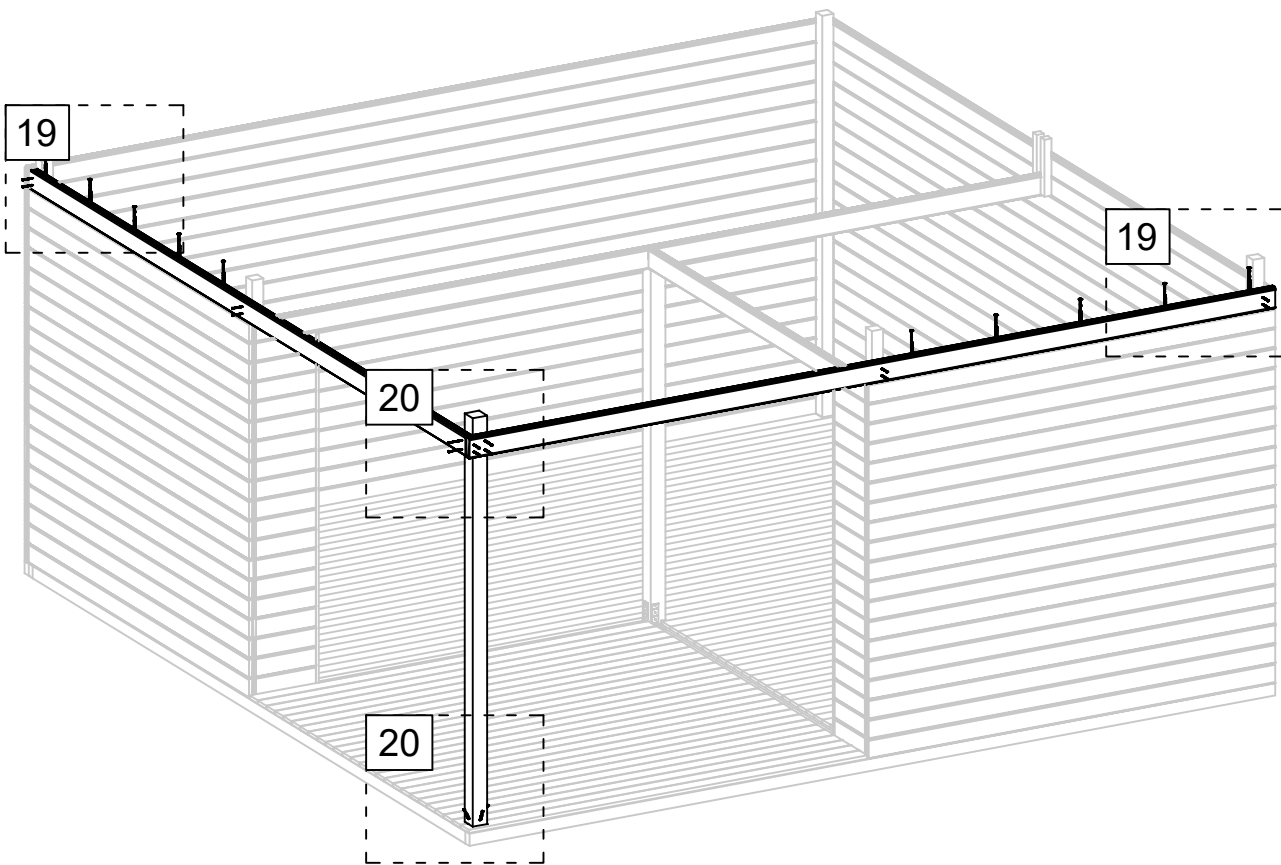

29.10.2020

19

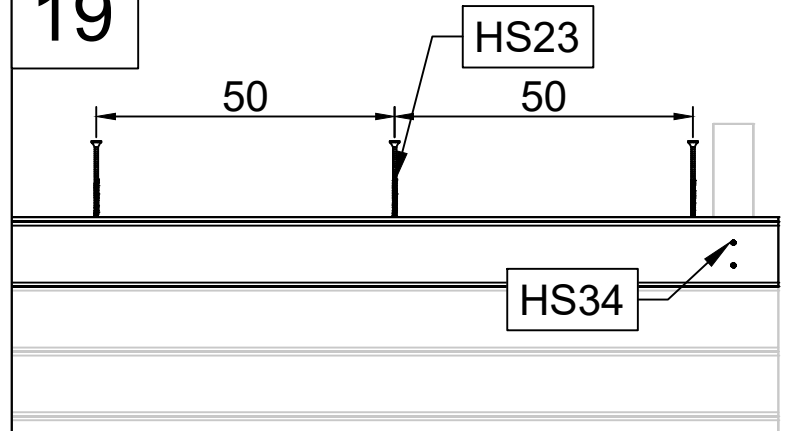

20

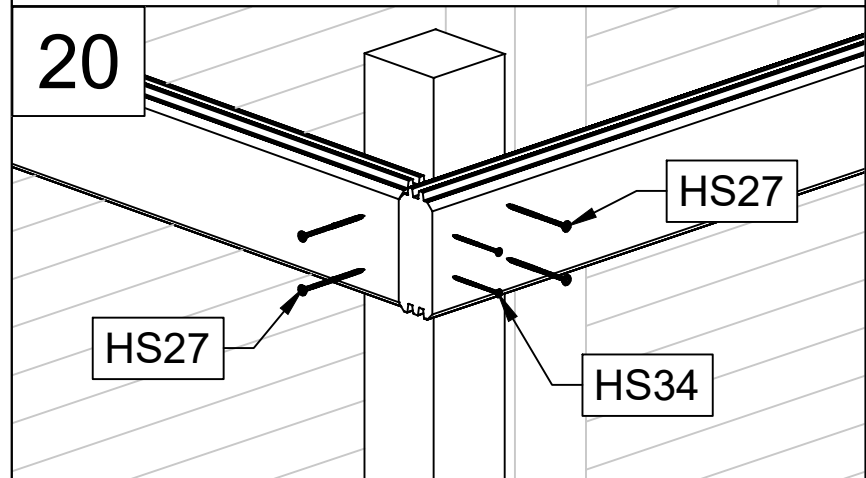

20

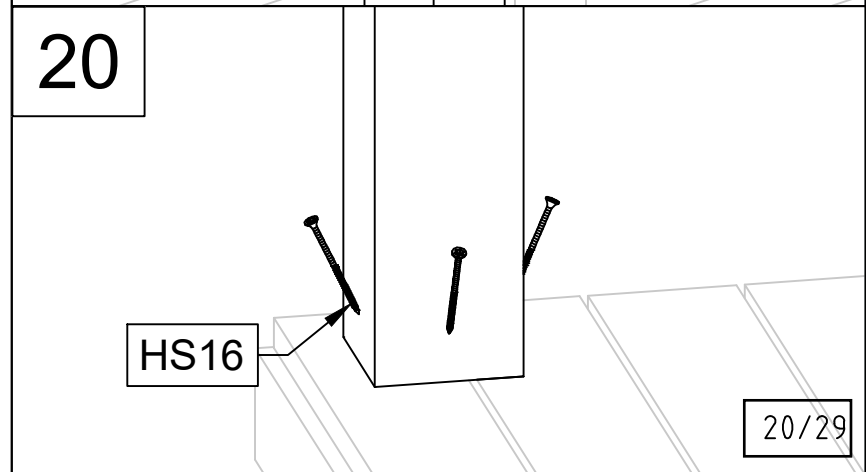

20/29

Art. Nr. 4426019

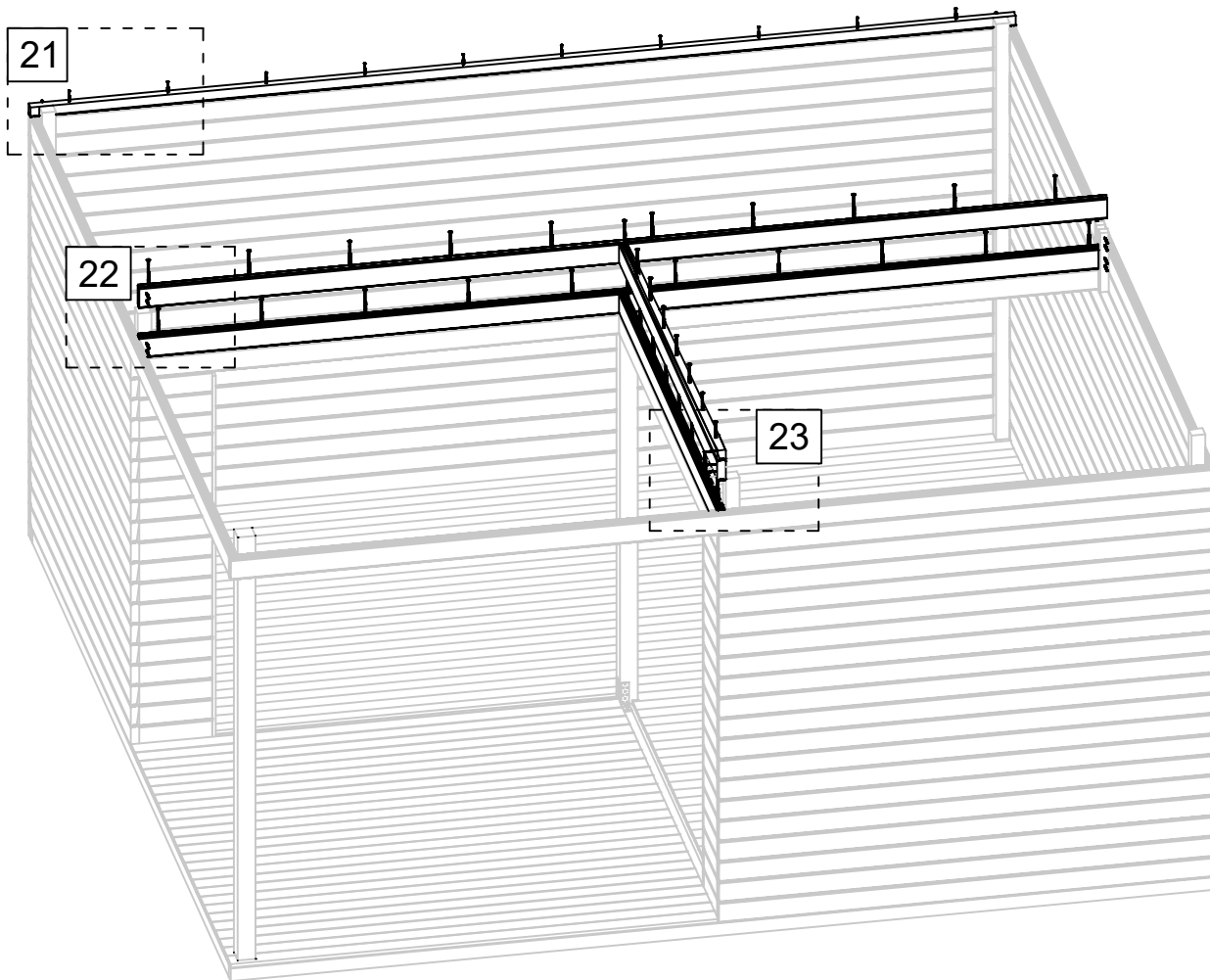

29.10.2020

21

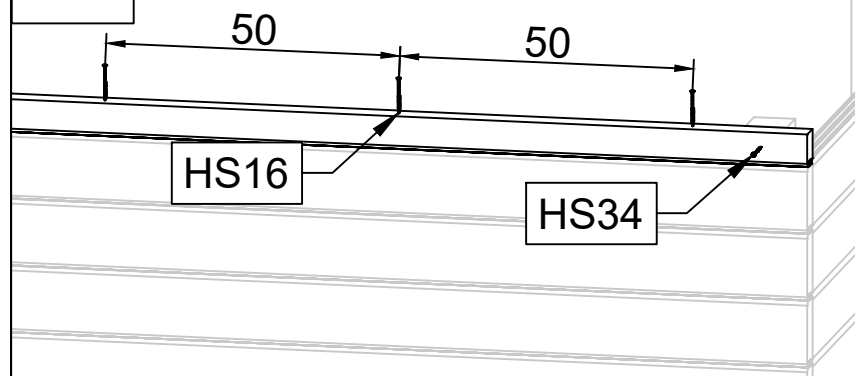

22

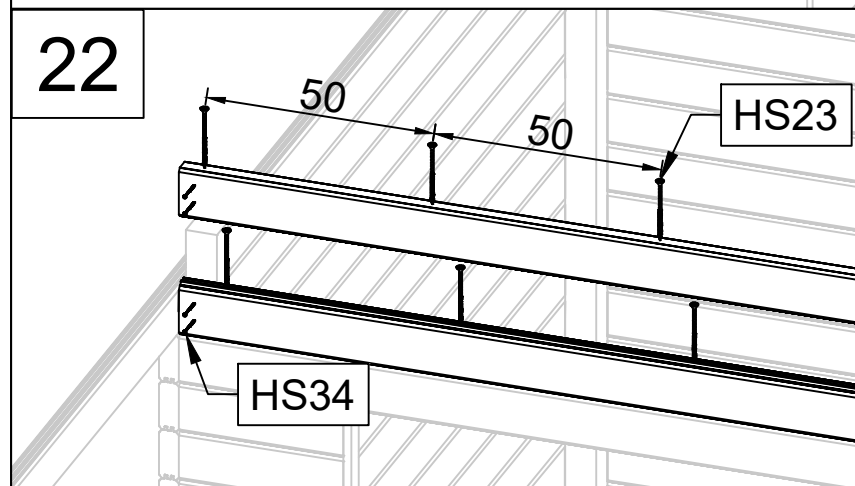

23

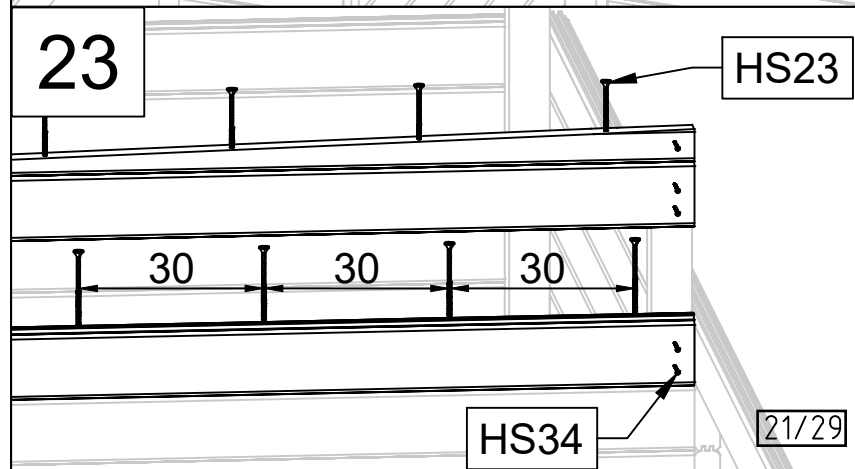

21/29

Art. Nr. 4426019

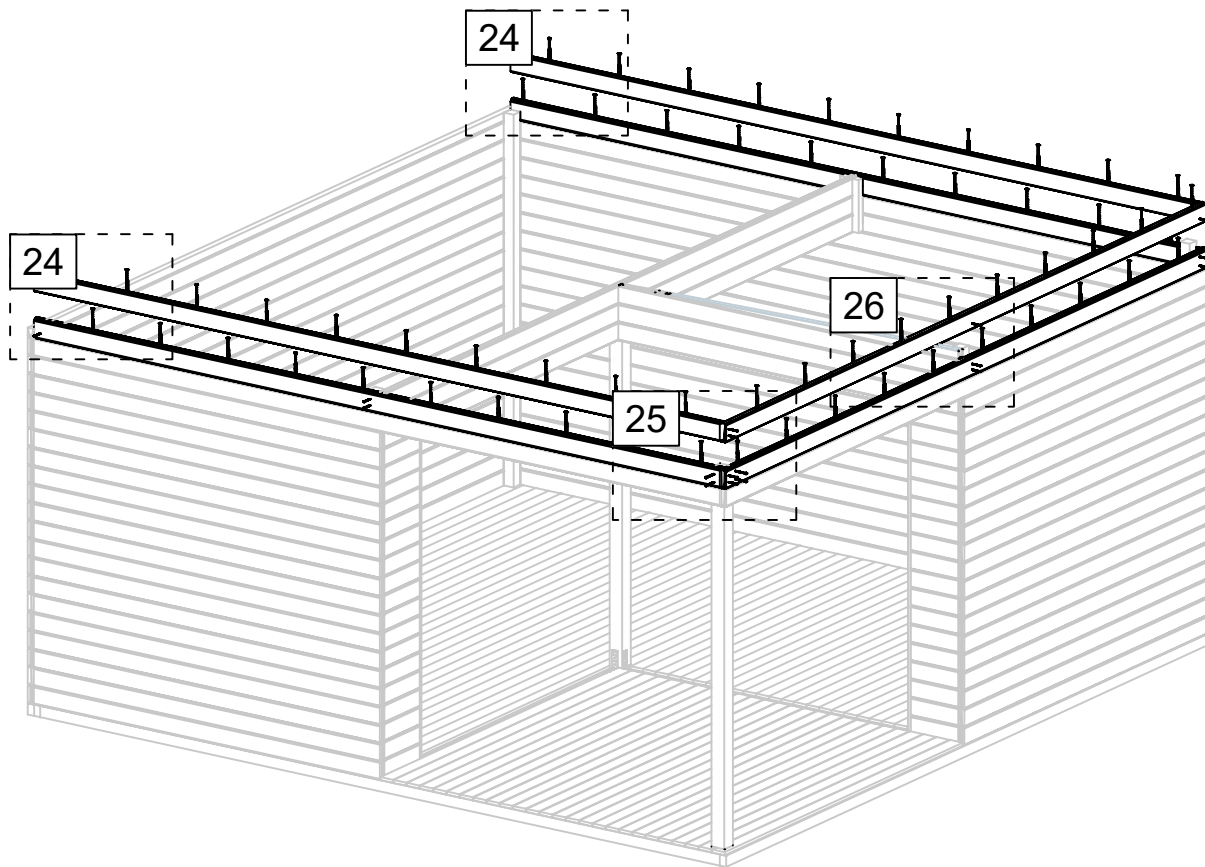

24

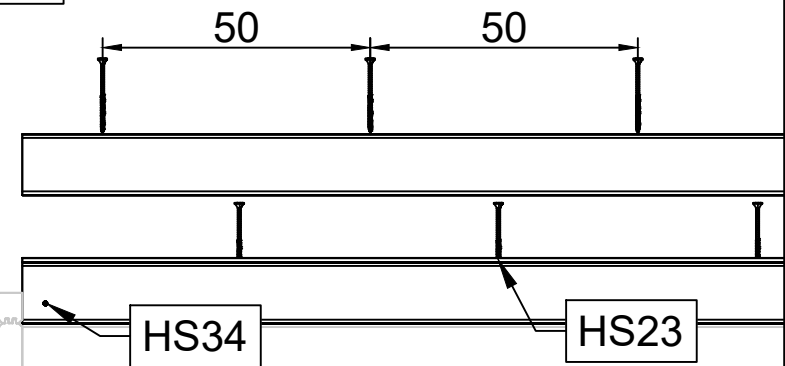

25

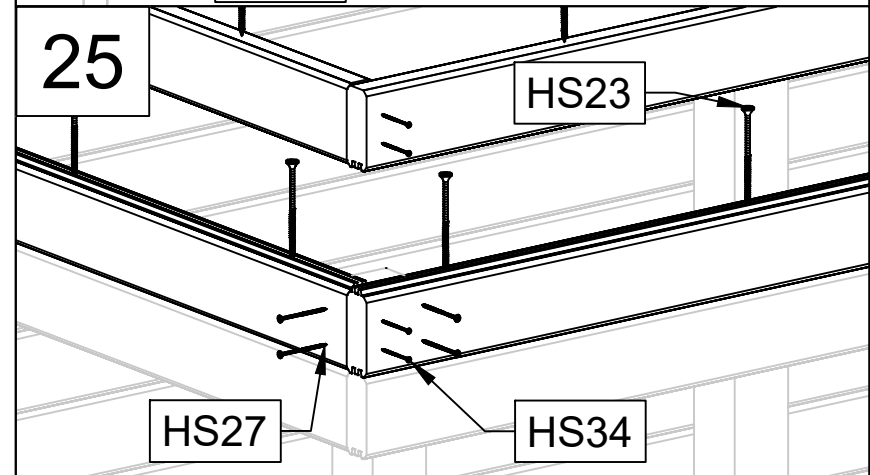

26

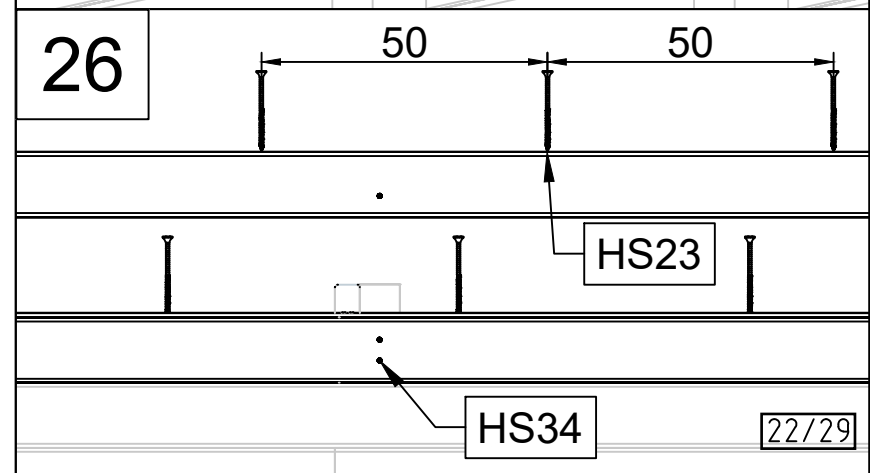

29.10.2020

22/29

Art. Nr. 4426019

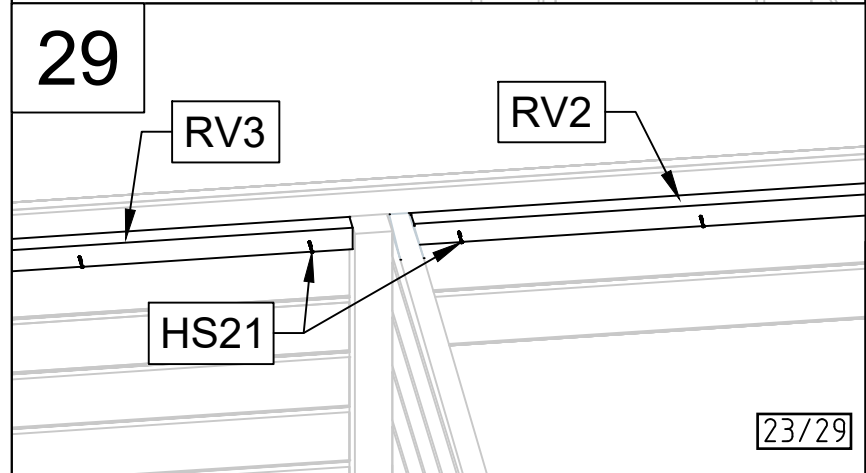
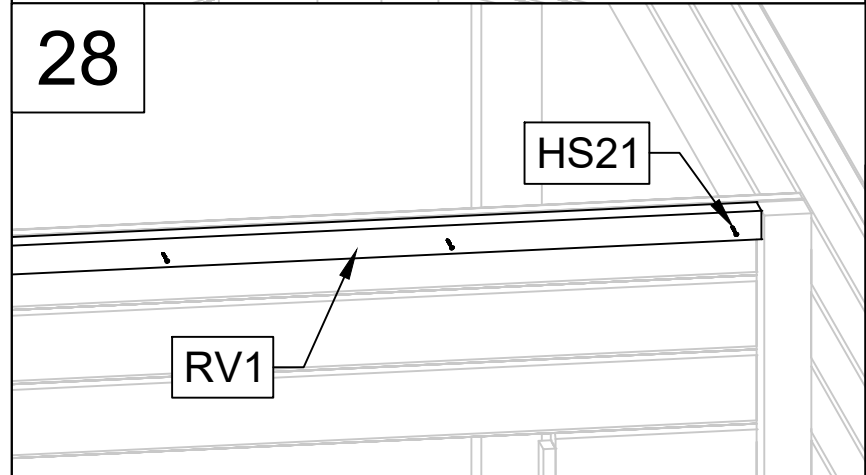
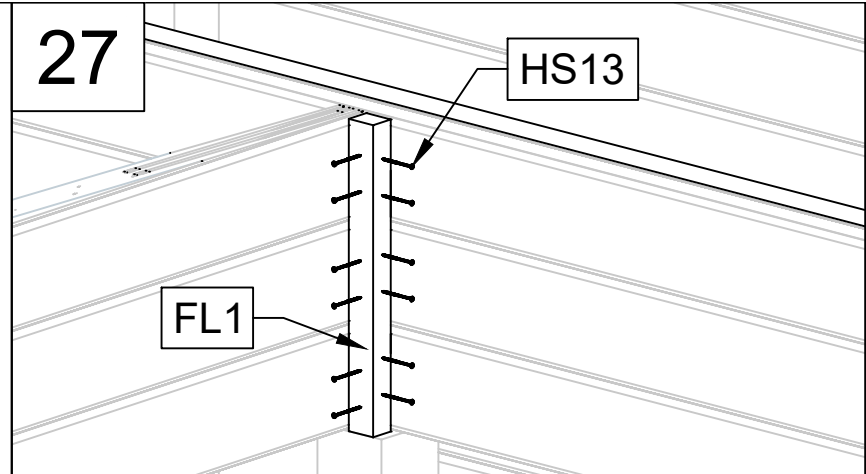
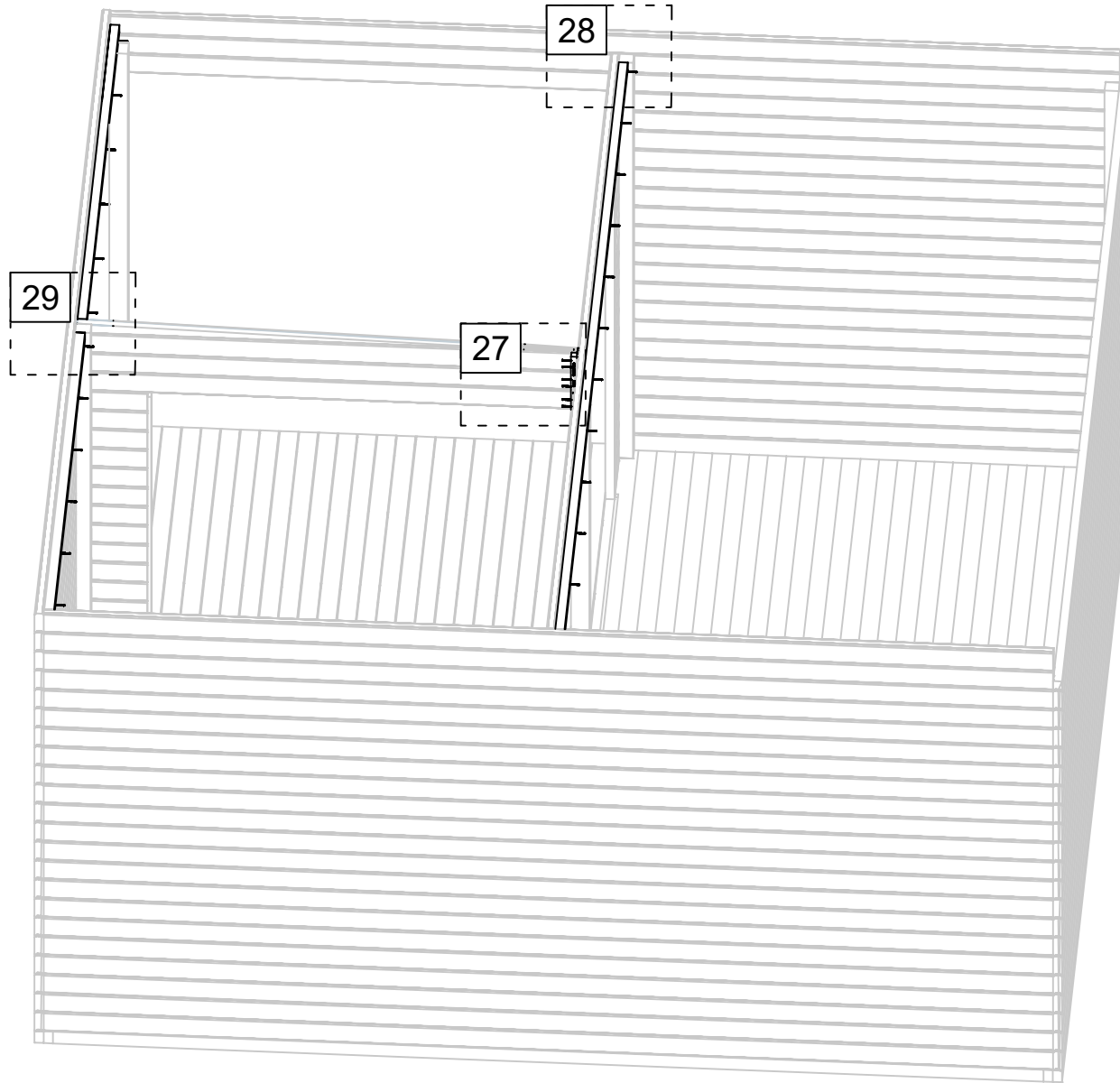

29.10.2020

23/29





Art. Nr. 4426019

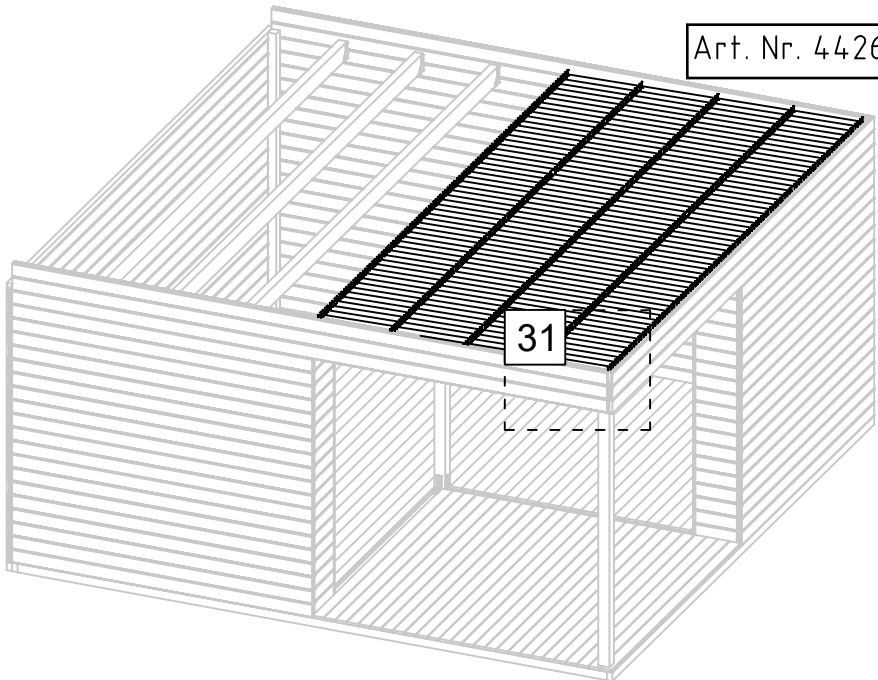

31

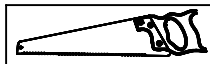

DB2

NF4

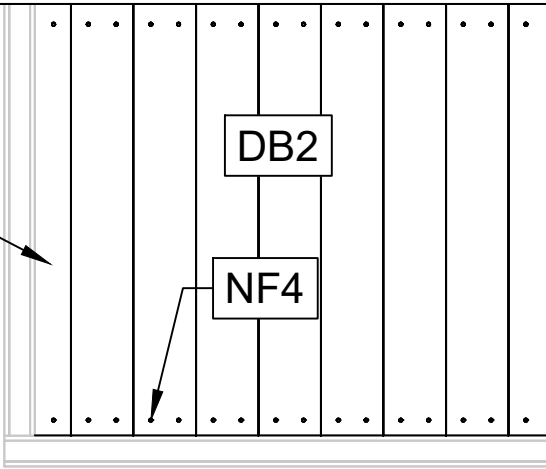

32



NF4

DB1

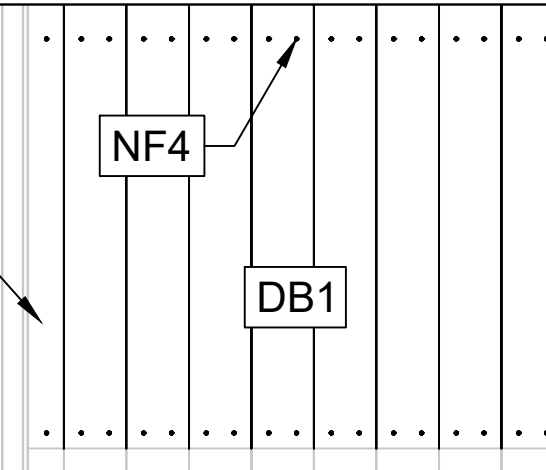

33

HS34

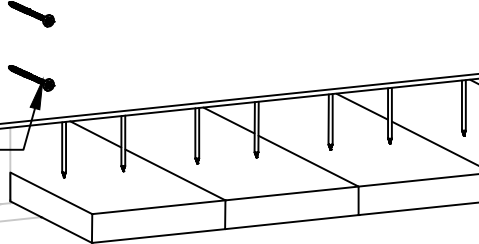

33

32

33

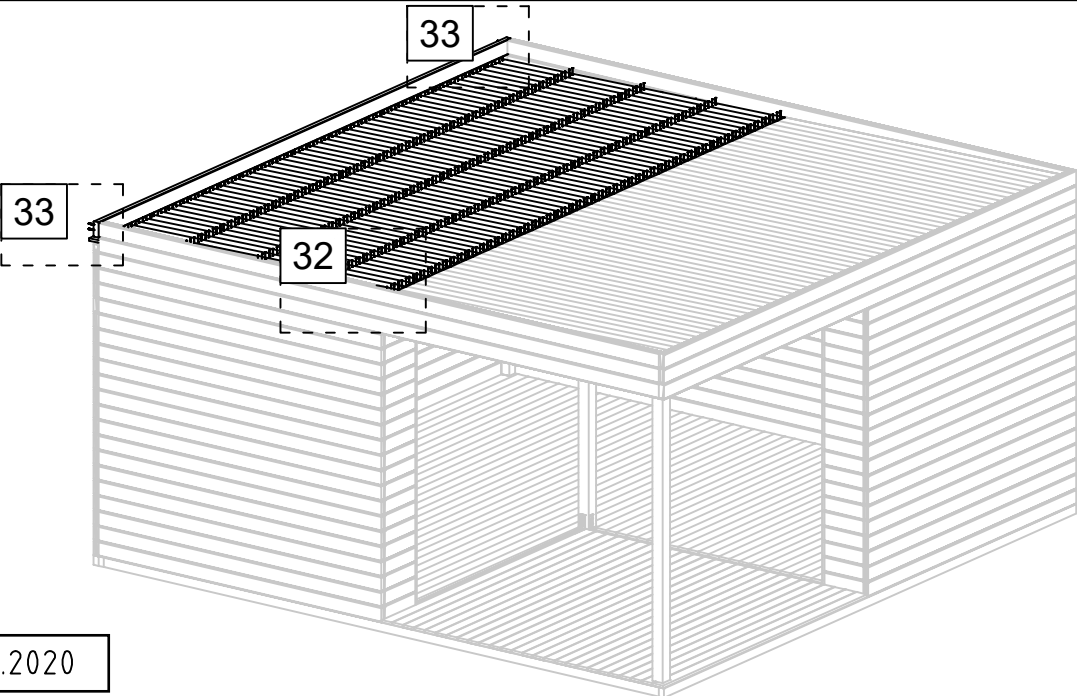

29.10.2020

25/29

Art. Nr. 4426019

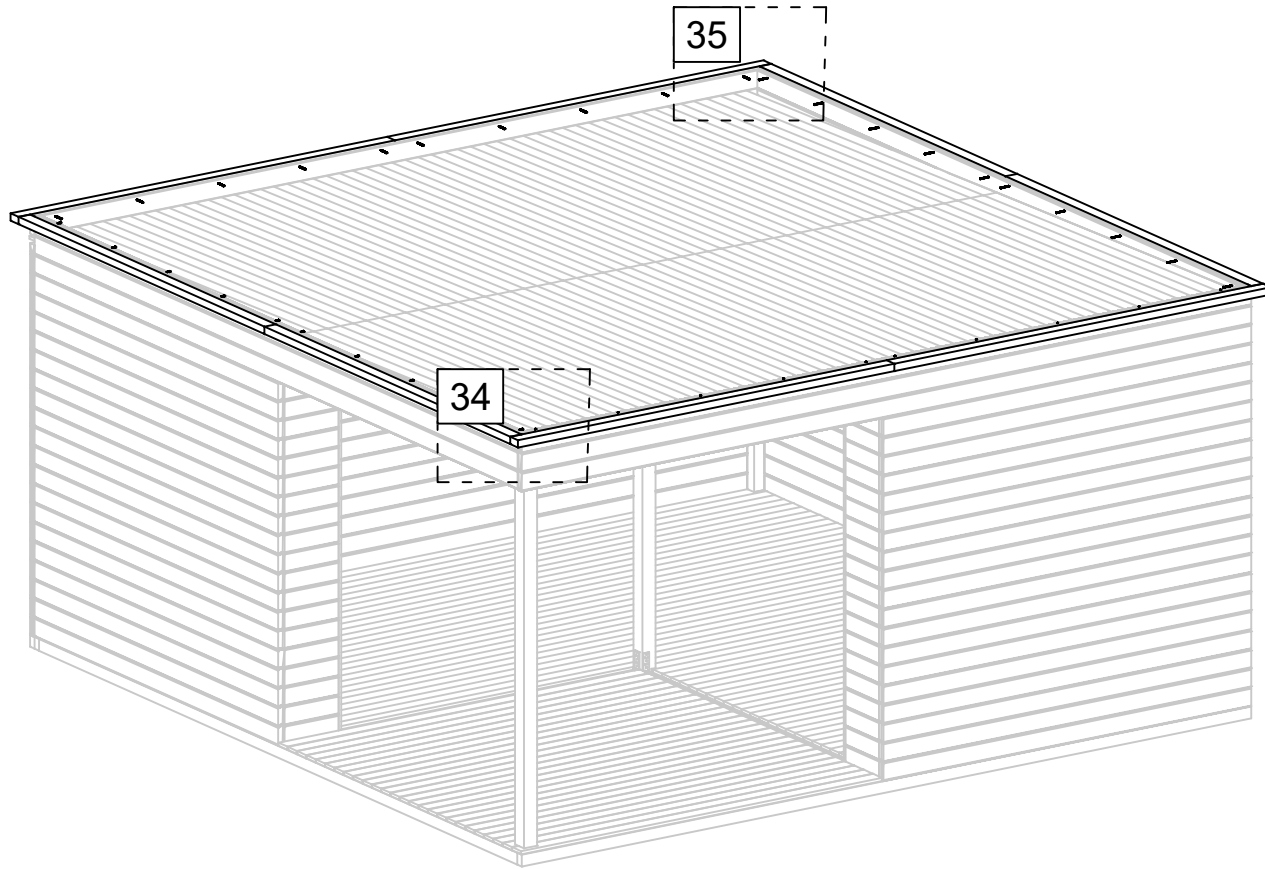

34

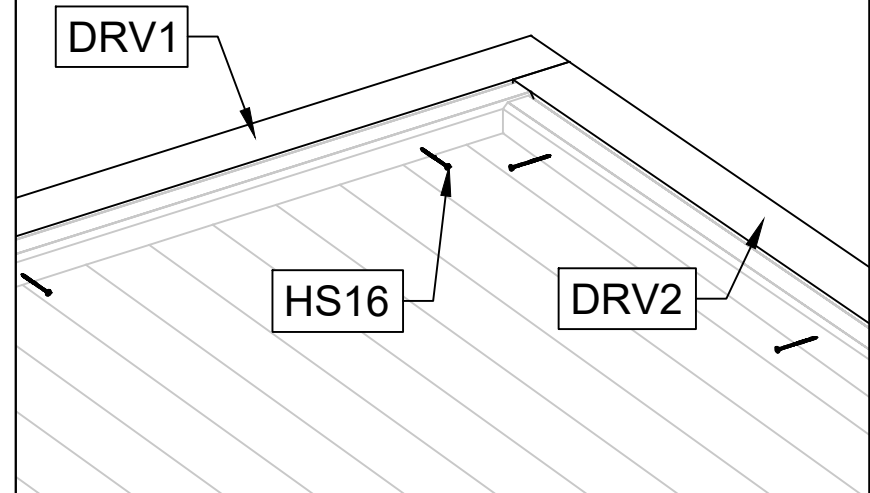

35

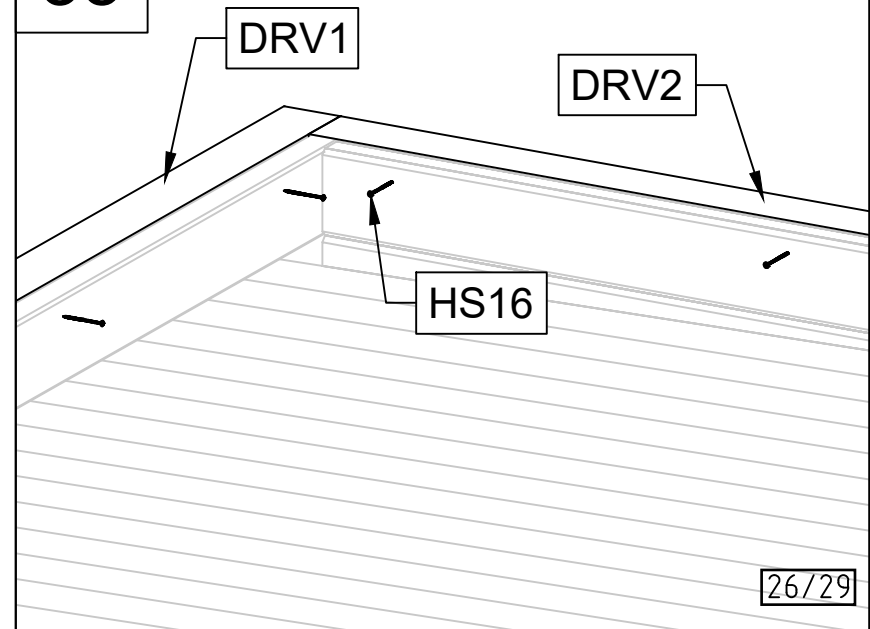

Art. Nr. 4426019

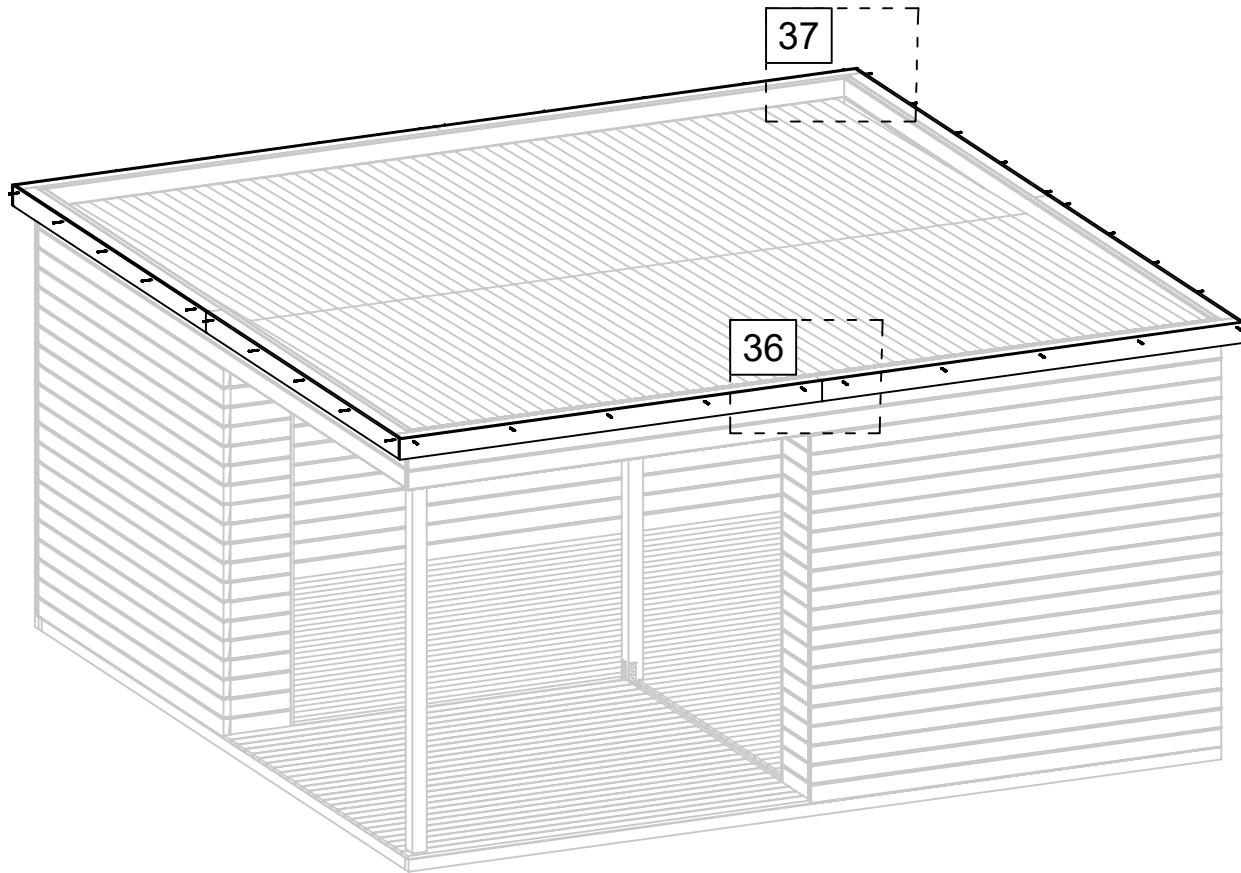

36

HS12

GL2

37

HS12

GL1

GL2

29.10.2020

27/29

Art. Nr. 4426019

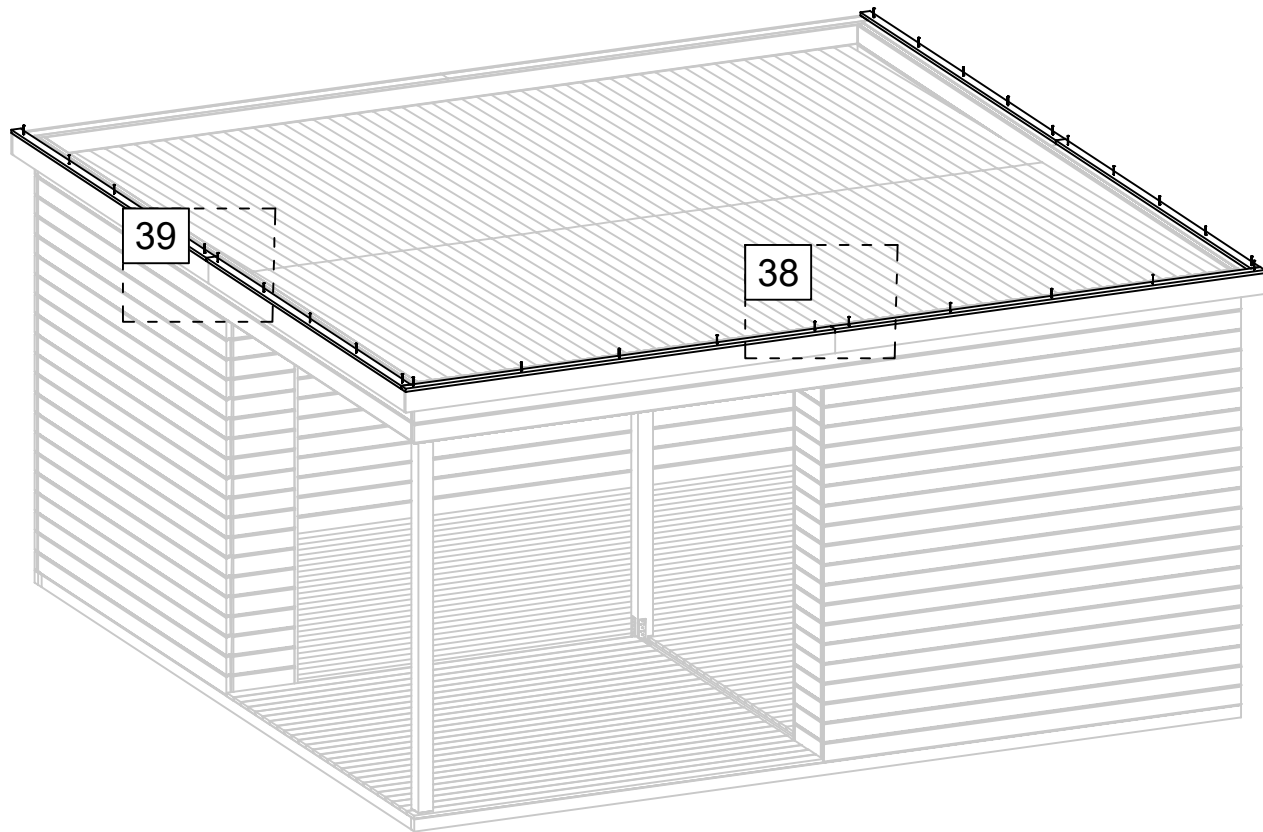

38

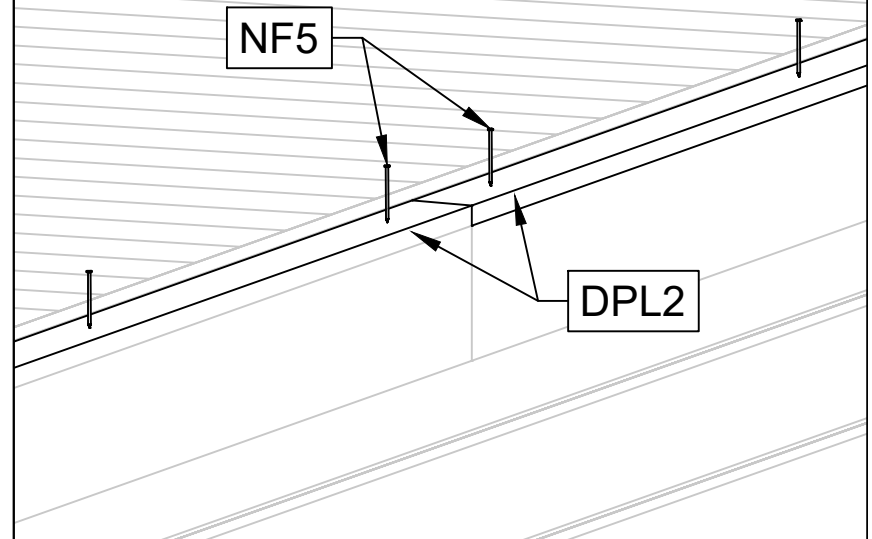

39

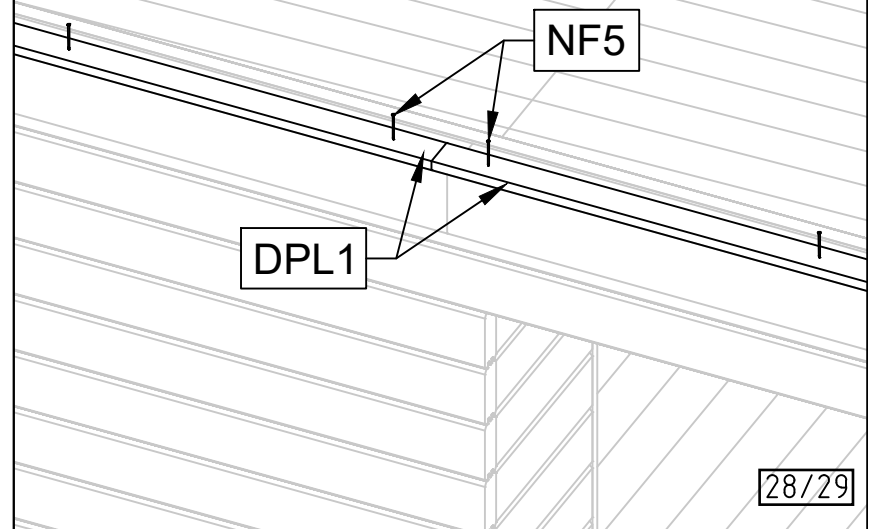

29.10.2020

28/29

Art. Nr. 4426019

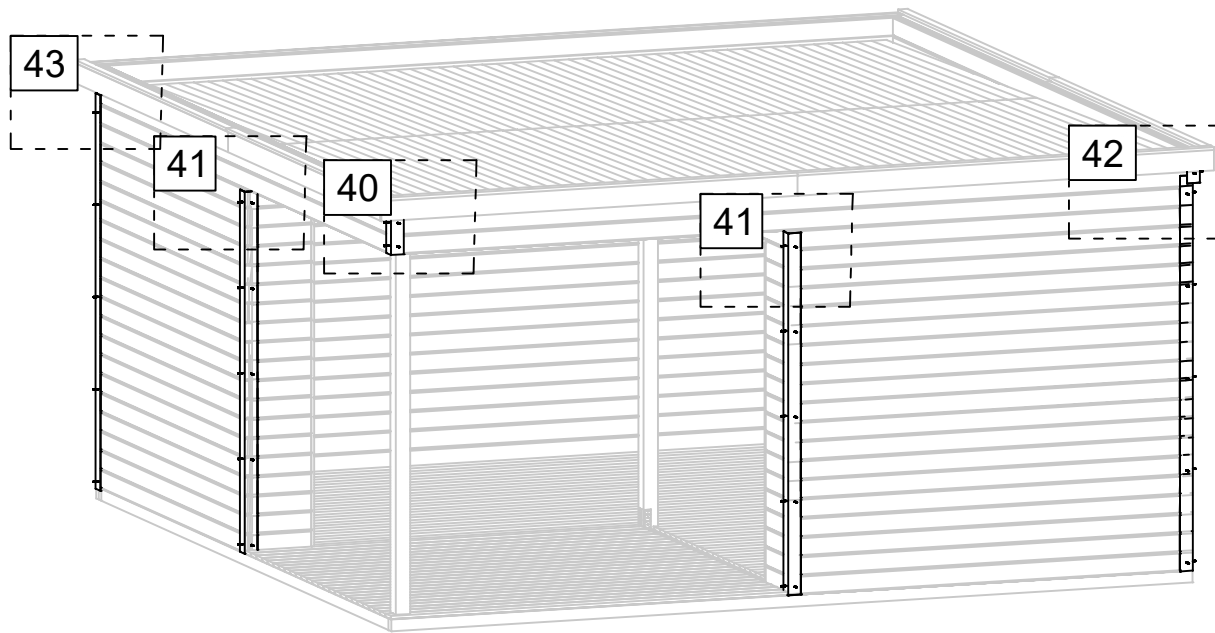

42

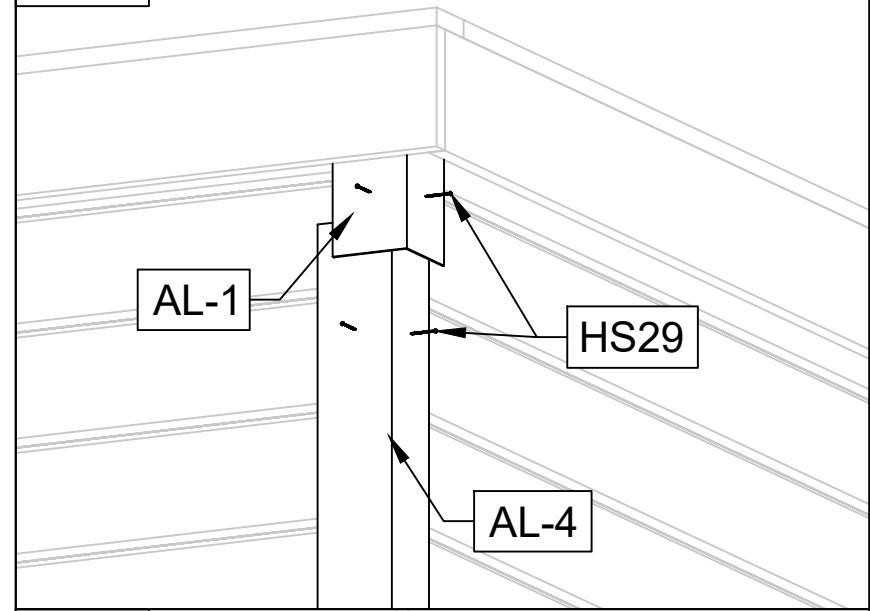

43

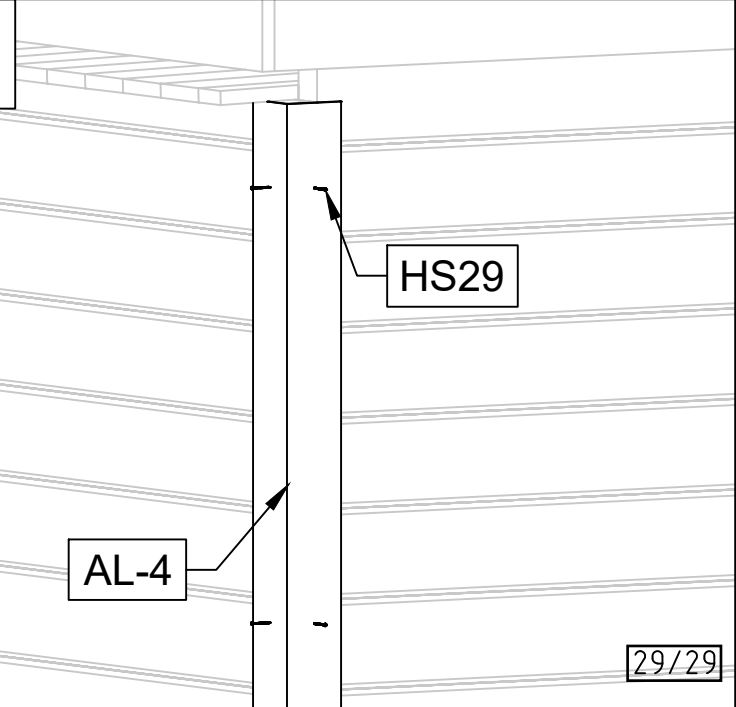

40

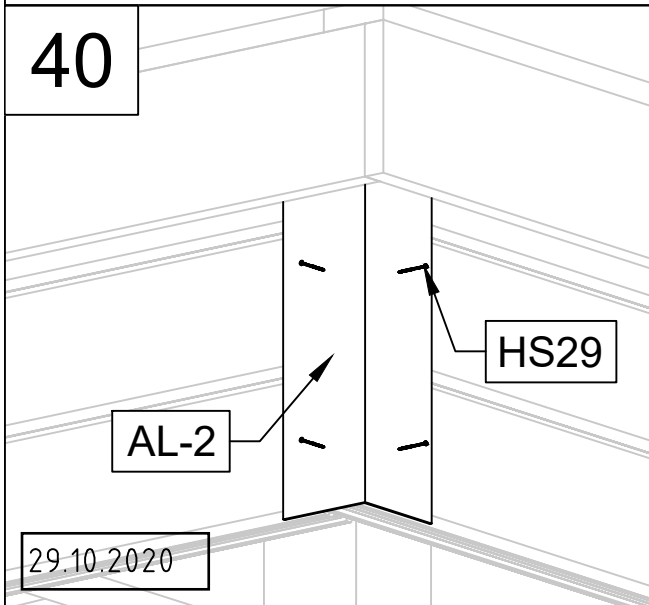

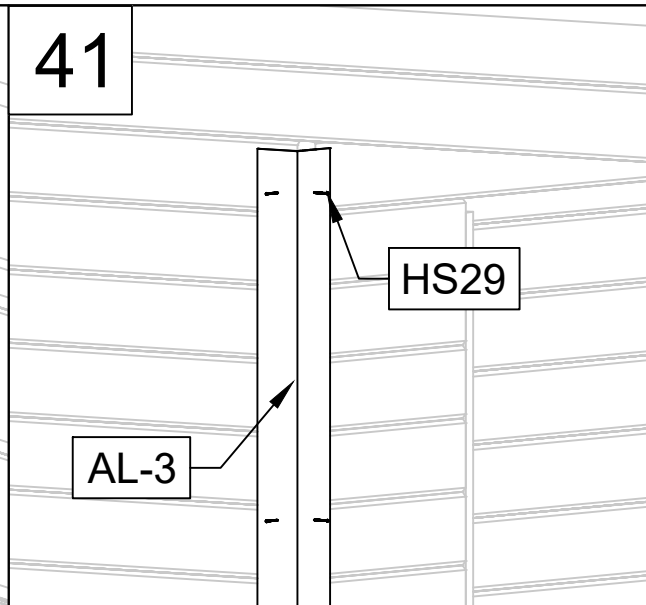

29.10.2020

41



29/29

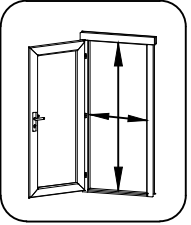
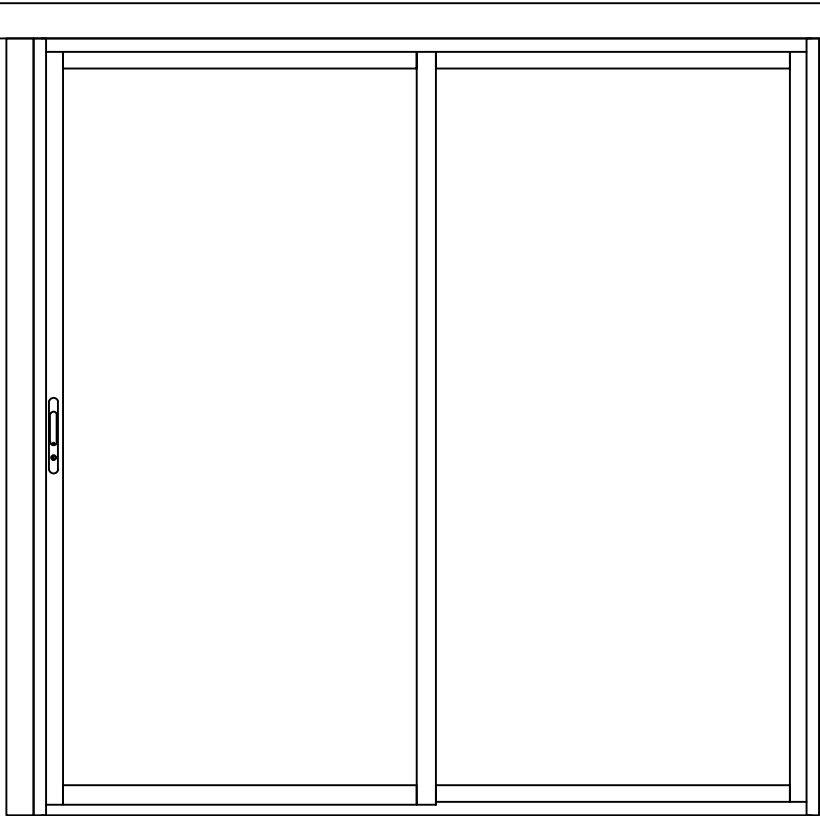
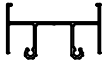

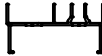
Pos	25.06.2020 Piece list - Stückliste - Liste des pièces - Elementi - Stuklijst - Tükítabel 2041x2026 ALP.2S.2R. RAL7016	1/1	Q	P (mm)	L (mm)
Glass size - Glasgröße - Taille de la vitre - Misura del vetro - Glas afmeting - Klaasi mõõt: 926x1859 mm				 950x1930 mm	
					
12	Upper door jamb - Türrahmen oben - Cadre de porte supérieur - Telaio superiore della porta - Bovendorpel - Ükse ütemine teng		1	35x60	1982
9	Doorstep - Swelle - Seuil de porte - Callare - Drempel - Lävepakk ukseavale		1	35x60	1982
10-11	Door jamb - Türrahmen - Cadre de porte - Telaio montante della porta - Deurframe - Ükse teng		2	32x63	2000

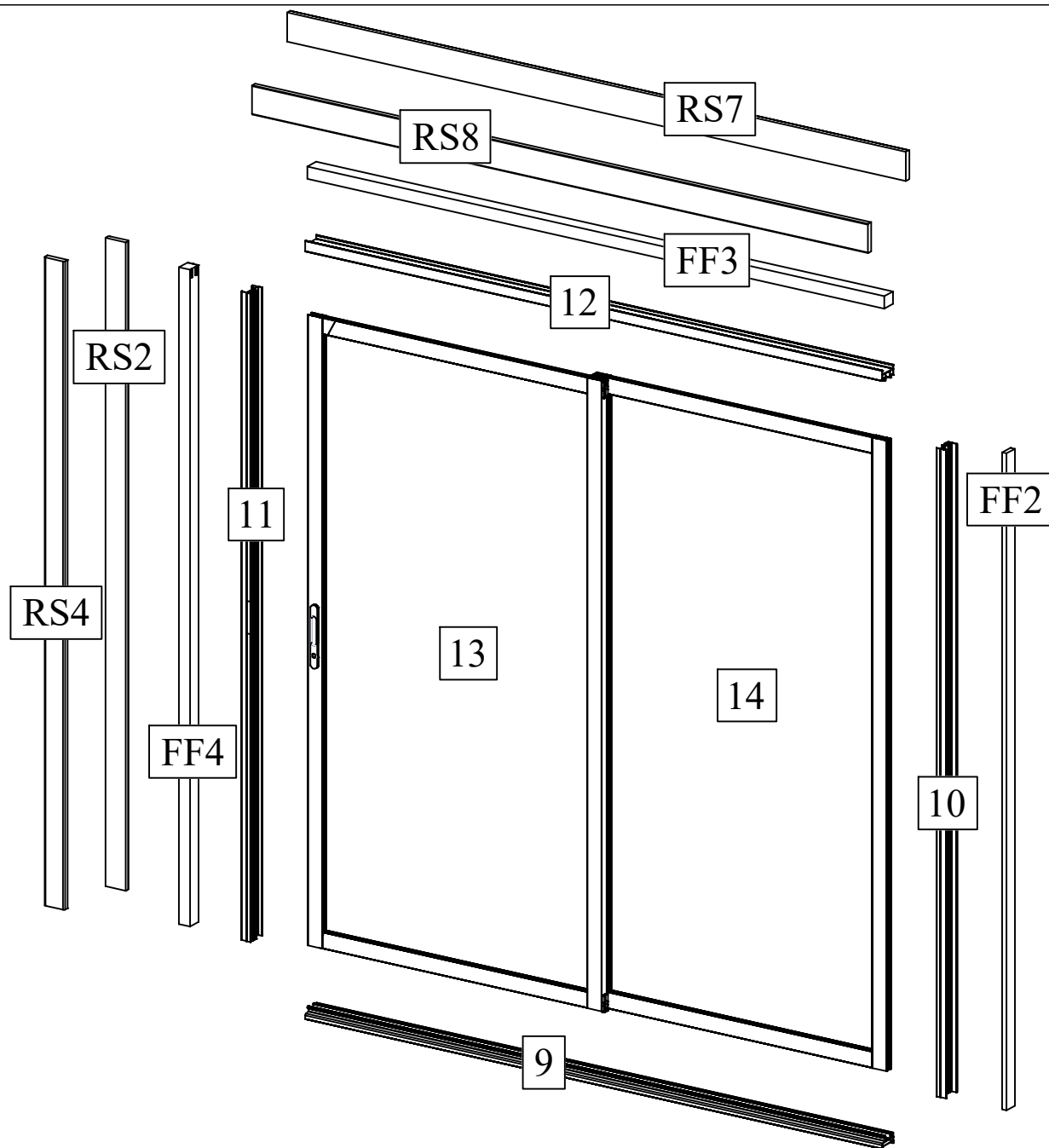



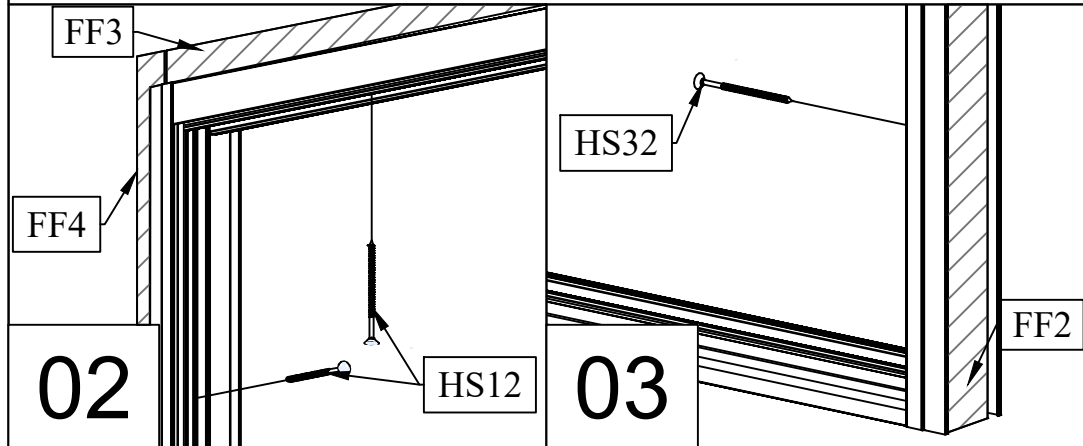
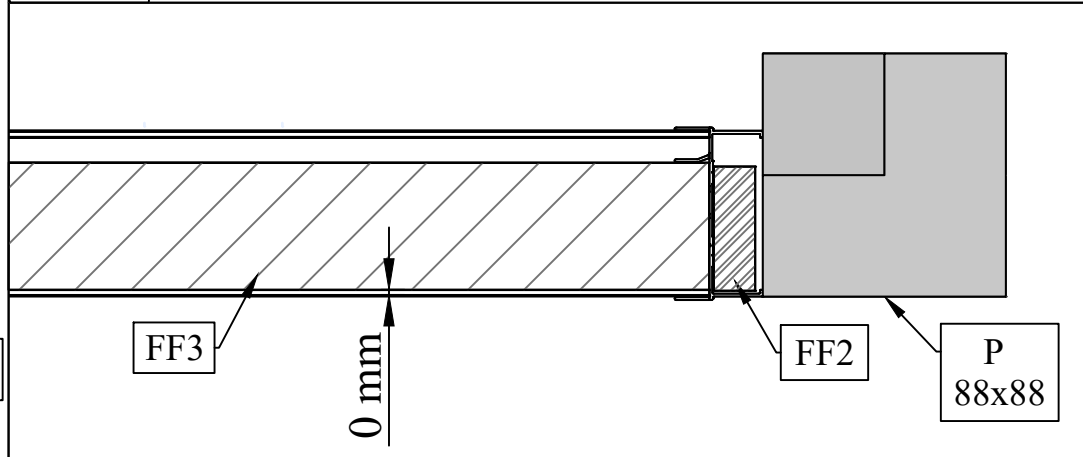
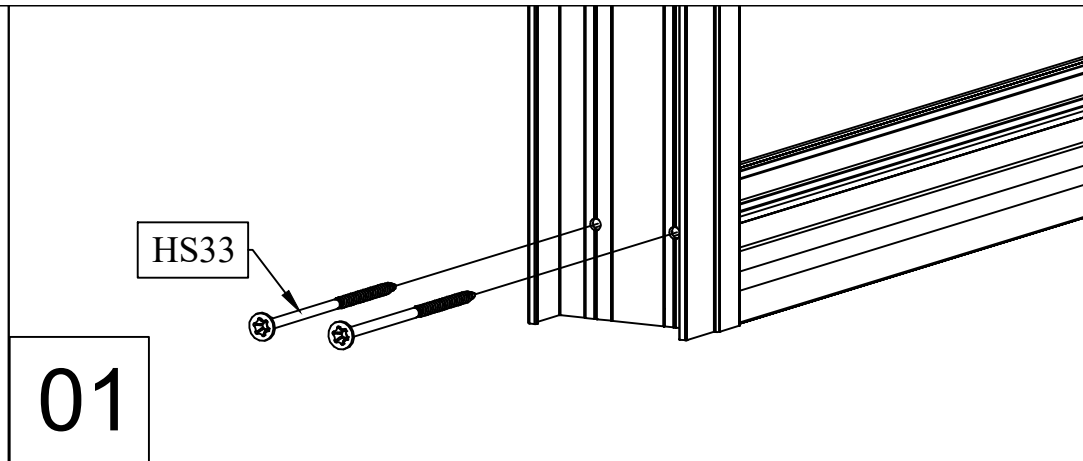
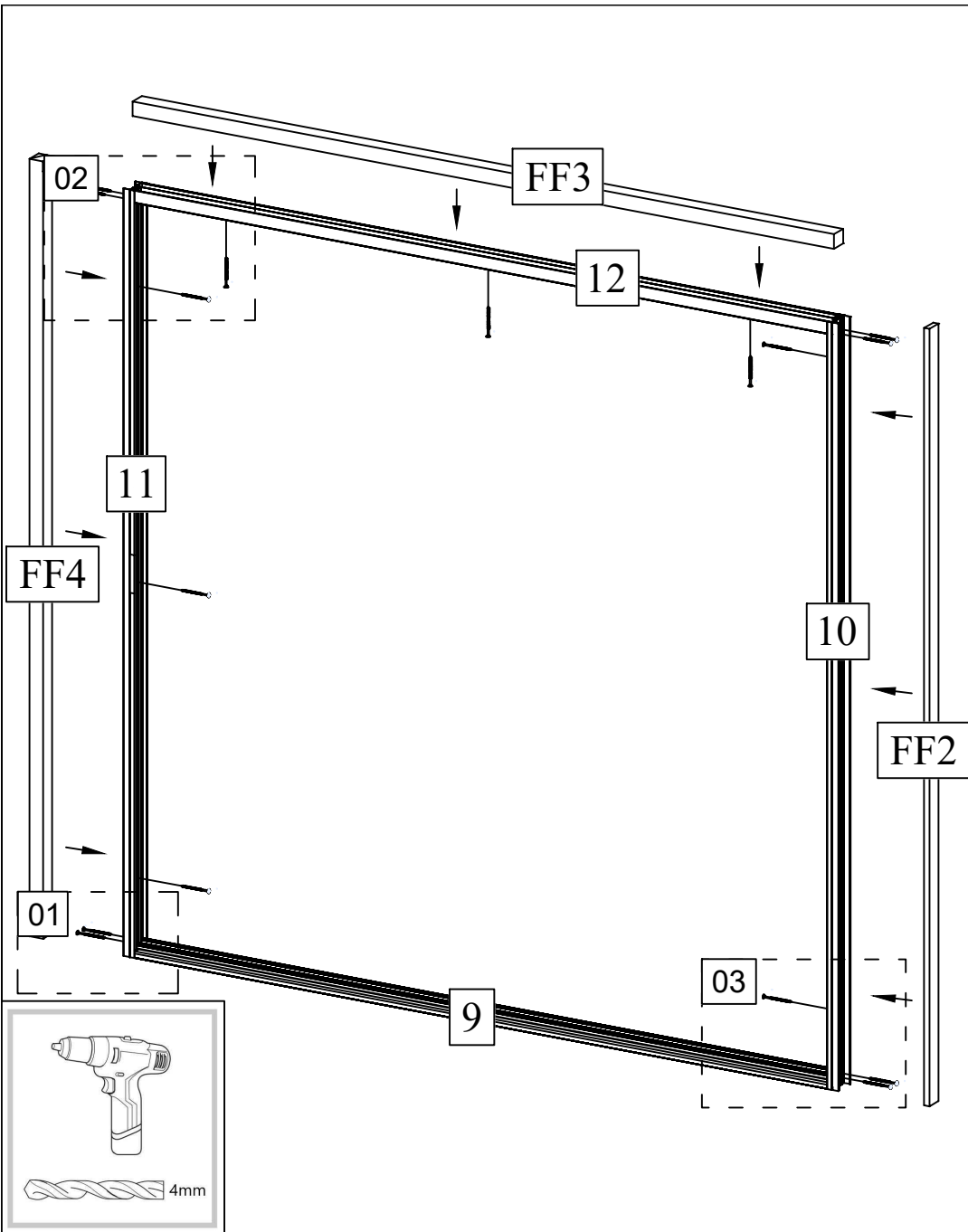

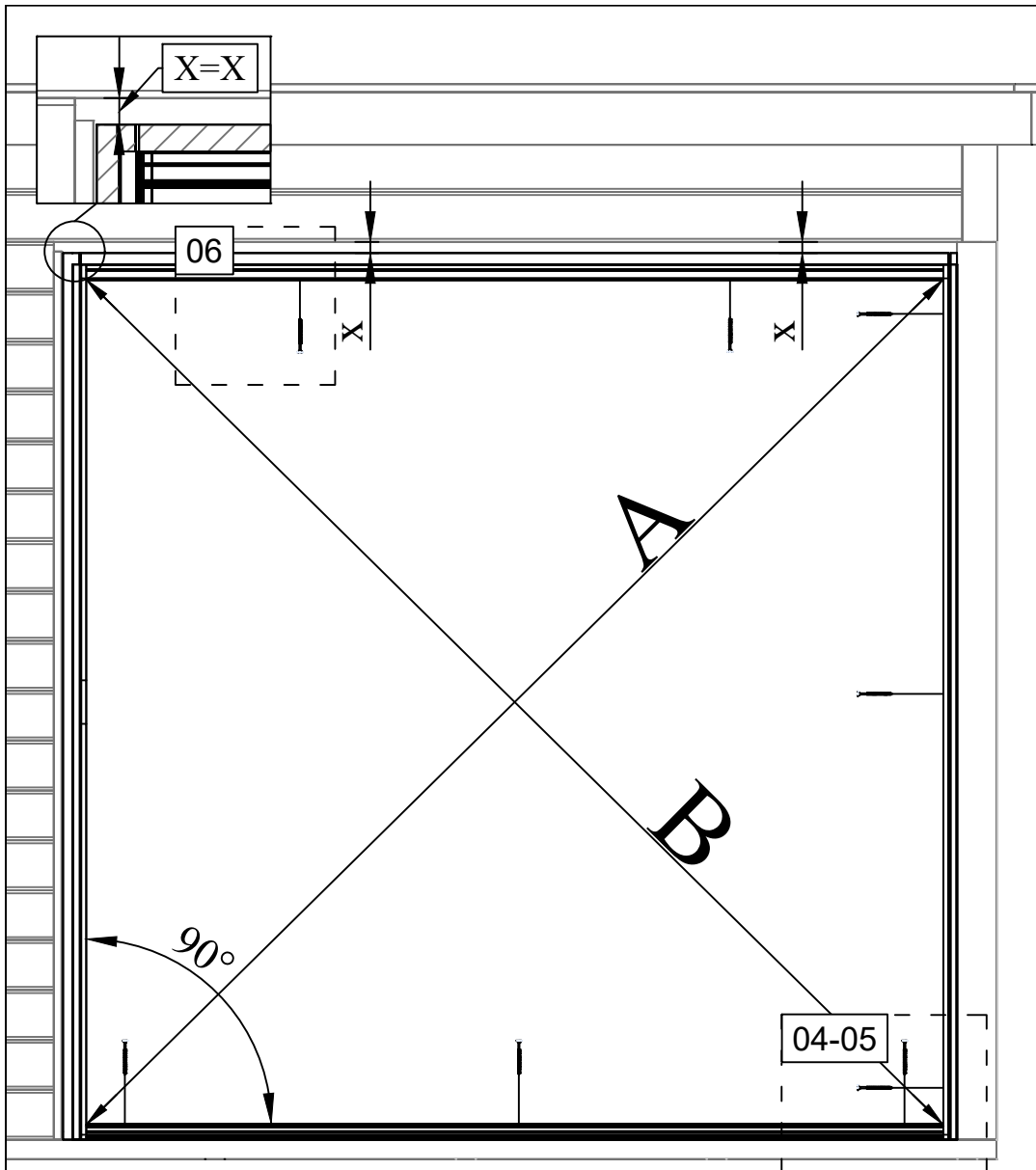

**A=B**

**04**

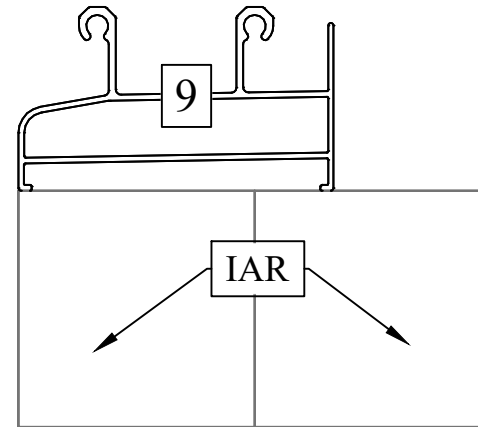

**05**

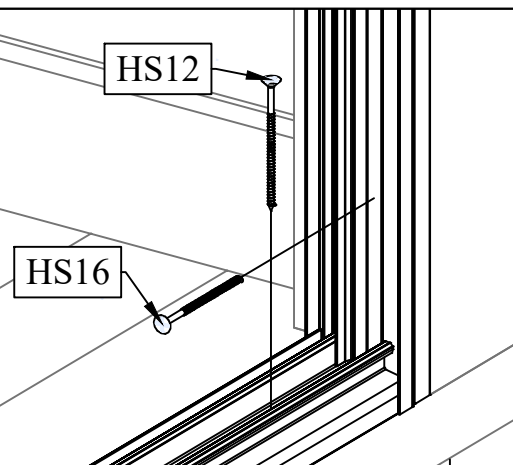

**06**

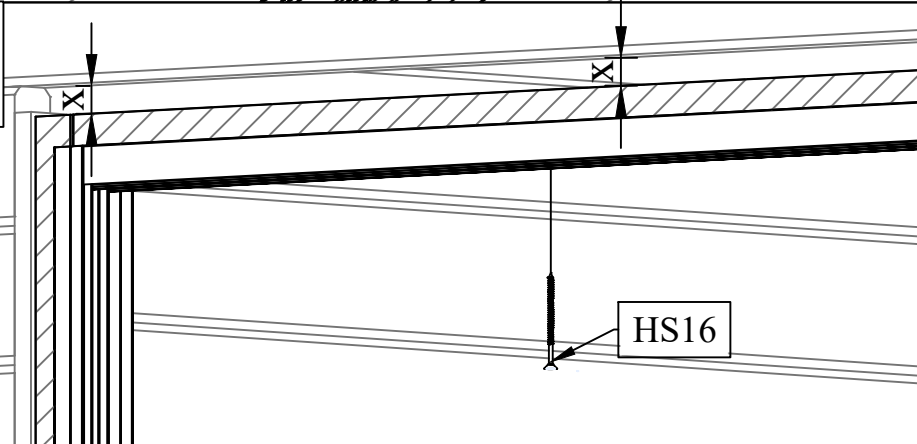

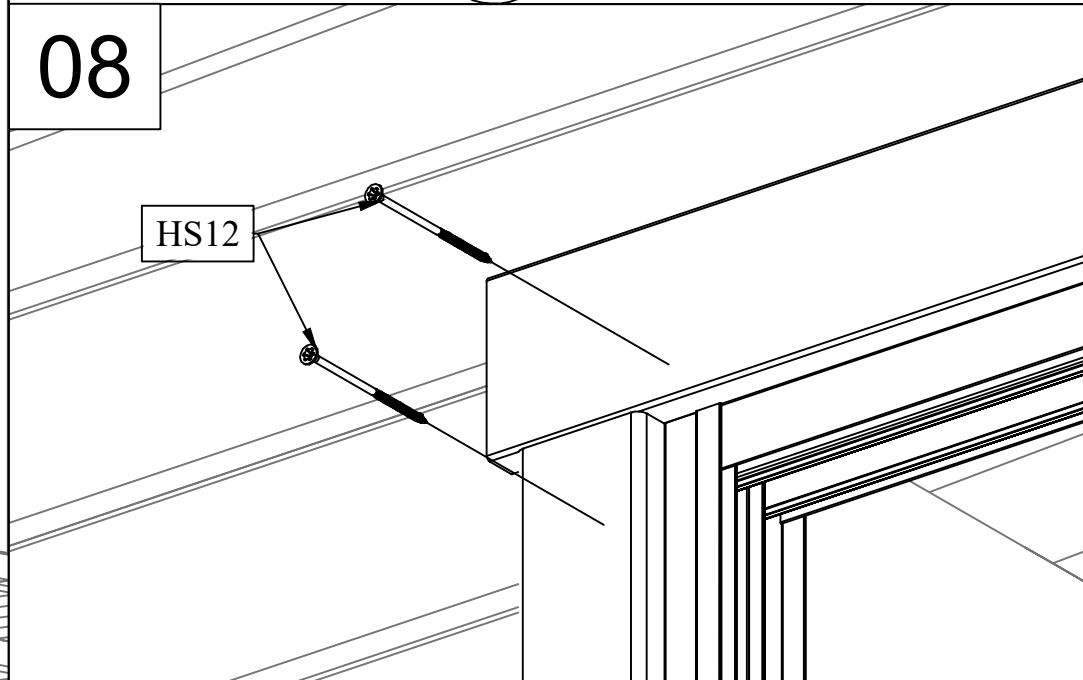
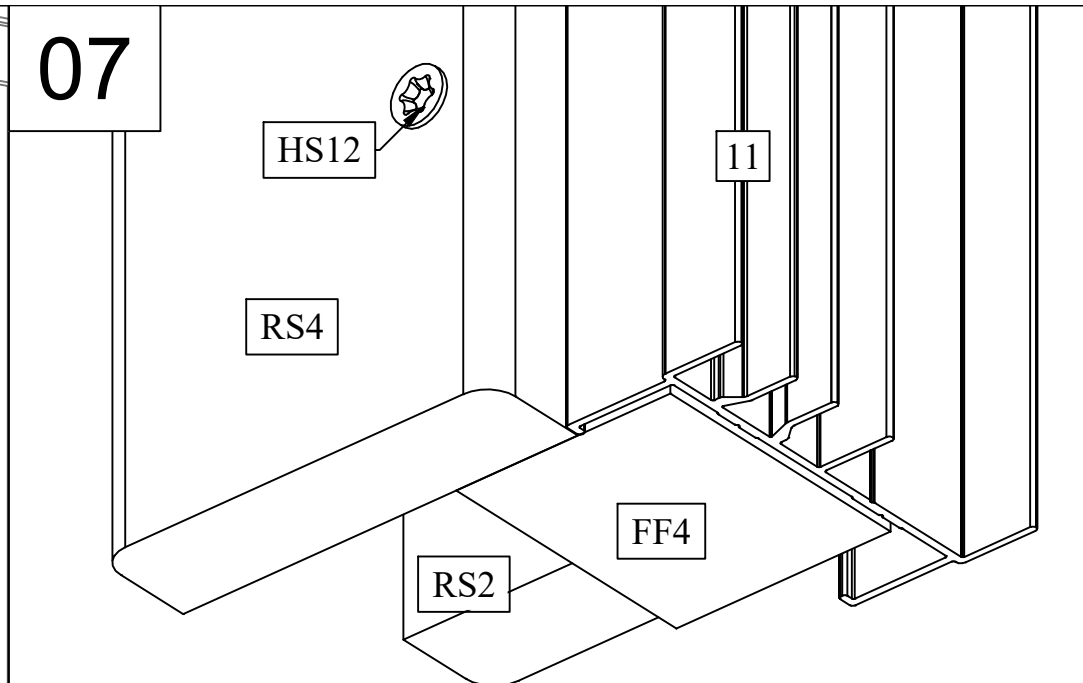
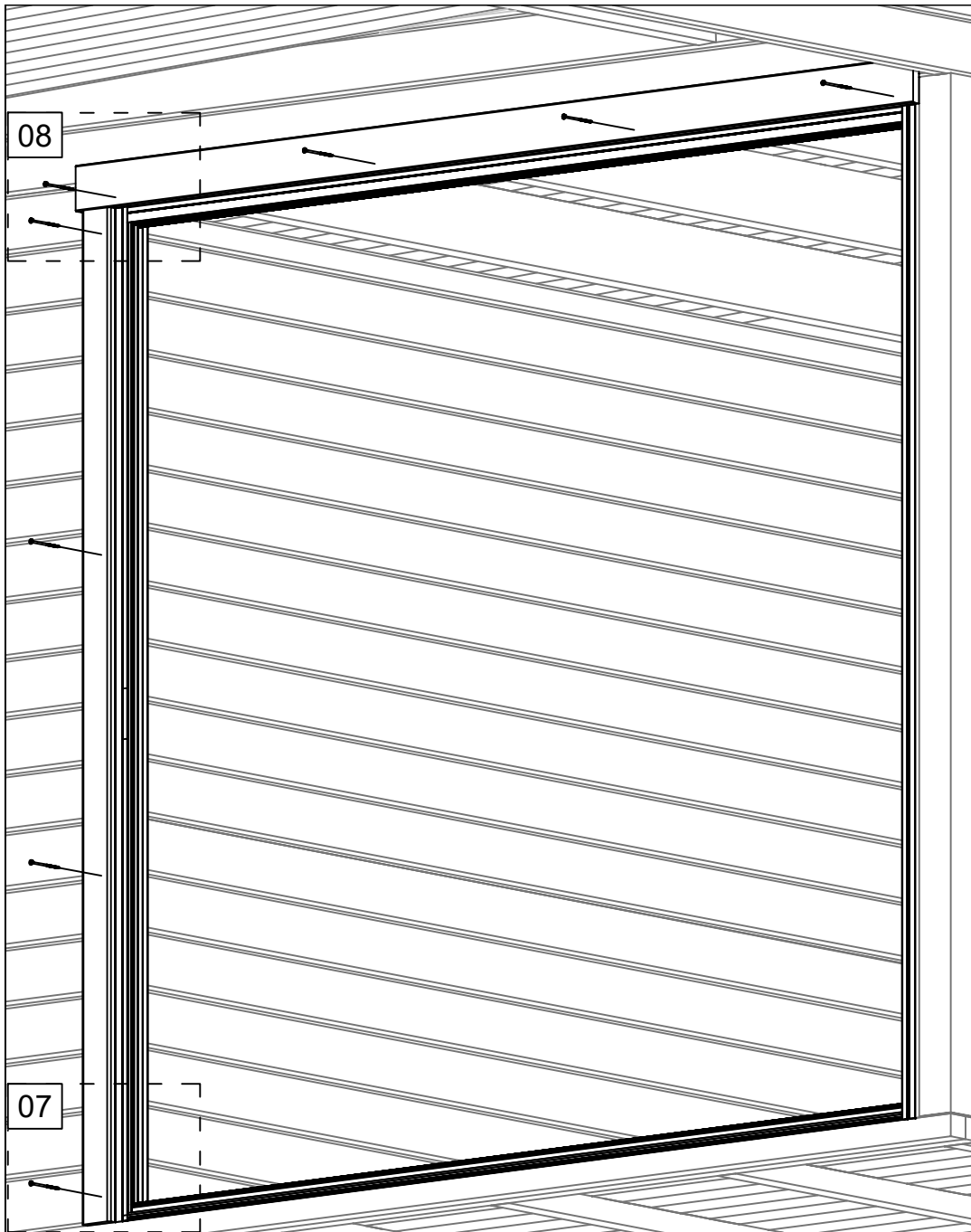

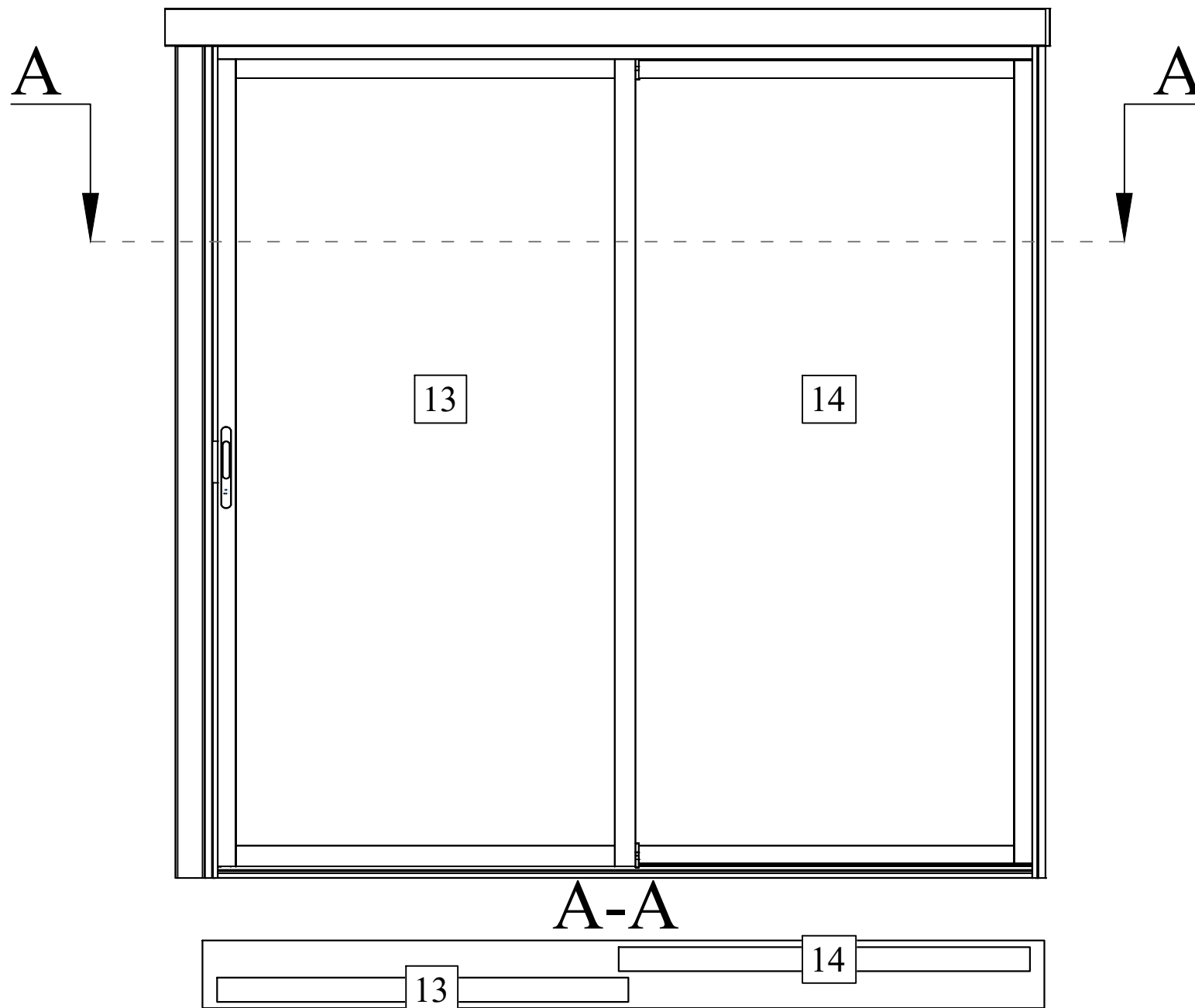

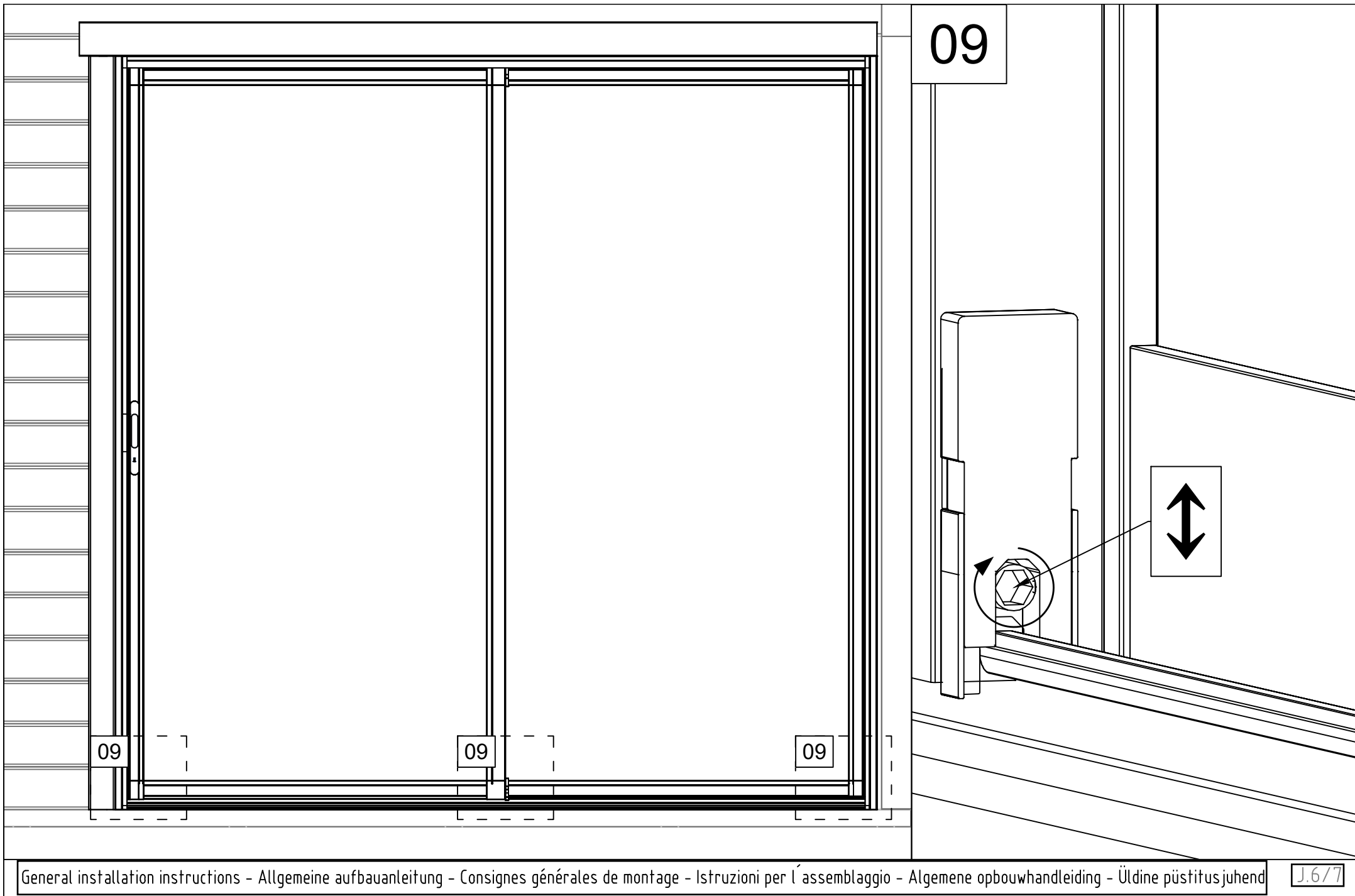

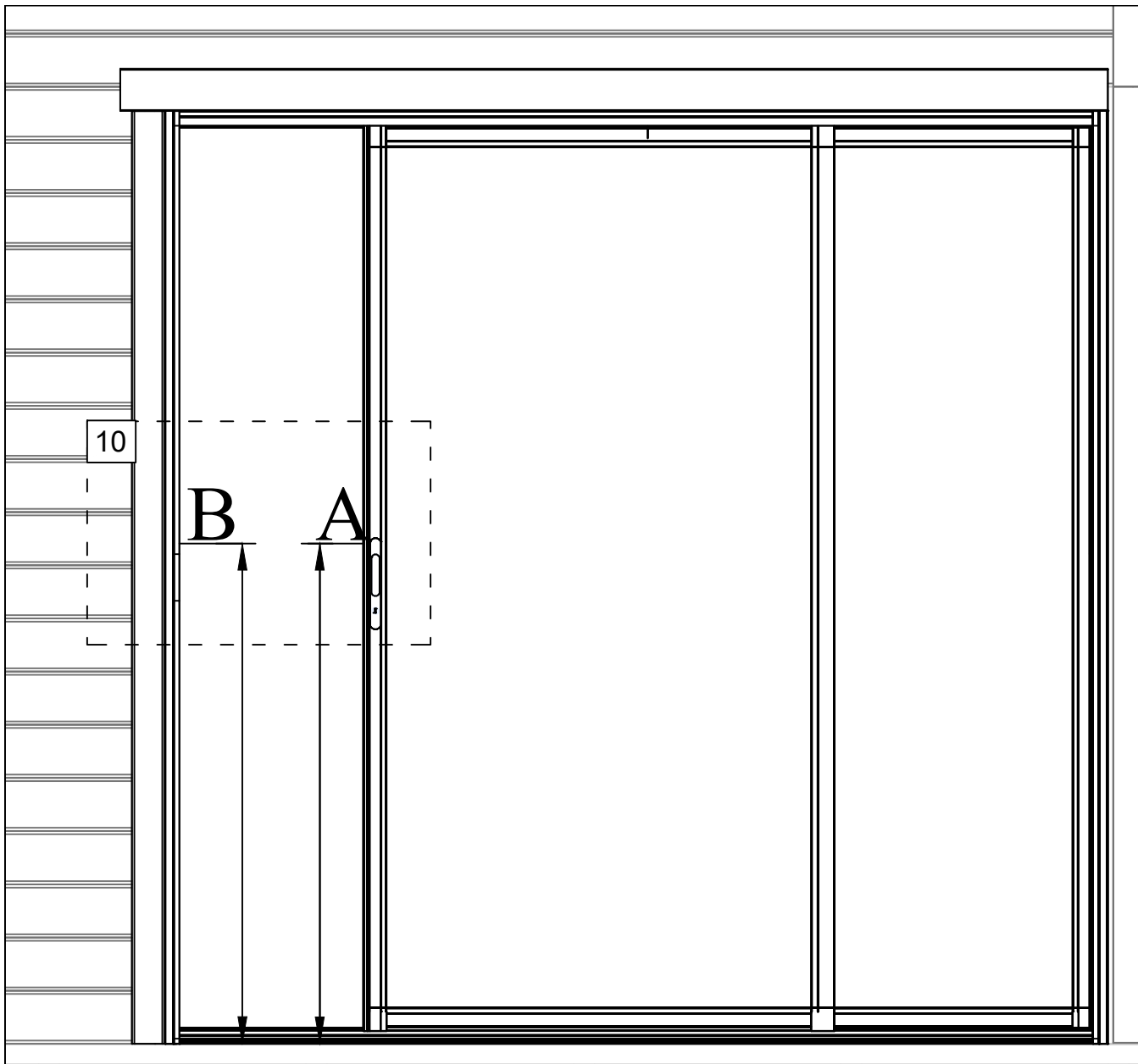

$$A=B$$

10

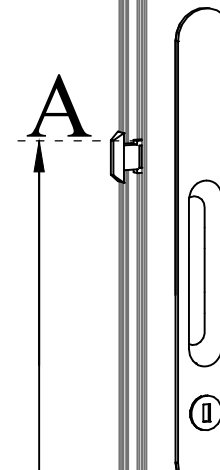



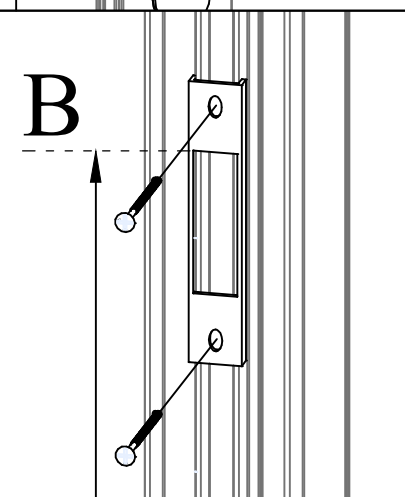

10

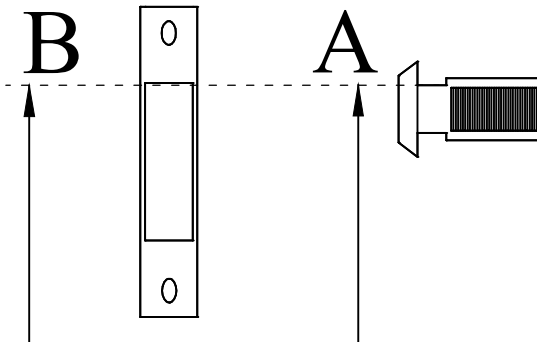

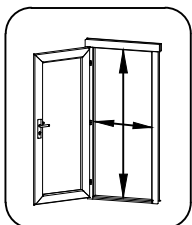
B

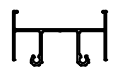

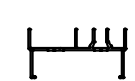
Pos	24.09.2020 <span style="float: right;">Piece list - Stückliste - Liste des pièces - Elementi - Stuklijst - Tükítabel</span> <span style="float: right;">2041x2026 ALP.2S.2R.P RAL7016</span>	1/1	Q	<span style="border: 1px solid black; padding: 2px;">P</span> (mm)	<span style="border: 1px solid black; padding: 2px;">L</span> (mm)
Glass size - Glasgröße - Taille de la vitre - Misura del vetro - Glas afmeting - Klaasi mõõt: 926x1859 mm				 <div style="border: 1px solid black; padding: 2px; width: fit-content; margin: 0 auto;">950x1930 mm</div>	
					
12	Upper door jamb - Türrahmen oben - Cadre de porte supérieur - Telaio superiore della porta - Bovendorpel - Ukse ütemine teng		1	35x60	1982
9	Doorstep - Swelle - Seuil de porte - Callare - Drempe - Lävepakk ukseavale		1	35x60	1982
10-11	Door jamb - Türrahmen - Cadre de porte - Telaio montante della porta - Deurframe - Ukse teng		2	32x63	2000

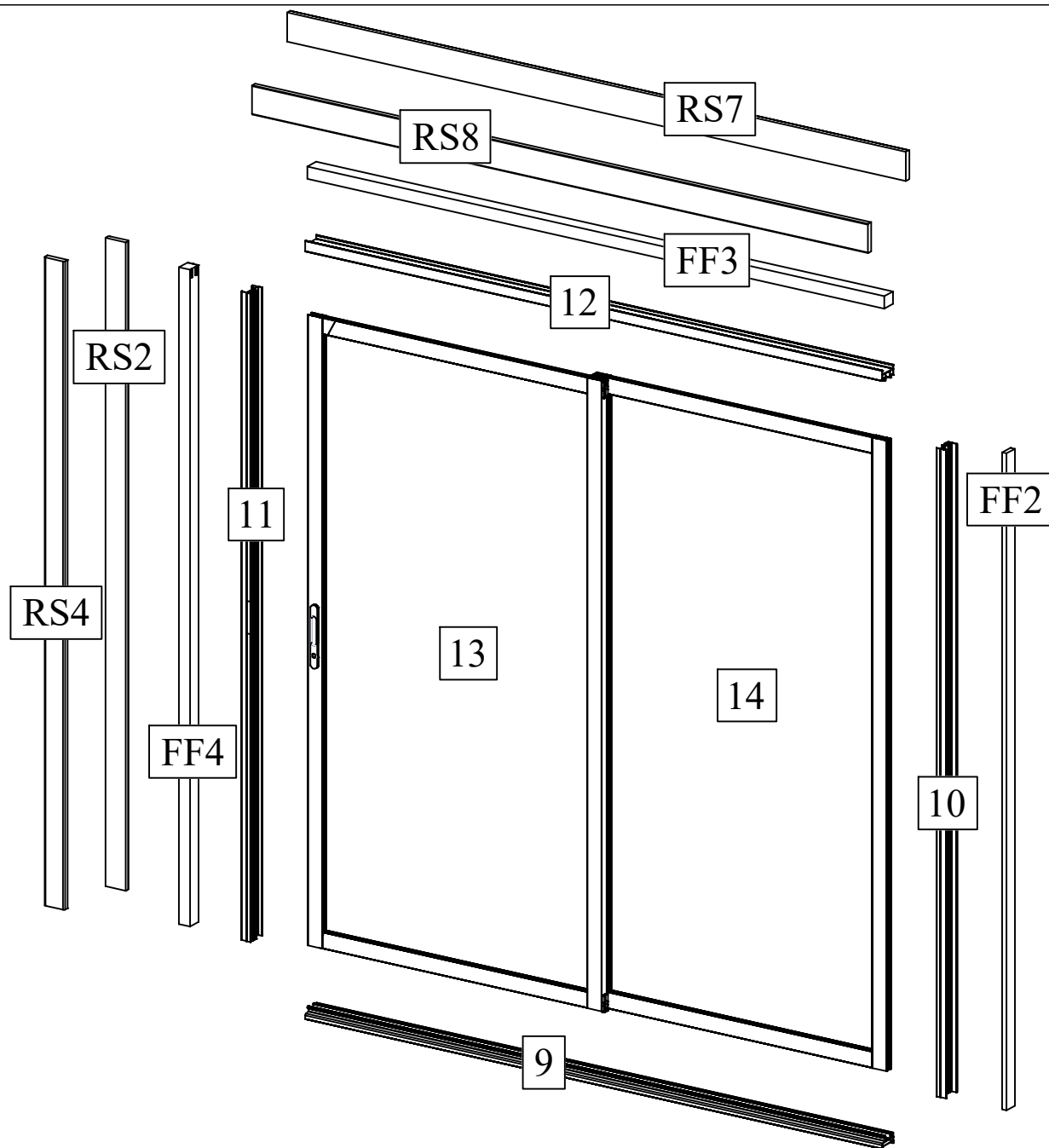



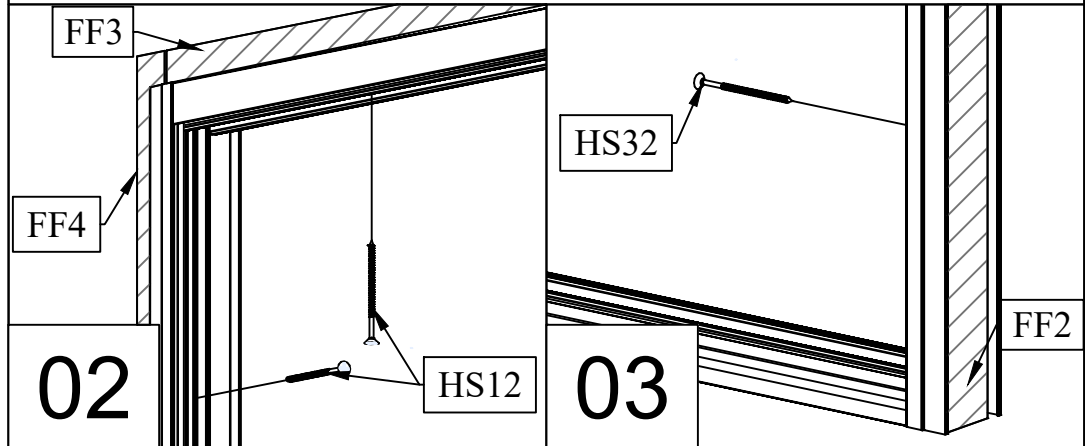
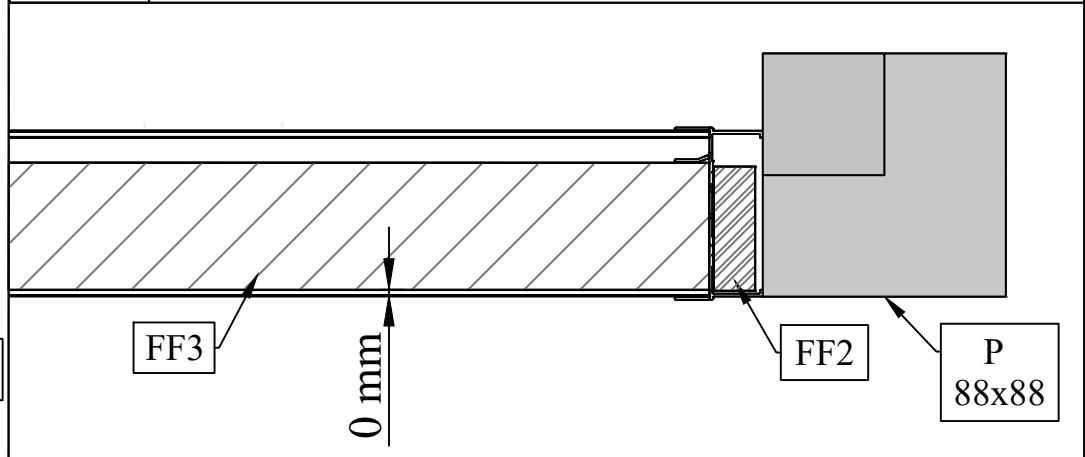
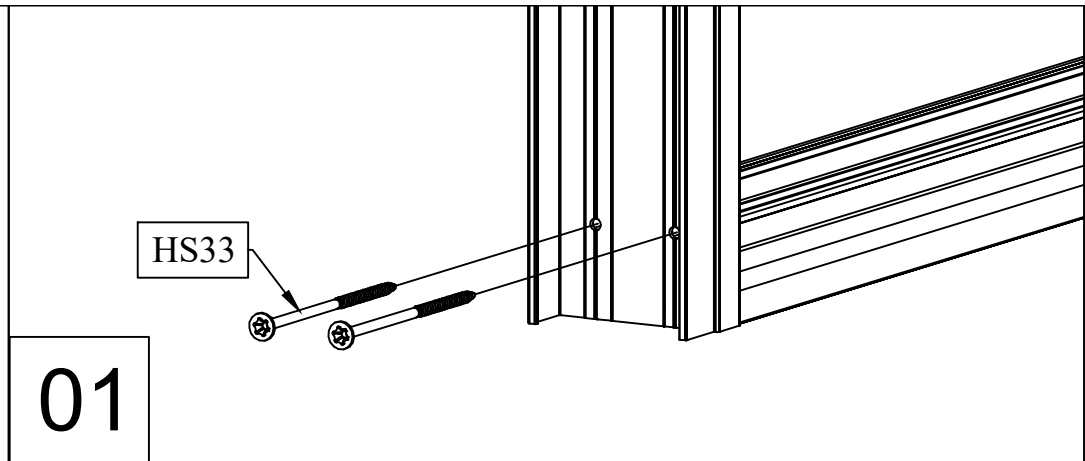
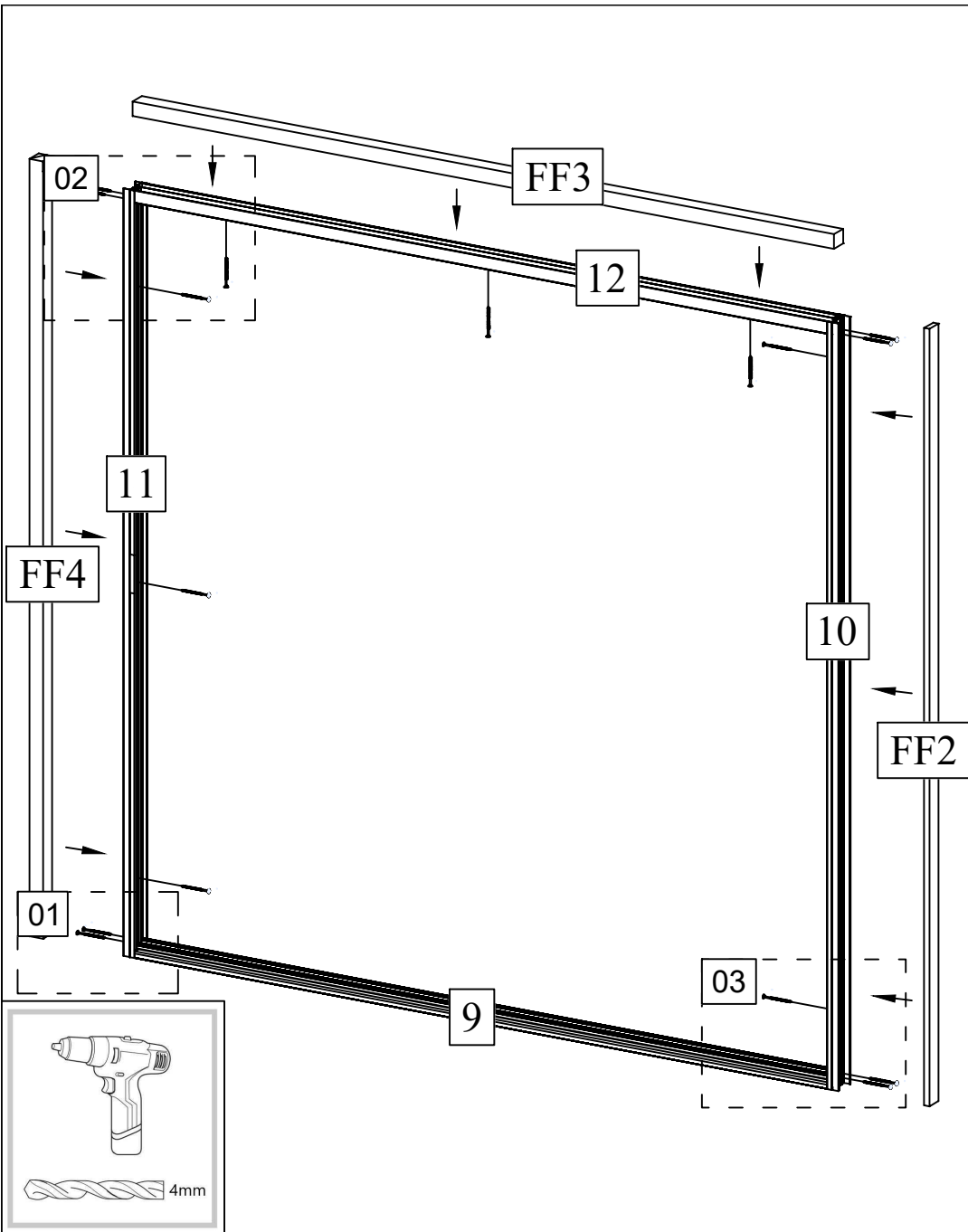

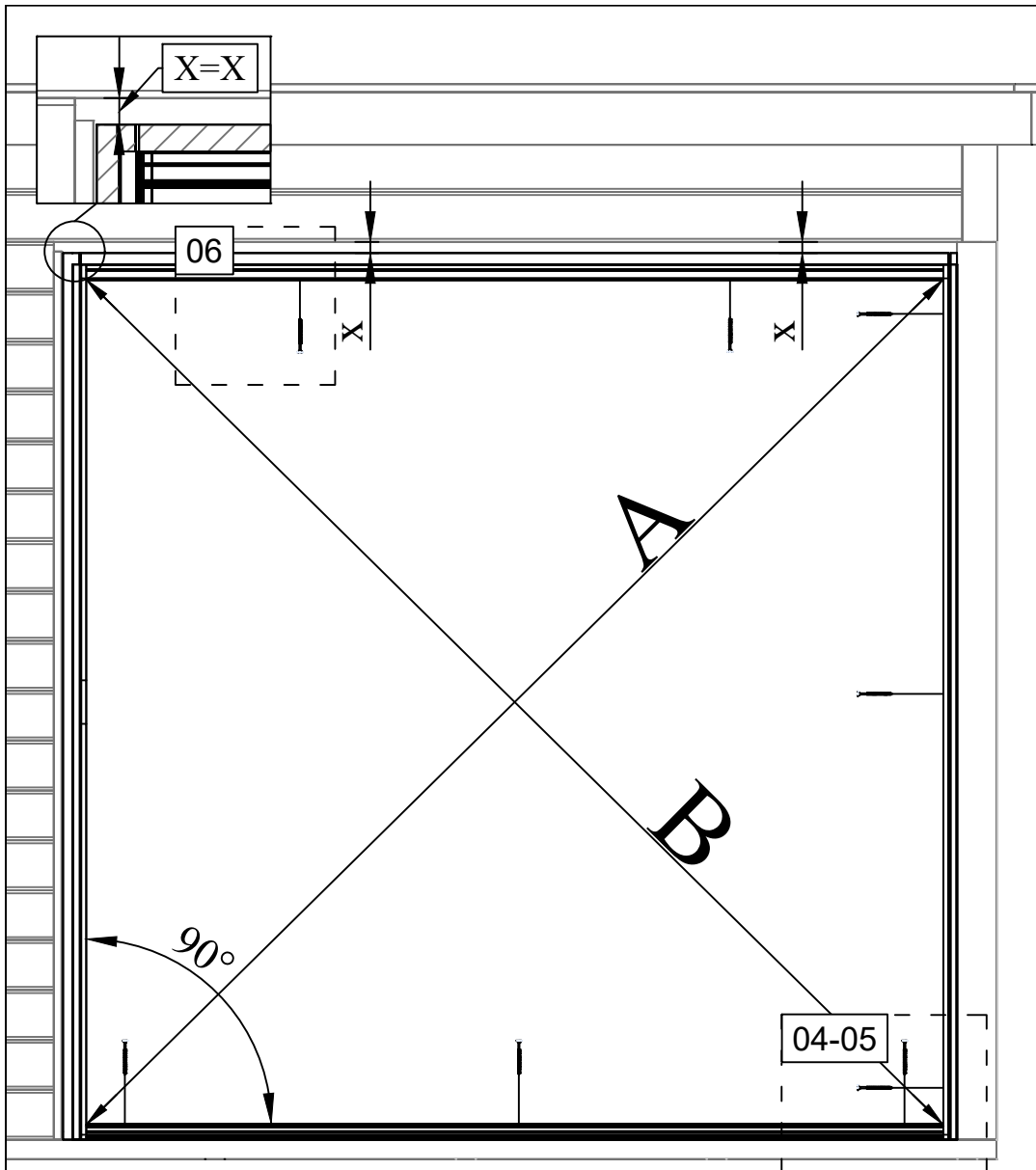

**A=B**

**04**

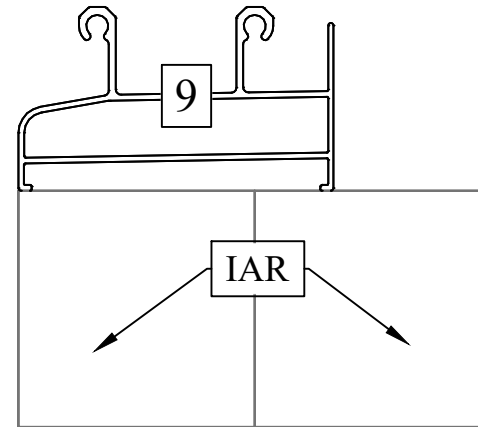

**05**

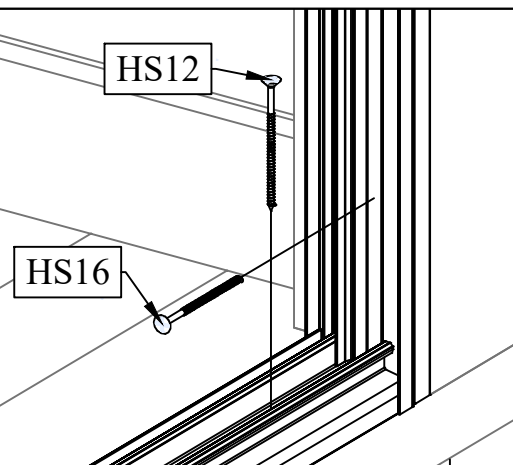

**06**

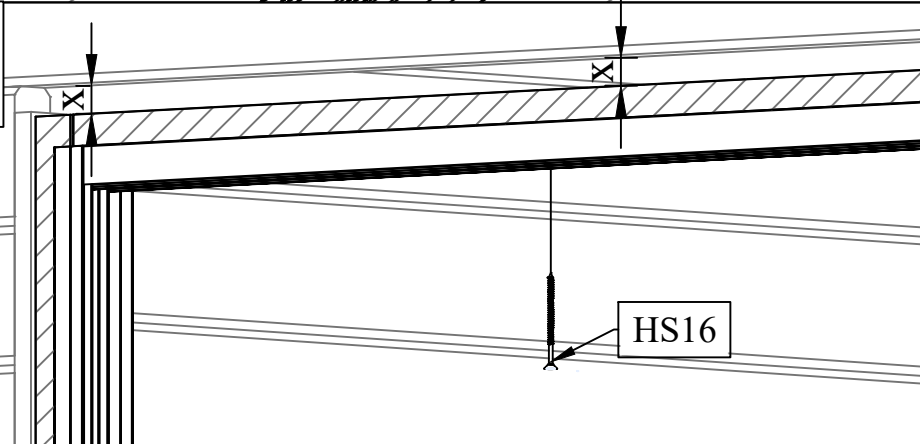



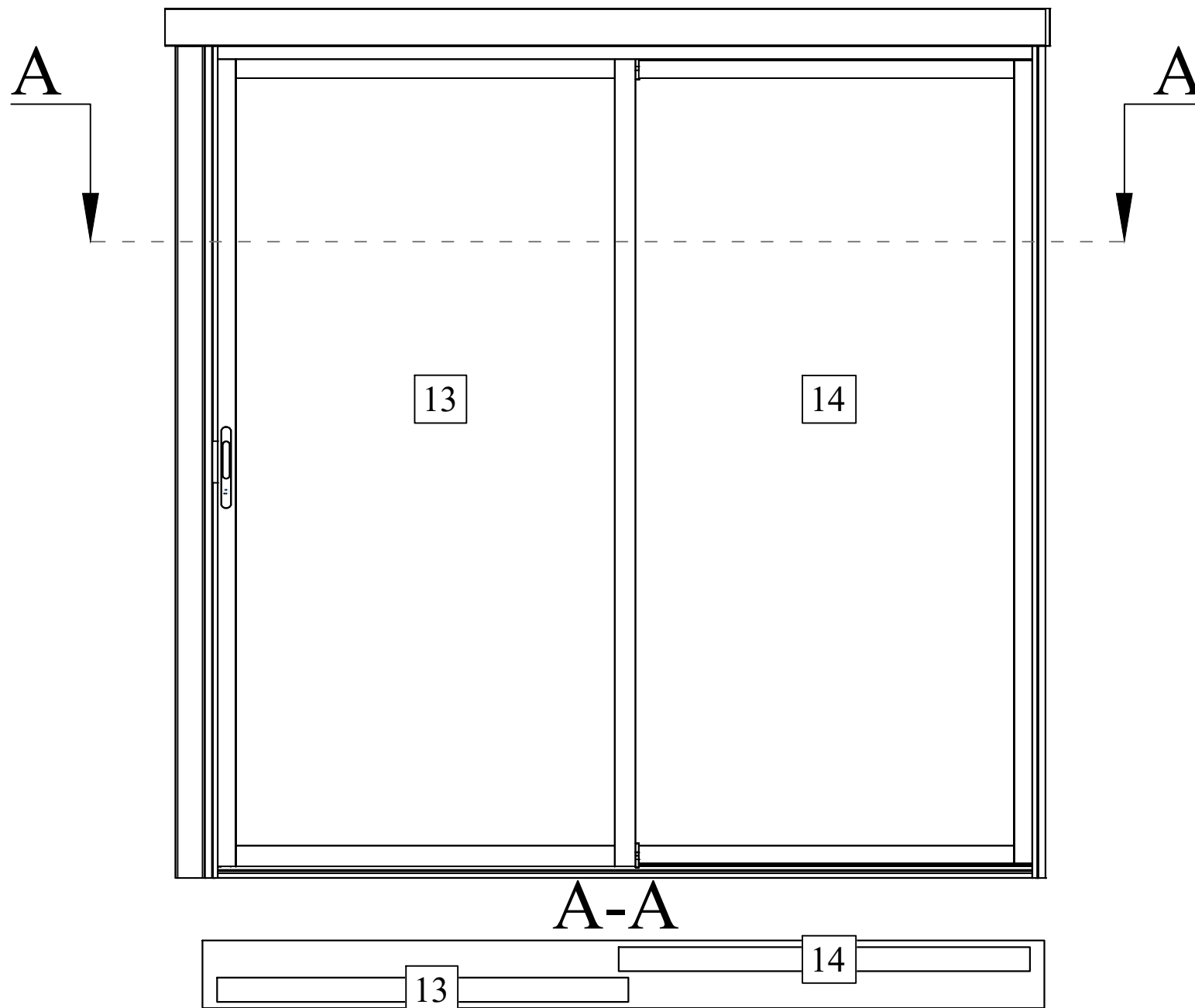

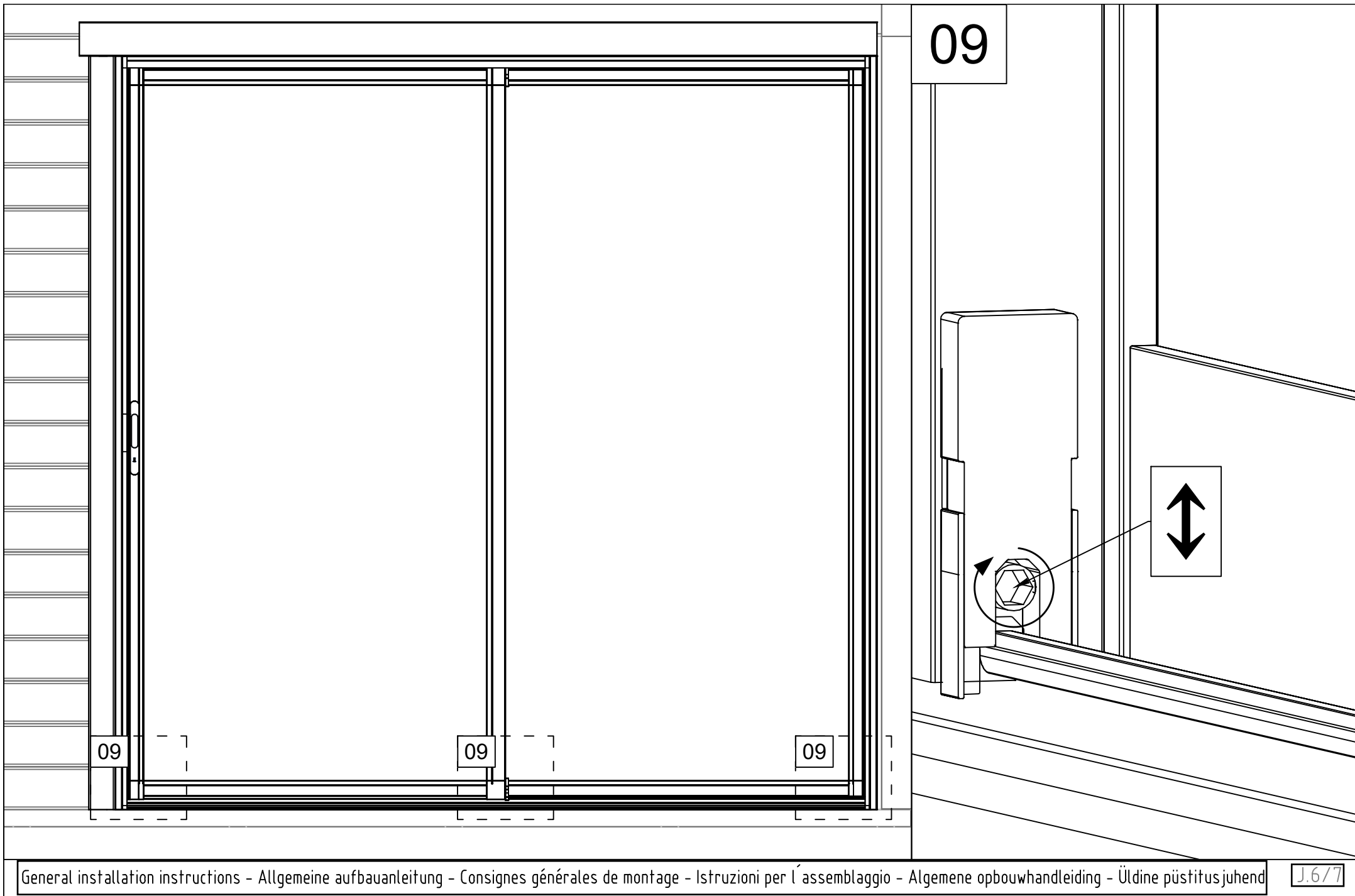

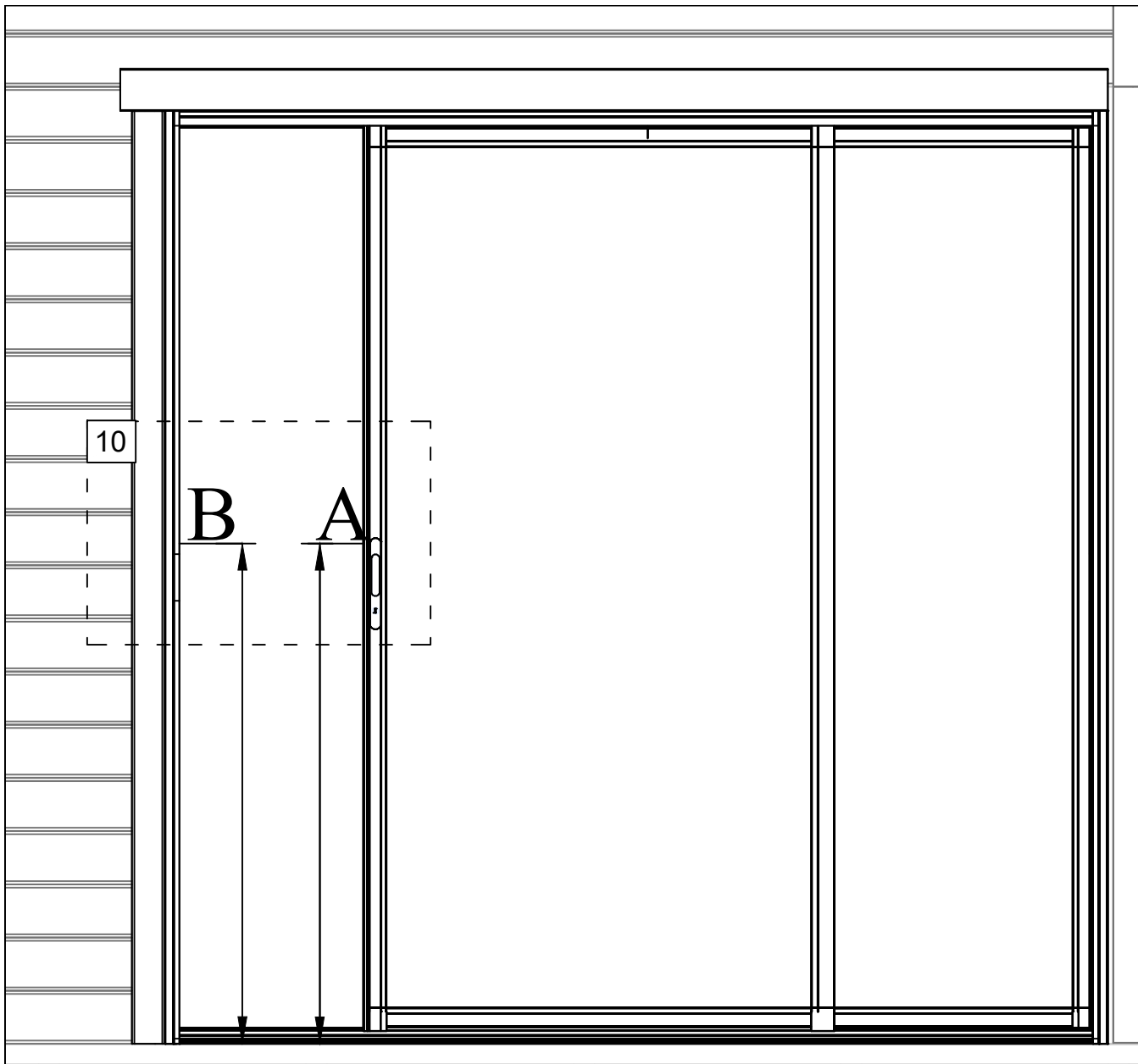

$$A=B$$

10

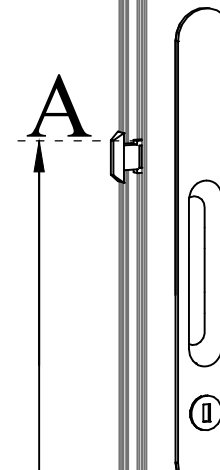

10

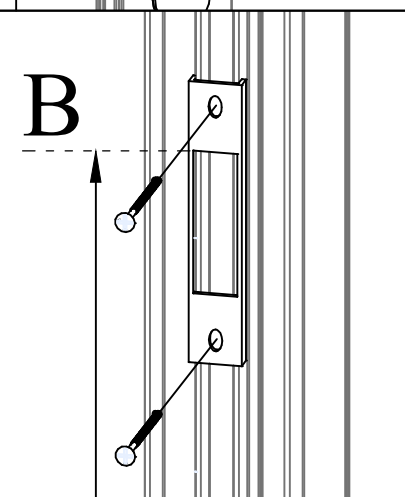

B

