

LUXOR V
2501/8300
8100/2501

- | | | | |
|-----------|--------------------------------------------------------|-----------|-----------------------------------------------------|
| D | MONTAGEANLEITUNG
BEDIENUNGSANLEITUNG | GB | ASSEMBLY INSTRUCTIONS
INSTRUCTION MANUAL |
| NL | HANDLEIDING VOOR DE MONTAGE
GEBRUIKSAANWIJZING | PL | INSTRUKCJA MONTAŻU
INSTRUKCJA OBSŁUGI |
| TR | MONTAJ TALIMATI
KULLANIM KLAVUZU | RU | ИНСТРУКЦИЯ ПО МОНТАЖУ
ИНСТРУКЦИЯ ПО ЭКСПЛУАТАЦИИ |
| RO | INSTRUCȚIUNI DE INSTALARE
INSTRUCȚIUNI DE UTILIZARE | IT | ISTRUZIONI DI MONTAGGIO
MANUALE DI ISTRUZIONI |
| FR | NOTICE DE MONTAGE
MANUEL INSTRUCTIONS | SK | MONTÁŽNY NÁVOD
NÁVOD NA POUŽITIE |
| HU | KÖZGYŰLÉS UTASÍTÁSOK
KEZELÉSI UTASÍTÁS | CZ | MONTÁŽNÍ NÁVOD
NÁVOD K POUŽITÍ |
| SI | NAVODILA ZA MONTAŽO
NAVODILA ZA UPORABO | PT | INSTRUÇÕES DE MONTAGEM
MANUAL DO USUÁRIO |
| ES | INSTRUCCIONES DE MONTAJE
MANUAL DEL USUARIO | HR | UPUTE ZA MONTAŽU
UPUTE ZA UPOTREBU |

F/B

200901

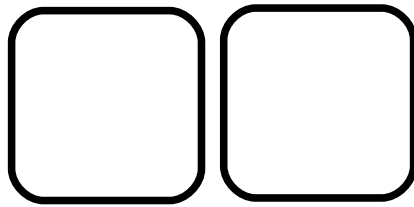

0088

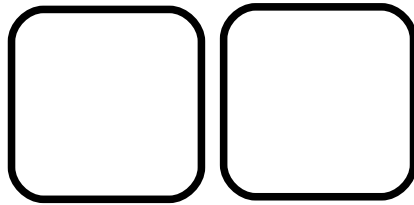
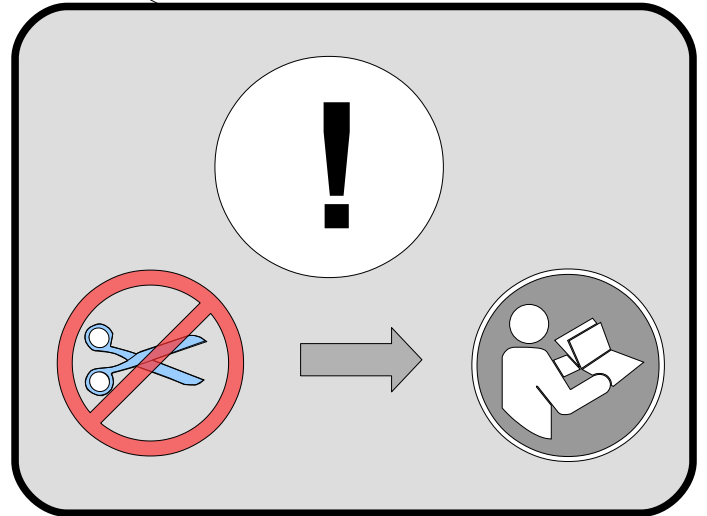
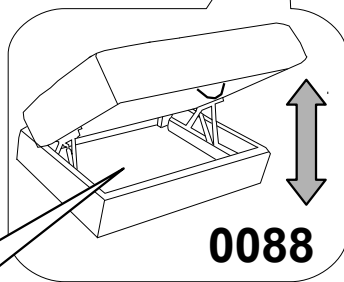
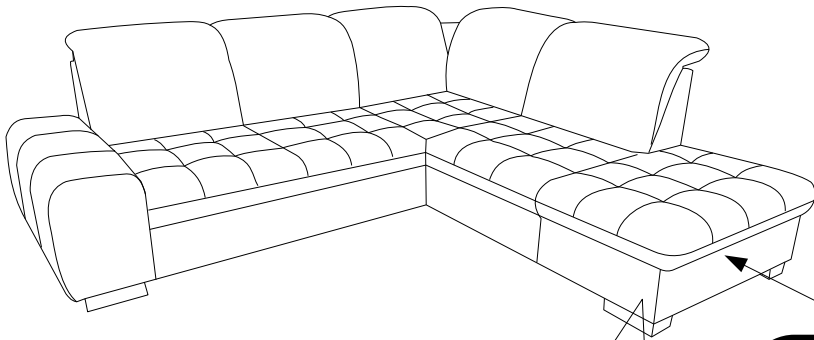

0019

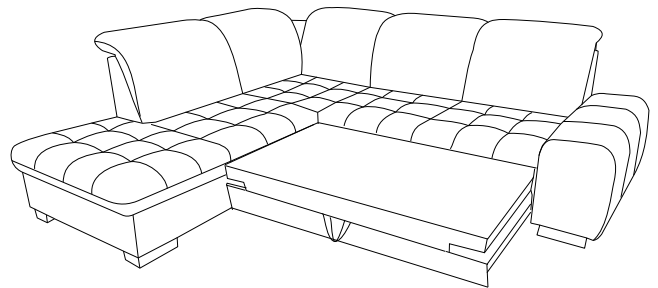
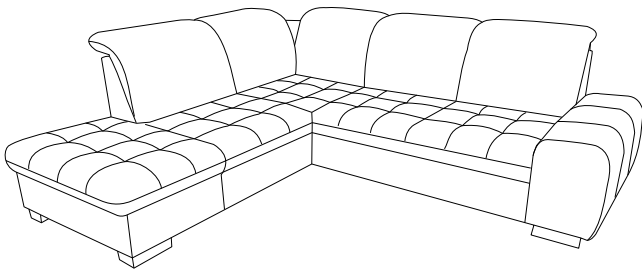

0019

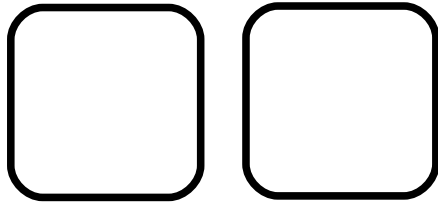

0064

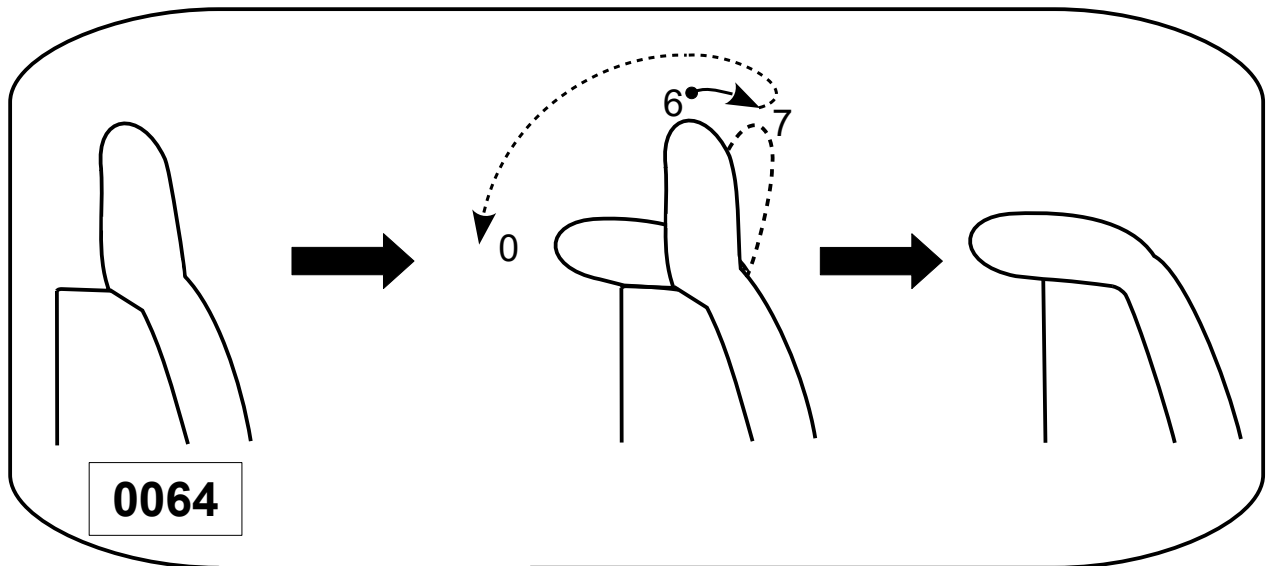
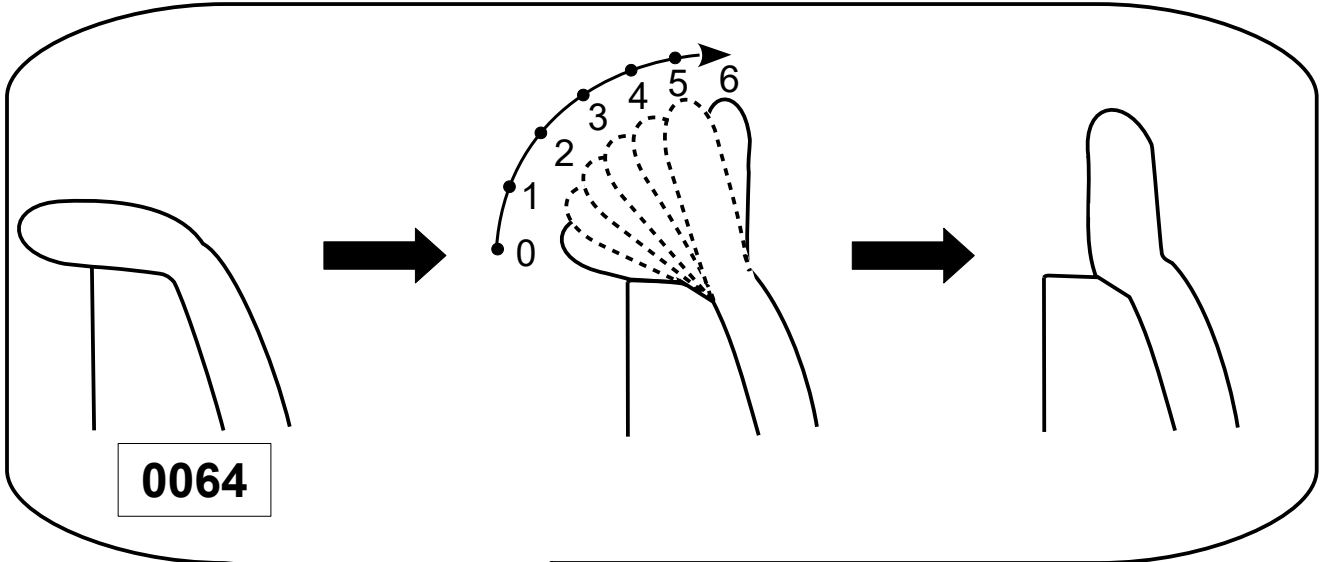

R

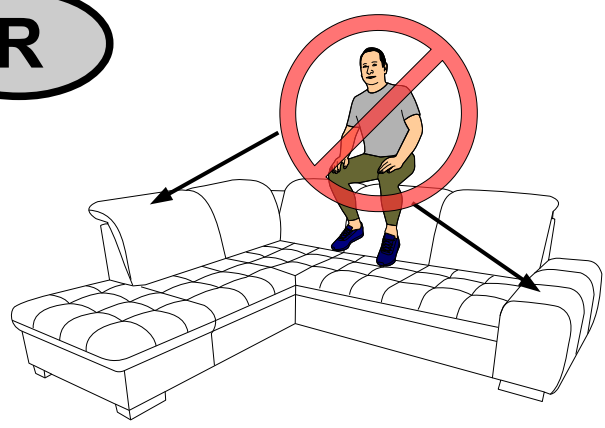

L

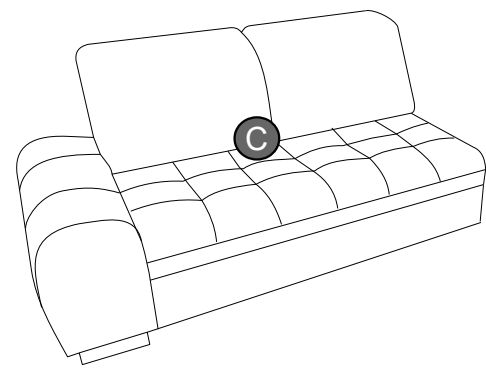
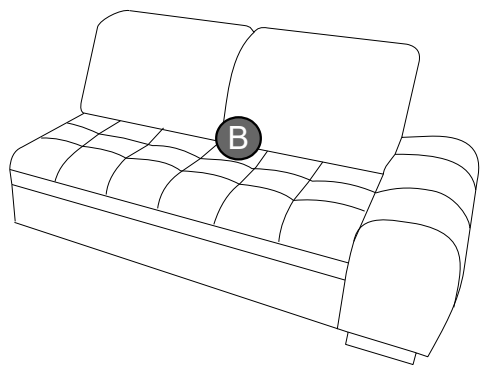
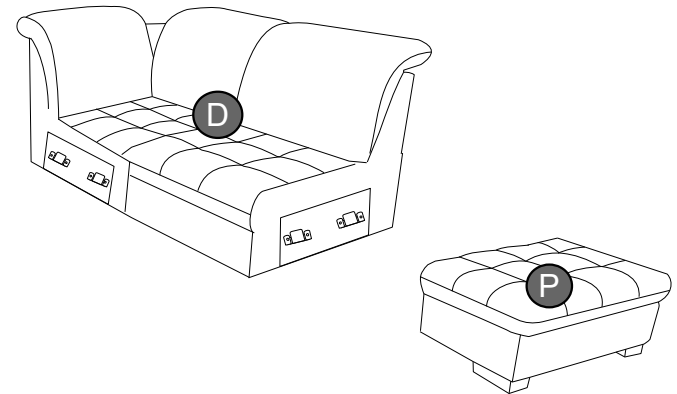
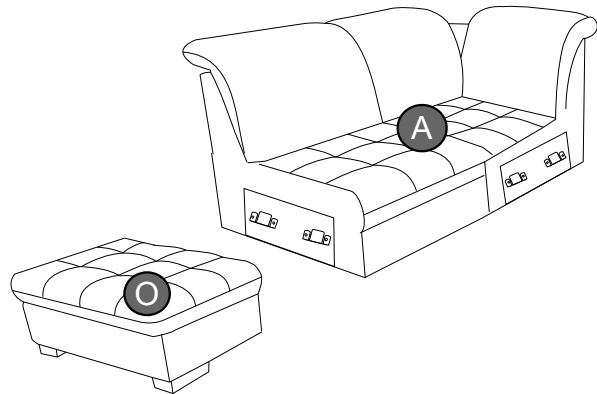
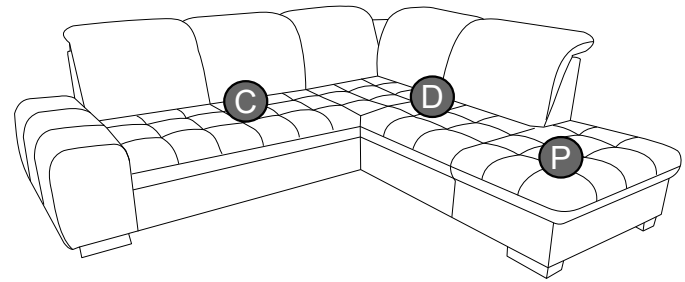
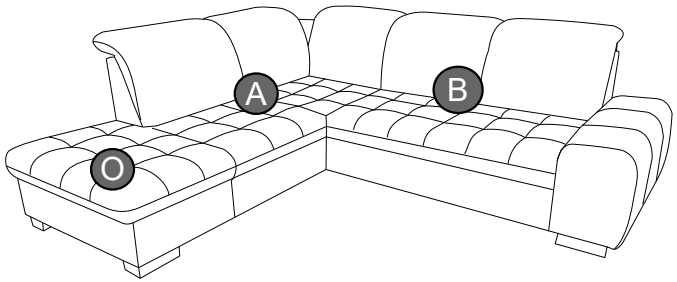
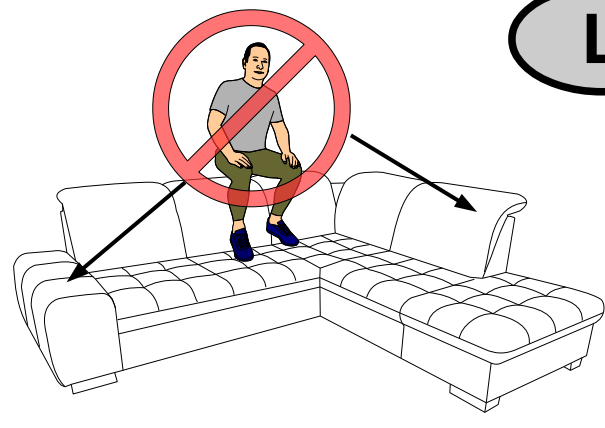

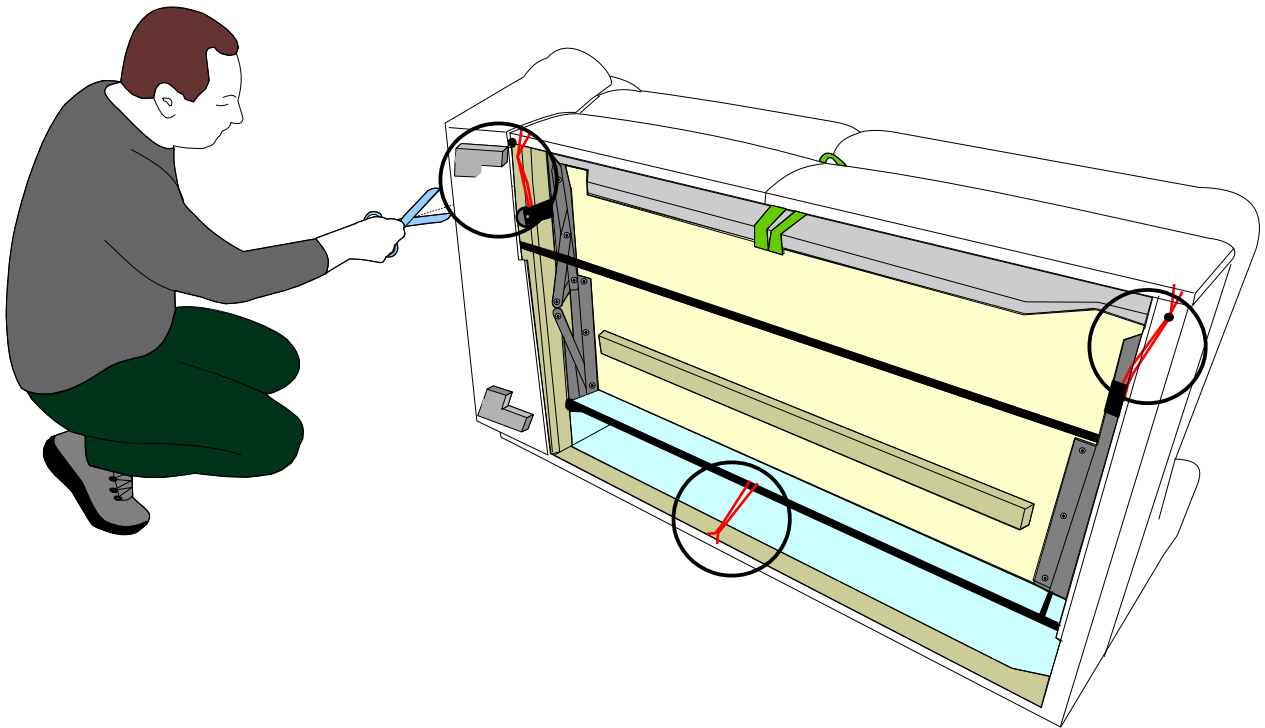
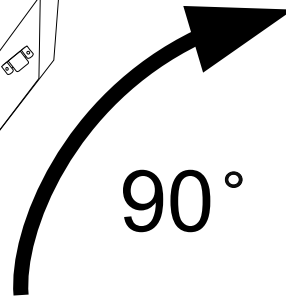

0019

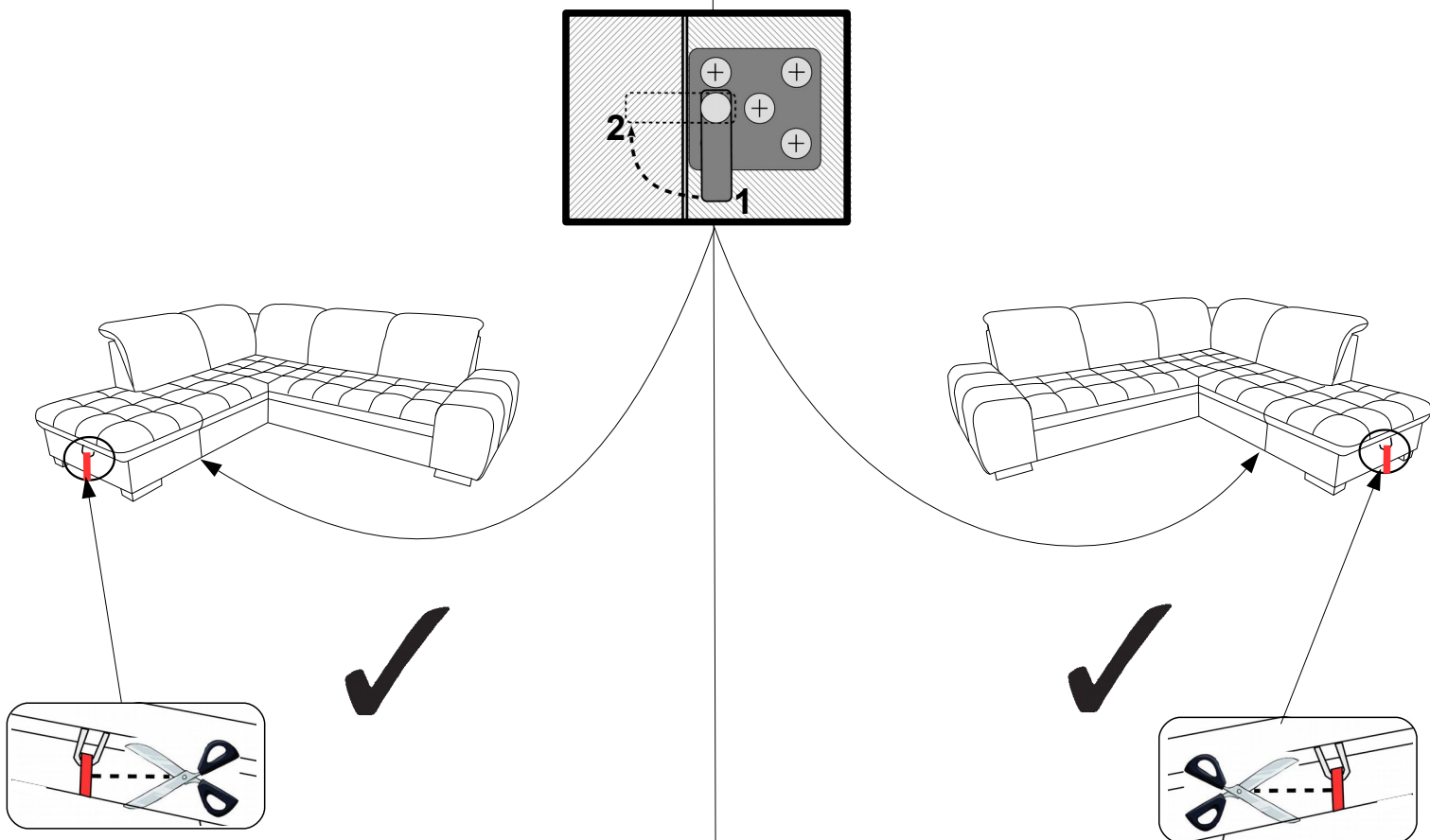
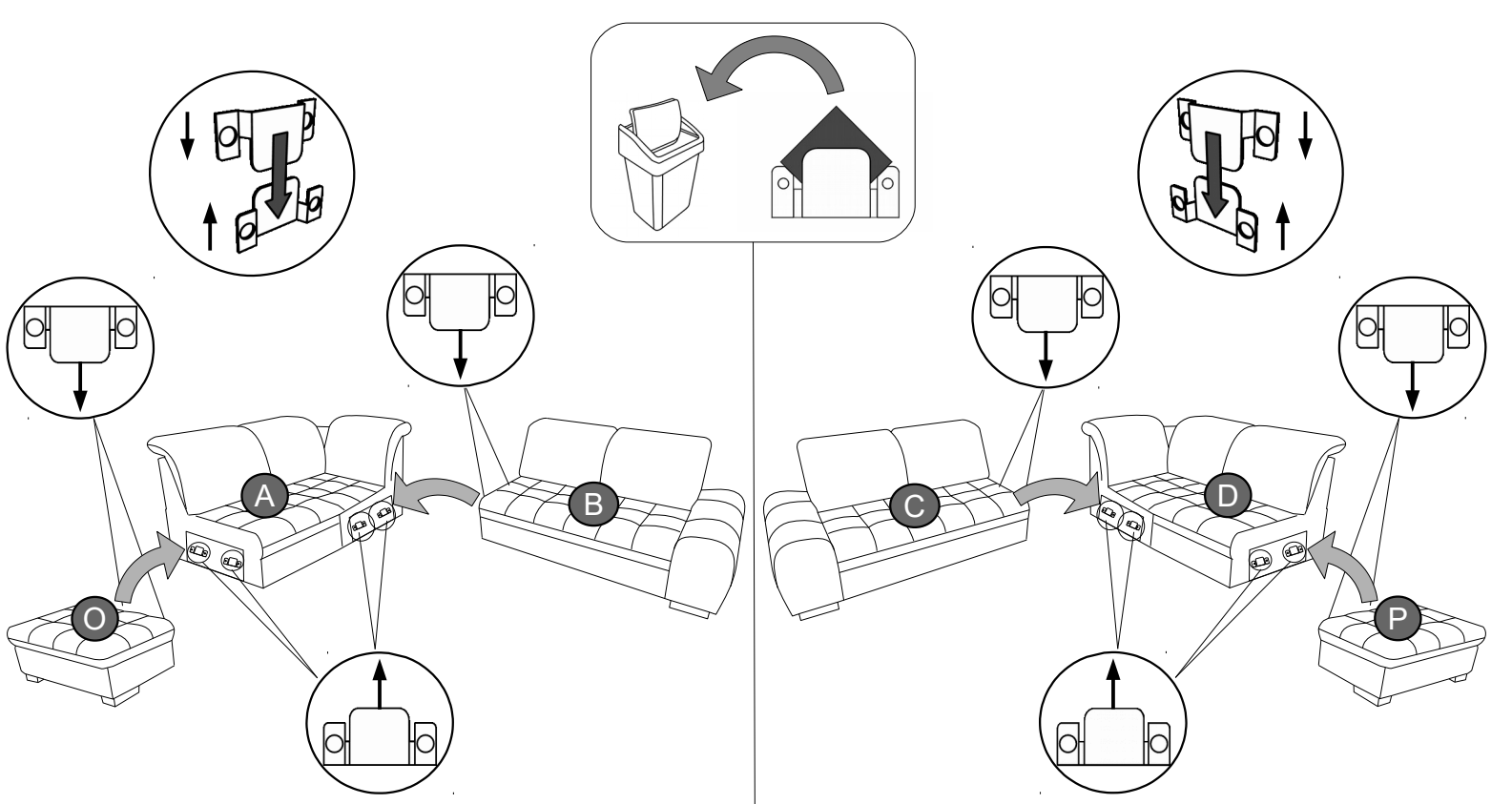

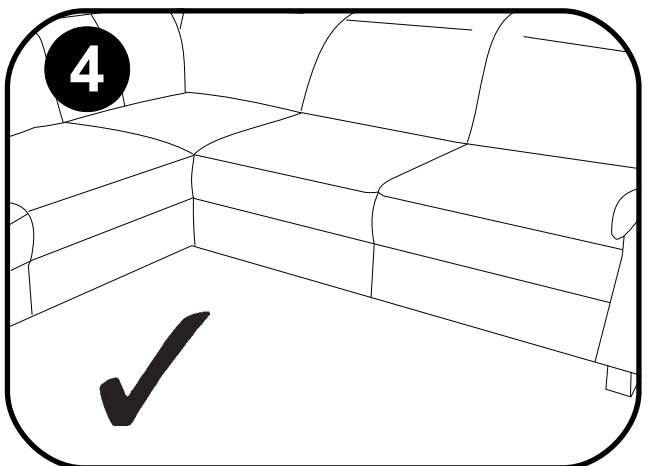
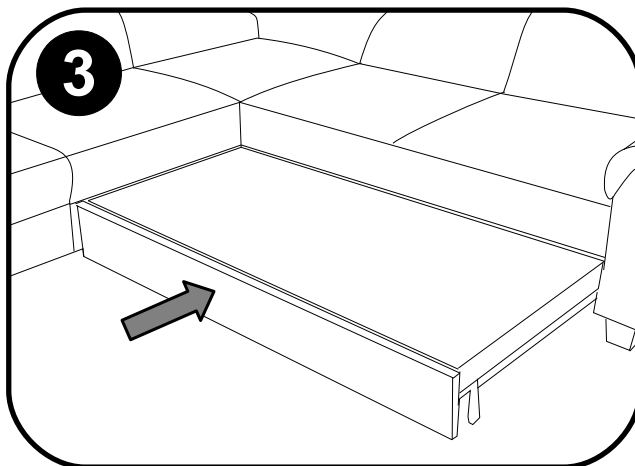
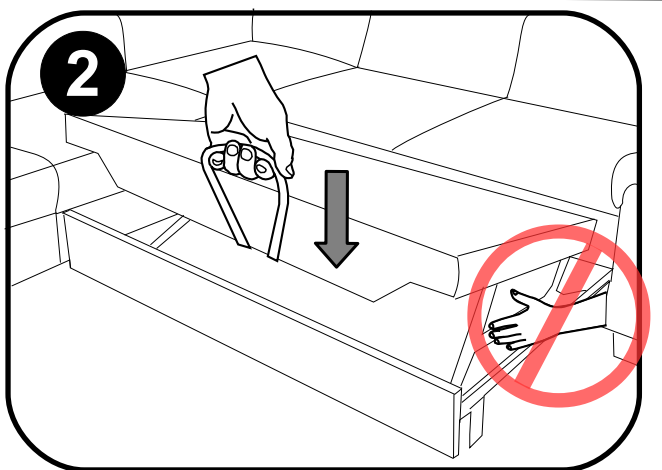
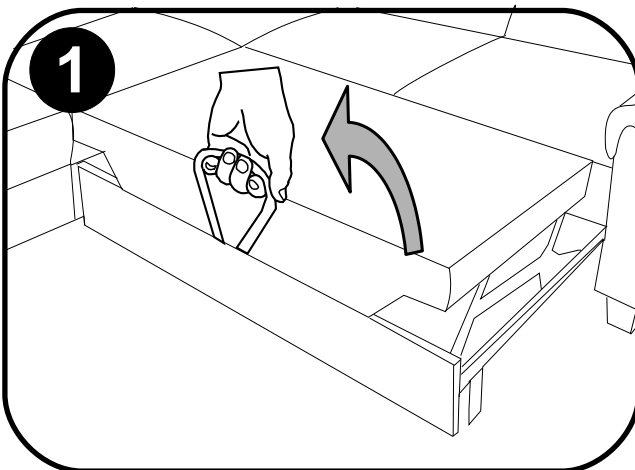
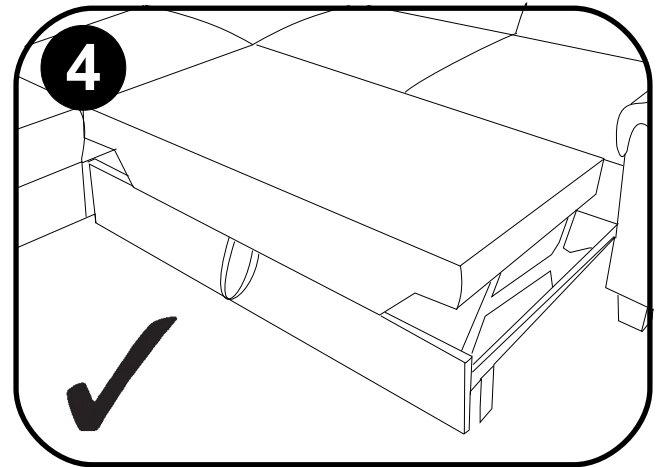
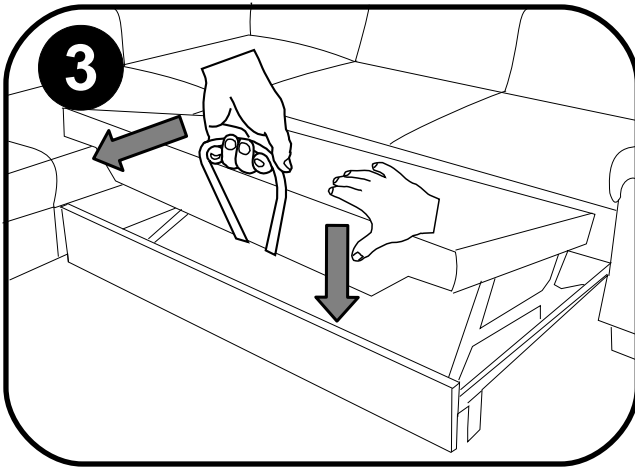
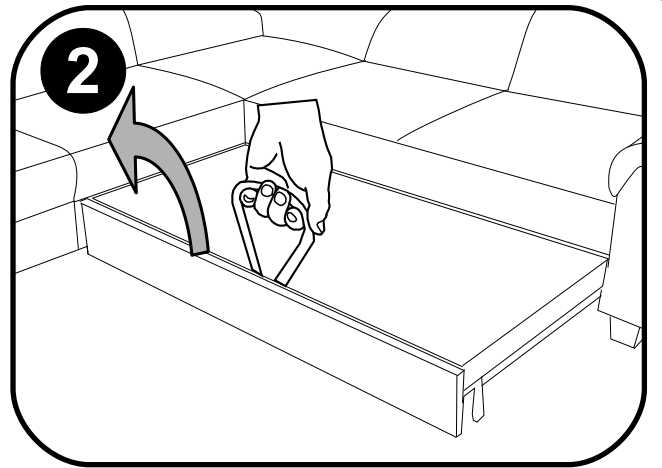
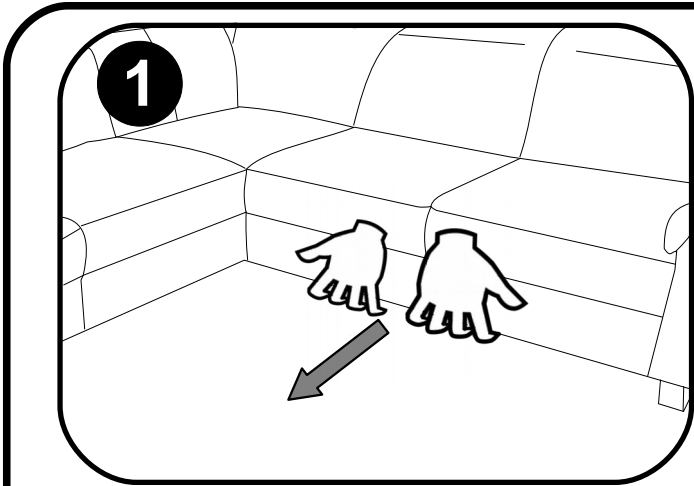
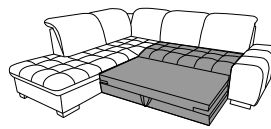
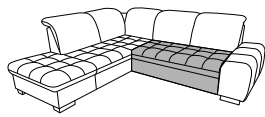

Name · Naam · Nazwa · Ísim · Название · Nume · Nome · Názov · Názov ·
 Název · Neve

LUXOR V

Typ · Type · Tip · Тип · Tipo · Típus

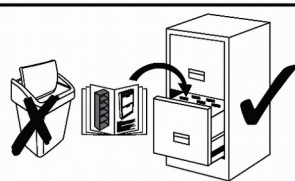
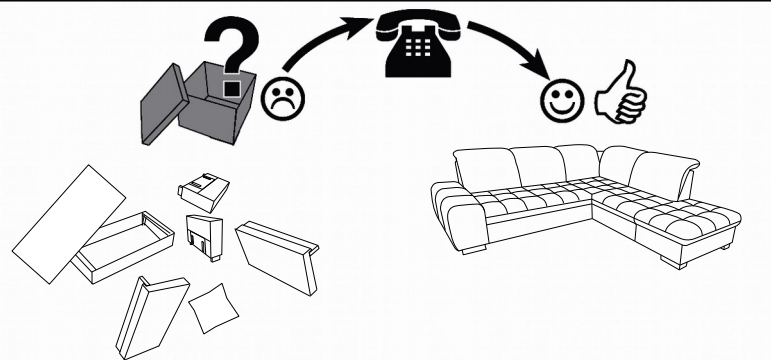

R

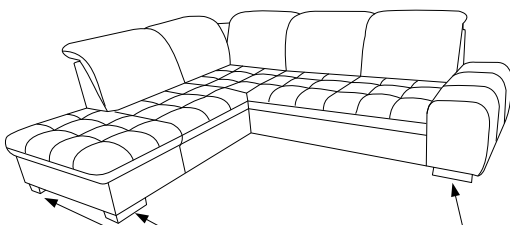

L

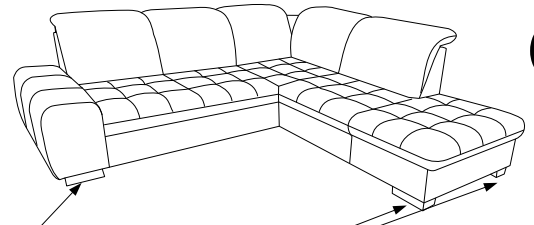

q 5*70 	x H-60 	z H-60 	h 5*35 [mm]
-------------------	-------------------	-------------------	------------------------

