

# Assembly Instruction

---

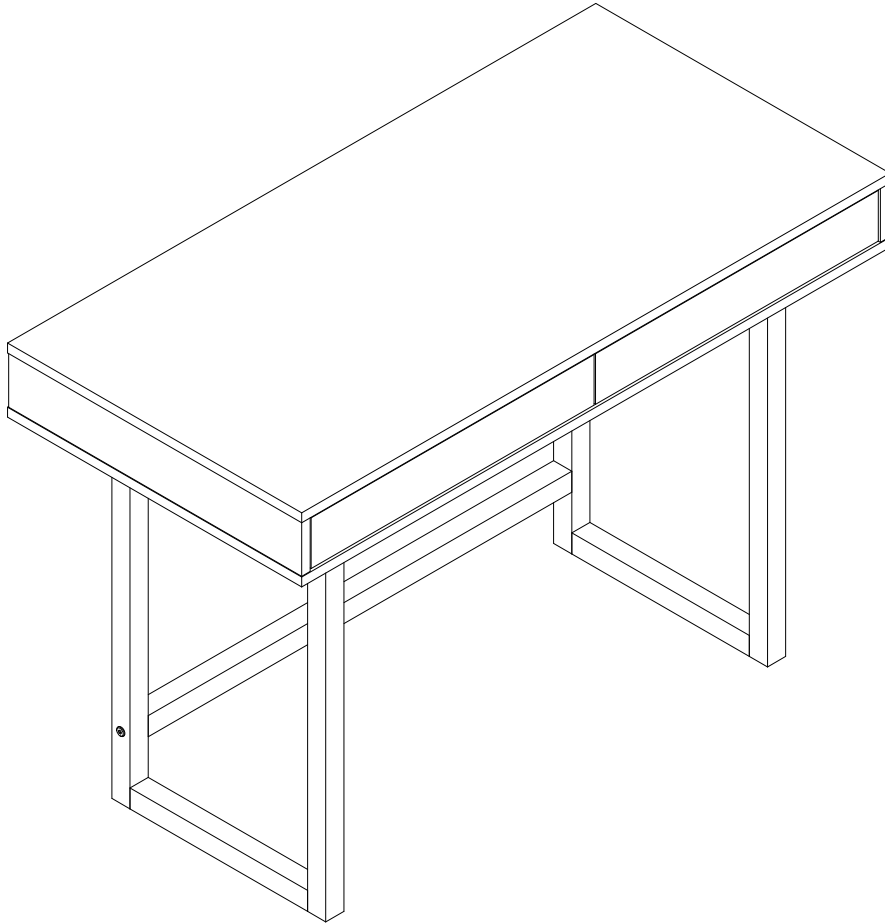

---

1100 x 550 x 760 (L x W x H, mm)

---

Batch code:



Woodman OÜ

Made in Estonia

Mäo, Järvamaa

[www.woodman.ee](http://www.woodman.ee)

[support@woodman.ee](mailto:support@woodman.ee)

# Dear Customer

Congratulations on your new purchase. Follow this advice and get the best result when assembling the product.

Read the instruction carefully before you start  
Get help, if two or more persons are required for assembly  
Make sure you have all parts on the total material list  
Work on a soft, flat surface to avoid any damage to the finish

Follow the assembly instruction  
Tighten the furniture joints after a month  
Keep the assembly instruction

Allocate time

Some furniture can be assembled in minutes. Others - e.g. products in several parts - can take more than an hour to finish. Make sure to allocate good time or divide up the work

---

## Tools needed

---

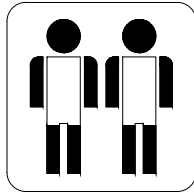
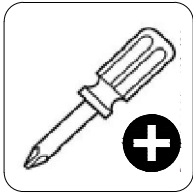

---

## Do not use !!!

---

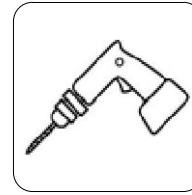





ENG - In case of any quality issues contact your local dealer and always mention item reference No.

FR - En cas de problèmes de qualité contactez votre revendeur local et mentionnez toujours la référence de l'article.

IT - In caso di eventuali problemi di qualità contattare il rivenditore locale e citare sempre punto di riferimento No.

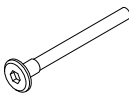
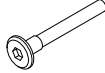

ES - En caso de problemas de calidad pongase en contacto con su distribuidor local y mencione siempre la referencia del artículo.

DE - Wenn Sie Qualitätsprobleme haben wenden Sie sich bitte an ihren örtlichen Händler und erwähnen Sie immer die Artikelnummer.

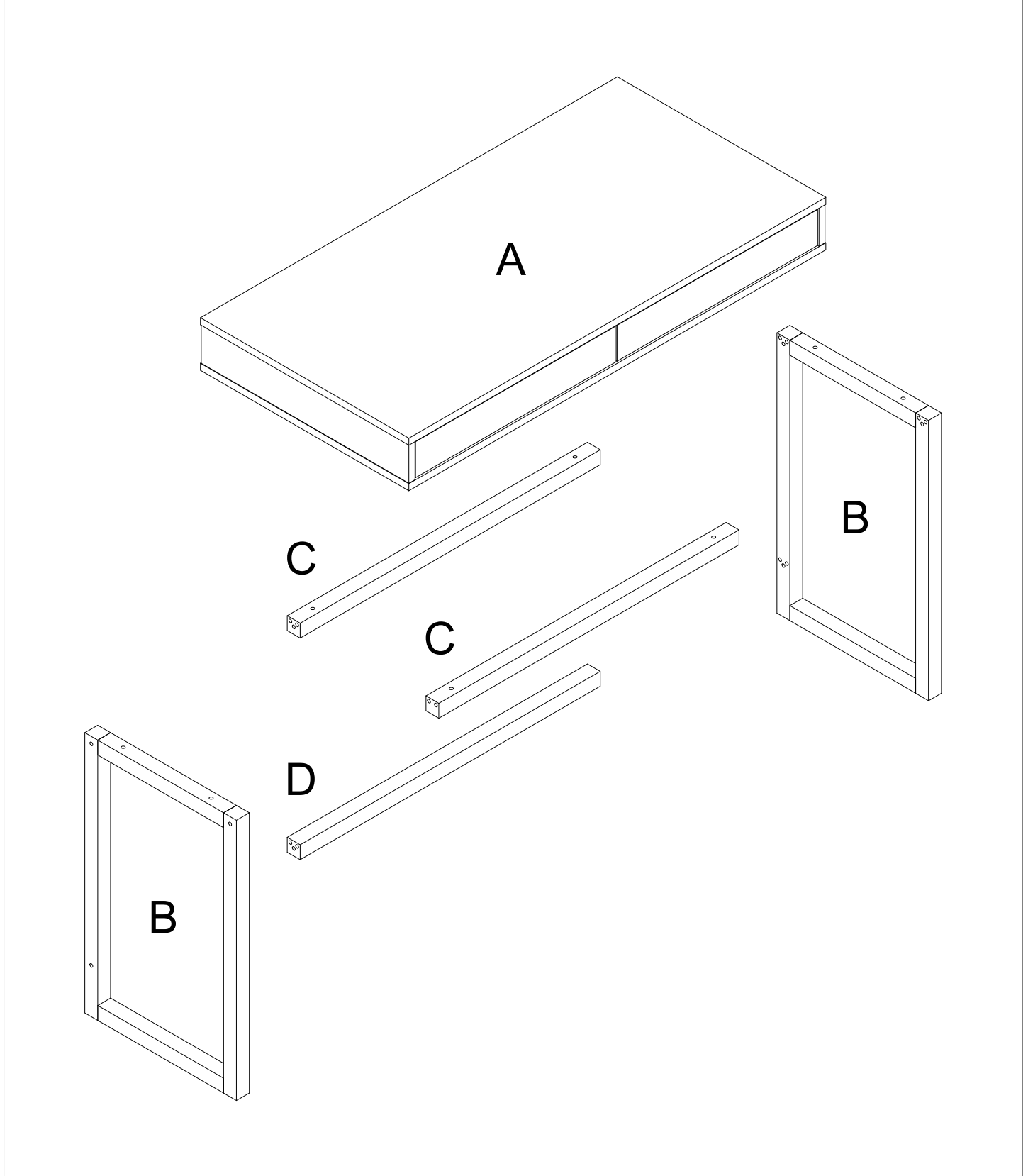
A1	 x12 Ø8x35	A2	 x6 Ø6x10x13	A3	 x6 Ø6x60	A4	 x8 Ø6x45
A5	 x4 Ø28x3	A6	 x1 4mm				

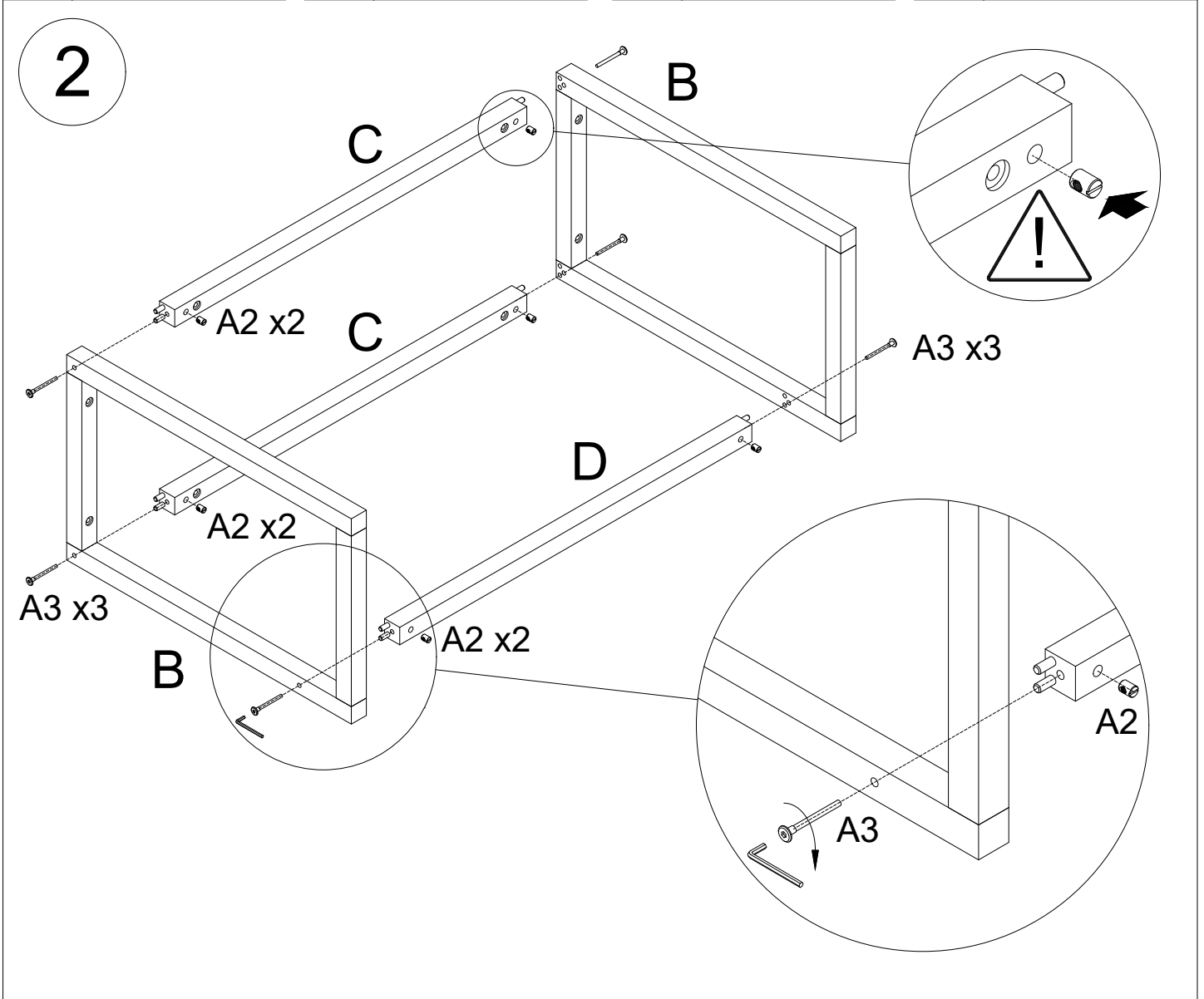
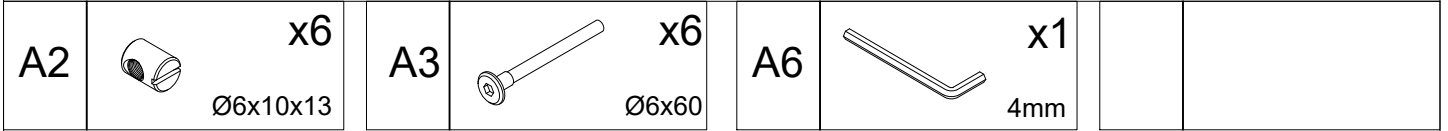
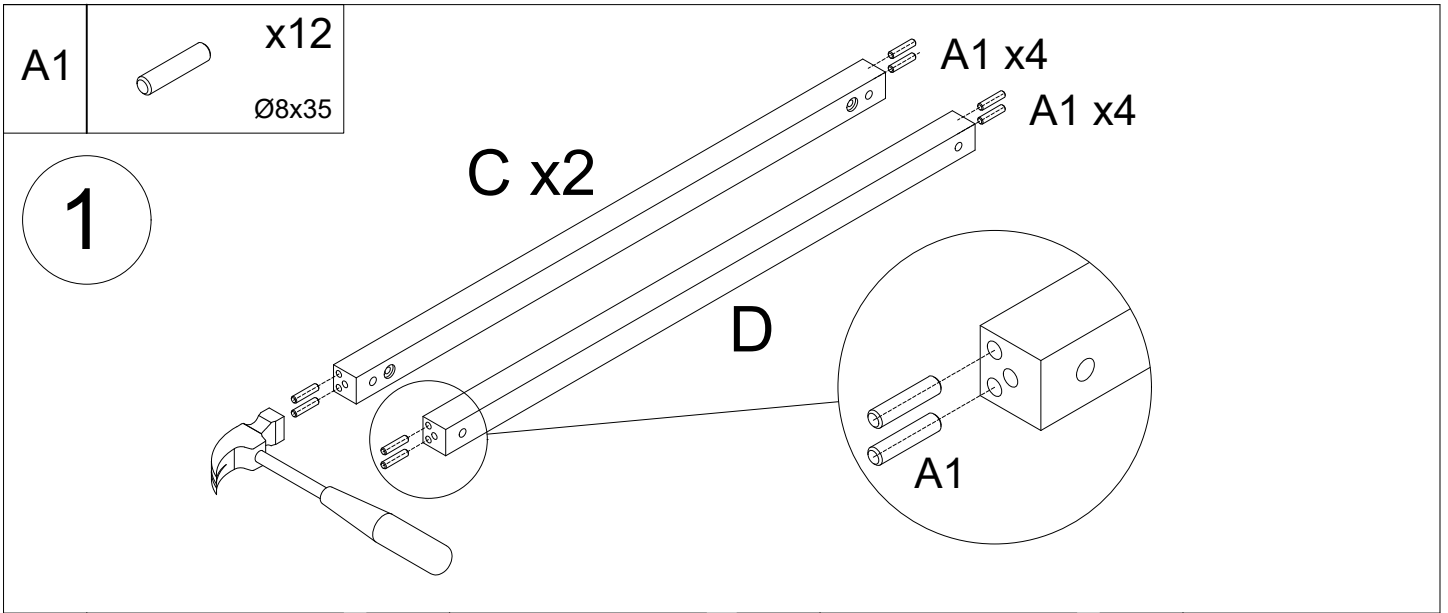

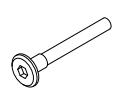

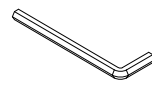
A4	 x8 Ø6x45	A5	 x4 Ø28x3	A6	 x1 4mm		
----	--	----	--	----	---	--	--

