

CHELSEA HOCKER 80x80

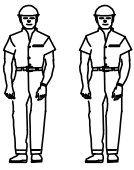

15min



(D) Montageanleitung

(NL) Handleiding voor de montage

(TR) Montaj talimati

(F) Notice de montage

(CZ) Montážní návod

(GB) Assembly instructions

(HU) Szerelési útmutató

(PL) Instrukcja montażu

(RU) Инструкция по монтажу

(IT) Istruzioni di montaggio

(SK) Návod na montáž

(RO) Instrucțiuni de montaj

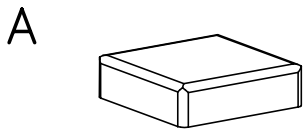
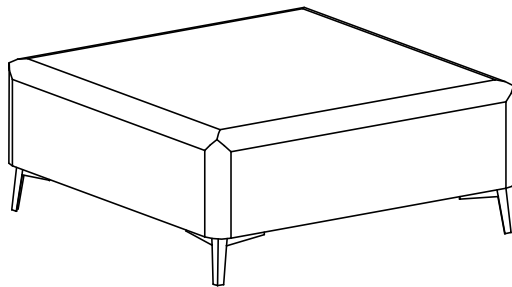
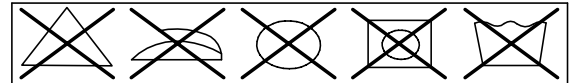

x1

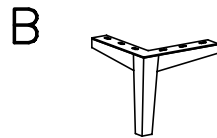

x4

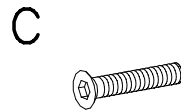

x24

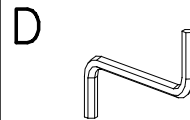

x1

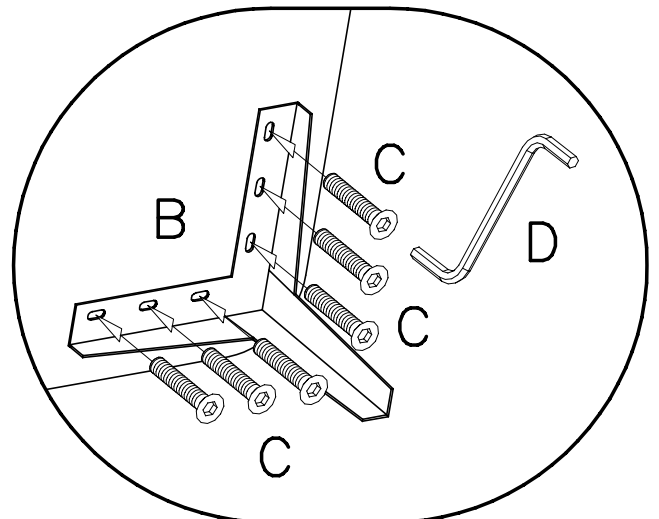
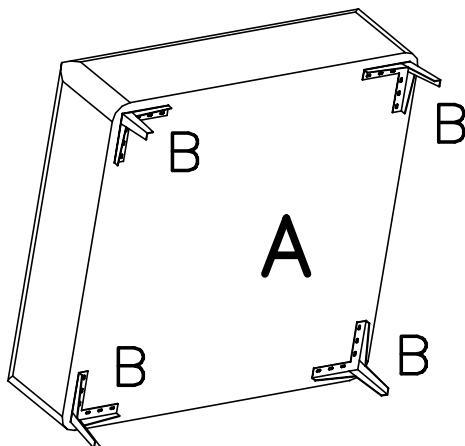
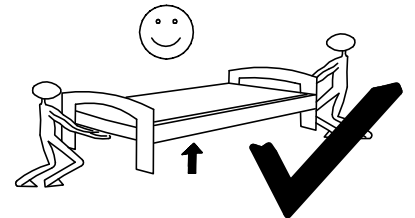
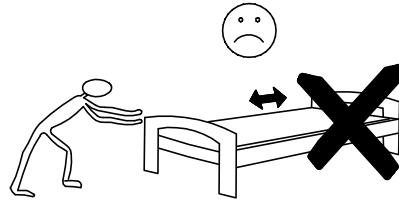
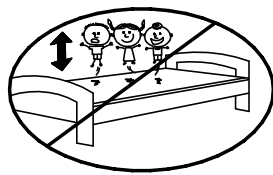
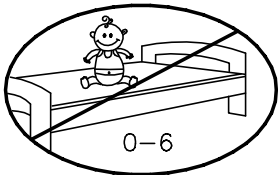

Service • Assistenza • Dienstverlening • Serwis •
 Servis • Szerviz • Сервисная служба

Name • Nom • Nome • Naam • Nazwa • Jméno • Název • Név • Denimire • Isim • Название	CHELSEA
Nr • No. • N° • Номер • Č • Sz	80x80
Type • Tipo • Típus • Typ • Тип • Тір	HOCKER

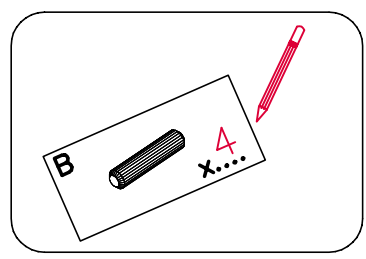
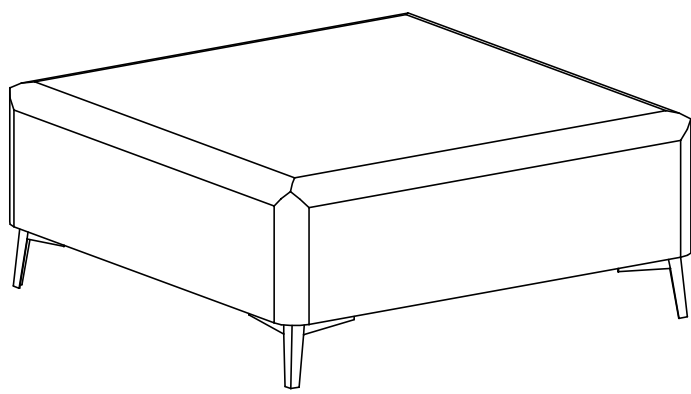
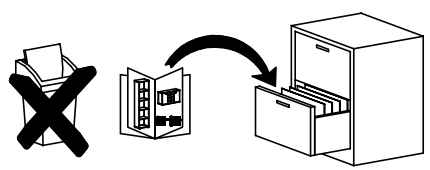
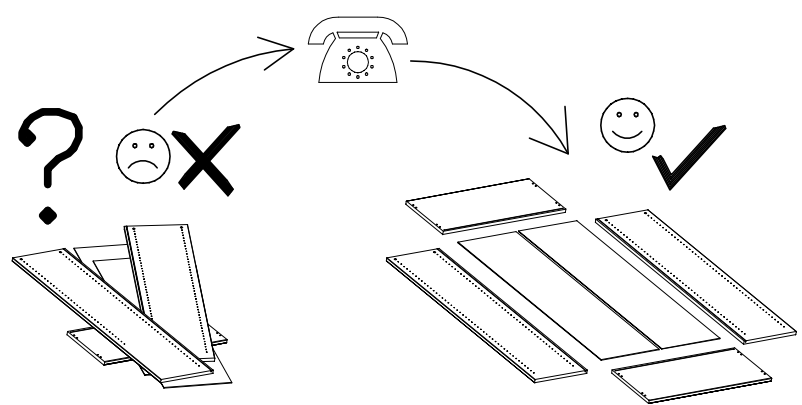

- | | | | | | | | |
|---|------|---|------|---|------|---|------|
| A | x... | B | x... | C | x... | D | x... |
|---|------|---|------|---|------|---|------|